

HALO offers a broad range of 10BASE-T filters for single and multiport applications. Filters include isolation transformers, low pass filters and optional CMR chokes and are available for most IC's requiring low pass filters to meet the IEEE 802.3 insertion and return loss specifications. For additional information please contact your local HALO representative.

Vendor	Silicon Part Number	Transformers and Filters	Transformers Tx Choke and Filters	Transformers Tx / Rx Chokes and Filters	Transformers Tx / Rx Chokes Filters & Resistors
AMD	Am79C98	FD02-101G	FD12-101G	FD22-101G	FD22-101R2
AMD	Am79C940	FD02-101G	FD12-101G	FD22-101G	FD22-101R2
AMD	Am79C961/5A	FD02-101G	FD12-101G	FD22-101G	FD22-101R2
AMD	Am79C970A	FD02-101G	FD12-101G	FD22-101G	FD22-101R2
AMD	79C981/2	FD02-101G	FD12-101G	FD22-101G	FD22-101R2
AMD	Am79C100	FD02-101G	FD12-101G	FD22-101G	FD22-101R2
DEC	21040	FD02-114G	FD12-114G	FD22-114G	–
Galileo	GT-48001	FD02-101G	FD12-101G	FD22-101G	–
Intel	82503 / 82595	FD02-101G	FD12-101G	FD22-101G	–
LSI	L64381	FD02-101G	FD12-101G	FD22-101G	–
Micro Linear	ML465( )	FD02-104G1	–	FD22-104G1	FD22-104R1
NSC	DP83902A	FD02-101G	FD12-101G	FD22-101G	FD22-101R1
NSC	DP83905	FD02-101G	FD12-101G	FD22-101G	FD22-101R1
NSC	DP83934	FD02-101G	FD12-101G	FD22-101G	FD22-101R1
NSC	DP8395X	FD02-101G	FD12-101G	FD22-101G	FD22-101R1
Phillips	86C92	FD02-101G	FD12-101G	FD22-101G	–
Seeq	83C94	FD02-101G	FD12-101G	FD22-101G	–
SMSC	91C92/94	FD02-101G	FD12-101G	FD22-101G	–
TDK	TSC78Q8373	FD02-101G	FD12-101G	FD22-101G	–
TDK	TSC78Q8378	FD02-101G	FD12-101G	FD22-101G	–

SIP and “Slim” SIP packages are also available for high density repeater and switch applications.

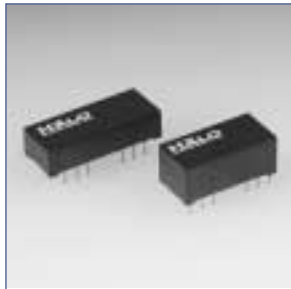

## 100Ω DIL 10BASE-T Filter Modules



HALO Electronics has developed this standard series of 100Ω filter modules to specifically address the 10BASE-T requirements of IEEE 802.3. Filter modules are available for most LAN IC manufacturer's products. To select the correct isolation module, please refer to the HALO 10BASE-T Selector Guide.

### Package G

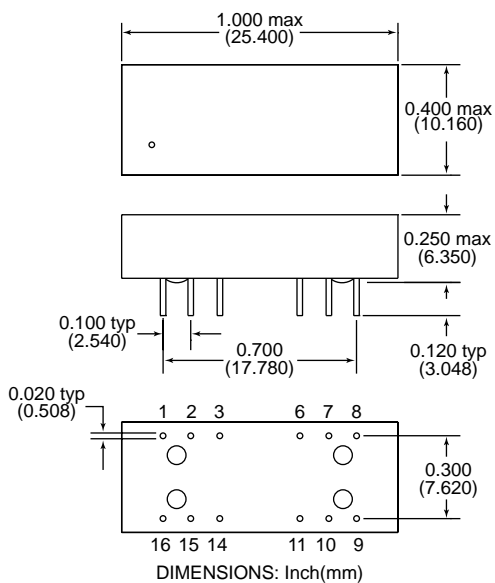

### Package H

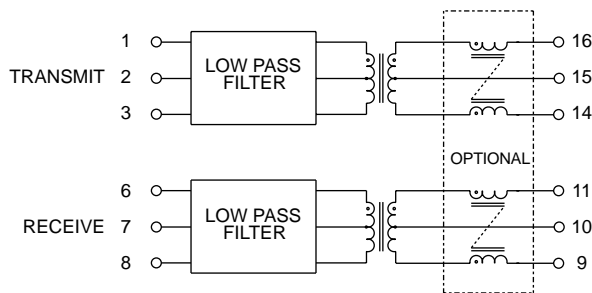
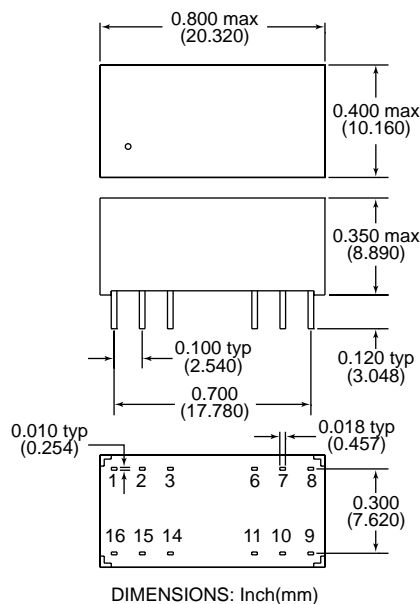

#### Electrical Specifications @ 25°C

Dielectric Withstanding Voltage: 2,000Vrms  
 Insertion Loss (5-10MHz): -1 dB Max.  
 Return Loss (5-10MHz): -20 dB Min.

#### Cross Talk (1-10MHz):

Attenuation @ 30MHz: Transmit  
 Receive

-30 dB Min.  
 -27 dB Min.  
 -18 dB Min.  
 17 MHz Typ.

#### Cutoff Frequency:

Part Number	Transmit Filter Description	Receive Filter Description	Optional CMR Chokes	Package
FD02-101G	100Ω Transformer + Filter	100Ω Transformer + Filter	-	G
FD12-101G	100Ω Transformer + Filter	100Ω Transformer + Filter	TX	G
FD22-101G	100Ω Transformer + Filter	100Ω Transformer + Filter	TX / RX	G
FD02-101H	100Ω Transformer + Filter	100Ω Transformer + Filter	-	H
FD12-101H	100Ω Transformer + Filter	100Ω Transformer + Filter	TX	H
FD22-101H	100Ω Transformer + Filter	100Ω Transformer + Filter	TX / RX	H

HALO Electronics has developed this standard series of highly integrated filter modules to specifically address the 10BASE-T requirements of IEEE 802.3. Filter modules are available for most LAN IC manufacturer's products. To select the correct filter component please refer to the HALO Electronics Filter Selection Guide.

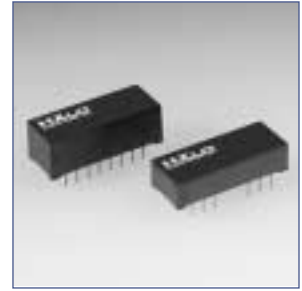

**Schematic / Package A**

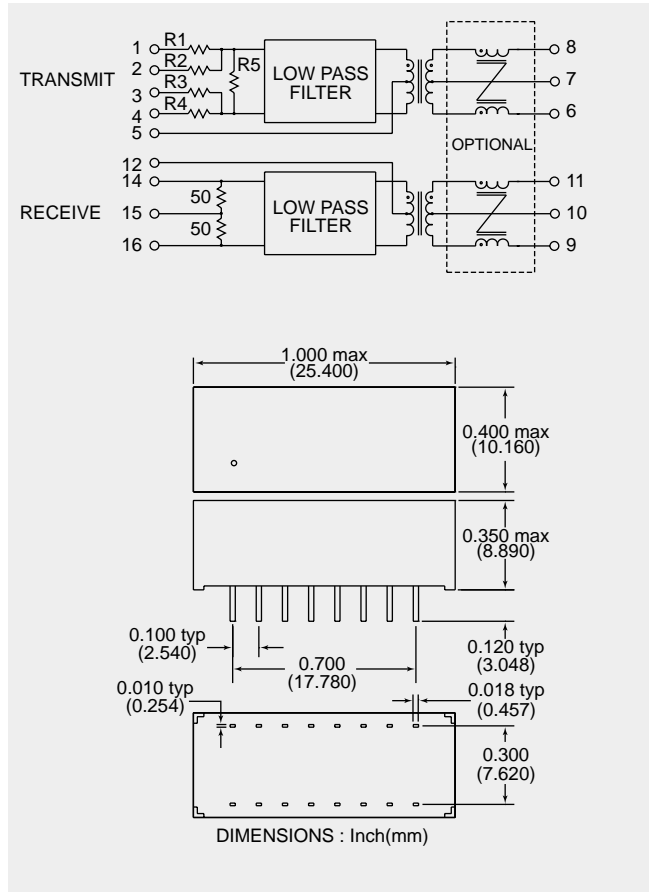

**Schematic / Package B**

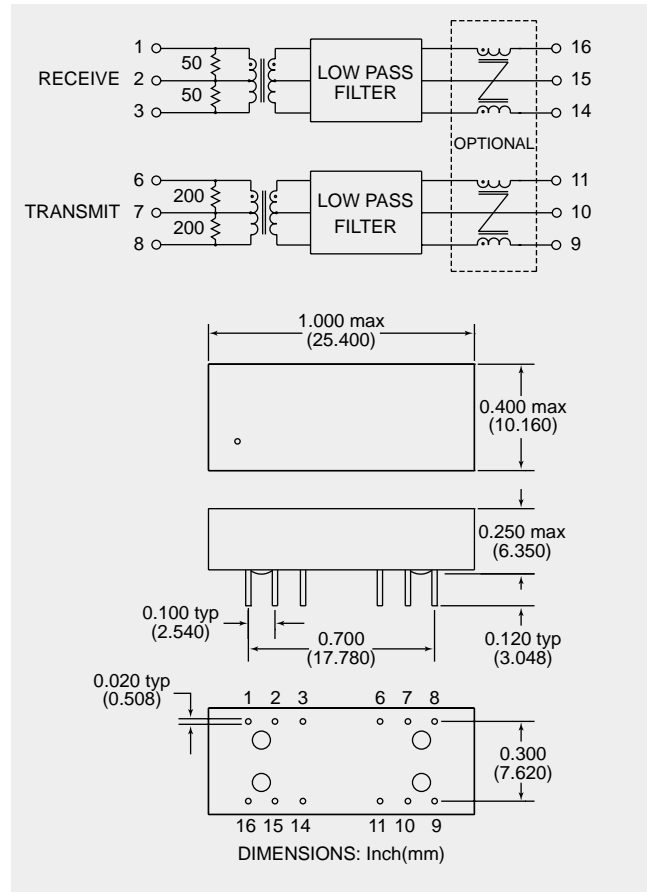

Electrical Specifications @ 25°C  
 Dielectric Withstanding Voltage: 2,000Vrms Min.  
 Insertion Loss (5-10MHz): -1 dB Max.  
 Return Loss (5-10MHz): -20 dB Min.

Cross Talk (1-10MHz): -30 dB Min.  
 Attenuation @ 30MHz: Transmit -27 dB Min.  
 Receive -18 dB Min.  
 Cutoff Frequency: 17 MHz Typ.

Part Number	Filter Description Transmit	Receive	Optional CMR Chokes	Schematic/ Package
FD22-101R1	100Ω Transformer + Filter	100Ω Transformer + Filter	TX/RX	A
FD12-101R2	100Ω Transformer + Filter	100Ω Transformer + Filter	TX	A
FD22-101R2	100Ω Transformer + Filter	100Ω Transformer + Filter	TX / RX	A
FD02-104R1	400Ω Transformer + Filter	100Ω Transformer + Filter	-	B
FD12-104R1	400Ω Transformer + Filter	100Ω Transformer + Filter	TX	B
FD22-104R1	400Ω Transformer + Filter	100Ω Transformer + Filter	TX / RX	B

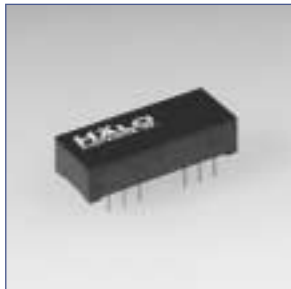

## Impedance Matching DIL 10BASE-T Filter Modules



HALO Electronics has developed this standard series of impedance matching filter modules to specifically address the 10BASE-T requirements of IEEE 802.3. Filter modules are available for most LAN IC manufacturer's products. To select the correct filter component please refer to the HALO Electronics Filter Selection Guide.

**Schematic A**

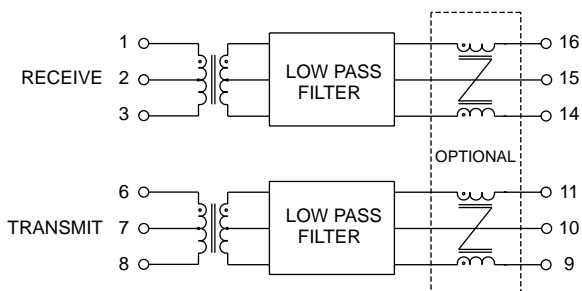

**Schematic B**

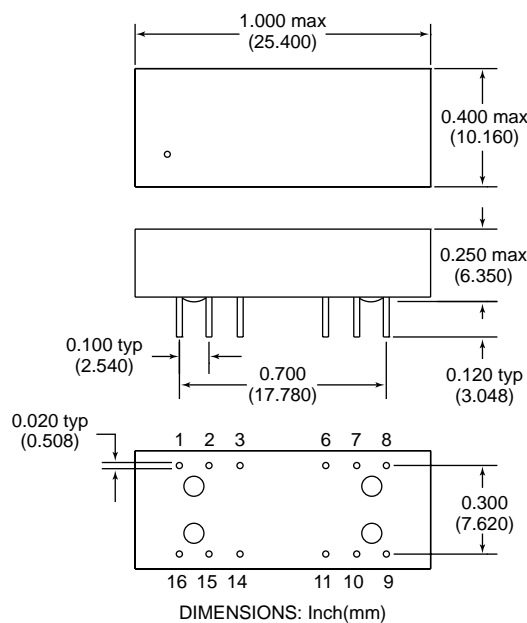
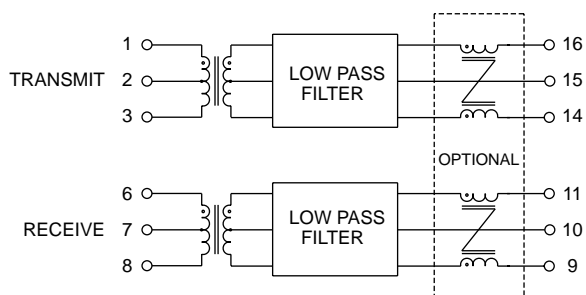

**Electrical Specifications @ 25°C**

Dielectric Withstanding Voltage: 2,000Vrms Min.  
 Insertion Loss (5-10MHz): -1 dB Max.  
 Return Loss (5-10MHz): -20 dB Min.

Cross Talk (1-10MHz): -30 dB Min.  
 Attenuation @ 30MHz: Transmit -27 dB Min.  
 Receive -18 dB Min.  
 Cutoff Frequency: 17 MHz Typ.

Part Number	Filter Description		Optional CMR Chokes	Package
	Transmit	Receive		
FD02-104G1	400Ω Transformer + Filter	100Ω Transformer + Filter	—	A
FD12-104G1	400Ω Transformer + Filter	100Ω Transformer + Filter	TX	A
FD22-104G1	400Ω Transformer + Filter	100Ω Transformer + Filter	TX / RX	A
FD02-114G	50Ω Transformer + Filter	100Ω Transformer + Filter	—	B
FD12-114G	50Ω Transformer + Filter	100Ω Transformer + Filter	TX	B
FD22-114G	50Ω Transformer + Filter	100Ω Transformer + Filter	TX / RX	B