



OTM4001A

720-channel 6-bit Source Driver with System-on-chip for Color Amorphous TFT-LCDs

Preliminary

OCT, 01, 2009

Version 0.3

Table of Contents

	<u>PAGE</u>
1. GENERAL DESCRIPTION	5
2. FEATURES	5
3. ORDERING INFORMATION	5
4. BLOCK DIAGRAM	6
5. SIGNAL DESCRIPTIONS	8
6. INSTRUCTIONS	11
6.1. OUTLINE	11
6.2. INSTRUCTION	12
6.2.1. Index Register (IR)	14
6.2.2. ID Read Register (R000h)	14
6.2.3. Driver Output Control Register (R001h)	14
6.2.4. LCD Driving Waveform Control (R002h)	14
6.2.5. Entry Mode (R003h)	15
6.2.6. Display Control 1 (R007h)	16
6.2.7. Display Control 2 (R008h)	17
6.2.8. Display Control 3 (R009h)	18
6.2.9. Low Power Control (R00Bh)	19
6.2.10. External Display Interface Control 1 (R00Ch)	19
6.2.11. External Display Interface Control 2 (R00Fh)	20
6.2.12. Panel Interface Control 1 (R010h)	20
6.2.13. Panel Interface Control 2 (R011h)	21
6.2.14. Panel Interface control 3 (R012h)	22
6.2.15. Panel Interface control 4 (R020h)	22
6.2.16. Panel Interface Control 5 (R021h)	24
6.2.17. Panel Interface Control 6 (R022h)	25
6.2.18. CABC Write Display Brightness (R051h)	25
6.2.19. CABC Read Display Brightness (R052h)	25
6.2.20. CABC Write Control Display (R053h)	26
6.2.21. CABC Read Control Display (R054h)	26
6.2.22. Write Content Adaptive Brightness Control (R055h)	27
6.2.23. Read Content Adaptive Brightness Control (R056h)	27
6.2.24. Write CABC minimum brightness (R05Eh)	27
6.2.25. Read CABC minimum brightness (R05Fh)	27
6.2.26. Frame Marker Control (R090h)	28
6.2.27. Power Control 1 (R100h)	29
6.2.28. Power Control 2 (R101h)	30
6.2.29. Power Control 3 (R102h)	31
6.2.30. Power Control 4 (R103h)	32
6.2.31. GRAM Address Set (Horizontal Address) (R200h)	33
6.2.32. GRAM Address Set (Vertical Address) (R201h)	33
6.2.33. Write Data to GRAM (R202h)	34
6.2.34. Read Data Read from GRAM (R202h)	36
6.2.35. NVM read data 2 (R281h)	37

6.2.36. NVM read data 3 (R282h)	37
6.2.37. Window Horizontal RAM Address Start (R210h)	38
6.2.38. Window Horizontal RAM Address End (R211h)	38
6.2.39. Window Vertical RAM Address Start (R212h)	38
6.2.40. Window Vertical RAM Address End (R213h)	38
6.2.41. γ Control (R300h to R30Fh)	39
6.2.42. Base Image Number of Line (R400h)	40
6.2.43. Base Image Display Control (R401h)	43
6.2.44. Based Image Vertical Scroll Control (R404h)	44
6.2.45. Display Position - Partial Display 1 (R500h)	44
6.2.46. RAM Address Start – Partial Display 1 (R501h)	44
6.2.47. RAM Address End – Partail Display 1 (R502h)	44
6.2.48. Display Position – Partial Display 2 (R503h)	44
6.2.49. RAM Address Start – Partial Display 2 (R504h)	45
6.2.50. RAM Address End – Partial Display 2 (R505h)	45
6.2.51. CABC Gamma RAM Bank Selection (R601h)	45
6.2.52. CABC Gamma RAM Bank Write (R602h)	45
6.2.53. CABC Gamma RAM Bank Read (R603h)	45
6.2.54. Pin Control (R606h)	46
7. GRAM	47
8. INTERFACES	49
8.1. SYSTEM INTERFACE	49
8.1.1. 80-system 18-bit interface	50
8.1.2. 80-system 16-bit interface	50
8.1.3. 80-system 9-bit interface	50
8.1.4. 80-system 8-bit interface	50
8.1.5. Serial Peripheral interface (SPI)	51
8.2. VSYNC INTERFACE	52
8.3. EXTERNAL DISPLAY INTERFACE	53
8.3.1. 6-bit RGB interface	54
8.3.2. 16-bit RGB interface	55
8.3.3. 18-bit RGB interface	55
9. DISPLAY FEATURE FUNCTION:	56
9.1. FMARK FUNCTION:	56
9.2. SCAN MODE FUNCTION:	57
9.3. PARTIAL DISPLAY FUNCTION:	58
9.4. GAMMA CORRECTION FUNCTIONS:	60
10. POWER MANAGEMENT SYSTEM:	61
11. APPLICATION CIRCUITS	64
12. INITIAL CODE:	65
13. ELECTRICAL CHARACTERISTICS:	66
13.1. ABSOLUTE MAXIMUM RATINGS:	66
13.2. DC CHARACTERISTICS	66
13.3. AC CHARACTERISTICS	67
13.3.1. Clock Characteristics	67

13.3.2. Clock-synchronized Serial Interface Timing Characteristics	69
13.3.3. Reset Timing Characteristics (IOVCC=1.65~3.60V)	69
13.4. POWER ON / OFF SEQUENCE DIAGRAM	73
13.5. EXTERNAL-POWER ON/OFF SEQUENCE:	74
13.6. DISPLAY ON / OFF SEQUENCE :	75
13.7. SEQUENCE TO ENTER AND EXIT SLEEP MODE :	76
13.7.1. CPU interface mode	76
13.7.2. RGB interface mode	77
13.8. PARTIAL DISPLAY MODE	78
13.9. CPU INTERFACE 8_COLOR MODE	79
13.10. CPU INTERFACE DEEP STANDBY MODE	80
14. CHIP INFORMATION	81
14.1. PAD ASSIGNMENT	81
14.2. PAD DIMENSION	81
14.2.1. Output Pads	81
14.2.2. Input Pads	81
14.3. BUMP CHARACTERISTICS	81
14.4. PAD LOCATIONS	82
14.5. ALIGNMENT MARK	91
15. COG PRODUCTS MANUFACTURING GUIDELINES	92
16. DISCLAIMER	93
17. REVISION HISTORY	94

720-CHANNEL DRIVER WITH SYSTEM-ON-CHIP (SOC) FOR COLOR AMORPHOUS TFT LCD

1. GENERAL DESCRIPTION

The OTM4001A, a 262144-color System-on-Chip (SoC) driver LSI designed for small and medium sizes of TFT LCD display, is capable of supporting up to 240xRGBx432 in resolution which can be achieved by the designated RAM for graphic data. The 720-channel source driver has true 6-bit resolution, which generates 64 Gamma-corrected values by an internal D/A converter.

The OTM4001A is able to operate with low IO interface power supply up to 1.65V and incorporate with several charge pumps to generate various voltage levels that form an on-chip power management system for gate driver and source driver.

The built-in timing controller in OTM4001A can support several interfaces for the diverse request of medium or small size portable display. OTM4001A provides system interfaces, which include 8-/9-/16-/18-bit parallel interfaces and serial interface (SPI), to configure system. Not only can the system interfaces be used to configure system, they can also access RAM at high speed for still picture display. In addition, the OTM4001A incorporates 6, 16, and 18-bit RGB interfaces for picture movement display. The OTM4001A also supports eight-color mode and standby mode for power saving consideration.

2. FEATURES

- One-chip solution for amorphous TFT-LCD.
- Supports resolution up to 240xRGBx432, incorporating a 720-channel source driver and a 432-channel gate driver
- Outputs 64 γ -corrected values using an internal true 6-bit resolution D/A converter to achieve 262K colors
- Built-in 233,280 bytes internal RAM

- Line Inversion AC drive / frame inversion AC drive
- Built-in CABC function with output control backlight pin
- System interfaces
 - High-speed interfaces to 8-, 9-, 16-, and 18-bit parallel ports
 - Serial Peripheral Interface (SPI)
- Interfaces for moving picture display
 - 6-, 16-, and 18-bit RGB interfaces
- Varies RAM accessing for functional display
 - Window address function to display at any area on the screen via a moving picture display interface
 - Window address function to limit the data rewriting area and reduce data transfer
 - Moving and still picture can display at the same time
 - Vertical scrolling function
 - Partial screen display
- Power supply
 - Logic power supply voltage (Vcc): 2.5 ~ 3.6 V
 - I/O interface supply voltage (IOVcc): 1.65 ~ 3.6 V
 - Analog power supply voltage (Vci): 2.5 ~ 3.6 V
- On-chip power management system
 - Power saving mode (standby / 8-color mode, etc)
 - Low power consumption structure for source driver.
- Built-in Charge Pump circuits
 - Source driver voltage level: DDVDH-GND=4.5V ~ 6V.
 - Gate driver voltage level (VGH, VGL)
 - VGH = 10.0V ~ 15.0V
 - VGL = -4.5V ~ -12.5V
 - VGH – VGL \leq 28.0V
 - Built-in internal oscillator and hardware reset

3. ORDERING INFORMATION

Product Number	Package Type
OTM4001A-C	Chip Form with Gold Bump

4. BLOCK DIAGRAM

4.1. Block Function

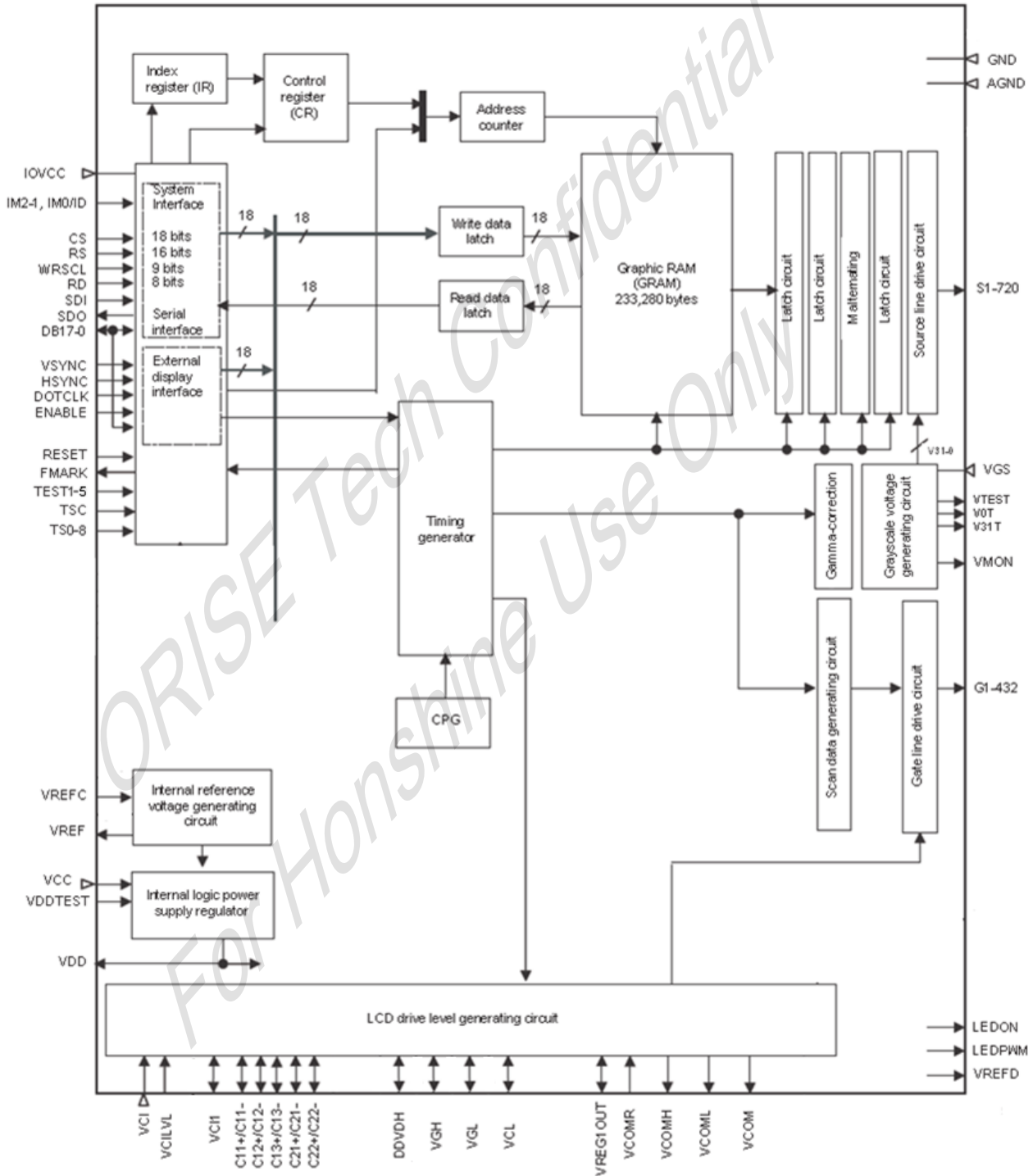

4.2. System Interface

4.2.1. The OTM4001A supports three high-speed system interfaces:

1. 80-system high-speed interfaces with 8-, 9-, 16-, 18-bit parallel ports.
2. Serial Peripheral Interface (SPI).

The OTM4001A has a 16-bit index register (IR) and two 18-bit data registers, a write-data register (WDR) and a read-data register (RDR). The IR register is used to store index information from control registers. The WDR register is used to temporarily store data to be written for register control and internal GRAM. The RDR register is used to temporarily store data read from the GRAM. When graphic data is written to the internal GRAM from MCU/graphic engine, the data is first written to the WDR and then automatically written to the internal GRAM in internal operation. When graphic data read operation is executed, graphic data is read via the RDR from the internal GRAM. Therefore, invalid data is first read out to the data bus when the OTM4001A executes the 1st read operation. Thus, valid data can be read out after the OTM4001A executes the 1st read operation.

4.2.2. External Display Interface

The OTM4001A supports external RGB interface for picture movement display.

The OTM4001A allows switching between one of the external display interfaces and the system interface via pin configuration so that the optimum interface is selected for still / moving picture displayed on the screen.

When the RGB interface is chosen, display operations are synchronized with external supplied signals, VSYNC, HSYNC, and DOTCLK. Moreover, valid display data (DB17-0) is written to GRAM, which synchronized with signal (DE) enabling.

4.2.3. Address Counter (AC)

OTM4001A features an Address Counter (AC) giving an address to the internal GRAM. The address in the AC is automatically updated plus or minus 1. The window address function enables writing data only in the rectangular area arbitrarily set by users on the GRAM.

4.2.4. Graphics RAM (GRAM)

OTM4001A features a 233,280-byte (240RGB x 432 x 18 / 8) Graphic RAM (GRAM).

4.2.5. Grayscale Voltage Generating Circuit

OTM4001A has true 6-bit resolution D/A converter, which generates 64 Gamma-corrected values and cooperates with OP-AMP structure to enhance display quality. The grayscale voltage can be adjusted by grayscale data set in the γ -correction register.

4.2.6. Timing Controller

OTM4001A has a timing controller, which can generate a timing signal for internal circuit operation such as gate output timing, RAM accessing timing, etc.

4.2.7. Oscillator (OSC)

The OTM4001A also features an internal oscillator to generate RC oscillation with an internal resistor. In standby mode, RC oscillation is halted to reduce power consumption.

4.2.8. Source Driver Circuit

OTM4001A consists of a 720-output source driver circuit (S1 ~ S720). Data in the GRAM are latched when the 720th bit data is input. The latched data controls the source driver and generates a drive waveform.

4.2.9. Gate Driver Circuit

OTM4001A consists of a 432-output gate driver circuit (G1~G432). The gate driver circuit outputs gate driver signals at either VGH or VGL level.

4.2.10. LCD Driving Power Supply Circuit

The LCD driving power supply circuit generates the voltage levels DDVDH, VLOUT2, VLOUT3 and VCOM for driving an LCD. All this voltages can be adjusted by register setting.

4.2.11. CABC Circuit

Backlight can be controlled by LEDPWM. Therefore, backlight level can be adjusted automatically depended on the display content to save power and maintain the same display quality.

5. SIGNAL DESCRIPTIONS

Signal	I/O	Connected with	Function																																																
System Configuration Input Signal																																																			
IM2~1, IM0/ID	I	GND/ IOVCC	Select a mode to interface to an MPU. In serial interface operation, the IM0 pin is used to set the ID bit of device code.																																																
			<table border="1"> <thead> <tr> <th>IM2</th> <th>IM1</th> <th>IM0/ID</th> <th>Interface Mode</th> <th>DB Pin</th> <th>Colors</th> </tr> </thead> <tbody> <tr> <td>0</td> <td>0</td> <td>0</td> <td>80-system 18-bit interface</td> <td>DB17-0</td> <td>262,144</td> </tr> <tr> <td>0</td> <td>0</td> <td>1</td> <td>80-system 9-bit interface</td> <td>DB17-9</td> <td>262,144</td> </tr> <tr> <td>0</td> <td>1</td> <td>0</td> <td>80-system 16-bit interface</td> <td>DB17-10, DB8-1</td> <td>262,144 see Note 1</td> </tr> <tr> <td>0</td> <td>1</td> <td>1</td> <td>80-system 8-bit interface</td> <td>DB17-10</td> <td>262,144 see Note 2</td> </tr> <tr> <td>1</td> <td>0</td> <td>*(ID)</td> <td>Clock synchronous serial interface</td> <td>-</td> <td>65,536</td> </tr> <tr> <td>1</td> <td>1</td> <td>0</td> <td>Setting disabled</td> <td>-</td> <td>-</td> </tr> <tr> <td>1</td> <td>1</td> <td>1</td> <td>Setting disabled</td> <td>-</td> <td>-</td> </tr> </tbody> </table>	IM2	IM1	IM0/ID	Interface Mode	DB Pin	Colors	0	0	0	80-system 18-bit interface	DB17-0	262,144	0	0	1	80-system 9-bit interface	DB17-9	262,144	0	1	0	80-system 16-bit interface	DB17-10, DB8-1	262,144 see Note 1	0	1	1	80-system 8-bit interface	DB17-10	262,144 see Note 2	1	0	*(ID)	Clock synchronous serial interface	-	65,536	1	1	0	Setting disabled	-	-	1	1	1	Setting disabled	-	-
			IM2	IM1	IM0/ID	Interface Mode	DB Pin	Colors																																											
			0	0	0	80-system 18-bit interface	DB17-0	262,144																																											
			0	0	1	80-system 9-bit interface	DB17-9	262,144																																											
			0	1	0	80-system 16-bit interface	DB17-10, DB8-1	262,144 see Note 1																																											
			0	1	1	80-system 8-bit interface	DB17-10	262,144 see Note 2																																											
			1	0	*(ID)	Clock synchronous serial interface	-	65,536																																											
			1	1	0	Setting disabled	-	-																																											
1	1	1	Setting disabled	-	-																																														
Notes: 1. 65,536 colors in one transfer mode 2. 65,536 colors in two transfers mode																																																			
/RESET	I	MPU or external RC circuit	RESET pin. This is an active low signal.																																																
Interface input Signals																																																			
/CS	I	MPU	Chip select signal. Low: the OTM4001A is accessible High: the OTM4001A is not accessible Must be connected to the GND or IOVCC level when not used.																																																
RS	I	MPU	Register select signal. Low: Index register or internal status is selected. High: Control register is selected. Must be connected to the GND or IOVCC level when not used.																																																
(/WR) / (SCL)	I	MPU	(A) In 80-system interface mode, a write strobe signal can be input via this pin and initializes a write operation when the signal is low. (B) In SPI mode, served as a synchronizing clock signal.																																																
/RD	I	MPU	In 80-system interface mode, a read strobe signal can be input via this pin and initializes a read operation when the signal is low. Must be connected to the GND or IOVCC level when not in use.																																																
SDI	I	MPU	Serial Data is inputted on the rising edge of the SCL signal in SPI mode. Must be connected to the GND or IOVCC level when not in use																																																
SDO	O	MPU	Serial Data is outputted on the rising edge of the SCL signal in SPI mode.																																																
DB0-DB17	I/O	MPU	Served as an 18-bit parallel bi-directional data bus. Data bus pin assignment corresponding to different modes are summarized in the table: <table border="1"> <thead> <tr> <th>Mode</th> <th>Pin Assignment</th> </tr> </thead> <tbody> <tr> <td>8-bit system interface</td> <td>DB17-DB10</td> </tr> <tr> <td>9-bit system interface</td> <td>DB17-DB9</td> </tr> <tr> <td>16-bit system interface</td> <td>DB17-DB10, DB8-DB1</td> </tr> <tr> <td>18-bit system interface</td> <td>DB17-DB0</td> </tr> <tr> <td>6-bit External (RGB) interface</td> <td>DB17-DB12</td> </tr> <tr> <td>16-bit External (RGB) interface</td> <td>DB17-13, DB11-DB1</td> </tr> <tr> <td>18-bit External (RGB) interface</td> <td>DB17-DB0</td> </tr> </tbody> </table> Must be connected to the GND or IOVCC level when not in use.	Mode	Pin Assignment	8-bit system interface	DB17-DB10	9-bit system interface	DB17-DB9	16-bit system interface	DB17-DB10, DB8-DB1	18-bit system interface	DB17-DB0	6-bit External (RGB) interface	DB17-DB12	16-bit External (RGB) interface	DB17-13, DB11-DB1	18-bit External (RGB) interface	DB17-DB0																																
Mode	Pin Assignment																																																		
8-bit system interface	DB17-DB10																																																		
9-bit system interface	DB17-DB9																																																		
16-bit system interface	DB17-DB10, DB8-DB1																																																		
18-bit system interface	DB17-DB0																																																		
6-bit External (RGB) interface	DB17-DB12																																																		
16-bit External (RGB) interface	DB17-13, DB11-DB1																																																		
18-bit External (RGB) interface	DB17-DB0																																																		
VSYNC	I	MPU	In external interface mode, served as a vertical synchronize signal input																																																

Signal	I/O	Connected with	Function
			Must be connected to the IOVCC or GND level when not in use.
HSYNC	I	MPU	In external interface mode, served as a horizontal synchronized signal input Must be connected to the IOVCC or GND level when not used.
ENABLE	I	MPU	In external interface mode, polarity of ENABLE signal is synchronized with valid graphic data input. Low: Valid data on DB17-DB0 High: Invalid data on DB17-DB0 Moreover, setting EPL bit can change the polarity of the ENABLE signal. Must be connected to the GND or IOVCC level when not in use.
DOTCLK	I	MPU	In external interface mode, served as a dot clock signal. When DPL = "0": Input data on the rising edge of DOTCLK When DPL = "1": Input data on the falling edge of DOTCLK It is fixed to the IOVCC level when not in use.
FMARK	O	MPU	Frame head pulse signal, which is used when writing data to the internal RAM. Keep this pin open when not used.
CABC Signal			
LEDON	O	LED	Control pin for backlight on/off
LEDPWM	O	LED	Pulse signal to control backlight level
Charge Pump and Power Supply Signal			
C11P/N, C12P/N C13P/N C21P/N, C22P/N	I/O	Step-up capacitor	Connect boost capacitors for the internal DC/DC converter circuit to these pins. Leave the pins open when DC/DC converter circuits are not used.
VCI1	I/O	Stabilizing capacitor	Reference voltage of step-up circuit 1. VC bits set the output factor. To connect to stabilizing capacitor is need. Make sure the output voltage levels from VLOUT1, VLOUT2, and VLOUT3 do not exceed the respective setting ranges.
DDVDH	I/O	Stabilizing capacitor	Output voltage from the step-up circuit 1, generated from VCI1. Power supply for the source driver liquid crystal drive unit and VCOM drive. The step-up factor is set by BT. Make sure to connect to stabilizing capacitor. . DDVDH = 4.5V ~ 6.0V
VGH	I/O	Stabilizing capacitor	Liquid crystal drive power supply. Output voltage from the step-up circuit 2, generated from VCI1 and DDVDH. The step-up factor is set by BT. Make sure to connect to stabilizing capacitor. VLOUT2 = max 15.0V
VGL	I/O	Stabilizing capacitor	Liquid crystal drive power supply. Output voltage from the step-up circuit 2, generated from VCI1 and DDVDH. The step-up factor is set by BT bits. Make sure to connect to stabilizing capacitor. VLOUT3 = min -12.5V
VCL	I/O	Stabilizing capacitor	VCOML drive power supply. Output voltage from the step-up circuit 2, generated from VCI1. The step-up factor is set by BT bits. Make sure to connect to stabilizing capacitor. VLOUT = -1.9V ~ 3.0V.
VCILVL	I	Reference power supply	VCILVL must be at the same electrical potential as VCI. VCILVL = 2.5V ~ 3.6V. Connect to external power supply. In case of COG, connect to VCI on the FPC to prevent noise.
Source/Gate Driver and VCOM Signals			
G1~G432	O	LCD	Output gate driver signals, which has the swing from VGH to VGL
S1~S720	O	LCD	Output source driver signals. The D/A converted 64-gray-scale analog voltages are outputted.
VREG1 OUT	O	Stabilizing capacitor	Output voltage generated from the reference voltage (VCILVL or VCIR). The factor is determined by instruction (VRH bits). VREG1OUT is used for (1) source driver grayscale reference voltage, (2) VCOMH level reference voltage, and (3) VCOM amplitude reference voltage. Connect to a stabilizing capacitor when in use. VREG1OUT = 4.0V ~ (DDVDH – 0.5)V
VCOM	O	TFT panel common electrode	Power supply to TFT panel's common electrode. VCOM alternates between VCOMH and VCOML. The alternating cycle is set by internal register. Also, the VCOM output can be started and halted by register setting.
VCOMH	O	Stabilizing	The High level of VCOM amplitude. The output level can be adjusted by either external

Signal	I/O	Connected with	Function
		capacitor	resistor (VCOMR) or electronic volume. Make sure to connect to stabilizing capacitor.
VCOML	O	Stabilizing capacitor	The Low level of VCOM amplitude. The output level can be adjusted by instruction (VDV bits). VCOML = (VCL+0.5)V ~ 0V. Make sure to connect to stabilizing capacitor.
VCOMR	I	Variable resistor or open	Connect a variable resistor when adjusting the VCOMH level between VREG1OUT and GND.
VGS	I	GND	Reference level for the grayscale voltage generating circuit.
VCC	-	Power supply	Internal logic power: VCC = 2.5V ~3.6V. VCC > IOVCC.
GND	-	Power supply	Internal logic GND: GND = 0V.
VDD	O	Stabilizing capacitor	Internal logic regulator output, which is used as the power supply to internal logic. Connect a stabilizing capacitor.
IOVCC	-	Power supply	Power supply to the interface pins: RESET*, CS*, WR, RD*, RS, DB17-0, VSYNC, HSYNC, DOTCLK, ENABLE. IOVCC = 1.65V ~ 3.3V. VCC ≥ IOVCC. In case of COG, connect to VCC on the FPC if IOVCC=VCC, to prevent noise.
AGND	-	Power supply	Analog GND (for logic regulator and liquid crystal power supply circuit): AGND = 0V. In case of COG, connect to GND on the FPC to prevent noise.
VCI	I	Power supply	Power supply to the liquid crystal power supply analog circuit. Connect to an external power supply of 2.5V ~ 3.6V.
Misc. Signal			
VTEST	I/O	Open	Test pins. Leave them open. OTM4001A use these pins to do self-test. No signal on panel can cross these pins, otherwise function fail.
VREFC	I/O	AGND	Test pins. Fix to the AGND level.
VREF	I/O	Open	Test pins. Leave them open.
PROTECT	I/O	Open	Test pins. Leave them open.
VDDTEST	I/O	AGND	Test pins. Fix to the AGND level.
VREFD	I/O	Open	Test pins. Leave them open. OTM4001A use these pins to do self-test. No signal on panel can cross these pins, otherwise function fail.
VMON	I/O	Open	Test pins. Leave them open. OTM4001A use these pins to do self-test. No signal on panel can cross these pins, otherwise function fail.
VCIR	I/O	Open	Test pins. Leave them open. OTM4001A use these pins to do self-test. No signal on panel can cross these pins, otherwise function fail.
TSC	I/O	GND	Test pins. Fix to the GND level.
IOVCCDUM1~2	I/O	Open	Test pins. Leave them open.
VCCDUM1	I/O	Open	Test pins. Leave them open.
AGNDDUM1~5	I/O	AGND	Test pins. Fix to the AGND level.
DUMMYR1~4	I/O	Open	Test pins. Leave them open. OTM4001A use these pins to do self-test. No any signal on panel can cross these pins, otherwise function fail.
DUMMYX	I/O	Open	Test pins. Leave them open.
DUMMYY	I/O	Open	Test pins. Leave them open.
DUMMYZ	I/O	Open	Test pins. Leave them open.
DUMMYA	I/O	Open	Test pins. Leave them open.
DUMMYC	I/O	Open	Test pins. Leave them open.
GNDDUM1~10	I/O	Open	Test pins. Leave them open.
VGLDMY1~4	I/O	Open	Test pins. Leave them open.
TESTO1~15	I/O	Open	Test pins. Leave them open.
TS0~8	I	Open	Test pins. Leave them open.
TEST1~5	I	GND	Test pins. Connect to GND level.

6. INSTRUCTIONS

6.1. Outline

The OTM4001A supports 18-bit data bus interface to access command register to configure system. When the command register accessing is desired, sending the command information to specify which index register would be accessed and following the data to that control register. Moreover, register accessing operation should cooperate with RS, /WR, /RD signal for OTM4001A to recognize the control instruction. And command instruction can be accomplished by using all system interfaces (18-bit, 16-bit, 9-bit, 8-bit 80 system and SPI). The corresponding pin assignment of different system interface are shown in **Figure 6-1** to **Figure 6-6**

The instruction can be categorized into 8 groups. And the 8 groups are:

1. Specify the index of register
2. Read a status
3. Display control
4. Power management Control
5. Graphics data processing
6. Set internal GRAM address
7. Transfer data to and from the internal GRAM
8. Internal grayscale γ -correction

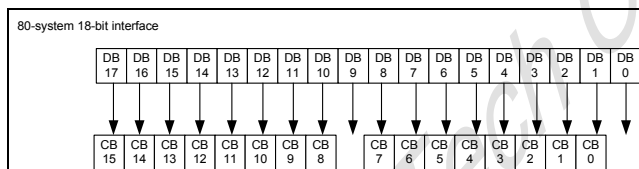

Figure 6-1

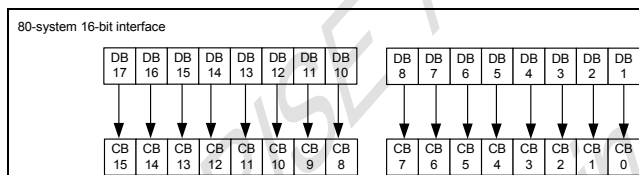

Figure 6-2

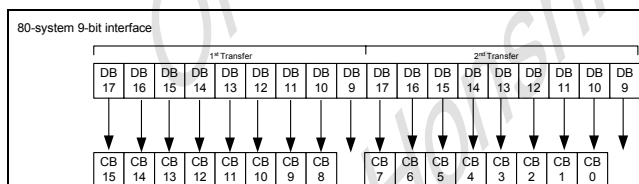

Figure 6-3

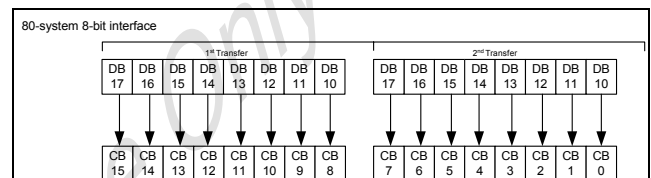

Figure 6-4

Serial interface Data Format

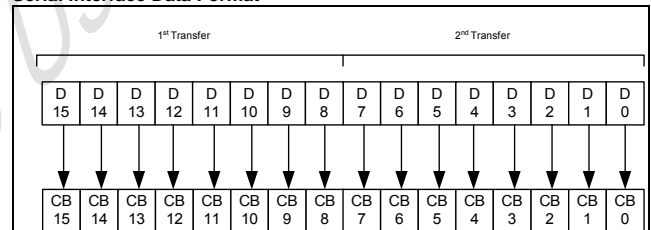

Figure 6-5

Serial interface Data Transfer Format

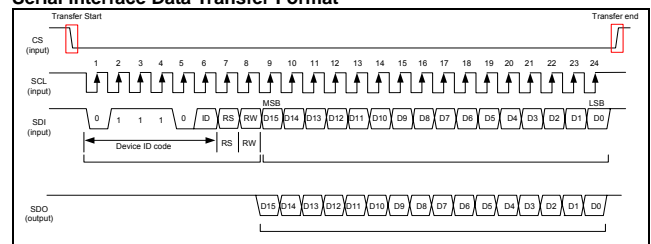

Figure 6-6

6.2. Instruction
Table 6-1 Instruction List Table

Register No	Register	Upper 8-bit								Lower 8-bit									
		CB15	CB14	CB13	CB12	CB11	CB10	CB9	CB8	CB7	CB6	CB5	CB4	CB3	CB2	CB1	CB0		
000h	ID Read	0	1	0	1	0	1	0	0	0	0	1	0	0	0	0			
001h	Driver Output Control	0	0	0	0	0	SM (0)	0	SS (0)	0	0	0	0	0	0	0			
002h	LCD Drive Waveform Control	0	0	0	0	0	0	0	B/C (0)	0	0	0	0	0	0	0			
003h	Entry Mode	TRIREG (0)	DFM (0)	0	BGR (0)	0	0	0	0	ORG (0)	0	I/D1 (1)	I/D0 (1)	AM (0)	0	EPF1 (0) EPF0 (0)			
004h-006h	Setting disabled																		
007h	Display Control (1)	0	0	PTDE1 (0)	PTDE0 (0)	0	0	0	BASEE (0)	0	0	GON (0)	DTE (0)	0	0	D1 (0) D0 (0)			
008h	Display Control (2)	0	0	0	0	FP3 (1)	FP2 (0)	FP1 (0)	FP0 (0)	0	0	0	0	BP3 (1)	BP2 (0)	BP1 (0) BP0 (0)			
009h	Low Power Control (1)	0	0	0	0	PTV (0)	PTS2 (0)	PTS1 (0)	PTS0 (0)	0	0	PTG1 (0)	PTG0 (0)	ISC3 (0)	ISC2 (0)	ISC1 (0) ISC0 (0)			
00Ah	Setting Disabled																		
00Bh	Low Power Control (2)	0	0	0	0	0	0	0	0	0	0	0	VEMO (0)	0	0	0	COL (0)		
00Ch	External Display Control (1)	0	0	0	0	0	0	0	RM (0)	0	0	DM1 (0)	DM0 (0)	0	0	RIM1 (0) RIM0 (0)			
00Dh-00Eh	Setting Disabled																		
00Fh	External Display Control (2)	0	0	0	0	0	0	0	0	0	0	0	V SPL (0)	HSPL (0)	0	EPL (0) DPL (0)			
010h	Panel interface Control 1	0	0	0	0	0	0	DIV11 (0)	DIV10 (0)	0	0	0	RTN4 (1)	RTN3 (0)	RTN2 (1)	RTN1 (1) RTN0 (1)			
011h	Panel interface Control 2	0	0	0	0	0	0	NOW12 (0)	NOW11 (0)	NOW10 (0)	0	0	0	0	SDT12 (0)	SDT11 (0) SDT10 (0)			
012h	Panel interface Control 3	0	0	0	0	0	0	VEQW11 (0)	VEQW10 (0)	0	0	0	0	0	0	0			
013-01Fh	Setting Disabled																		
020h	Panel Interface Control 4	0	0	0	0	0	0	DIVE1 (0)	DIVE0 (0)	0	0	RTNE6 (0)	RTNE5 (0)	RTNE4 (1)	RTNE3 (1)	RTNE2 (1) RTNE1 (1) RTNE0 (0)			
021h	Panel Interface Control 5	0	0	0	0	NOWE3 (0)	NOWE2 (0)	NOWE1 (0)	NOWE0 (0)	0	0	0	0	SDTE3 (0)	SDTE2 (0)	SDTE1 (0) SDTE0 (0)			
022h	Panel Interface Control 6	0	0	0	0	0	0	VEQWE2 (0)	VEQWE1 (0)	VEQWE0 (0)	0	0	0	0	0	0			
023h-050h	Setting Disabled																		
051h	WRDISBV	0	0	0	0	0	0	0	0	0	0	DBV7 (0)	DBV6 (0)	DBV5 (0)	DBV4 (0)	DBV3 (0) DBV2 (0) DBV1 (0) DBV0 (0)			
052h	RDDISBV	0	0	0	0	0	0	0	0	0	0	DBV7	DBV6	DBV5	DBV4	DBV3	DBV2	DBV1	DBV0
053h	WRCTRLD	0	0	0	0	0	0	0	0	BC_OUT_INV (0)	LED_ON (0)	BCTRL (0)	0	DD (0)	BL (0)	0	0		
054h	RDCTRLD	0	0	0	0	0	0	0	0	BC_OUT_INV (0)	LED_ON (0)	BCTRL (0)	0	DD (0)	BL (0)	0	0		
055h	WRCABC	0	0	0	0	0	0	0	0	0	0	0	0	0	0	C1 (0) C0 (0)			
056h	RDCABC	0	0	0	0	0	0	0	0	0	0	0	0	0	0	C1	C0		
05Eh	WRCABCMB	0	0	0	0	0	0	0	0	CMB7 (0)	CMB6 (0)	CMB5 (0)	CMB4 (0)	CMB3 (0)	CMB2 (0)	CMB1 (0) CMB0 (0)			
05Fh	RDCABCMB	0	0	0	0	0	0	0	0	CMB7	CMB6	CMB5	CMB4	CMB3	CMB2	CMB1	CMB0		
090h	Frame Marker Control	FMKM (0)	FMI2 (0)	FMI1 (0)	FMI0 (0)	0	0	0	FMP8 (0)	FMP7 (0)	FMP6 (0)	FMP5 (0)	FMP4 (0)	FMP3 (0)	FMP2 (0)	FMP1 (0) FMP0 (0)			
091h-0FFh	Setting disabled																		
100h	Power Control (1)	0	0	0	SAP (0)	0	BT2 (0)	BT1 (0)	BT0 (0)	APE (0)	0	AP1 (0)	AP0 (0)	0	DSTB (0)	SLP (0)	0		
101h	Power Control (2)	0	0	0	0	0	DC12 (0)	DC11 (0)	DC10 (0)	0	DC02 (0)	DC01 (0)	DC00 (0)	0	VC2 (0)	VC1 (0)	VC0 (0)		
102h	Power Control (3)	0	0	0	0	0	0	0	VCMR0 (0)	VREG1R (0)	0	0	0	VRH3 (0)	VRH2 (0)	VRH1 (0) VRH0 (0)			
103h	Power Control (4)	0	0	0	VDV4 (0)	VDV3 (0)	VDV2 (0)	VDV1 (0)	VDV0 (0)	0	0	0	0	0	0	0			
104h-106h	Setting disabled																		
107h	Power Control (5)	0	0	0	0	0	0	0	0	0	0	0	0	0	0	0			
108-10Fh	Setting disabled																		
110h	Power Control(6)	0	0	0	0	0	0	0	0	0	0	0	0	0	0	0			
111-1ffh	Setting disabled																		
200h	GRAM address Set Horizontal Address	0	0	0	0	0	0	0	0	AD7 (0)	AD6 (0)	AD5 (0)	AD4 (0)	AD3 (0)	AD2 (0)	AD1 (0) AD0 (0)			
201h	GRAM address Set Vertical Address	0	0	0	0	0	0	0	0	AD16 (0)	AD15 (0)	AD14 (0)	AD13 (0)	AD12 (0)	AD11 (0)	AD10 (0) AD9 (0) AD8 (0)			
202h	Write Data to GRAM Read Data from GRAM	Data format is varied according to "interface".																	
203-20Fh	Setting disabled																		
210h	Window Horizontal RAM Address Start	0	0	0	0	0	0	0	0	HSA7 (0)	HSA6 (0)	HSA5 (0)	HSA4 (0)	HSA3 (0)	HSA2 (0)	HSA1 (0) HSA0 (0)			

211h	Window Horizontal RAM Address End	0	0	0	0	0	0	0	0	HEA7 (1)	HEA6 (1)	HEA5 (1)	HEA4 (0)	HEA3 (1)	HEA2 (1)	HEA1 (1)	HEA0 (1)
212h	Window Vertical RAM Address Start	0	0	0	0	0	0	0	VSA8 (0)	VSA7 (0)	VSA6 (0)	VSA5 (0)	VSA4 (0)	VSA3 (0)	VSA2 (0)	VSA1 (0)	VSA0 (0)
213h	Window Vertical RAM Address End	0	0	0	0	0	0	0	VEA8 (1)	VEA7 (0)	VEA6 (0)	VEA5 (1)	VEA4 (1)	VEA3 (1)	VEA2 (1)	VEA1 (1)	VEA0 (1)
214-280h	Setting Disabled																
281h	VCom high voltage 1	0	0	0	0	0	0	0	0	0	0	VCM14 (0)	VCM13 (0)	VCM12 (0)	VCM11 (0)	VCM10 (0)	
282h	VCom high voltage 2	0	0	0	0	0	0	0	VCMSEL (0)	0	0	VCM24 (0)	VCM23 (0)	VCM22 (0)	VCM21 (0)	VCM20 (0)	
283-2FFh	Setting disabled																
300h	γ Control (1)	0	0	0	V1RP4	V1RP3	V1RP2	V1RP1	V1RP0	0	0	0	V6RN4	V6RN3	V6RN2	V6RN1	V6RN0
301h	γ Control (2)	0	0	V2RP5	V2RP4	V2RP3	V2RP2	V2RP1	V2RP0	0	0	V5RN5	V5RN4	V5RN3	V5RN2	V5RN1	V5RN0
302h	γ Control (3)	0	0	V3RP5	V3RP4	V3RP3	V3RP2	V3RP1	V3RP0	0	0	V4RN5	V4RN4	V4RN3	V4RN2	V4RN1	V4RN0
303h	γ Control (4)	0	0	V4RP5	V4RP4	V4RP3	V4RP2	V4RP1	V4RP0	0	0	V3RN5	V3RN4	V3RN3	V3RN2	V3RN1	V3RN0
304h	γ Control (5)	0	0	V5RP5	V5RP4	V5RP3	V5RP2	V5RP1	V5RP0	0	0	V2RN5	V2RN4	V2RN3	V2RN2	V2RN1	V2RN0
305h	γ Control (6)	0	0	0	V6RP4	V6RP3	V6RP2	V6RP1	V6RP0	0	0	0	V1RN4	V1RN3	V1RN2	V1RN1	V1RN0
306h	γ Control (7)	0	0	0	V7RP4	V7RP3	V7RP2	V7RP1	V7RP0	0	0	0	V8RN4	V8RN3	V8RN2	V8RN1	V8RN0
307h	γ Control (8)	0	0	0	V8RP4	V8RP3	V8RP2	V8RP1	V8RP0	0	0	0	V7RN4	V7RN3	V7RN2	V7RN1	V7RN0
308h	γ Control (9)	0	0	0	0	V9RP3	V9RP2	V9RP1	V9RP0	0	0	0	0	V16RN3	V16RN2	V16RN1	V16RN0
309h	γ Control (10)	0	0	0	0	V10RP3	V10RP2	V10RP1	V10RP0	0	0	0	0	V15RN3	V15RN2	V15RN1	V15RN0
30Ah	γ Control (11)	0	0	0	0	V11RP3	V11RP2	V11RP1	V11RP0	0	0	0	0	V14RN3	V14RN2	V14RN1	V14RN0
30Bh	γ Control (12)	0	0	0	0	V12RP3	V12RP2	V12RP1	V12RP0	0	0	0	0	V13RN3	V13RN2	V13RN1	V13RN0
30Ch	γ Control (13)	0	0	0	0	V13RP3	V13RP2	V13RP1	V13RP0	0	0	0	0	V12RN3	V12RN2	V12RN1	V12RN0
30Dh	γ Control (14)	0	0	0	0	V14RP3	V14RP2	V14RP1	V14RP0	0	0	0	0	V11RN3	V11RN2	V11RN1	V11RN0
30Eh	γ Control (15)	0	0	0	0	V15RP3	V15RP2	V15RP1	V15RP0	0	0	0	0	V10RN3	V10RN2	V10RN1	V10RN0
30Fh	γ Control (16)	0	0	0	0	V16RP3	V16RP2	V16RP1	V16RP0	0	0	0	0	V9RN3	V9RN2	V9RN1	V9RN0
310-3FFh	Setting disabled																
400h	Size of base image	GS (0)	0	NL5 (0)	NL4 (0)	NL3 (0)	NL2 (0)	NL1 (0)	NL0 (0)	0	0	SCN5 (0)	SCN4 (0)	SCN3 (0)	SCN2 (0)	SCN1 (0)	SCN0 (0)
401h	Base image display control	0	0	0	0	0	0	0	0	0	0	0	0	0	NDL (0)	VLE (0)	REV (0)
402-403h	Setting disabled																
404h	Vertical Scroll Control	0	0	0	0	0	0	0	VL8 (0)	VL7 (0)	VL6 (0)	VL5 (0)	VL4 (0)	VL3 (0)	VL2 (0)	VL1 (0)	VL0 (0)
405-4FFh	Setting disabled																
500h	Display Position - Partial Display 1	0	0	0	0	0	0	0	PTDP08 (0)	PTDP07 (0)	PTDP06 (0)	PTDP05 (0)	PTDP04 (0)	PTDP03 (0)	PTDP02 (0)	PTDP01 (0)	PTDP00 (0)
501h	RAM Address Start - Partial Display 1	0	0	0	0	0	0	0	PTSA08 (0)	PTSA07 (0)	PTSA06 (0)	PTSA05 (0)	PTSA04 (0)	PTSA03 (0)	PTSA02 (0)	PTSA01 (0)	PTSA00 (0)
502h	RAM Address End - Partial Display 1	0	0	0	0	0	0	0	PTEA08 (0)	PTEA07 (0)	PTEA06 (0)	PTEA05 (0)	PTEA04 (0)	PTEA03 (0)	PTEA02 (0)	PTEA01 (0)	PTEA00 (0)
503h	Display Position - Partial Display 2	0	0	0	0	0	0	0	PTDP18 (0)	PTDP17 (0)	PTDP16 (0)	PTDP15 (0)	PTDP14 (0)	PTDP13 (0)	PTDP12 (0)	PTDP11 (0)	PTDP10 (0)
504h	RAM Address Start - Partial Display 2	0	0	0	0	0	0	0	PTSA18 (0)	PTSA17 (0)	PTSA16 (0)	PTSA15 (0)	PTSA14 (0)	PTSA13 (0)	PTSA12 (0)	PTSA11 (0)	PTSA10 (0)
505h	RAM Address End - Partial Display 2	0	0	0	0	0	0	0	PTEA18 (0)	PTEA17 (0)	PTEA16 (0)	PTEA15 (0)	PTEA14 (0)	PTEA13 (0)	PTEA12 (0)	PTEA11 (0)	PTEA10 (0)
506-5FF	Setting Disabled																
600h	Software reset	0	0	0	0	0	0	0	0	0	0	0	0	0	0	0	SRFT
601h	CABC RAM Bank Sel	0	0	0	0	0	0	0	0	0	0	0	0	0	Bank2	Bank1	Bank0
602h	CABC RAM Write	0	0	0	0	0	0	0	0	0	0	0	0	0	0	0	0
603h	CABC RAM Read	0	0	0	0	0	0	0	0	0	0	0	0	0	0	0	0
606h	i80-I/F Endian Control	0	0	0	0	0	0	0	TCREV1 (0)	0	0	0	0	0	0	0	TCREV0 (0)
607-FFFh	Setting disabled																

The following are detailed explanations of instructions with illustrations of instruction bits (CB15-0) assigned to each interface.

6.2.1. Index Register (IR)

R/W	RS	CB15	CB14	CB13	CB12	CB11	CB10	CB9	CB8	CB7	CB6	CB5	CB4	CB3	CB2	CB1	CB0
W	0	0	0	0	0	0	ID10	ID9	ID8	ID7	ID6	ID5	ID4	ID3	ID2	ID1	ID0

The index register specifies the index (R000h ~ RFFFh) of a control register.

6.2.2. ID Read Register (R000h)

R/W	RS	CB15	CB14	CB13	CB12	CB11	CB10	CB9	CB8	CB7	CB6	CB5	CB4	CB3	CB2	CB1	CB0
R	0	0	1	0	1	0	1	0	0	0	0	1	0	0	0	0	0

The IC code of OTM4001A can be accessed by read operation. '5420H' can be read out when read ID operation is executed.

6.2.3. Driver Output Control Register (R001h)

R/W	RS	CB15	CB14	CB13	CB12	CB11	CB10	CB9	CB8	CB7	CB6	CB5	CB4	CB3	CB2	CB1	CB0
W	1	0	0	0	0	0	SM(0)	0	SS(0)	0	0	0	0	0	0	0	0

SS: Shift direction of the source driver output selection.

When SS = "0", source driver shifts from S1 to S720. When SS = "1", source driver shifts from S720 to S1. Moreover, SS can cooperate with BGR for different color filter configuration of LCD panel. The combination of SS and BGR bit are summarized at **Table 6-2**.

Table 6-2

SS=0;BGR=0;	S1	S2	S3	→	S718	S719	S720
SS=0;BGR=1;	S1	S2	S3	→	S718	S719	S720
SS=1;BGR=0;	S1	S2	S3	←	S718	S719	S720
SS=1;BGR=1;	S1	S2	S3	←	S718	S719	S720

SM: Set the scan mode of the gate driver output. Moreover, SM can cooperate with GS for different LCD panel gate line layout. The combination of GS and SM bit are summarized at **Table 6-3**.

Table 6-3

SM	GS	Shift Direction (begin,.....,end)
0	0	G1, G2, G3, G4.....G429, G430, G431, G432
0	1	G432, G431, G430, G429.....G4, G3, G2, G1

6.2.4. LCD Driving Waveform Control (R002h)

R/W	RS	CB15	CB14	CB13	CB12	CB11	CB10	CB9	CB8	CB7	CB6	CB5	CB4	CB3	CB2	CB1	CB0
W	1	0	0	0	0	0	0	0	B/C(0)	0	0	0	0	0	0	0	0

B/C: This bit is to set the Vcom toggle at frame rate format of N-line inversion format.

B/C=0: Frame inversion.

B/C=1: 1-line inversion.

6.2.5. Entry Mode (R003h)

R/W	RS	CB15	CB14	CB13	CB12	CB11	CB10	CB9	CB8	CB7	CB6	CB5	CB4	CB3	CB2	CB1	CB0
W	1	TRI REG(0)	DFM (0)	0	BGR (0)	0	0	0	0	ORG (0)	0	I/D1 (1)	I/D0 (1)	AM (0)	0	EPF1 (0)	EPF0 (0)

Table 6-4

Operation mode	ORG	AM	I/D1	I/D0	Function
Mode 1	0	0	0	0	Replace horizontal data
Mode2	0	1	0	1	Replace vertical data
Mode3	1	0	1	0	Conditionally replace horizontal data
Mode4	1	1	1	1	Conditionally replace vertical data

AM: To set the update direction when writing data to GRAM. If AM=1, data will write in vertical direction. If AM=0, data will write in horizontal direction. Moreover, if a fixed window GRAM accessing is desired, the writing direction can be set by I/D1-0 and AM bits.

I/D1-0: To specify address counter increment / decrement automatically function while GRAM is accessing. I/D[0] indicates the increment or decrement in horizontal direction. I/D[1] indicates the increment or decrement in vertical direction.

I/D[0]=0: decrement in horizontal direction automatically

I/D[0]=1: increment in horizontal direction automatically

I/D[1]=0: decrement in vertical direction automatically

I/D[1]=1: increment in vertical direction automatically

I/D[1-0] setting can cooperate with AM bit to set the data updating direction.

ORG: OTM4001A provides the option of start address definition

when window function is selected.

ORG=1: RAM address setting should set to (00000h) no matter where the window start address is. In this case, the window start position is treated as (00000h), regardless the physical location in GRAM.

ORG=0: RAM address setting should set to the address.

BGR: To set the order of RGB dot location in GRAM.

BGR=0: same assignment of RGB allocation of DB17-0

BGR=1: inverse assignment of RGB allocation of DB17-0

DFM: In combination with TRIREG setting to set the different data transfer mode.

TRIREG: to set 1-3 time transfer mode for system interface.

TRIREG bit should cooperate with DFM to meet the specific transfer mode.

For 8-bit databus interface mode:

TRIREG=0: 2 time transfer mode for 16-bit GRAM data.

TRIREG=1: 3 time transfer mode for 18-bit GRAM data

For 16-bit databus interface mode:

TRIREG=0: 1 time transfer mode for 16-bit GRAM data.

TRIREG=1: 2 time transfer mode for 18-bit GRAM data

Note: Set TRIREG=0, when using neither 8-bit nor 16-bit.

EPF1-0: To select the algorithm of expanding 8/16 bits to 18 bits.

This setting is valid only when 16-bit or 8-bit interfaces are in use.

6.2.6. Display Control 1 (R007h)

R/W	RS	CB15	CB14	CB13	CB12	CB11	CB10	CB9	CB8	CB7	CB6	CB5	CB4	CB3	CB2	CB1	CB0
W	1	0	0	PTDE1 (0)	PTDE0 (0)	0	0	0	BASEE (0)	0	0	GON (0)	DTE (0)	0	0	D1 (0)	D0 (0)

D1-0: To set the internal operation, source driver output and VCOM output function. When D1-0=00; OTM4001A is set to standby mode. The combination of D1-0 and BASEE bit is summarized at **Table 6-5**.

Table 6-5

D1	D0	BASEE	Source, VCOM output	Internal Operation	FLM
0	0	*	GND	Terminated	OFF
0	1	*	GND	Normal Operation	ON
1	0	*	Non-lit display	Normal Operation	ON
1	1	0	Non-lit display	Normal Operation	ON
		1	Normal display	Normal Operation	ON

DTE, GON: Specify the high/low level of gate driver output signal. The combination of DTE and GON bit is summarized at **Table 6-6**.

Table 6-6

APE	GON	DTE	Gate Output
0	*	*	VGL(=GND)
1	0	0	VGH
	0	1	VGH
	1	0	VGL
	1	1	VGH/VGL

Table 6-7

APE	AP [2:0]	VCOMG	VCOM Output
0	*	*	GND
1	000	0	GND
	000	0-1	Setting Disabled
	000	1	Setting Disabled
	001-111	0	GND
	001-111	1	VCOML
	001-111	0	VCOMH/GND
	001-111	1	VCOMH/VCOML

BASEE: To enable Base image display

BASEE	
0	(1) Non-lit display (2) Partial image display
1	Base image is display on the LCD

PTDE1-0: To set the partial-display enables function.

PTDE [0]: "0" Partial image 1 display "Off".

"1" Partial image 1 display "On".

PTDE [1]: "0" Partial image 2 display "Off".

"1" Partial image 2 display "On".

6.2.7. Display Control 2 (R008h)

R/W	RS	CB15	CB14	CB13	CB12	CB11	CB10	CB9	CB8	CB7	CB6	CB5	CB4	CB3	CB2	CB1	CB0
W	1	0	0	0	0	FP3 (1)	FP2 (0)	FP1 (0)	FP0 (0)	0	0	0	0	BP3 (1)	BP2 (0)	BP1 (0)	BP0 (0)

FP3-0: Set the amount of blank period of front porch

BP3-0: Set the amount of blank period of back porch

Table 6-8 summarized the function of FP3-0/BP3-0 setting.

When setting this register, make sure that:

BP + FP ≤ 16 lines

FP ≥ 2 lines

BP ≥ 2 lines

In external display interface mode, a back porch (BP) period starts on the falling edge of the VSYNC signal, followed by a display operation period. After driving the number of lines set with NL bits, a front porch period starts. After the front porch period, a blank period continues until the next input of VSYNC signal. Be aware that different interface mode, has different BP/ FP setting. **Table 6-9** summarized the setting for each interface mode.

Table 6-8

FP3	FP2	FP1	FP0	Number of lines for the Front Porch
BP3	BP2	BP1	BP0	Number of lines for the Back Porch
0	0	0	0	Setting disabled
0	0	0	1	Setting disabled
0	0	1	0	2 lines
0	0	1	1	3 lines
0	1	0	0	4 lines
0	1	0	1	5 lines
0	1	1	0	6 lines
0	1	1	1	7 lines
1	0	0	0	8 lines
1	0	0	1	9 lines
1	0	1	0	10 lines
1	0	1	1	11 lines
1	1	0	0	12 lines
1	1	0	1	13 lines
1	1	1	0	14 lines
1	1	1	1	Setting disabled

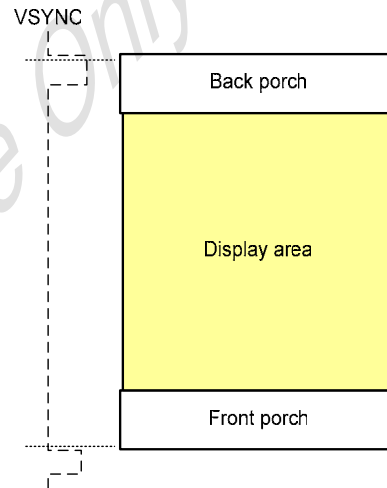

Figure 6-7 Front porch and back porch function diagram

Table 6-9

Operation of Internal clock	BP ≥ 2 lines	FP ≥ 2 lines	FP + BP ≤ 16 lines
RGB interface	BP ≥ 2 lines	FP ≥ 2 lines	FP + BP ≤ 16 lines
VSYNC interface	BP ≥ 2 lines	FP ≥ 2 lines	FP + BP = 16 lines

6.2.8. Display Control 3 (R009h)

R/W	RS	CB15	CB14	CB13	CB12	CB11	CB10	CB9	CB8	CB7	CB6	CB5	CB4	CB3	CB2	CB1	CB0
W	1	0	0	0	0	PTV (0)	PTS2 (0)	PTS1 (0)	PTS0 (0)	0	0	PTG1 (0)	PTG0 (0)	ISC3 (0)	ISC2 (0)	ISC1 (0)	ISC0 (0)

ISC3-0: To set the gate driver scan cycle in non-display area. **Table 6-10** summarized the function of ISC3-0 setting

Table 6-10

ISC3	ISC2	ISC1	ISC0	Scan cycle	fFLM=60Hz
0	0	0	0	Setting disable	
0	0	0	1	3frames	50 ms
0	0	1	0	5 frames	84 ms
0	0	1	1	7 frames	117 ms
0	1	0	0	9 frames	150 ms
0	1	0	1	11 frames	184 ms
0	1	1	0	13 frames	217 ms
0	1	1	1	15 frames	251 ms
1000-1111				Setting Disabled	

PTG1-0: To set the gate driver scan mode in non-display area. **Table 6-11** summarized the function of PTG1-0 setting

Table 6-11

PTG1	PTG0	Gate outputs in non-display area	Source outputs in non-display area	VCOM output
0	0	Normal scan	Based on the PTS2-0 bits setting	VCOMH/VCOML
0	1	Setting Disable		
1	0	Interval scan	Based on the PTS2-0 bits setting	VCOMH/VCOML
1	1	Setting Disable		

PTS2-0: To set the source driver output level in non-display area of partial display mode. **Table 6-12** summarized the function of PTS2-0 setting.

Table 6-12

PTS2	PTS1	PTS0	Source output in non-display area		Operation amplifier in non-display area
			+ve polarity	-ve polarity	
0	0	0	V31	V0	V0-V31
001-011			Setting inhibited		
1	0	0	V31	V0	V0-V31
101-111			Setting inhibited		

PTV: To set VCOM output in non-display area, Vcom operates normally when PTV = 1, and stops operation when PTV = 0.

6.2.9. Low Power Control (R00Bh)

R/W	RS	CB15	CB14	CB13	CB12	CB11	CB10	CB9	CB8	CB7	CB6	CB5	CB4	CB3	CB2	CB1	CB0
W	1	0	0	0	0	0	0	0	0	0	0	0	VEM0 (0)	0	0	0	COL (0)

COL:

COL = 0: 262,144 colors

COL = 1: 8 colors.

In 8-color mode, the source output is either connected to VREGIOUT or GND.

VEM0: VEM0 = 1, when VCOM is switched from VCOMH to VCOML, it will dropped to GND level in the intermediate stage.

VEM0 = 0, when VCOM is switched from VCOMH to VCOML, it will directly change to VCOML level.

6.2.10. External Display Interface Control 1 (R00Ch)

R/W	RS	CB15	CB14	CB13	CB12	CB11	CB10	CB9	CB8	CB7	CB6	CB5	CB4	CB3	CB2	CB1	CB0
W	1	0	0	0	0	0	0	0	RM (0)	0	0	DM1 (0)	DM0 (0)	0	0	RIM1 (0)	RIM0 (0)

RIM1-0: To set the different transfer modes of RGB interface.

Table 6-13 summarized the function of RIM1-0 setting.

Table 6-13

RIM1	RIM0	RGB Interface Mode	Colors	Data Bus
0	0	18-bit RGB interface (one transfer/pixel)	262K	DB 17-0
0	1	16-bit RGB interface (one transfer/pixel)	65K	DB 17-13; DB 11-1
1	0	6-bit RGB interface (three transfers/pixel)	262K	DB17-12
1	1	Setting disabled	-	-

DM1-0: To specify the display interface mode.

Table 6-14 summarized the function of DM1-0 setting.

Table 6-14

DM1	DM0	Display Interface
0	0	Internal clock operation
0	1	RGB interface
1	0	VSYNC interface
1	1	Setting disabled

RM: Select the interface to access the OTM4001A's internal GRAM. The setting of RM should be consistent with DM1-0.

Table 6-15 summarized the function of RM bit setting.

Table 6-15

RM	Interface for RAM Access
0	System interface/VSYNC interface
1	RGB interface

6.2.11. External Display Interface Control 2 (R00Fh)

R/W	RS	CB15	CB14	CB13	CB12	CB11	CB10	CB9	CB8	CB7	CB6	CB5	CB4	CB3	CB2	CB1	CB0
W	1	0	0	0	0	0	0	0	0	0	0	0	VSPL (0)	HSPL (0)	0	EPL (0)	DPL (0)

DPL: Select the data latch edge of the DOTCLK signal in RGB interface mode.

DPL = "0": rising edge of the DOTCLK.

DPL = "1": falling edge of the DOTCLK.

HSPL: The polarity of HSYNC signal selection in RGB interface mode.

HSPL = "0": Low active.

HSPL = "1": High active.

EPL: The polarity of ENABLE signal selection in RGB interface mode.

EPL = "0": ENABLE: Low active

EPL = "1": ENABLE: High active

VSPL: The polarity of VSYNC signal selection in RGB interface mode.

VSPL = "0": Low active.

VSPL = "1": High active.

6.2.12. Panel Interface Control 1 (R010h)

R/W	RS	CB15	CB14	CB13	CB12	CB11	CB10	CB9	CB8	CB7	CB6	CB5	CB4	CB3	CB2	CB1	CB0
W	1	0	0	0	0	0	0	DIV11 (0)	DIV10 (0)	0	0	0	RTNI4 (1)	RTNI3 (0)	RTNI2 (1)	RTNI1 (1)	RTNI0 (1)

RTNI4-0: Set the clock cycle per line **Table 6-16** summarized the function of RTNI4-0 setting.

Table 6-16

RTNI4	RTNI3	RTNI2	RTNI1	RTNI0	Clock Cycles per line
0	0	0	0	0	Setting disable
Setting disable					
1	0	0	0	0	16 clocks
1	0	0	0	1	17 clocks
1	0	0	1	0	18 clocks
1	0	0	1	1	19 clocks
1	0	1	0	0	20 clocks
1	0	1	0	1	21 clocks
1	0	1	1	0	22 clocks
1	0	1	1	1	23 clocks
1	1	0	0	0	24 clocks
1	1	0	0	1	25 clocks
1	1	0	1	0	26 clocks
1	1	0	1	1	27 clocks
1	1	1	0	0	28 clocks
1	1	1	0	1	29 clocks
1	1	1	1	0	30 clocks
1	1	1	1	1	31 clocks

DIV11-0: To specified the division ratio of internal operation clock frequency. Set the RTN and DIV1 bits to adjust frame frequency. Be aware of that if the number of lines for driving liquid crystal is changed, the frame frequency must also be adjusted. Moreover, In RGB interface mode, the DIV11-0 bits are disabled. **Table 6-17** summarized the function of DIV11-0 setting.

Table 6-17

DIV11	DIV10	Division Ratio	Internal Operation Clock Frequency
0	0	1	fosc / 1
0	1	2	fosc / 2
1	0	4	fosc / 4
1	1	8	fosc / 8

fosc =Frequency of RC oscillation

Formula to calculate frame frequency

$$\text{Frame frequency} = \frac{fosc}{\text{Clock cycles per line} \times \text{division ratio} \times (\text{Line} + \text{BP} + \text{FP})} \quad [\text{Hz}]$$

fosc: frequency of RC oscillation

Line: number of lines for driving liquid crystal (NL bits)

Division ratio: DIV1 bits

Clock cycles per line: RTNI bits

FP: the number of lines for the front porch period

BP: the number of lines for the back porch period

6.2.13. Panel Interface Control 2 (R011h)

R/W	RS	CB15	CB14	CB13	CB12	CB11	CB10	CB9	CB8	CB7	CB6	CB5	CB4	CB3	CB2	CB1	CB0
W	1	0	0	0	0	0	NOWI2 (0)	NOWI1 (0)	NOWI0 (0)	0	0	0	0	0	SDTI2 (0)	SDTI1 (0)	SDTI0 (0)

NOWI [2:0]: Set the adjacent gate driver output non-overlap period. **Table 6-18** summarized the function of NOWI2-0 setting.

Table 6-18

NOWI2	NOWI1	NOWI0	Gate output non-overlap period Internal Operation (reference clock: internal oscillator)
0	0	0	0 clock
0	0	1	1 clocks
0	1	0	2 clocks
0	1	1	3 clocks
1	0	0	4 clocks
1	0	1	5 clocks
1	1	0	6 clocks
1	1	1	7 clocks

SDTI2-0: Set the delay of source output in every line.

Table 6-19

SDTI2	SDTI1	SDTI0	Source output delay period Internal Operation (reference clock: internal oscillator)
0	0	0	0 clock
0	0	1	1 clocks
0	1	0	2 clocks
0	1	1	3 clocks
1	0	0	4 clocks
1	0	1	5 clocks
1	1	0	6 clocks
1	1	1	7 clocks

6.2.14. Panel Interface control 3 (R012h)

R/W	RS	CB15	CB14	CB13	CB12	CB11	CB10	CB9	CB8	CB7	CB6	CB5	CB4	CB3	CB2	CB1	CB0
W	1	0	0	0	0	0	VEQW1 (0)	VEQW0 (0)	0	0	0	0	0	0	0	0	0

VEQW1[1:0]: Set VCOM equalize period.

Table 6-20

VEQW1	VEQW0	VCOM Equalize Period
0	0	0 clock
0	1	1 clock
1	0	2 clocks
1	1	3 clocks

6.2.15. Panel Interface control 4 (R020h)

R/W	RS	CB15	CB14	CB13	CB12	CB11	CB10	CB9	CB8	CB7	CB6	CB5	CB4	CB3	CB2	CB1	CB0
W	1	0	0	0	0	0	0	DIVE1 (1)	DIVE0 (0)	0	RTNE6 (0)	RTNE5 (0)	RTNE4 (1)	RTNE3 (1)	RTNE2 (1)	RTNE1 (1)	RTNE0 (0)

RTNE6-0: Set the clock cycle per line **Table 6-21** summarized the function of RTNE5-0 setting.

Table 6-21

RTNE5	RTNE4	RTNE3	RTNE2	RTNE1	RTNE0	Clock Cycles per line
0	0	0	0	0	0	Setting disable
Setting disable						
0	1	0	0	0	0	16 clocks
0	1	0	0	0	1	17 clocks
0	1	0	0	1	0	18 clocks
0	1	0	0	1	1	19 clocks
0	1	0	1	0	0	20 clocks
0	1	0	1	0	1	21 clocks
0	1	0	1	1	0	22 clocks
0	1	0	1	1	1	23 clocks
0	1	1	0	0	0	24 clocks
0	1	1	0	0	1	25 clocks
0	1	1	0	1	0	26 clocks
0	1	1	0	1	1	27 clocks
0	1	1	1	0	0	28 clocks
0	1	1	1	0	1	29 clocks
0	1	1	1	1	0	30 clocks
0	1	1	1	1	1	31 clocks
1	0	0	0	0	0	32 clocks
1	0	0	0	0	1	33 clocks
1	0	0	0	1	0	34 clocks

RTNE5	RTNE4	RTNE3	RTNE2	RTNE1	RTNE0	Clock Cycles per line
1	0	0	0	1	1	35 clocks
1	0	0	1	0	0	36 clocks
1	0	0	1	0	1	37 clocks
1	0	0	1	1	0	38 clocks
1	0	0	1	1	1	39 clocks
1	0	1	0	0	0	40 clocks
1	0	1	0	0	1	41 clocks
1	0	1	0	1	0	42 clocks
1	0	1	0	1	1	43 clocks
1	0	1	1	0	0	44 clocks
1	0	1	1	0	1	45 clocks
1	0	1	1	1	0	46 clocks
1	0	1	1	1	1	47 clocks
1	1	0	0	0	0	48 clocks
1	1	0	0	0	1	49 clocks
1	1	0	0	1	0	50 clocks
1	1	0	0	1	1	51 clocks
1	1	0	1	0	0	52 clocks
1	1	0	1	0	1	53 clocks
1	1	0	1	1	0	54 clocks
1	1	0	1	1	1	55 clocks
1	1	1	0	0	0	56 clocks
1	1	1	0	0	1	57 clocks
1	1	1	0	1	0	58 clocks
1	1	1	0	1	1	59 clocks
1	1	1	1	0	0	60 clocks
1	1	1	1	0	1	61 clocks
1	1	1	1	1	0	62 clocks
1	1	1	1	1	1	63 clocks

DIVE1-0: To specified the division ratio of internal operation clock frequency. Set the RTNE and DIVE bits to adjust frame frequency. Be aware of that if the number of lines for driving liquid crystal is changed, the frame frequency must also be adjusted. Moreover, In RGB interface mode, the DIVE1-0 bits are disabled. **Table 6-22** summarized the function of DIVE1-0 setting.

Table 6-22

DIVE1	DIVE0	Division Ratio	Internal Operation Clock Frequency (16 bit, one time transfer)	Internal Operation Clock Frequency (8 bit, three time transfer)
0	0		Setting disable	
0	1	4	fosc / 4	fosc / 12
1	0	8	fosc / 8	fosc / 24
1	1	16	fosc / 16	fosc / 48

fosc =Frequency of RC oscillation

6.2.16. Panel Interface Control 5 (021Rh)

R/W	RS	CB15	CB14	CB13	CB12	CB11	CB10	CB9	CB8	CB7	CB6	CB5	CB4	CB3	CB2	CB1	CB0
W	1	0	0	0	0	NOW E3(0)	NOW E2(0)	NOW E1(0)	NOW E0(0)	0	0	0	0	SDT E3(0)	SDT E2(0)	SDT E1(0)	SDT E0(0)

NOWE [3:0]: Set the adjacent gate driver output non-overlap period in RGB interface. **Table 6-23** summarized the function of NOWE3-0 setting.

SDTE: Set the source output delay in RGB interface.

Table 6-23

NOWE3	NOWE2	NOWE1	NOWE0	Gate output non-overlap period Internal Operation (reference clock: internal oscillator)
0	0	0	0	0 clock
0	0	0	1	1 clocks
0	0	1	0	2 clocks
0	0	1	1	3 clocks
0	1	0	0	4 clocks
0	1	0	1	5 clocks
0	1	1	0	6 clocks
0	1	1	1	7 clocks
1	0	0	0	8 clocks
1	0	0	1	9 clocks
1	0	1	0	10 clocks
1	0	1	1	11 clocks
1	1	0	0	12 clocks
1	1	0	1	13 clocks
1	1	1	0	14 clocks
1	1	1	1	15 clocks

Table 6-24

SDTE3	SDTE 2	SDTE 1	SDTE 0	Source output period Internal Operation (reference clock: internal oscillator)
0	0	0	0	0 clock
0	0	0	1	1 clocks
0	0	1	0	2 clocks
0	0	1	1	3 clocks
0	1	0	0	4 clocks
0	1	0	1	5 clocks
0	1	1	0	6 clocks
0	1	1	1	7 clocks
1	0	0	0	8 clocks
1	0	0	1	9 clocks
1	0	1	0	10 clocks
1	0	1	1	11 clocks
1	1	0	0	12 clocks
1	1	0	1	13 clocks
1	1	1	0	14 clocks
1	1	1	1	15 clocks

6.2.17. Panel Interface Control 6 (R022h)

R/W	RS	CB15	CB14	CB13	CB12	CB11	CB10	CB9	CB8	CB7	CB6	CB5	CB4	CB3	CB2	CB1	CB0
W	1	0	0	0	0	0	VEQ	VEQ	VEQ	0	0	0	0	0	0	0	0
							WE2(0)	WE1(0)	WE0(0)								

VEQWE2-0: To set the drive period of low power VCOM, which is valid when the operation is synchronized with RGB interface signals.

Table 6-25

VEQWE2	VEQWE1	VEQWE0	Source Output Delay Perios
0	0	0	0 clock
0	0	1	1 clocks
0	1	0	2 clocks
0	1	1	3 clocks
1	0	0	4 clocks
1	0	1	5 clocks
1	1	0	6 clocks
1	1	1	7 clocks

6.2.18. CABC Write Display Brightness (R051h)

R/W	RS	CB15	CB14	CB13	CB12	CB11	CB10	CB9	CB8	CB7	CB6	CB5	CB4	CB3	CB2	CB1	CB0
W	1	0	0	0	0	0	0	0	0	DBV7	DBV6	DBV5	DBV4	DBV3	DBV2	DBV1	DBV0

This command is used to adjust the brightness value of the display.

It should be checked what the relationship between this written value and output brightness of the display is. This relationship is defined on the display module specification. In principle relationship is that 00h value means the lowest brightness and FFh value means the highest brightness.

6.2.19. CABC Read Display Brightness (R052h)

R/W	RS	CB15	CB14	CB13	CB12	CB11	CB10	CB9	CB8	CB7	CB6	CB5	CB4	CB3	CB2	CB1	CB0
W	1	0	0	0	0	0	0	0	0	DBV7	DBV6	DBV5	DBV4	DBV3	DBV2	DBV1	DBV0

This command returns the brightness value of the display. It should be checked what the relationship between this returned value and output brightness of the display. This relationship is defined on the display module specification is. In principle the relationship is that 00h value means the lowest brightness and FFh value means the highest brightness.

6.2.20. CABC Write Control Display (R053h)

R/W	RS	CB15	CB14	CB13	CB12	CB11	CB10	CB9	CB8	CB7	CB6	CB5	CB4	CB3	CB2	CB1	CB0
W	1	0	0	0	0	0	0	0	0	BC_O UT_IN V	LED_O N	BCTRL	0	DD	BL	0	0

This command is used to control brightness and gamma settings.

BCTRL : Brightness control block on/off, This bit is always used to switch brightness for display.

0 = off (brightness registers are 00h)

1 = on (brightness registers are active)

DD : Display dimming

0 = Display dimming is off.

1 = Display dimming is on.

BL : Backlight control on/off

0 = off (completely turn off backlight circuit)

1 = on

LEDON : Backlight LED control signal.

0 = off

1 = on

BC_OUT_INV : Inverse the polarity of LEDPWM signal

0 = no inversion

1 = inversion

6.2.21. CABC Read Control Display (R054h)

R/W	RS	CB15	CB14	CB13	CB12	CB11	CB10	CB9	CB8	CB7	CB6	CB5	CB4	CB3	CB2	CB1	CB0
W	1	0	0	0	0	0	0	0	0	BC_O UT_IN V	LED_O N	BCTRL	0	DD	BL	0	0

This command is used to read control brightness and gamma settings back.

BCTRL : Brightness control block on/off, This bit is always used to switch brightness for display.

0 = off (brightness registers are 00h)

1 = on (brightness registers are active)

DD : Display dimming

0 = Display dimming is off.

1 = Display dimming is on.

BL : Backlight control on/off

0 = off (completely turn off backlight circuit)

1 = on

LEDON : Backlight LED control signal.

0 = off

1 = on

BC_OUT_INV : Inverse the polarity of LEDPWM signal

0 = no inversion

1 = inversion

6.2.22. Write Content Adaptive Brightness Control (R055h)

R/W	RS	CB15	CB14	CB13	CB12	CB11	CB10	CB9	CB8	CB7	CB6	CB5	CB4	CB3	CB2	CB1	CB0
W	1	0	0	0	0	0	0	0	0	0	0	0	0	0	0	C1	C0

This command is used to set parameters for image content based adaptive brightness control functionality.

C1	C0	Function
0	0	Off
0	1	User Interface Image
1	0	Still Picture
1	1	Moving Image

6.2.23. Read Content Adaptive Brightness Control (R056h)

R/W	RS	CB15	CB14	CB13	CB12	CB11	CB10	CB9	CB8	CB7	CB6	CB5	CB4	CB3	CB2	CB1	CB0
W	1	0	0	0	0	0	0	0	0	0	0	0	0	0	0	C1	C0

This command is used to read parameters for image content based adaptive brightness control functionality back.

C1	C0	Function
0	0	Off
0	1	User Interface Image
1	0	Still Picture
1	1	Moving Image

6.2.24. Write CABC minimum brightness (R05Eh)

R/W	RS	CB15	CB14	CB13	CB12	CB11	CB10	CB9	CB8	CB7	CB6	CB5	CB4	CB3	CB2	CB1	CB0
W	1	0	0	0	0	0	0	0	0	CMB7	CMB6	CMB5	CMB4	CMB3	CMB2	CMB1	CMB0

This command is used to set the minimum brightness value of the display for CABC function.

In principle relationship is that 00h value means the lowest brightness for CABC and FFh value means the high brightness for CABC.

6.2.25. Read CABC minimum brightness (R05Fh)

R/W	RS	CB15	CB14	CB13	CB12	CB11	CB10	CB9	CB8	CB7	CB6	CB5	CB4	CB3	CB2	CB1	CB0
W	1	0	0	0	0	0	0	0	0	CMB7	CMB6	CMB5	CMB4	CMB3	CMB2	CMB1	CMB0

This command returns the minimum brightness value of CABC function.

In principle relationship is that 00h value means the lowest brightness for CABC and FFh value means the high brightness for CABC.

6.2.26. Frame Marker Control (R090h)

R/W	RS	CB15	CB14	CB13	CB12	CB11	CB10	CB9	CB8	CB7	CB6	CB5	CB4	CB3	CB2	CB1	CB0
W	1	FMKM (0)	FMI2 (0)	FMI1 (0)	FMI0 (0)	0	0	0	FMP8 (0)	FMP7 (0)	FMP6 (0)	FMP5 (0)	FMP4 (0)	FMP3 (0)	FMP2 (0)	FMP1 (0)	FMP0 (0)

FMP8-0: Set the position of the frame marker. $0 \leq \text{FMP} \leq \text{BP} + \text{NL} + \text{FP}$

Table 6-26

FMP8-0	Frame Marker Position
00000000	0
00000001	1
00000010	2
00000011	3
...	...
11011100	444
11011101	445
11011110	446
11011111	447

FMI2-0: Set the period of the Frame Marker.

Table 6-27

FMI2	FMI1	FMI0	Period of FMARK
0	0	0	1 frame
0	1	1	2 frames
1	0	1	4 frames
1	1	1	6 frames

FMKM:

- 0: Disable FMARK
- 1: Enable FMARK

6.2.27. Power Control 1 (R100h)

R/W	RS	CB15	CB14	CB13	CB12	CB11	CB10	CB9	CB8	CB7	CB6	CB5	CB4	CB3	CB2	CB1	CB0
W	1	0	0	0	SAP (0)	0	BT2 (0)	BT1 (0)	BT0 (0)	APE (0)	AP2 (1)	AP1 (0)	AP0 (0)	0	DSTB (0)	SLP (0)	0

SLP: Sleep mode selection. When SLP =1, OTM4001A set to sleep mode. In sleep mode, all internal operations are terminated except internal RC oscillation. Be sure that a display off sequence should be executed before set SLP to "1". In sleep mode, no instruction can be accepted. Set STB=0 can exit sleep mode. Moreover, when exit from sleep mode, data in GRAM and in instruction registers are remained unchanged.

DSTB: Deep Standby mode selection. When DSTB =1, OTM4001A set to deep standby mode. In this mode, all internal operations are terminated including internal RC oscillation. Be sure that a display off sequence should be executed before set DSTB to "1". Set DSTB=0 can exit standby mode. Be sure that start oscillation following by 10ms delay should be executed before set DSTB to "0". Moreover, when exit from deep standby mode, data in GRAM and register would be lost, reset and re-sending command and data into GRAM are necessary.

AP2-0: Operational amplifier DC bias current adjustment. Set AP2-0 = "000" to stop operational amplifier and DC/DC charge

BT3-0: Set the voltage level of DDVDH, VGH, VGL and VCL.

Table 6-29 summarized the function of BT2-0 setting

BT2	BT1	BT0	DDVDH	VGH	VGL	VCL	Capacitor connection pins
0	0	0	VCI1 x 2 [VCI1x2]	DDVDH x 3 [VCI1 x 6]	-(VCI1+DDVDHx 2) [VCI1x -5]	-VCI1 [VCI1x-1]	
0	0	1	VCI1 x 2 [VCI1x2]	DDVDH x 3 [VCI1 x 6]	-(DDVDHx 2) [VCI1x -4]	-VCI1 [VCI1x-1]	Setting Disabled
0	1	0	VCI1 x 2 [VCI1x2]	DDVDH x 3 [VCI1 x 6]	-(VCI1+DDVDH) [VCI1x -3]	-VCI1 [VCI1x-1]	Setting Disabled
0	1	1	VCI1 x 2 [x2]	DDVDH x 3 - VCI1 [VCI1 x 5]	-(VCI1+DDVDHx 2) [VCI1x -5]	-VCI1 [VCI1x-1]	
1	0	0	VCI1 x 2 [x2]	DDVDH x 3 - VCI1 [VCI1 x 5]	-(DDVDHx 2) [VCI1x -4]	-VCI1 [VCI1x-1]	
1	0	1	VCI1 x 2 [x2]	DDVDH x 3 - VCI1 [VCI1 x 5]	-(VCI1+DDVDH) [VCI1x -3]	-VCI1 [VCI1x-1]	
1	1	0	VCI1 x 2 [x2]	DDVDH x 2 [VCI1 x 4]	-(DDVDHx 2) [VCI1x -4]	-VCI1 [VCI1x-1]	
1	1	1	VCI1 x 2 [x2]	DDVDH x 2 [VCI1 x 4]	-(VCI1+DDVDH) [VCI1x -3]	-VCI1 [VCI1x-1]	

SAP: Enable bit for gamma voltage generation circuit.

SAP="0", Halt gamma voltage generation circuit.

SAP="1", Enable gamma voltage generation circuit.

pump circuits to reduce current consumption during non display period. **Table 6-28** summarized the function of AP2-0 setting. Please note that the values listed in the table are the ratios of the currents of the corresponding settings to the current at the max rank.

Table 6-28

AP2	AP1	AP0	Constant current in power supply circuit	Constant current in Gamma circuit
0	0	0	Halt	Halt
0	0	1	0.5	0.5
0	1	0	0.6	0.6
0	1	1	0.8	0.8
1	0	0	1	1
1	0	1	1.2	1.2
1	1	0	1.4	1.4
1	1	1	1.9	1.9

APE: Enable bit for both liquid crystal power supply and gamma voltage generation circuit.

APE="0", Halt liquid crystal power supply and gamma voltage generation circuit

APE="1", Enable liquid crystal power supply and gamma voltage generation circuit.

6.2.28. Power Control 2 (R101h)

R/W	RS	CB15	CB14	CB13	CB12	CB11	CB10	CB9	CB8	CB7	CB6	CB5	CB4	CB3	CB2	CB1	CB0
W	1	0	0	0	0	0	DC12 (1)	DC11 (1)	DC10 (0)	0	DC02 (1)	DC01 (1)	DC00 (0)	0	VC2 (0)	VC1 (0)	VC0 (0)

VC2-0: Set the voltage of **VC1**. **VC1** is generated by VCILVL.
Table 6-30 summarized the function of VC2-0 setting

Table 6-30

VC2	VC1	VC0	VC1
0	0	0	0.94 x VCILVL
0	0	1	0.89 x VCILVL
0	1	0	Setting Disable
0	1	1	Setting Disable
1	0	0	0.76 x VCILVL
1	0	1	Setting Disable
1	1	0	Setting Disable
1	1	1	1.00 x VCILVL

DC02-00: Set DC/DC charge pump circuit 1 operating frequency.
Table 6-31 summarized the function of DC02-00 setting

Table 6-31

DC02	DC01	DC00	DC/DC charge pump circuit 1 frequency (fDCDC1)
0	0	0	Oscillation clock
0	0	1	Oscillation clock / 2
0	1	0	Oscillation clock / 4
0	1	1	Oscillation clock / 8
1	0	0	Oscillation clock / 16
1	0	1	Invalid Setting
1	1	0	Invalid Setting
1	1	1	Invalid Setting

DC12-10: Set DC/DC charge pump circuit 2 operating frequency.

Table 6-32 summarized the function of DC12-10 setting

Table 6-32

DC12	DC11	DC10	Step-up circuit 2 step-up frequency (fDCDC2)
0	0	0	Oscillation clock / 16
0	0	1	Oscillation clock / 32
0	1	0	Oscillation clock / 64
0	1	1	Oscillation clock / 128
1	0	0	Oscillation clock / 256
1	0	1	Setting disabled
1	1	0	Setting disabled
1	1	1	Setting disabled

6.2.29. Power Control 3 (R102h)

R/W	RS	CB15	CB14	CB13	CB12	CB11	CB10	CB9	CB8	CB7	CB6	CB5	CB4	CB3	CB2	CB1	CB0
W	1	0	0	0	0	0	0	0	VCM R0(0)	VRE G1R(0)	0	0	0	VRH3 (0)	VRH2 (0)	VRH1 (0)	VRH0 (0)

VRH3-0: Set the voltage level of VREG1OUT, which generated from VCILVL. **Table 6-33** summarized the function of VRH3-0 setting

Table 6-33

VRH3	VRH2	VRH1	VRH0	VREG1OUT voltage		VRH3	VRH2	VRH1	VRH0	VREG1OUT voltage	
				VCILVL	VCIR					VCILVL	VCIR
0	0	0	0	Halt	Halt	1	0	0	0	VCILVLx1.6	2.5Vx1.6
0	0	0	1	Halt	Halt	1	0	0	1	VCILVLx1.65	2.5Vx1.65
0	0	1	0	Halt	Halt	1	0	1	0	VCILVLx1.7	2.5Vx1.7
0	0	1	1	Halt	Halt	1	0	1	1	VCILVLx1.75	2.5Vx1.75
0	1	0	0	Setting disable	Setting disable	1	1	0	0	VCILVLx1.8	2.5Vx1.8
0	1	0	1	Setting disable	Setting disable	1	1	0	1	VCILVLx1.85	2.5Vx1.85
0	1	1	0	Setting disable	Setting disable	1	1	1	0	VCILVLx1.9	2.5Vx1.9
0	1	1	1	Setting disable	Setting disable	1	1	1	1	Setting disable	Setting disable

VREG1R: Select reference voltage for VREG1OUT

VREG1R = "0" (default): VCILVL (External) as reference voltage for VREG1OUT.

VREG1R = "1": VCIR (internal) as reference voltage for VREG1OUT.

VCMR[0]: Select VCOMH external resistance or internal setting for VCOMH voltage level.

VCMR[0] = "0" use VCOMR (External) setting as VCOMH voltage.

VCMR[0] = "1": use register (Internal) setting as VCOMH voltage.

6.2.30. Power Control 4 (R103h)

R/W	RS	CB15	CB14	CB13	CB12	CB11	CB10	CB9	CB8	CB7	CB6	CB5	CB4	CB3	CB2	CB1	CB0
W	1	0	0	0	VDV4 (0)	VDV3 (0)	VDV2 (0)	VDV1 (0)	VDV0 (0)	0	0	0	0	0	0	0	0

VDV4-0: Set the Vcom amplitude. Vcom amplitude is generated from VREG1OUT, the coefficient is valid from 0.7 to 1.24.

Table 6-34

VDV4	VDV3	VDV2	VDV1	VDV0	Vcom amplitude
0	0	0	0	0	VREG1OUT x 0.70
0	0	0	0	1	VREG1OUT x 0.72
0	0	0	1	0	VREG1OUT x 0.74
0	0	0	1	1	VREG1OUT x 0.76
0	0	1	0	0	VREG1OUT x 0.78
0	0	1	0	1	VREG1OUT x 0.80
0	0	1	1	0	VREG1OUT x 0.82
0	0	1	1	1	VREG1OUT x 0.84
0	1	0	0	0	VREG1OUT x 0.86
0	1	0	0	1	VREG1OUT x 0.88
0	1	0	1	0	VREG1OUT x 0.90
0	1	0	1	1	VREG1OUT x 0.92
0	1	1	0	0	VREG1OUT x 0.94
0	1	1	0	1	VREG1OUT x 0.96
0	1	1	1	0	VREG1OUT x 0.98
0	1	1	1	1	VREG1OUT x 1.00
1	0	0	0	0	VREG1OUT x 1.02
1	0	0	0	1	VREG1OUT x 1.04
1	0	0	1	0	VREG1OUT x 1.06
1	0	0	1	1	VREG1OUT x 1.08
1	0	1	0	0	VREG1OUT x 1.10
1	0	1	0	1	VREG1OUT x 1.12
1	0	1	1	0	VREG1OUT x 1.14
1	0	1	1	1	VREG1OUT x 1.16
1	1	0	0	0	VREG1OUT x 1.18
1	1	0	0	1	VREG1OUT x 1.20
1	1	0	1	0	VREG1OUT x 1.22
1	1	0	1	1	VREG1OUT x 1.24
1	1	1	0	0	Setting Disabled
1	1	1	0	1	
1	1	1	1	0	
1	1	1	1	1	

6.2.31. GRAM Address Set (Horizontal Address) (R200h)

R/W	RS	CB15	CB14	CB13	CB12	CB11	CB10	CB9	CB8	CB7	CB6	CB5	CB4	CB3	CB2	CB1	CB0
W	1	0	0	0	0	0	0	0	0	AD7	AD6	AD5	AD4	AD3	AD2	AD1	AD0

See R201h.

6.2.32. GRAM Address Set (Vertical Address) (R201h)

R/W	RS	CB15	CB14	CB13	CB12	CB11	CB10	CB9	CB8	CB7	CB6	CB5	CB4	CB3	CB2	CB1	CB0
W	1	0	0	0	0	0	0	0	AD16	AD15	AD14	AD13	AD12	AD11	AD10	AD9	AD8

AD16-0: To set the initial address counter for GRAM address.

Based on AM and I/D[1:0] setting, the address counter is automatically increment or decrement while data are written to the internal GRAM. There is no need to update AD16-0 every data transfer if AD16-0 was set in the beginning of one frame graphic data. Be aware that address counter is not automatically updated if reading data from the internal GRAM instruction is executed. Moreover, the address counter cannot be accessed when the OTM4001A is in standby mode.

Table 6-35 summarized the function of AD15-0 setting

Table 6-35

AD16-AD0	GRAM Setting
"00000"H – "000EF"H	Bitmap data for G1
"00100"H – "001EF"H	Bitmap data for G2
"00200"H – "002EF"H	Bitmap data for G3
"00300"H – "003EF"H	Bitmap data for G4
:	:
"1AC00"H – "1ACEF"H	Bitmap data for G399
"1AD00"H – "1ADEF"H	Bitmap data for G430
"1AE00"H – "1AEEF"H	Bitmap data for G431
"1AF00"H – "1AFEF"H	Bitmap data for G432

Note1: The address AD16-0 should be set in the address counter every frame on the falling edge of VSYNC if RGB interface mode is selected.

Note2: The address AD16-0 should be set when executing an instruction if system or VSYNC interface mode is selected.

6.2.33. Write Data to GRAM (R202h)

R/W	RS	CB15	CB14	CB13	CB12	CB11	CB10	CB9	CB8	CB7	CB6	CB5	CB4	CB3	CB2	CB1	CB0
W	1	RAM write data (WD17-0) The DB17-0 pin assignment is different in different transferring modes.															

WD17-0: OTM4001A supports 18 bits data format. However, if only 16-bit (565format) is input to GRAM, OTM4001A will expand the 16 bit data into 18-bit format. Same case when RGB interface is selected. Based on the graphic data in GRAM, the grayscale voltage of source driver is selected. **Table 6-36** summarized the source driver grayscale voltage output versus graphic data in GRAM.

Figure 6-8 ~ Figure 6-18 illustrates the pin assignment among data bus (DB17-0), (WD17-0) and GRAM.

Table 6-36

Data in GRAM	Source Driver Grayscale Output – REV=1 (REV=0)	
RGB	Negative(Postive)	Positive(Negative)
000000	V31	V0
000001	(V30+V31)/2	(V1+V0)/2
000010	V30	V1
000011	(V29+V30)/2	(V2+V1)/2
000100	V29	V2
000101	(V29+V28)/2	(V3+V2)/2
000110	V28	V3
000111	(V28+V27)/2	(V4+V3)/2
001000	V27	V4
001001	(V27+V26)/2	(V5+V4)/2
001010	V26	V5
001011	(V26+V25)/2	(V6+V5)/2
001100	V25	V6
001101	(V25+V24)/2	(V7+V6)/2
001110	V24	V7
001111	(V24+V23)/2	(V8+V7)/2
010000	V23	V8
010001	(V23+V22)/2	(V9+V8)/2
010010	V22	V9
010011	(V22+V21)/2	(V10+V9)/2
010100	V21	V10
010101	(V21+V20)/2	(V11+V10)/2
010110	V20	V11
010111	(V20+V19)/2	(V12+V11)/2
011000	V19	V12
011001	(V19+V18)/2	(V12+V11)/2
011010	V18	V13
011011	(V18+V17)/2	(V13+V12)/2
011100	V17	V14

Data in GRAM	Source Driver Grayscale Output – REV=1 (REV=0)	
RGB	Negative(Postive)	Positive(Negative)
011101	(V17+V16)/2	(V14+V13)/2
011110	V16	V15
011111	(V16+V15)/2	(V16+V15)/2
100000	V15	V16
100001	(V15+V14)/2	(V17+V16)/2
100010	V14	V17
100011	(V14+V13)/2	(V18+V17)/2
100100	V13	V18
100101	(V13+V12)/2	(V19+V18)/2
100110	V12	V19
100111	(V12+V11)/2	(V20+V19)/2
101000	V11	V20
101001	(V11+V10)/2	(V21+V20)/2
101010	V10	V21
101011	(V10+V9)/2	(V22+V21)/2
101100	V9	V22
101101	(V9+V8)/2	(V23+V22)/2
101110	V8	V23
101111	(V8+V7)/2	(V24+V23)/2
110000	V7	V24
110001	(V7+V6)/2	(V25+V24)/2
110010	V6	V25
110011	(V6+V5)/2	(V26+V25)/2
110100	V5	V26
110101	(V5+V4)/2	(V27+V26)/2
110110	V4	V27
110111	(V4+V3)/2	(V28+V27)/2
111000	V3	V28
111001	(V3+V2)/2	(V29+V28)/2
111010	V2	V29
111011	(V2+V1)/2	(V29+V30)/2
111100	V1	V30
111101	(V1+V0)/2	(V30+V31)/2
111110	(V1+2V0)/2	(V30+2V31)/2
111111	V0	V31

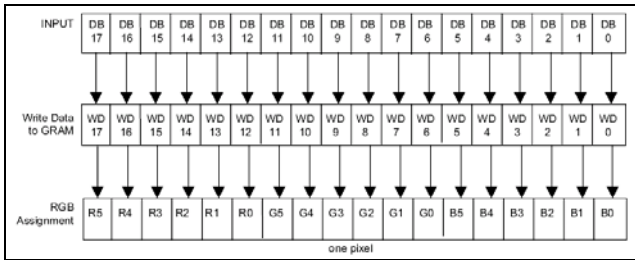

Figure 6-8 18-bit interface (262,144 colors)

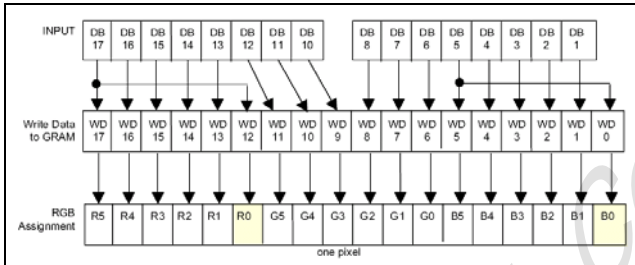

Figure 6-9 16-bit interface (65,536 colors) TRIREG=0

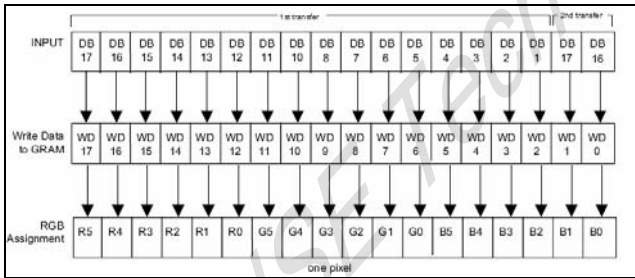

Figure 6-10 16-bit interface (262,144 colors) TRIREG=1, DFM=0

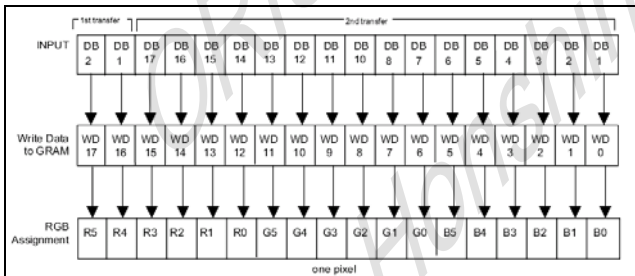

Figure 6-11 16-bit interface (262,144 colors) TRIREG=1, DFM=1

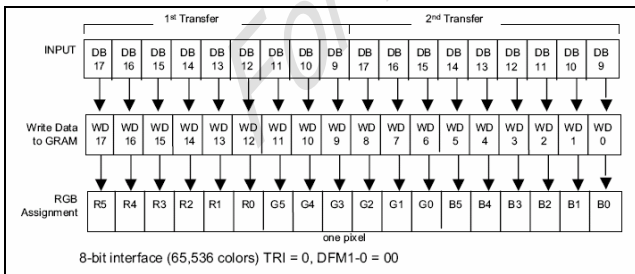

Figure 6-12 9-bit interface (262,144 colors)

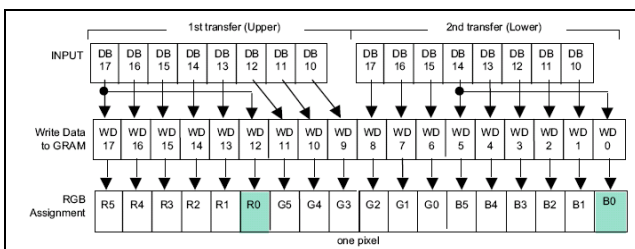

Figure 6-13 8-bit interface (65,536 colors) TRIREG=0

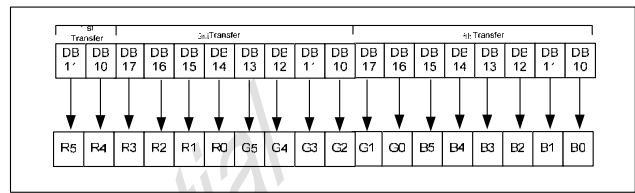

Figure 6-14 8-bit interface (262 colors) TRIREG=1, DFM=0.

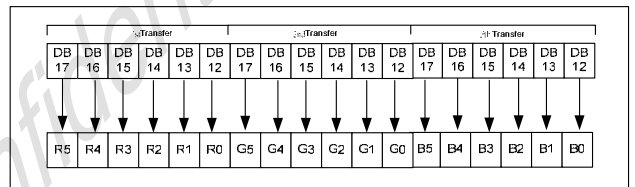

Figure 6-15 8-bit interface (262K colors) TRIREG=1, DFM=1

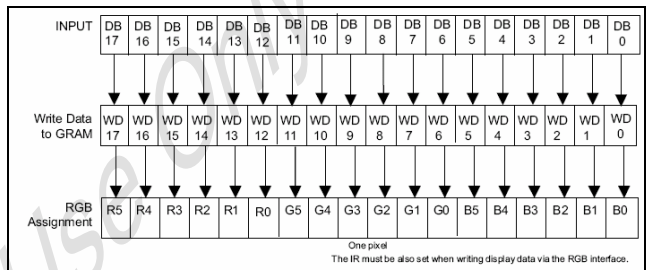

Figure 6-16 18-bit RGB interface (262,144 colors)

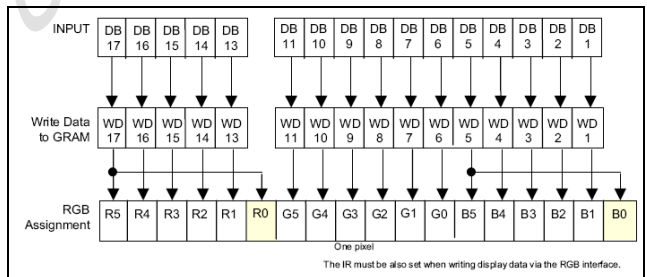

Figure 6-17 16-bit RGB interface (65,563 colors)

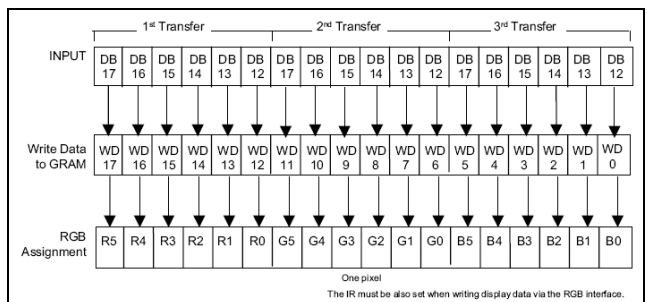

Figure 6-18 6-bit RGB interface (262,144 colors)

OTM4001A supports external (RGB) interface. In RGB interface mode, all graphic data are stored in GRAM. To meet the diverse requirement of small size LCD panel, OTM4001A also supports in a fix window using RGB interface and outside the window still use system interface.

In RGB interface mode, data writing to the internal RAM is synchronized with DOTCLK during ENABLE = "Low". Set ENABLE "High" to terminate writing data to RAM. Wait for a write/read bus cycle time. If accessing internal RAM using the RGB interface is desired after accessing the RAM via the system interface. **Figure 6-19** illustrates the timing diagram while RGB and system interface are both use in the same time.

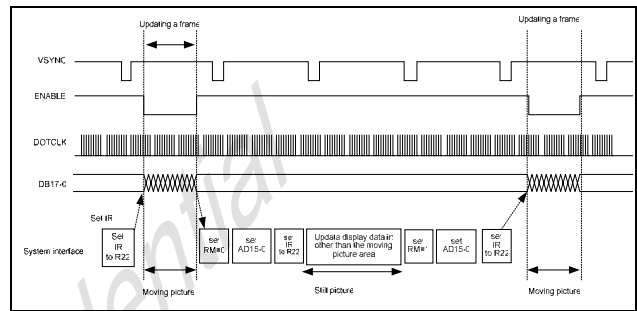

Figure 6-19

6.2.34. Read Data Read from GRAM (R202h)

R/W	RS	CB15	CB14	CB13	CB12	CB11	CB10	CB9	CB8	CB7	CB6	CB5	CB4	CB3	CB2	CB1	CB0
W	1	RAM Read data (RD17-0) The DB17-0 pin assignment is different in different transferring modes.															

R202 also served as a register, which store the data read out from GRAM. When data are read out from the GRAM is desired, first sets the RAM address and executes first word read, and issues second word read. When first word read instruction is issued, Invalid data are sent to the data bus DB17-0. Valid data are sent to the data bus as second word data is executed.

The LSBs of R and B dots cannot read out, when the 8 or 16-bit interface is selected,

Note: This register is not available with the RGB interface. **Figure 6-20** and

Figure 6-23 illustrates the pin assignment among data bus (DB17-0), R22 (RD17-0) and GRAM in read data instruction.

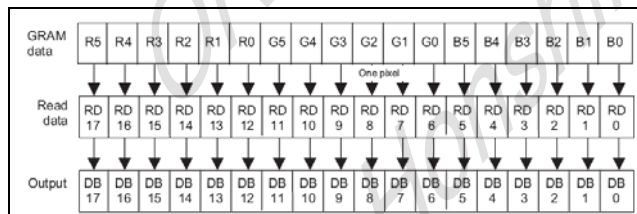

Figure 6-20 18-bit interface

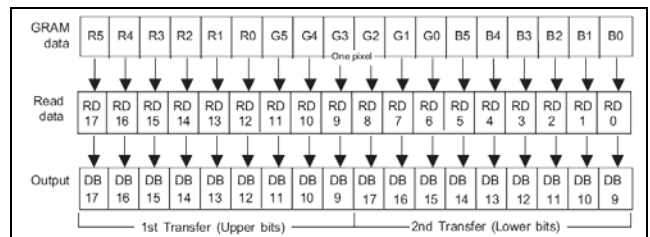

Figure 6-22 9-bit interface

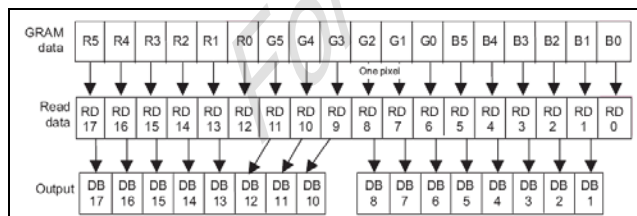

Figure 6-21 16-bit interface

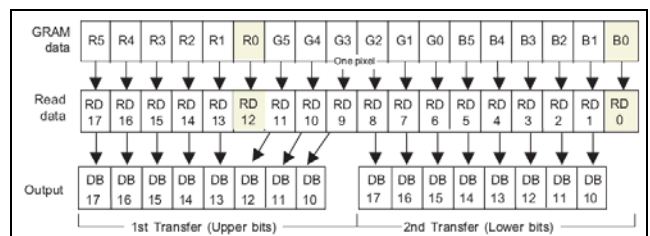

Figure 6-23 8-bit interface / SPI

6.2.35. NVM read data 2 (R281h)

R/W	RS	CB15	CB14	CB13	CB12	CB11	CB10	CB9	CB8	CB7	CB6	CB5	CB4	CB3	CB2	CB1	CB0
W	1	0	0	0	0	0	0	0	0	0	0	0	VCM 14(0)	VCM 13(0)	VCM 12(0)	VCM 11(0)	VCM 10(0)

See R282h

6.2.36. NVM read data 3 (R282h)

R/W	RS	CB15	CB14	CB13	CB12	CB11	CB10	CB9	CB8	CB7	CB6	CB5	CB4	CB3	CB2	CB1	CB0
W	1	0	0	0	0	0	0	0	0	VCM SEL	0	0	VCM 24(0)	VCM 23(0)	VCM 22(0)	VCM 21(0)	VCM 20(0)

VC1M1 [4:0]: These pins are to set the factor for generating VCOMH when VCMSEL="0". **Table 6-37** summarized the the factor of VREG1OUT

VC1M2 [4:0]: These pins are to set the factor for generating VCOMH when VCMSEL="1". **Table 6-38** summarized the the factor of VREG1OUT

Table 6-37

VC1M1[4:0]	VCOMH voltage
5'h00	VREG1OUT x 0.69
5'h01	VREG1OUT x 0.70
5'h02	VREG1OUT x 0.71
5'h03	VREG1OUT x 0.72
5'h04	VREG1OUT x 0.73
5'h05	VREG1OUT x 0.74
5'h06	VREG1OUT x 0.75
5'h07	VREG1OUT x 0.76
5'h08	VREG1OUT x 0.77
5'h09	VREG1OUT x 0.78
5'h0A	VREG1OUT x 0.79
5'h0B	VREG1OUT x 0.80
5'h0C	VREG1OUT x 0.81
5'h0D	VREG1OUT x 0.82
5'h0E	VREG1OUT x 0.83
5'h0F	VREG1OUT x 0.84
5'h10	VREG1OUT x 0.85
5'h11	VREG1OUT x 0.86
5'h12	VREG1OUT x 0.87
5'h13	VREG1OUT x 0.88
5'h14	VREG1OUT x 0.89
5'h15	VREG1OUT x 0.90
5'h16	VREG1OUT x 0.91
5'h17	VREG1OUT x 0.92
5'h18	VREG1OUT x 0.93
5'h19	VREG1OUT x 0.94
5'h1A	VREG1OUT x 0.95
5'h1B	VREG1OUT x 0.96
5'h1C	VREG1OUT x 0.97
5'h1D	VREG1OUT x 0.98
5'h1E	VREG1OUT x 0.99
5'h1F	VREG1OUT x 1.00

Table 6-38

VC1M2[4:0]	VCOMH voltage
5'h00	VREG1OUT x 0.69
5'h01	VREG1OUT x 0.70
5'h02	VREG1OUT x 0.71
5'h03	VREG1OUT x 0.72
5'h04	VREG1OUT x 0.73
5'h05	VREG1OUT x 0.74
5'h06	VREG1OUT x 0.75
5'h07	VREG1OUT x 0.76
5'h08	VREG1OUT x 0.77
5'h09	VREG1OUT x 0.78
5'h0A	VREG1OUT x 0.79
5'h0B	VREG1OUT x 0.80
5'h0C	VREG1OUT x 0.81
5'h0D	VREG1OUT x 0.82
5'h0E	VREG1OUT x 0.83
5'h0F	VREG1OUT x 0.84
5'h10	VREG1OUT x 0.85
5'h11	VREG1OUT x 0.86
5'h12	VREG1OUT x 0.87
5'h13	VREG1OUT x 0.88
5'h14	VREG1OUT x 0.89
5'h15	VREG1OUT x 0.90
5'h16	VREG1OUT x 0.91
5'h17	VREG1OUT x 0.92
5'h18	VREG1OUT x 0.93
5'h19	VREG1OUT x 0.94
5'h1A	VREG1OUT x 0.95
5'h1B	VREG1OUT x 0.96
5'h1C	VREG1OUT x 0.97
5'h1D	VREG1OUT x 0.98
5'h1E	VREG1OUT x 0.99
5'h1F	VREG1OUT x 1.00

VC1MSEL: VC1MSEL is to select VC1M1 or VC1M2; When VC1MSEL="0", VC1M1 is selected while VC1MSEL="1", VC1M2 is selected.

6.2.37. Window Horizontal RAM Address Start (R210h)

R/W	RS	CB15	CB14	CB13	CB12	CB11	CB10	CB9	CB8	CB7	CB6	CB5	CB4	CB3	CB2	CB1	CB0
W	1	0	0	0	0	0	0	0	0	HSA7 (0)	HSA6 (0)	HSA5 (0)	HSA4 (0)	HSA3 (0)	HSA2 (0)2	HSA1 (0)	HSA0 (0)

See R213h.

6.2.38. Window Horizontal RAM Address End (R211h)

R/W	RS	CB15	CB14	CB13	CB12	CB11	CB10	CB9	CB8	CB7	CB6	CB5	CB4	CB3	CB2	CB1	CB0
W	1	0	0	0	0	0	0	0	0	HEA7 (1)	HEA6 (1)	HEA5 (1)	HEA4 (1)	HEA3 (1)	HEA2 (1)	HEA1 (1)	HEA0 (1)

See R213h.

6.2.39. Window Vertical RAM Address Start (R212h)

R/W	RS	CB15	CB14	CB13	CB12	CB11	CB10	CB9	CB8	CB7	CB6	CB5	CB4	CB3	CB2	CB1	CB0
W	1	0	0	0	0	0	0	0	VSA8 (0)	VSA7 (0)	VSA6 (0)	VSA5 (0)	VSA4 (0)	VSA3 (0)	VSA2 (0)	VSA1 (0)	VSA0 (0)

See R213h.

6.2.40. Window Vertical RAM Address End (R213h)

R/W	RS	CB15	CB14	CB13	CB12	CB11	CB10	CB9	CB8	CB7	CB6	CB5	CB4	CB3	CB2	CB1	CB0
W	1	0	0	0	0	0	0	0	VEA8 (1)	VEA7 (1)	VEA6 (1)	VEA5 (1)	VEA4 (1)	VEA3 (1)	VEA2 (1)	VEA1 (1)	VEA0 (1)

HSA7-0/HEA7-0: OTM4001A provides window access function. Set HSA7-0 and HEA7-0 represent the start address and end address of the window function in horizontal direction. To use window-accessing function, HSA and HEA bits must be set before starting RAM write operation. Be aware that "00"h ≤ HSA7-0 < HEA7-0 ≤ "EF"h and HEA-HAS ≥ "04h".

VSA8-0/VEA8-0: OTM4001A provides window access function. Set VSA8-0 and VEA8-0 represent the start address and end address of the window in vertical direction. To use window-accessing function, VSA and VEA bits must be set before starting RAM write operation. Be aware that "00"h ≤ VSA8-0 < VEA8-0 ≤ 9'h1AF.

Figure 6-24 illustrates the window-accessing function.

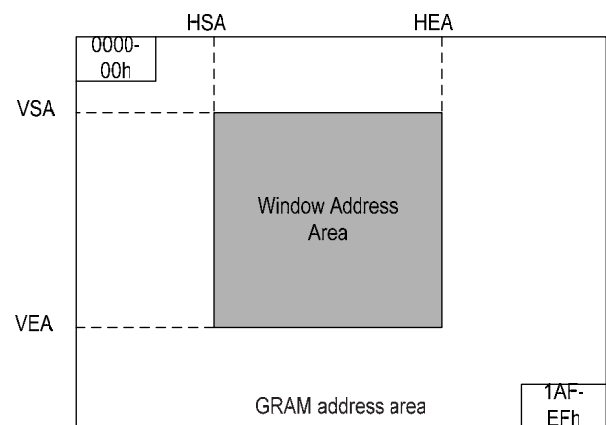

6.2.41. γ Control (R300h to R30Fh)

	R/W	RS	CB15	CB14	CB13	CB12	CB11	CB10	CB9	CB8	CB7	CB6	CB5	CB4	CB3	CB2	CB1	CB0
R300	W	1	0	0	0	V1RP4	V1RP3	V1RP2	V1RP1	V1RP0	0	0	0	V6RN4	V6RN3	V6RN2	V6RN1	V6RN0
R301	W	1	0	0	V2RP5	V2RP4	V2RP3	V2RP2	V2RP1	V2RP0	0	0	V5RN5	V5RN4	V5RN3	V5RN2	V5RN1	V5RN0
R302	W	1	0	0	V3RP5	V3RP4	V3RP3	V3RP2	V3RP1	V3RP0	0	0	V4RN5	V4RN4	V4RN3	V4RN2	V4RN1	V4RN0
R303	W	1	0	0	V4RP5	V4RP4	V4RP3	V4RP2	V4RP1	V4RP0	0	0	V3RN5	V3RN4	V3RN3	V3RN2	V3RN1	V3RN0
R304	W	1	0	0	V5RP5	V5RP4	V5RP3	V5RP2	V5RP1	V5RP0	0	0	V2RN5	V2RN4	V2RN3	V2RN2	V2RN1	V2RN0
R305	W	1	0	0	0	V6RP4	V6RP3	V6RP2	V6RP1	V6RP0	0	0	0	V1RN4	V1RN3	V1RN2	V1RN1	V1RN0
R306	W	1	0	0	0	V7RP4	V7RP3	V7RP2	V7RP1	V7RP0	0	0	0	V8RN4	V8RN3	V8RN2	V8RN1	V8RN0
R307	W	1	0	0	0	V8RP4	V8RP3	V8RP2	V8RP1	V8RP0	0	0	0	V7RN4	V7RN3	V7RN2	V7RN1	V7RN0
R308	W	1	0	0	0	0	V9RP3	V9RP2	V9RP1	V9RP0	0	0	0	0	V16RN3	V16RN2	V16RN1	V16RN0
R309	W	1	0	0	0	0	V10RP3	V10RP2	V10RP1	V10RP0	0	0	0	0	V15RN3	V15RN2	V15RN1	V15RN0
R30A	W	1	0	0	0	0	V11RP3	V11RP2	V11RP1	V11RP0	0	0	0	0	V14RN3	V14RN2	V14RN1	V14RN0
R30B	W	1	0	0	0	0	V12RP3	V12RP2	V12RP1	V12RP0	0	0	0	0	V13RN3	V13RN2	V13RN1	V13RN0
R30C	W	1	0	0	0	0	V13RP3	V13RP2	V13RP1	V13RP0	0	0	0	0	V12RN3	V12RN2	V12RN1	V12RN0
R30D	W	1	0	0	0	0	V14RP3	V14RP2	V14RP1	V14RP0	0	0	0	0	V11RN3	V11RN2	V11RN1	V11RN0
R30E	W	1	0	0	0	0	V15RP3	V15RP2	V15RP1	V15RP0	0	0	0	0	V10RN3	V10RN2	V10RN1	V10RN0
R30F	W	1	0	0	0	0	V16RP3	V16RP2	V16RP1	V16RP0	0	0	0	0	V9RN3	V9RN2	V9RN1	V9RN0

γ Control (R300h to R30Fh): OTM4001A provides 16 gamma registers to fine tune gamma output voltage.

V1RP[4:0]: register for positive VSD0 fine tune adjustment.
V2RP[5:0]: register for positive VSD1 fine tune adjustment.
V3RP[5:0]: register for positive VSD2 fine tune adjustment.
V4RP[5:0]: register for positive VSD61 fine tune adjustment.
V5RP[5:0]: register for positive VSD62 fine tune adjustment.
V6RP[4:0]: register for positive VSD63 fine tune adjustment.
V7RP[4:0]: register for positive VSD13 fine tune adjustment.
V8RP[4:0]: register for positive VSD50 fine tune adjustment.
V9RP[3:0]: register for positive VSD4 fine tune adjustment.
V10RP[3:0]: register for positive VSD8 fine tune adjustment.
V11RP[3:0]: register for positive VSD20 fine tune adjustment.
V12RP[3:0]: register for positive VSD27 fine tune adjustment.
V13RP[3:0]: register for positive VSD36 fine tune adjustment.
V14RP[3:0]: register for positive VSD43 fine tune adjustment.
V15RP[3:0]: register for positive VSD55 fine tune adjustment.
V16RP[3:0]: register for positive VSD59 fine tune adjustment.

V1RN[4:0]: register for negative VSD0 fine tune adjustment.
V2RN[5:0]: register for negative VSD1 fine tune adjustment.
V3RN[5:0]: register for negative VSD2 fine tune adjustment.
V4RN[5:0]: register for negative VSD61 fine tune adjustment.
V5RN[5:0]: register for negative VSD62 fine tune adjustment.
V6RN[4:0]: register for negative VSD63 fine tune adjustment.
V7RN[4:0]: register for negative VSD13 fine tune adjustment.
V8RN[4:0]: register for negative VSD50 fine tune adjustment.
V9RN[3:0]: register for negative VSD4 fine tune adjustment.
V10RN[3:0]: register for negative VSD8 fine tune adjustment.
V11RN[3:0]: register for negative VSD20 fine tune adjustment.
V12RN[3:0]: register for negative VSD27 fine tune adjustment.
V13RN[3:0]: register for negative VSD36 fine tune adjustment.
V14RN[3:0]: register for negative VSD43 fine tune adjustment.
V15RN[3:0]: register for negative VSD55 fine tune adjustment.
V16RN[3:0]: register for negative VSD59 fine tune adjustment.

6.2.42. Base Image Number of Line (R400h)

R/W	RS	CB15	CB14	CB13	CB12	CB11	CB10	CB9	CB8	CB7	CB6	CB5	CB4	CB3	CB2	CB1	CB0
W	1	GS (0)	0	NL5 (0)	NL4 (0)	NL3 (0)	NL2 (0)	NL1 (0)	NL0 (0)	0	0	SCN5 (0)	SCN4 (0)	SCN3 (0)	SCN2 (0)	SCN1 (0)	SCN0 (0)

SCN5-0: Set the SCN5-0 bits can specify the starting position of the gate driver. The start position of gate driver is determined by the combination of the setting of GS and SM. **Table 6-39** summarized the starting position for each SCN5-0 setting.

Table 6-39 (when SM=0)

SC N5	SC N4	SC N3	SC N2	SC N1	SC N0	Scan Start Position (Gate line)	
						GS = "0"	GS = "1"
0	0	0	0	0	0	G1	G432
0	0	0	0	0	1	G9	G424
0	0	0	0	1	0	G17	G416
0	0	0	0	1	1	G25	G408
0	0	0	1	0	0	G33	G400
0	0	0	1	0	1	G41	G392
0	0	0	1	1	0	G49	G384
0	0	0	1	1	1	G57	G376
0	0	1	0	0	0	G65	G368
0	0	1	0	0	1	G73	G360
0	0	1	0	1	0	G81	G352
0	0	1	0	1	1	G89	G344
0	0	1	1	0	0	G97	G336
0	0	1	1	0	1	G105	G328
0	0	1	1	1	0	G113	G320
0	0	1	1	1	1	G121	G312
0	1	0	0	0	0	G129	G304
0	1	0	0	0	1	G137	G296
0	1	0	0	1	0	G145	G288
0	1	0	0	1	1	G153	G280
0	1	0	1	0	0	G161	G272
0	1	0	1	0	1	G169	G264
0	1	0	1	1	0	G177	G256
0	1	0	1	1	1	G185	G248
0	1	1	0	0	0	G193	G240
0	1	1	0	0	1	G201	G232
0	1	1	0	1	0	G209	G224
0	1	1	0	1	1	G217	G216
0	1	1	1	0	0	G225	G208
0	1	1	1	0	1	G233	G200
0	1	1	1	1	0	G241	G192

SC N5	SC N4	SC N3	SC N2	SC N1	SC N0	Scan Start Position (Gate line)	
						GS = "0"	GS = "1"
0	1	1	1	1	1	G249	G184
1	0	0	0	0	0	G257	G176
1	0	0	0	0	1	G265	G168
1	0	0	0	1	0	G273	G160
1	0	0	0	1	1	G281	G152
1	0	0	1	0	0	G289	G144
1	0	0	1	0	1	G297	G136
1	0	0	1	1	0	G305	G128
1	0	0	1	1	1	G313	G120
1	0	1	0	0	0	G321	G112
1	0	1	0	0	1	G329	G104
1	0	1	0	1	0	G337	G96
1	0	1	0	1	1	G345	G88
1	0	1	1	0	0	G353	G80
1	0	1	1	0	1	G361	G72
1	0	1	1	1	0	G369	G64
1	0	1	1	1	1	G377	G56
1	1	0	0	0	0	G385	G48
1	1	0	0	0	1	G393	G40
1	1	0	0	1	0	G401	G32
1	1	0	0	1	1	G409	G24
1	1	0	1	0	0	G417	G16
1	1	0	1	0	1	G425	G8
1	1	0	1	1	0	Setting disabled	
Setting disabled							
1	1	1	1	1	1	Setting disabled	

Table 6-40 (when SM=1)

SC N5	SC N4	SC N3	SC N2	SC N1	SC N0	Scan Start Position (Gate line)	
						GS = "0"	GS = "1"
						0	0
0	0	0	0	0	1	G17	G416
0	0	0	0	1	0	G33	G400
0	0	0	0	1	1	G49	G384
0	0	0	1	0	0	G65	G368
0	0	0	1	0	1	G81	G352
0	0	0	1	1	0	G97	G336
0	0	0	1	1	1	G113	G320
0	0	1	0	0	0	G129	G304
0	0	1	0	0	1	G145	G288
0	0	1	0	1	0	G161	G272
0	0	1	0	1	1	G177	G256
0	0	1	1	0	0	G193	G240
0	0	1	1	0	1	G209	G224
0	0	1	1	1	0	G225	G208
0	0	1	1	1	1	G241	G192
0	1	0	0	0	0	G257	G176
0	1	0	0	0	1	G273	G160
0	1	0	0	1	0	G289	G144
0	1	0	0	1	1	G305	G128
0	1	0	1	0	0	G321	G112
0	1	0	1	0	1	G337	G96
0	1	0	1	1	0	G353	G80
0	1	0	1	1	1	G369	G64
0	1	1	0	0	0	G385	G48
0	1	1	0	0	1	G401	G32
0	1	1	0	1	0	G417	G16
0	1	1	0	1	1	G2	G431
0	1	1	1	0	0	G18	G415
0	1	1	1	0	1	G34	G399
0	1	1	1	1	0	G50	G383

SC N5	SC N4	SC N3	SC N2	SC N1	SC N0	Scan Start Position (Gate line)	
						GS = "0"	GS = "1"
						0	1
1	0	0	0	0	0	G82	G351
1	0	0	0	0	1	G98	G335
1	0	0	0	1	0	G114	G319
1	0	0	0	1	1	G130	G303
1	0	0	1	0	0	G146	G287
1	0	0	1	0	1	G162	G271
1	0	0	1	1	0	G178	G255
1	0	0	1	1	1	G194	G239
1	0	1	0	0	0	G210	G223
1	0	1	0	0	1	G226	G207
1	0	1	0	1	0	G242	G191
1	0	1	0	1	1	G258	G175
1	0	1	1	0	0	G274	G159
1	0	1	1	0	1	G290	G143
1	0	1	1	1	0	G306	G127
1	0	1	1	1	1	G322	G111
1	1	0	0	0	0	G338	G95
1	1	0	0	0	1	G354	G79
1	1	0	0	1	0	G370	G63
1	1	0	0	1	1	G386	G47
1	1	0	1	0	0	G402	G31
1	1	0	1	0	1	G418	G15
1	1	0	1	1	0	Setting disabled	
Setting disabled							
1	1	1	1	1	1		

NL5-0: Set the number of gate lines for different resolution of display panel. The combination of NL5-NL0 represents the gate line number are summarized at **Table 6-41**.

Table 6-41

NL5	NL4	NL3	NL2	NL1	NL0	Display Size	No. of Lines	Driven gate lines
0	0	0	0	0	0	Setting disabled	Setting disabled	Setting disabled
0	0	0	0	0	1	720 x 16 dots	16	G1 ~ G16
0	0	0	0	1	0	720 x 24 dots	24	G1 ~ G24
0	0	0	0	1	1	720 x 32 dots	32	G1 ~ G32
0	0	0	1	0	0	720 x 40 dots	40	G1 ~ G40
0	0	0	1	0	1	720 x 48 dots	48	G1 ~ G48
0	0	0	1	1	0	720 x 56 dots	56	G1 ~ G56
0	0	0	1	1	1	720 x 64 dots	64	G1 ~ G64
0	0	1	0	0	0	720 x 72 dots	72	G1 ~ G72
0	0	1	0	0	1	720 x 80 dots	80	G1 ~ G80
0	0	1	0	1	0	720 x 88 dots	88	G1 ~ G88
0	0	1	0	1	1	720 x 96 dots	96	G1 ~ G96
0	0	1	1	0	0	720 x 104 dots	104	G1 ~ G104
0	0	1	1	0	1	720 x 112 dots	112	G1 ~ 112
0	0	1	1	1	0	720 x 120 dots	120	G1 ~ 120
0	0	1	1	1	1	720 x 128 dots	128	G1 ~ 128
0	1	0	0	0	0	720 x 136 dots	136	G1 ~ 136
0	1	0	0	0	1	720 x 144 dots	144	G1 ~ 144
0	1	0	0	1	0	720 x 152 dots	152	G1 ~ 152
0	1	0	0	1	1	720 x 160 dots	160	G1 ~ 160
0	1	0	1	0	0	720 x 168 dots	168	G1 ~ 168
0	1	0	1	0	1	720 x 176 dots	176	G1 ~ 176
0	1	0	1	1	0	720 x 184 dots	184	G1 ~ 184
0	1	0	1	1	1	720 x 192 dots	192	G1 ~ 192
0	1	1	0	0	0	720 x 200 dots	200	G1 ~ 200
0	1	1	0	0	1	720 x 208 dots	208	G1 ~ 208
0	1	1	0	1	0	720 x 216 dots	216	G1 ~ 216
0	1	1	0	1	1	720 x 224 dots	224	G1 ~ 224
0	1	1	1	0	0	720 x 232 dots	232	G1 ~ 232
0	1	1	1	0	1	720 x 240 dots	240	G1 ~ 240
0	1	1	1	1	0	720 x 248 dots	248	G1 ~ 248
0	1	1	1	1	1	720 x 256 dots	256	G1 ~ 256
1	0	0	0	0	0	720 x 264 dots	264	G1 ~ 264
1	0	0	0	0	1	720 x 272 dots	272	G1 ~ 272
1	0	0	0	1	0	720 x 280 dots	280	G1 ~ 280
1	0	0	0	1	1	720 x 288 dots	288	G1 ~ 288
1	0	0	1	0	0	720 x 296 dots	296	G1 ~ 296
1	0	0	1	0	1	720 x 304 dots	304	G1 ~ 304
1	0	0	1	1	0	720 x 312 dots	312	G1 ~ 312
1	0	0	1	1	1	720 x 320 dots	320	G1 ~ 320
1	0	1	0	0	0	720 x 328 dots	328	G1 ~ 328

NL5	NL4	NL3	NL2	NL1	NL0	Display Size	No. of Lines	Driven gate lines
1	0	1	0	0	1	720 x 336 dots	336	G1 ~ 336
1	0	1	0	1	0	720 x 344 dots	344	G1 ~ 344
1	0	1	0	1	1	720 x 352 dots	352	G1 ~ 352
1	0	1	1	0	0	720 x 360 dots	360	G1 ~ 360
1	0	1	1	0	1	720 x 368 dots	368	G1 ~ 368
1	0	1	1	1	0	720 x 376 dots	376	G1 ~ 376
1	0	1	1	1	1	720 x 384 dots	384	G1 ~ 384
1	1	0	0	0	0	720 x 392 dots	392	G1 ~ 392
1	1	0	0	0	1	720 x 400 dots	400	G1 ~ 400
1	1	0	0	1	0	720 x 408 dots	408	G1 ~ 408
1	1	0	0	1	1	720 x 416 dots	416	G1 ~ 416
1	1	0	1	0	0	720 x 424 dots	424	G1 ~ 424
1	1	0	1	0	1	720 x 432 dots	432	G1 ~ 432
Setting Disabled								

Note: Back porch and a front porch (set with BP/FP bits respectively) are inserted before/ after driving all gate lines.

GS: Shift direction of the gate driver output selection. When

GS="0", gate driver shift from G1 to G432. When GS = "1", gate driver shift from G432 to G1.

6.2.43. Base Image Display Control (R401h)

R/W	RS	CB15	CB14	CB13	CB12	CB11	CB10	CB9	CB8	CB7	CB6	CB5	CB4	CB3	CB2	CB1	CB0	
W	1	0	0	0	0	0	0	0	0	0	0	0	0	0	0	NDL	VLE	REV
																(0)	(0)	(0)

REV: To set the grayscale corresponding to normally white or normally black LCD panel from same data input. **Table 6-42** summarized REV bit function.

Table 6-42

REV	GRAM data	Source Driver Output	
		Positive Polarity	Negative Polarity
0	18'h00000	V63	V0
	18'h3FFFF	V0	V63
1	18'h00000	V0	V63
	18'h3FFFF	V63	V0

VLE: OTM4001A provides vertical scrolling function which can be set by VLE bit.

VLE = "1", vertical scrolling function enable. The amount of scrolling line from the first line is determined by VL[8:0].

VLE = "0", normal display.

NDL: set the source driver output level in non-lit area..

NDL = "1", Positive = V0, Negative = V31;

NDL = "0", Positive = V31 and Negative = V0.

6.2.44. Based Image Vertical Scroll Control (R404h)

R/W	RS	CB15	CB14	CB13	CB12	CB11	CB10	CB9	CB8	CB7	CB6	CB5	CB4	CB3	CB2	CB1	CB0
W	1	0	0	0	0	0	0	0	VL8 (0)	VL7 (0)	VL6 (0)	VL5 (0)	VL4 (0)	VL3 (0)	VL2 (0)	VL1 (0)	VL0 (0)

VL8-0: OTM4001A provides scrolling function. The start position for displaying the image is shifted vertically by the number of lines based on the setting of the VL8-0 bits. Be aware that the vertical scrolling function is not available in the external (RGB) display interface mode. **Table 6-43** summarized the function of VL8-0 setting.

Table 6-43

VL8	VL7	VL6	VL5	VL4	VL3	VL2	VL1	VL0	Scrolling lines
0	0	0	0	0	0	0	0	0	0 line
0	0	0	0	0	0	0	0	1	1 line
0	0	0	0	0	0	0	1	0	2 lines
	:	:	:	:	:	:	:	:	:
1	1	0	1	0	1	1	1	0	431 lines
1	1	0	1	0	1	1	1	1	432 lines

Note: VL8-0 bits cannot set more than 432 lines.

6.2.45. Display Position - Partial Display 1 (R500h)

R/W	RS	CB15	CB14	CB13	CB12	CB11	CB10	CB9	CB8	CB7	CB6	CB5	CB4	CB3	CB2	CB1	CB0
W	1	0	0	0	0	0	0	0	PTD P08	PTD P07	PTD P06	PTD P05	PTD P04	PTD P03	PTD P02	PTD P01	PTD P00

See R505h.

6.2.46. RAM Address Start – Partial Display 1 (R501h)

R/W	RS	CB15	CB14	CB13	CB12	CB11	CB10	CB9	CB8	CB7	CB6	CB5	CB4	CB3	CB2	CB1	CB0
W	1	0	0	0	0	0	0	0	PTS A08	PTS A07	PTS A06	PTS A05	PTS A04	PTS A03	PTS A02	PTS A01	PTS A00

See R505h.

6.2.47. RAM Address End – Partail Display 1 (R502h)

R/W	RS	CB15	CB14	CB13	CB12	CB11	CB10	CB9	CB8	CB7	CB6	CB5	CB4	CB3	CB2	CB1	CB0
W	1	0	0	0	0	0	0	0	PTE A08	PTE A07	PTE A06	PTE A05	PTE A04	PTE A03	PTE A02	PTE A01	PTE A00

See R505h.

6.2.48. Display Position – Partial Display 2 (R503h)

R/W	RS	CB15	CB14	CB13	CB12	CB11	CB10	CB9	CB8	CB7	CB6	CB5	CB4	CB3	CB2	CB1	CB0
W	1	0	0	0	0	0	0	0	PTD P18	PTD P17	PTD P16	PTD P15	PTD P14	PTD P13	PTD P12	PTD P11	PTD P10

See R505h.

6.2.49. RAM Address Start – Partial Display 2 (R504h)

R/W	RS	CB15	CB14	CB13	CB12	CB11	CB10	CB9	CB8	CB7	CB6	CB5	CB4	CB3	CB2	CB1	CB0
W	1	0	0	0	0	0	0	0	PTS A18	PTS A17	PTS A16	PTS A15	PTS A14	PTS A13	PTS A12	PTS A11	PTS A10

See R505h.

6.2.50. RAM Address End – Partial Display 2 (R505h)

R/W	RS	CB15	CB14	CB13	CB12	CB11	CB10	CB9	CB8	CB7	CB6	CB5	CB4	CB3	CB2	CB1	CB0
W	1	0	0	0	0	0	0	0	PTE A18	PTE A17	PTE A16	PTE A15	PTE A14	PTE A13	PTE A12	PTE A11	PTE A10

PTDP0[8:0]: Set the physical starting position of partial display 1 on the LCD panel

PTDP1[8:0]: Set the physical starting position of partial display 2 on the LCD panel

The partial display 1 and partial display 2 should not overlap with each other. And make sure the PTDP0[8:0] < PTDP1[8:0].

PTSA0[8:0]: Set the start line address of display RAM of partial display 1 which will be display according to PTDP0[8:0].

PTEA0[8:0]: Set the end line address of display RAM of partial display 1 which will be display according to PTDP0[8:0].

Make sure PTSA0 ≤ PTEA0.

PTSA1[8:0]: Set the start line address of display RAM of partial display2 which will be display according to PTDP1[8:0].

PTEA1[8:0]: Set the end line address of display RAM of partial display2 which will be display according to PTDP1[8:0]

Make sure PTSA1 ≤ PTEA1.

6.2.51. CABC Gamma RAM Bank Selection (R601h)

R/W	RS	CB15	CB14	CB13	CB12	CB11	CB10	CB9	CB8	CB7	CB6	CB5	CB4	CB3	CB2	CB1	CB0
W	1	0	0	0	0	0	0	0	0	0	0	0	0	0	CABC_	CABC_	CABC_
															BANK2	BANK1	BANK0

CABC_BANK[2:0] : Select which bank is selected to read data out.

6.2.52. CABC Gamma RAM Bank Write (R602h)

R/W	RS	CB15	CB14	CB13	CB12	CB11	CB10	CB9	CB8	CB7	CB6	CB5	CB4	CB3	CB2	CB1	CB0
W	1	CABC RAM Write Command															

Start to write the cabc gamma data to cabc gamma ram.

6.2.53. CABC Gamma RAM Bank Read (R603h)

R/W	RS	CB15	CB14	CB13	CB12	CB11	CB10	CB9	CB8	CB7	CB6	CB5	CB4	CB3	CB2	CB1	CB0
W	1	CABC RAM Read Command															

Start to Read the cabc gamma data to cabc gamma ram.

6.2.54. Pin Control (R606h)

R/W	RS	CB15	CB14	CB13	CB12	CB11	CB10	CB9	CB8	CB7	CB6	CB5	CB4	CB3	CB2	CB1	CB0
W	1	0	0	0	0	0	0	0	TCREV 1(0)	0	0	0	0	0	0	0	TCREV 0(0)

TCREV1-0: Set the order of receiving data when using i80 interface.

TCREV1-0	2 Transfers/Pixel	3 Transfers/Pixel
00	1st to 2nd	1st to 3rd
01 – 10	Setting Disabled	
11	2nd to 1st	3rd to 1st

Note 1: During read operation, the setting of TCREV is ignored; data is transferred from 1st to 2nd/1st to 3rd.

Note 2: Reset TCREV after reset and power-on.

ORISE Tech Confidential
For Honshine Use Only

7. GRAM
Table 7-1 GRAM address and display panel position (SS = "0")

S/G pin		S1	S2	S3	S4	S5	S6	S7	S8	S9	S10	S11	S12	...	S709	S710	S711	S712	S713	S714	S715	S716	S717	S718	S719	S720
GS=0	GS=1	DB17-0			DB17-0			DB17-0			DB17-0			DB17-0			DB17-0			DB17-0			DB17-0		
G1	G400	"00000"H	"00001"H	"00002"H	"00003"H	...	"000EC"H	"000ED"H	"000EE"H	"000EF"H																
G2	G399	"00100"H	"00101"H	"00102"H	"00103"H	...	"001EC"H	"001ED"H	"001EE"H	"001EF"H																
G3	G398	"00200"H	"00201"H	"00202"H	"00203"H	...	"002EC"H	"002ED"H	"002EE"H	"002EF"H																
G4	G397	"00300"H	"00301"H	"00302"H	"00303"H	...	"003EC"H	"003ED"H	"003EE"H	"003EF"H																
G5	G396	"00400"H	"00401"H	"00402"H	"00403"H	...	"004EC"H	"004ED"H	"004EE"H	"004EF"H																
G6	G395	"00500"H	"00501"H	"00502"H	"00503"H	...	"005EC"H	"005ED"H	"005EE"H	"005EF"H																
G7	G394	"00600"H	"00601"H	"00602"H	"00603"H	...	"006EC"H	"006ED"H	"006EE"H	"006EF"H																
G8	G393	"00700"H	"00701"H	"00702"H	"00703"H	...	"007EC"H	"007ED"H	"007EE"H	"007EF"H																
G9	G392	"00800"H	"00801"H	"00802"H	"00803"H	...	"008EC"H	"008ED"H	"008EE"H	"008EF"H																
G10	G391	"00900"H	"00901"H	"00902"H	"00903"H	...	"009EC"H	"009ED"H	"009EE"H	"009EF"H																
G11	G390	"00E00"H	"00E01"H	"00E02"H	"00E03"H	...	"00EEC"H	"00EED"H	"00EEE"H	"00EEF"H																
G12	G389	"00B00"H	"00B01"H	"00B02"H	"00B03"H	...	"00BEC"H	"00BED"H	"00BEE"H	"00BEF"H																
G13	G388	"00C00"H	"00C01"H	"00C02"H	"00C03"H	...	"00CEC"H	"00CED"H	"00CEE"H	"00CEF"H																
G14	G387	"00D00"H	"00D01"H	"00D02"H	"00D03"H	...	"00DEC"H	"00DED"H	"00DEE"H	"00DEF"H																
G15	G386	"00E00"H	"00E01"H	"00E02"H	"00E03"H	...	"00EEC"H	"00EED"H	"00EEE"H	"00EEF"H																
G16	G385	"00F00"H	"00F01"H	"00F02"H	"00F03"H	...	"00FEC"H	"00FED"H	"00FEE"H	"00FEF"H																
G17	G384	"01000"H	"01001"H	"01002"H	"01003"H	...	"010EC"H	"010ED"H	"010EE"H	"010EF"H																
G18	G383	"01100"H	"01101"H	"01102"H	"01103"H	...	"011EC"H	"011ED"H	"011EE"H	"011EF"H																
G19	G382	"01200"H	"01201"H	"01202"H	"01203"H	...	"012EC"H	"012ED"H	"012EE"H	"012EF"H																
G20	G381	"01300"H	"01301"H	"01302"H	"01303"H	...	"013EC"H	"013ED"H	"013EE"H	"013EF"H																
:	:	:	:	:	:	:	:	:	:	:																
:	:	:	:	:	:	:	:	:	:	:																
G393	G8	"1A900"H	"1A801"H	"1A802"H	"1A803"H	...	"1A8EC"H	"1A8ED"H	"1A8EE"H	"1A8EF"H																
G394	G7	"1AA00"H	"1A901"H	"1A902"H	"1A903"H	...	"1A9EC"H	"1A9ED"H	"1A9EE"H	"1A9EF"H																
G395	G6	"1AB00"H	"1AA01"H	"1AA02"H	"1AA03"H	...	"1AAEC"H	"1AAED"H	"1AAEE"H	"1AAEF"H																
G396	G5	"1AC00"H	"1AB01"H	"1AB02"H	"1AB03"H	...	"1ABEC"H	"1ABED"H	"1ABEE"H	"1ABEF"H																
G397	G4	"1AD00"H	"1AC01"H	"1AC02"H	"1AC03"H	...	"1ACEC"H	"1ACED"H	"1ACEE"H	"1ACEF"H																
G398	G3	"1AD00"H	"1AD01"H	"1AD02"H	"1AD03"H	...	"1ADEC"H	"1ADED"H	"1ADEE"H	"1ADEF"H																
G399	G2	"1AE00"H	"1AE01"H	"1AE02"H	"1AE03"H	...	"1AEEC"H	"1AEED"H	"1AEEE"H	"1AEEF"H																
G400	G1	"1AF00"H	"1AF01"H	"1AF02"H	"1AF03"H	...	"1AFEC"H	"1AFED"H	"1AFEE"H	"1AFEF"H																

Table 7-2 GRAM address and display panel position (SS = "1")

S/G pin		S1	S2	S3	S4	S5	...	S7	S8	S9	S10	S11	S12	...	S709	S710	S711	S712	S713	S714	S715	S716	S717	S718	S719	S720
GS=0	GS=1	DB17-0			DB17-0			DB17-0			DB17-0			...	DB17-0			DB17-0			DB17-0			DB17-0		
G1	G432	"000EF"H			"000EE"H			"000ED"H			"000EC"H			...	"00003"H			"00002"H			"00001"H			"00000"H		
G2	G431	"001EF"H			"001EE"H			"001ED"H			"001EC"H			...	"00103"H			"00102"H			"00101"H			"00100"H		
G3	G430	"002EF"H			"002AE"H			"002ED"H			"002EC"H			...	"00203"H			"00202"H			"00201"H			"00200"H		
G4	G429	"003EF"H			"003EE"H			"003ED"H			"003EC"H			...	"00303"H			"00302"H			"00301"H			"00300"H		
G5	G428	"004EF"H			"004EE"H			"004ED"H			"004EC"H			...	"00403"H			"00402"H			"00401"H			"00400"H		
G6	G427	"005EF"H			"005EE"H			"005ED"H			"005EC"H			...	"00503"H			"00502"H			"00501"H			"00500"H		
G7	G426	"006EF"H			"006EE"H			"006ED"H			"006EC"H			...	"00603"H			"00602"H			"00601"H			"00600"H		
G8	G425	"007EF"H			"007EE"H			"007ED"H			"007EC"H			...	"00703"H			"00702"H			"00701"H			"00700"H		
G9	G424	"008EF"H			"008EE"H			"008ED"H			"008EC"H			...	"00803"H			"00802"H			"00801"H			"00800"H		
G10	G423	"009EF"H			"009EE"H			"009ED"H			"009EC"H			...	"00903"H			"00902"H			"00901"H			"00900"H		
G11	G422	"00AEF"H			"00AEE"H			"00AED"H			"00AEC"H			...	"00E03"H			"00A02"H			"00A01"H			"00A00"H		
G12	G421	"00BEF"H			"00BEE"H			"00BED"H			"00BEC"H			...	"00B03"H			"00B02"H			"00B01"H			"00B00"H		
G13	G420	"00CEF"H			"00CEE"H			"00CED"H			"00CEC"H			...	"00C03"H			"00C02"H			"00C01"H			"00C00"H		
G14	G419	"00DEF"H			"00DEE"H			"00DED"H			"00DEC"H			...	"00D03"H			"00D02"H			"00D01"H			"00D00"H		
G15	G418	"00EEF"H			"00EEE"H			"00EED"H			"00EEC"H			...	"00E03"H			"00E02"H			"00E01"H			"00E00"H		
G16	G417	"00FEF"H			"00FEE"H			"00FED"H			"00FEC"H			...	"00F03"H			"00F02"H			"00F01"H			"00F00"H		
G17	G416	"010EF"H			"010EE"H			"010ED"H			"010EC"H			...	"01003"H			"01002"H			"01001"H			"01000"H		
G18	G415	"011EF"H			"011EE"H			"011ED"H			"011EC"H			...	"01103"H			"01102"H			"01101"H			"01100"H		
G19	G414	"012EF"H			"012EE"H			"012ED"H			"012EC"H			...	"01203"H			"01202"H			"01201"H			"01200"H		
G20	G413	"013EF"H			"013EE"H			"013ED"H			"013EC"H			...	"01303"H			"01302"H			"01301"H			"01300"H		
:	:	:	:	:	:	:	:	:	:	:	:	:	:	:	:	:	:	:	:	:	:	:	:	:	:	:
:	:	:	:	:	:	:	:	:	:	:	:	:	:	:	:	:	:	:	:	:	:	:	:	:	:	:
G425	G8	"1A8EF"H			"1A8EE"H			"1A8ED"H			"1A8EC"H			...	"1A803"H			"1A802"H			"1A801"H			"1A900"H		
G426	G7	"1A9EF"H			"1A9EE"H			"1A9ED"H			"1A9EC"H			...	"1A903"H			"1A902"H			"1A901"H			"1AA00"H		
G427	G6	"1AAEF"H			"1AAEE"H			"1AAED"H			"1AAEC"H			...	"1AA03"H			"1AA02"H			"1AA01"H			"1AB00"H		
G428	G5	"1ABEF"H			"1ABEE"H			"1ABED"H			"1ABEC"H			...	"1AB03"H			"1AB02"H			"1AB01"H			"1AC00"H		
G429	G4	"1ACEF"H			"1ACEE"H			"1ACED"H			"1ACEC"H			...	"1AC03"H			"1AC02"H			"1AC01"H			"1AD00"H		
G430	G3	"1ADEF"H			"1ADEE"H			"1ADED"H			"1ADEC"H			...	"1AD03"H			"1AD02"H			"1AD01"H			"1AD00"H		
G431	G2	"1AEEF"H			"1AEEE"H			"1AEED"H			"1AEEC"H			...	"1AE03"H			"1AE02"H			"1AE01"H			"1AE00"H		
G432	G1	"1AFEF"H			"1AFEE"H			"1AFED"H			"1AFEC"H			...	"1AF03"H			"1AF02"H			"1AF01"H			"1AF00"H		

8. INTERFACES

The OTM4001A provides different interfaces to meet the diverse need of small/medium size LCD. Based on the application requirement, there are three different display modes which are most used in end product.

1. Still picture display
2. Moving picture display.
3. Re-writing still pictures while moving picture are display.

For above three different display requirements, OTM4001A provides different interfaces to meet the requirement.

1. System interface
2. External interface (RGB interface)
3. VSYNC interface

System interface is suitable for still picture display while RGB interface and VSYNC interface are suitable for moving picture display. Be aware that RGB or VSYNC interface still can used to display still picture and system interface can also display moving picture. **Table 8-1** summarized different interfaces for different display requirement.

Table 8-1

Operation Mode	Display Mode	RAM Access Setting (RM)	Display Operation Mode (DM1-0)
System	Still picture	System interface (RM = 0)	Internal operating clock (DM1-0 = 00)
RGB interface (1)	Moving picture	RGB interface (RM = 1)	RGB interface (DM1-0 = 01)
RGB interface (2)	Rewriting still pictures while displaying moving pictures	System interface (RM = 0)	RGB interface (DM1-0 = 01)
VSYNC interface	Moving pictures	System interface (RM = 0)	VSYNC interface (DM1-0 = 10)

8.1. System Interface

The system interfaces of OTM4001A can support 8-bit, 9-bit, 16-bit, 18-bit 80-system Interface and Serial Peripheral Interface (SPI), which can be set by the IM2/1/0 pins. The system interface can set

instructions and access RAM. **Table 8-2** summarized the interface corresponding to IM2-0 setting.

Table 8-2

IM2	IM1	IM0	MPU-Interface Mode	DB Pin in use
0	0	0	80-system 18-bit interface	DB17 to 0
0	0	1	80-system 9-bit interface	DB17 to 9
0	1	0	80-system 16-bit interface	DB17 to 10 and 8 to 1
0	1	1	80-system 8-bit interface	DB17 to 10
1	0	*	Serial peripheral interface (SPI)	DB1 to 0
1	1	0	Setting disabled	-
1	1	1	Setting disabled	-

8.1.1. 80-system 18-bit interface

The instruction and GRAM accessing format of 80-system 18-bit interface are shown in **Figure 8-1** and **Figure 8-2**, respectively.

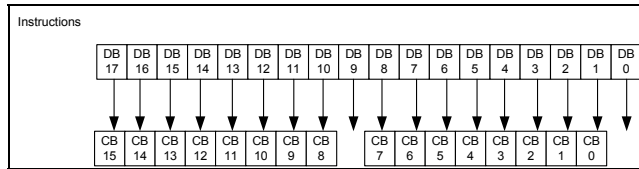

Figure 8-1

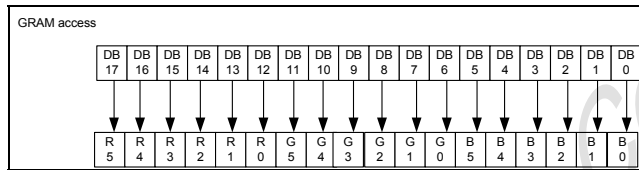

Figure 8-2

8.1.2. 80-system 16-bit interface

The instruction and GRAM accessing format of 80-system 16-bit interface are shown in **Figure 8-3** and **Figure 8-4**, respectively.

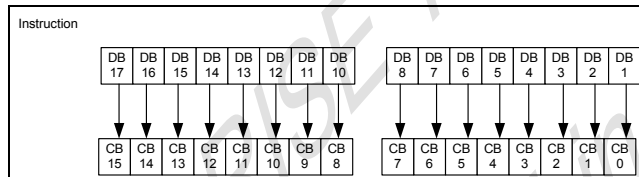

Figure 8-3

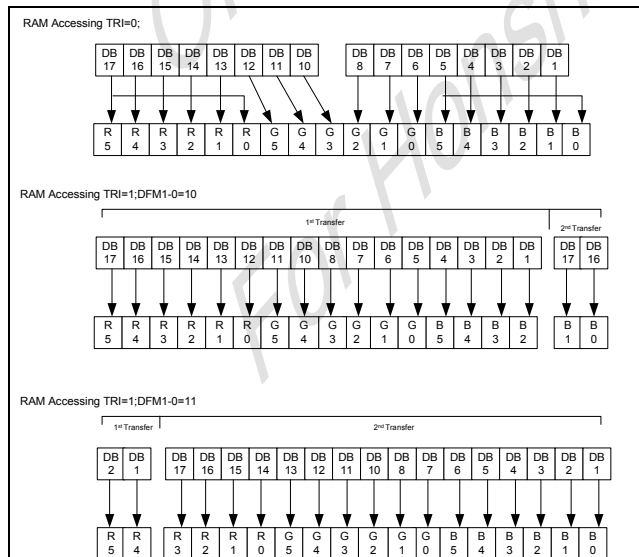

Figure 8-4

8.1.3. 80-system 9-bit interface

The instruction and GRAM accessing format of 80-system 9-bit interface are shown in **Figure 8-5** and **Figure 8-6**, respectively.

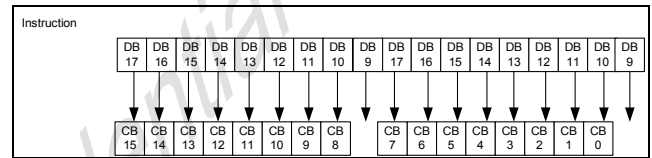

Figure 8-5

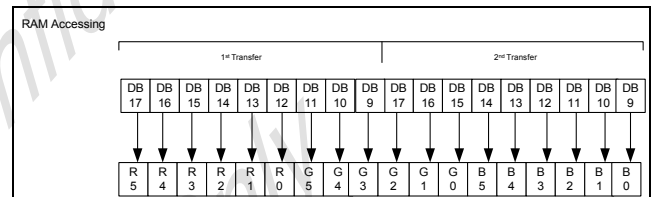

Figure 8-6

8.1.4. 80-system 8-bit interface

The instruction and GRAM accessing format of 80-system 8-bit interface are shown in **Figure 8-7** and **Figure 8-8**, respectively.

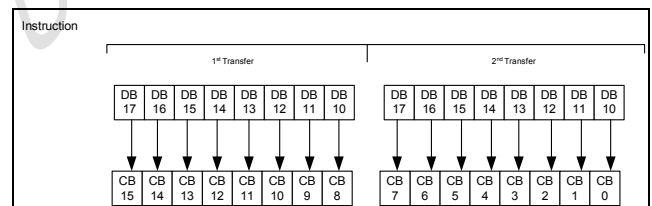

Figure 8-7

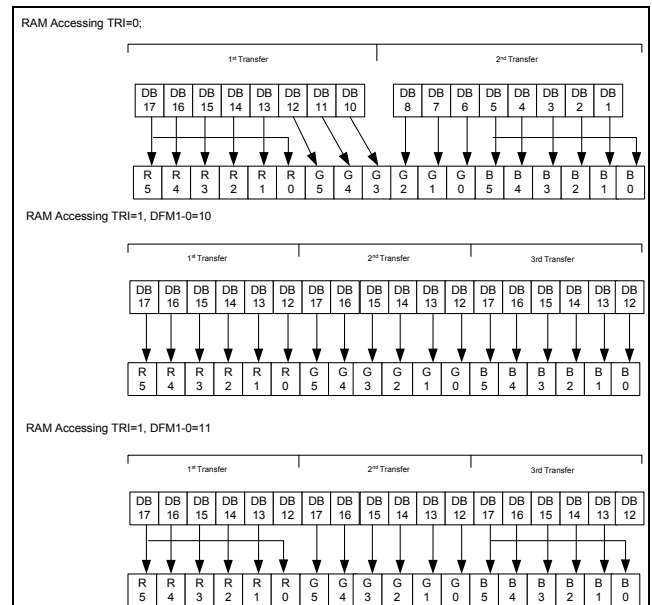

Figure 8-8

8.1.5. Serial Peripheral interface (SPI)

The system interface of OTM4001A also includes the Serial Peripheral Interface (SPI). In SPI mode, /CS, SCL, SDI and SDO are used to transfer data between MCU and OTM4001A. IM0/ID pin served as the ID pin. **Figure 8-9** illustrates the detail timing while using SPI. Be aware that the unused pins such as DB17-0 pins must be fixed at either IOVCC or GND level.

The instruction and GRAM accessing format of SPI interface are shown in **Figure 8-10** and **Figure 8-11**, respectively.

When read operation is desired In SPI mode, valid data are read out as the OTM4001A reads out the 6th byte data from the internal GRAM. The RAM data transfer in SPI mode, in SPI mode with TRI=1/ DFM1-0=10 and status read are illustrated in **Figure 8-12**, **Figure 8-13** and **Figure 8-14**, respectively.

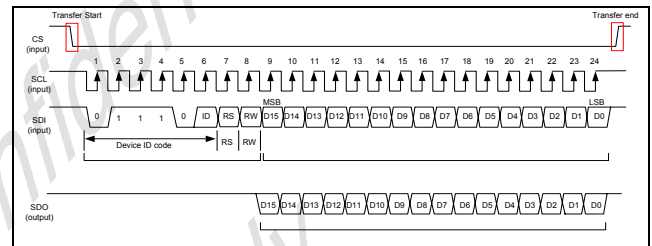

Figure 8-9

Start Byte Format

Transferred bits	S	1	2	3	4	5	6	7	8	
Start byte format	Transfer start	Device ID code					RS	R/W		
		0	1	1	1	0	ID			

Note 1) ID bit is selected by setting the IM0/ID pin.

RS	R/W	Function
0	0	Set an index register
0	1	Read a status
1	0	Write an instruction or RAM data
1	1	Read an instruction or RAM data

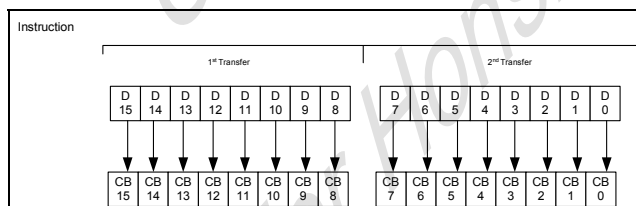

Figure 8-10

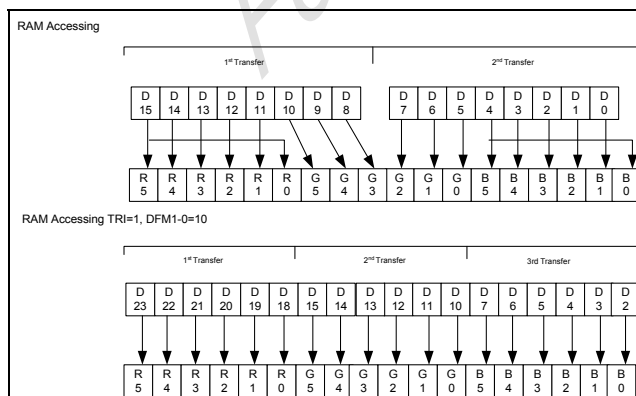

Figure 8-11

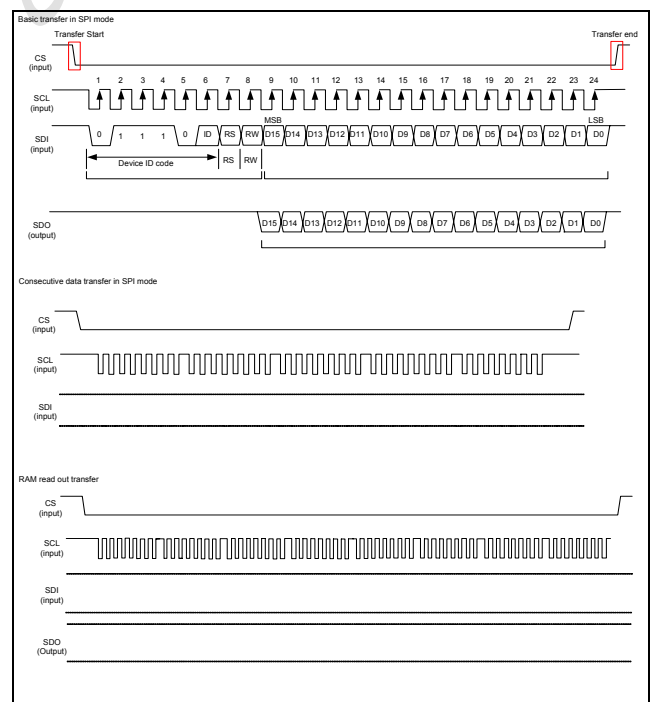

Figure 8-12

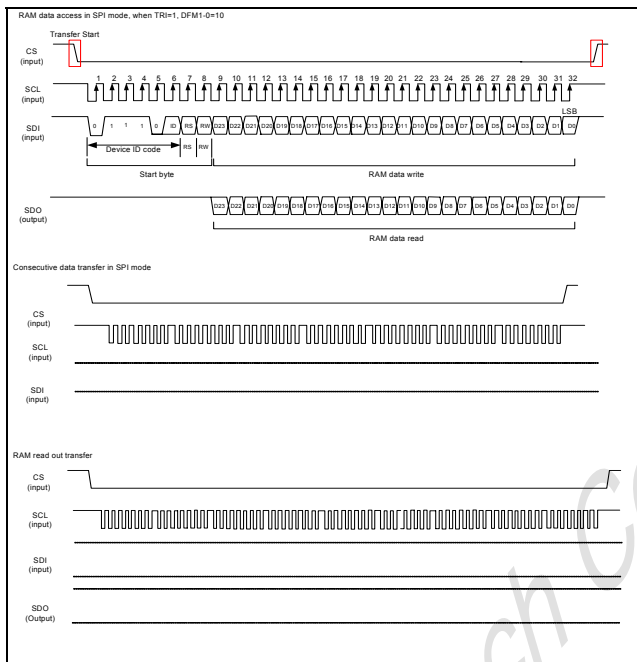

Figure 8-13

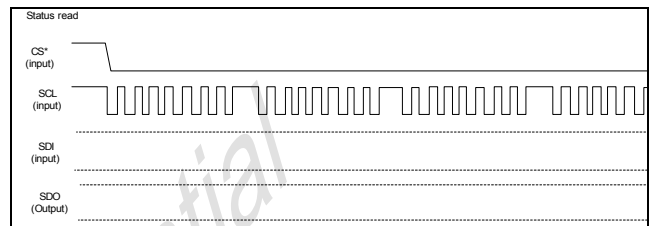

Figure 8-14

8.2. VSYNC Interface

The OTM4001A also supports VSYNC interface for moving picture display, which is the system interface in synchronization with the frame-synchronizing signal (VSYNC). The VSYNC interface can display a moving picture without tremendous modification.

DM1-0 = "10" and RM = "0" can initialize VSYNC interface. In VSYNC interface mode, the internal display operation is synchronized with the VSYNC signal. In VSYNC interface mode, the graphic data are stored in GRAM to minimize the data transfer to overwrite on the moving picture GRAM area. **Figure 8-15** illustrates moving picture data transfer through VSYNC interface.

In VSYNC mode, Internal operation is executed in synchronization with the internal clock generated from internal oscillators and VSYNC input. Therefore the frame rate is determined by the frequency of VSYNC. OTM4001A can access the internal RAM in high speed with less power consumption in VSYNC interface mode while using high-speed write mode

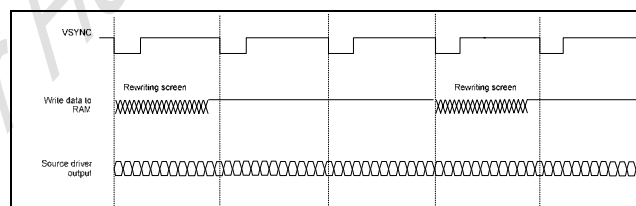

Figure 8-15

In VSYNC interface mode, the formula for Internal clock frequency and frame rate is shown below:

$$\text{Input clock frequency} = \text{FrameRate} \times (\text{DisplayLines} + \text{FrontPorch} + \text{BackPorch}) \times 16 \times \text{variance}$$

Due to the possible cause of variances while set the internal clock frequency; be sure to complete the display operation in one VSYNC cycle.

8.3. External Display Interface

OTM4001A also includes external (RGB) interface for displaying moving picture. External interface can be set by RIM1-0 bit. **Table 8-3** summarized the corresponding types of RGB interface with RM1-0 setting.

Table 8-3

RIM1	RIM0	RGB Interface	DB Pin
0	0	18-bit RGB interface	DB17-0
0	1	16-bit RGB interface	DB17-13, 11-1
1	0	6-bit RGB interface	DB17-12
1	1	Setting disabled	

RGB interface can access OTM4001A by VSYNC, HSYNC, ENABLE, DOTCLK and DB17-0 signals, where VSYNC is used for frame synchronization; HSYNC is used for line synchronization and ENABLE is served as the valid data synchronized signals. The RGB interface can be rewriting minimum necessary data to the GRAM area which need to be overwritten with use of window address function and high-speed write mode. It is necessary for RGB interface to set front and back porch periods after and before a display period, respectively. **Figure 8-16** illustrates the general timing for RGB interface. There are some constrain while using RGB interface. The following summarized the conditions,

- Partial display/ scroll function / interface and graphics operation function are not available for RGB interface.
- In RGB interface VSYNC, HSYNC, and DOTCLK signals must be input through a display operation period.
- The setting of the NO1-0 bits, STD1-0 bits and EQ1-0 bits are based on DOTCLK in RGB interface mode. In 6-bit RGB interface mode, it takes 3 DOTCLK inputs to transfer one pixel. Be aware data transfer in units of 3 DOTCLK inputs in 6-bit RGB interface mode is necessary. Set the cycle of each signal in 6-bit interface mode (VSYNC, HSYNC, ENABLE, DB17-0) to input 3x clock to complete data transfer in units of pixels.
- In RGB-I/F mode, while writing data to the internal RAM make sure to use the high-speed write mode (HWM = "1")
- In RGB interface mode, the front porch period continues until the next VSYNC input is detected after drawing one frame.
- In RGB interface mode, a GRAM address (DB17-0) is set in the address counter every frame on the falling edge of VSYNC.

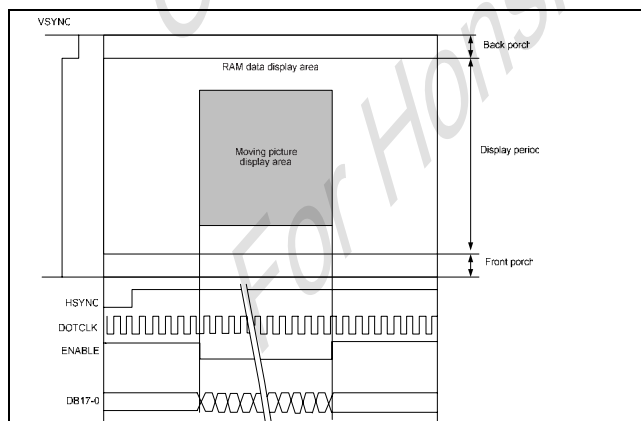

Figure 8-16

RGB interface includes ENABLE signal served as valid data synchronized signals. Moreover, the active level for ENABLE can be set by EPL. The EPL bit inverts the polarity of ENABLE signal. **Table 8-4** summarized the setting of EPL and ENABLE active level for GRAM accessing. Setting both EPL and ENABLE bits to automatically update RAM address in the AC is necessary while writing data to the GRAM.

Table 8-4

EPL	ENABLE	RAM Write	RAM Address
0	0	Enabled	Updated
0	1	Disabled	Retained
1	0	Disabled	Retained
1	1	Enabled	Updated

OTM4001A can support 18-bit, 16-bit and 6-bit RGB interface. The detail timing diagram for 18-bit, 16-bit and 6-bit RGB interfaces are shown in **Figure 8-17** and **Figure 8-18** respectively.

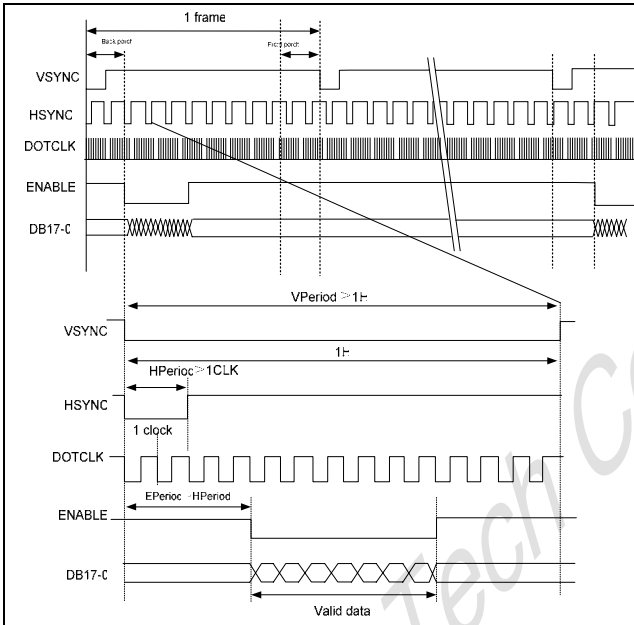

Figure 8-17

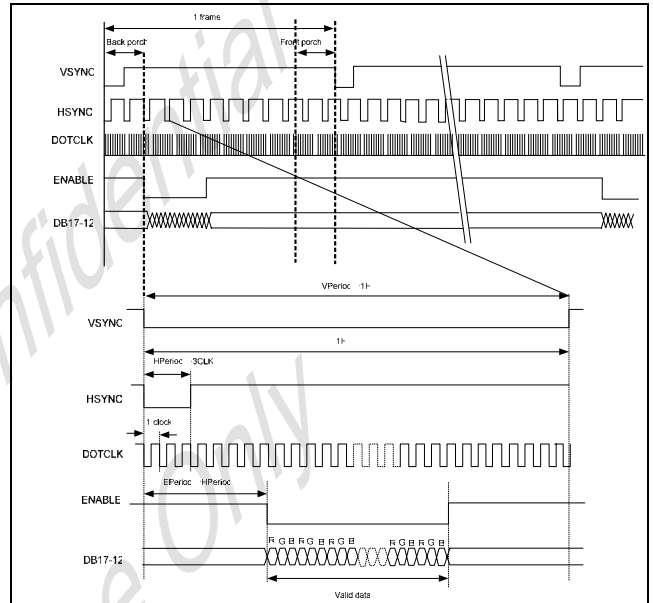

Figure 8-18

The RGB interface also has the window address function to transfer only minimum necessary data on the moving picture GRAM area, which can lower the power consumption and still can use system interface to rewrite data in still picture RAM area while displaying a moving picture. Setting RM = 0 while in RGB interface mode can make GRAM access CBIE through the system interface. When RGB interface accessing GRAM is desired, wait for one read/write bus cycle following by RM = 1 setting.

Figure 8-19 illustrates the timing diagram when displaying a moving picture through the RGB interface and rewriting data in the still picture GRAM area through the system interface.

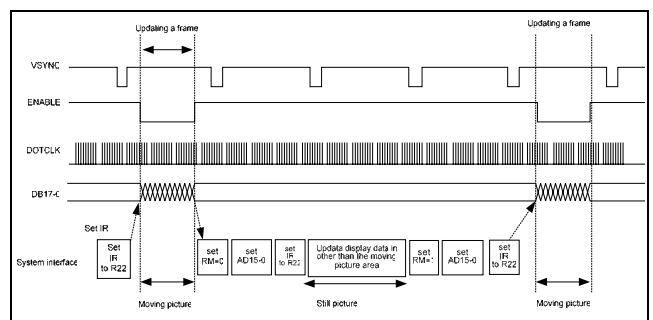

Figure 8-19

8.3.1. 6-bit RGB interface

RAM accessing format and data transmission synchronization of 6-bit RGB interface are shown in **Figure 8-20** and **Figure 8-21**, respectively.

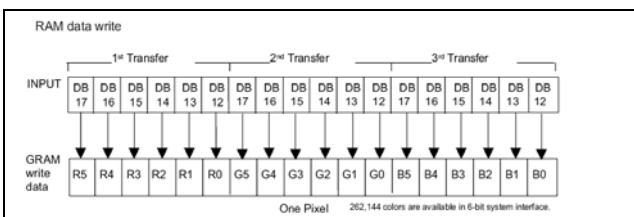

Figure 8-20

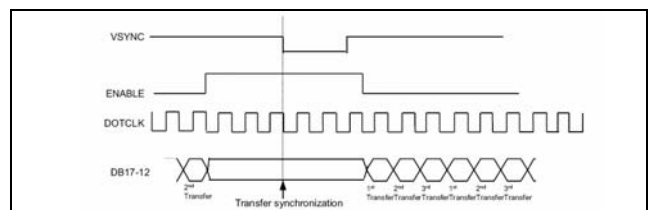

Figure 8-21

8.3.2. 16-bit RGB interface

RAM accessing format of 16-bit RGB interface are shown in Figure 8-22.

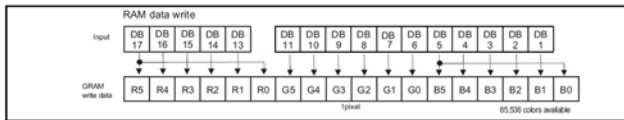

Figure 8-22

8.3.3. 18-bit RGB interface

RAM accessing format of 18-bit RGB interface are shown in Figure 8-23.

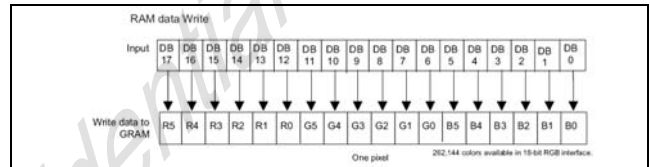

Figure 8-23

9. Display Feature Function:

9.1. FMARK function:

OTM4001A provided FMARK function which output signal to alert host MCU via FMARK I/O pad so that LCD display can avoid flicker effect. FMARK output position and onterval can be set by FMP[8:0] and FMI[2:0], respectively.

Figure 9-1 illustrated the FMARK output position when FMP[8:0]=9'h008.

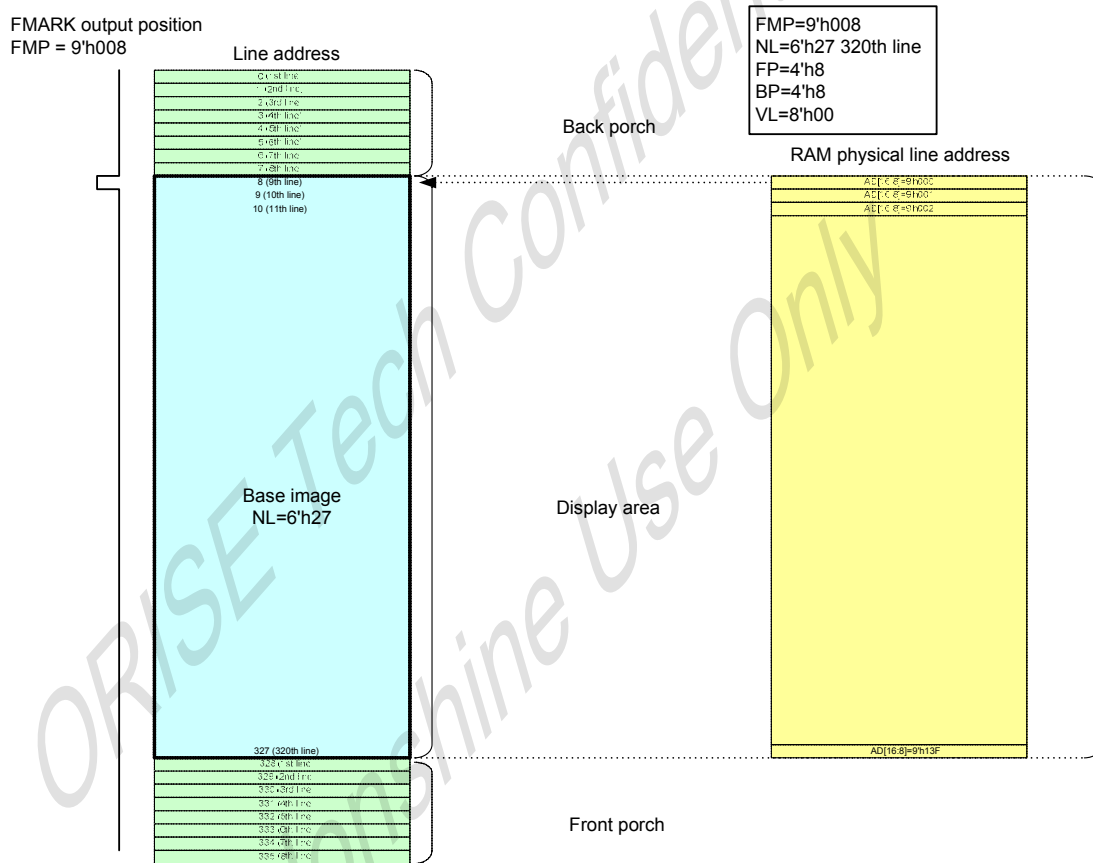
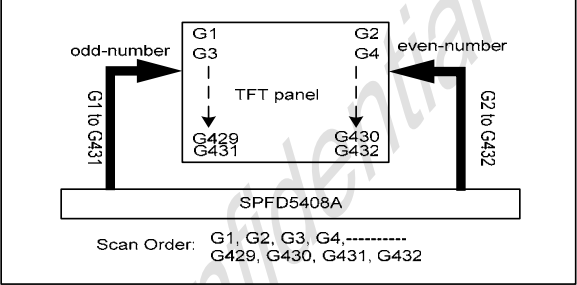
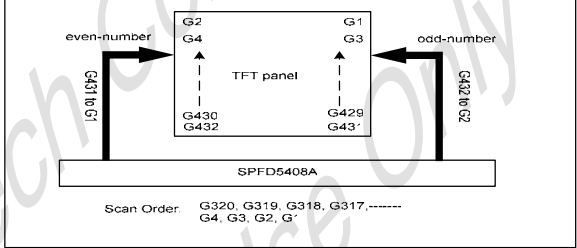
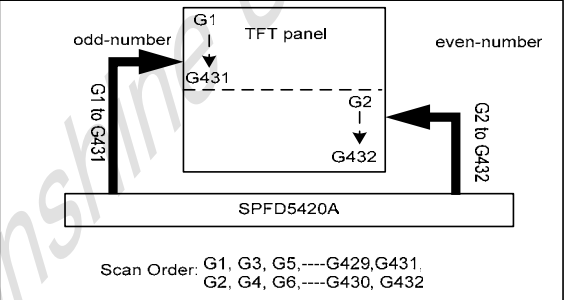
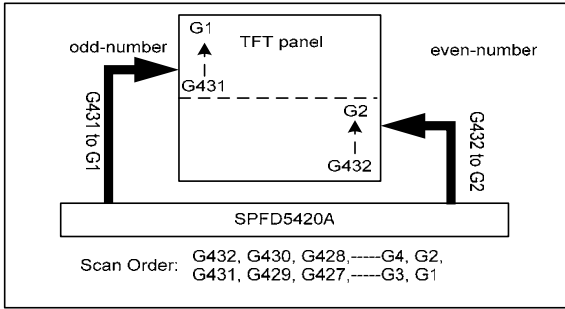

Figure 9-1 Example of FMARK signal.

9.2. Scan Mode function:

SM	GS	Scan Direction
0	0	 <p>Scan Order: G1, G2, G3, G4,----- G429, G430, G431, G432</p>
0	1	 <p>Scan Order: G320, G319, G318, G317,----- G4, G3, G2, G1</p>
1	0	 <p>Scan Order: G1, G3, G5,----G429, G431, G2, G4, G6,----G430, G432</p>
1	1	 <p>Scan Order: G432, G430, G428,----G4, G2, G431, G429, G427,----G3, G1</p>

9.3. Partial Display function:

OTM4001A has partial display function feature which can provide only partial display for power saving purpose. Partial display function can be accessed by setting BSEE="0",. Moreover, 2 partial display area (partial image 1/ partial image 2) can be initialized by setted PTDE0="1" and PTDE1="1", respectively. The partial display area for partial image 1 and partial 2 can be set by PTSA0 / PTEA0 and PTSA1/ PTEA1, respectively. **Table 9-1** and **Figure 9-2** summarized the full and partial display function.

Table 9-1 Partial display function summary table

Case	Function Setting	Display area setting	Display Position
Full display	BASEE="1" PTDE0="x" PTDE1="x"	(BSA, BEA)	-
Partial image1:On Partial image2:Off	BASEE="0" PTDE0="1" PTDE1="0"	(PTSA0,PTEA0)	PTDP0
Partial image1:Off Partial image2:On	BASEE="0" PTDE0="0" PTDE1="1"	(PTSA1,PTEA1)	PTDP1
Partial image1:On Partial image2:On	BASEE="0" PTDE0="1" PTDE1="1"	(PTSA0,PTEA0) (PTSA1,PTEA1)	PTDP0 & PTDP1

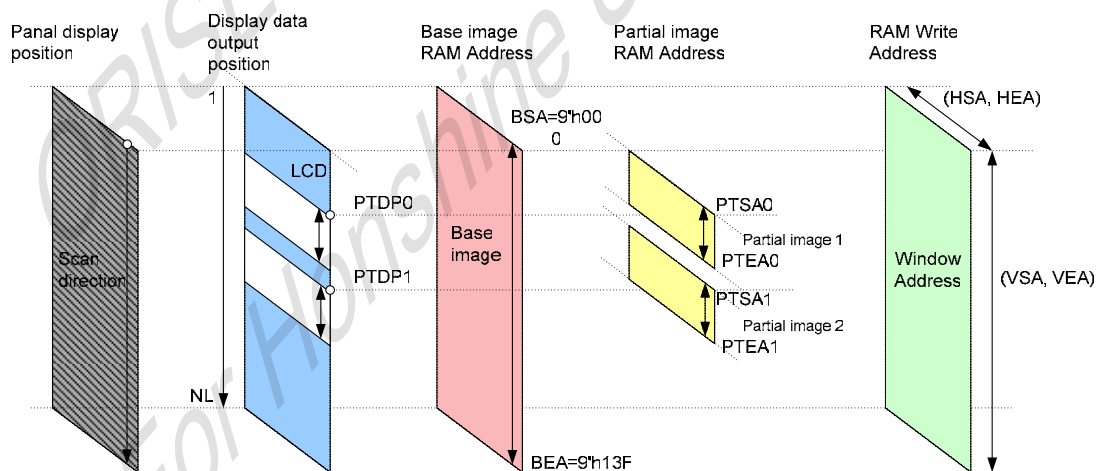

Figure 9-2 Partial display function diagram

Figure 9-3 indicated the case of NL[5:0] setting is < 6'h35 which active line is less than 432. Partial display image data can stored in not active area.

Figure 9-4 indicated the partial display area start position. The partial display area and start position can be set by (PTSA0, PTEA0), (PTSA1, PTEA1) and (PTDP0, PTDP1).

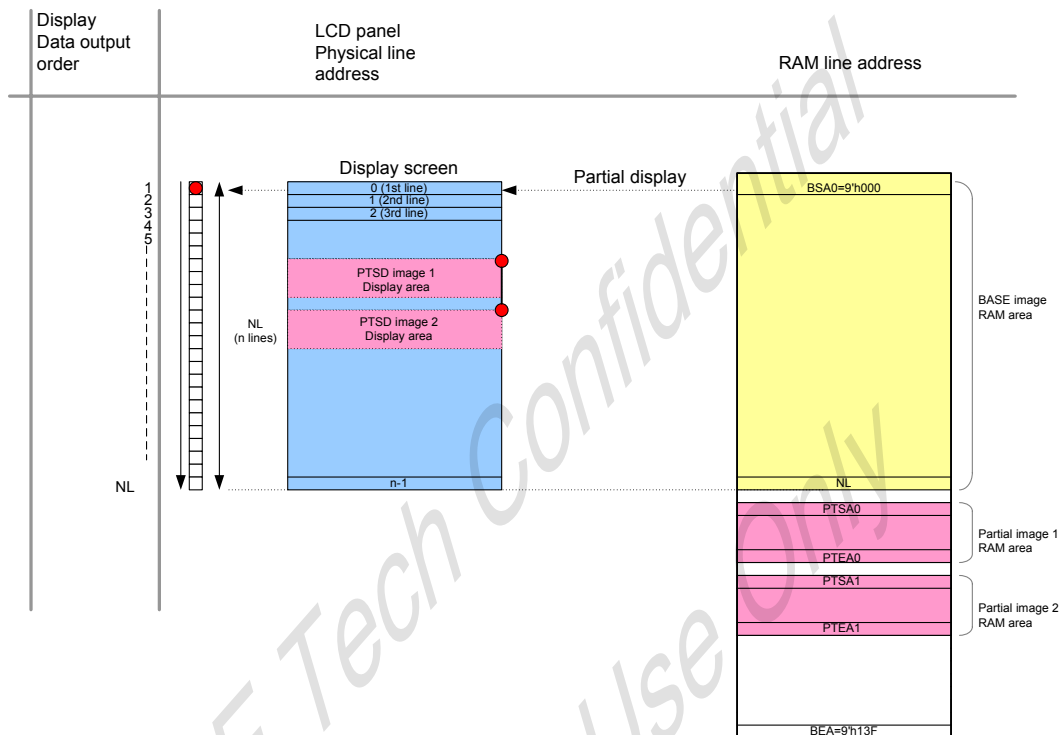

Figure 9-3 Example of NL[5:0] setting is < 6'h35 case

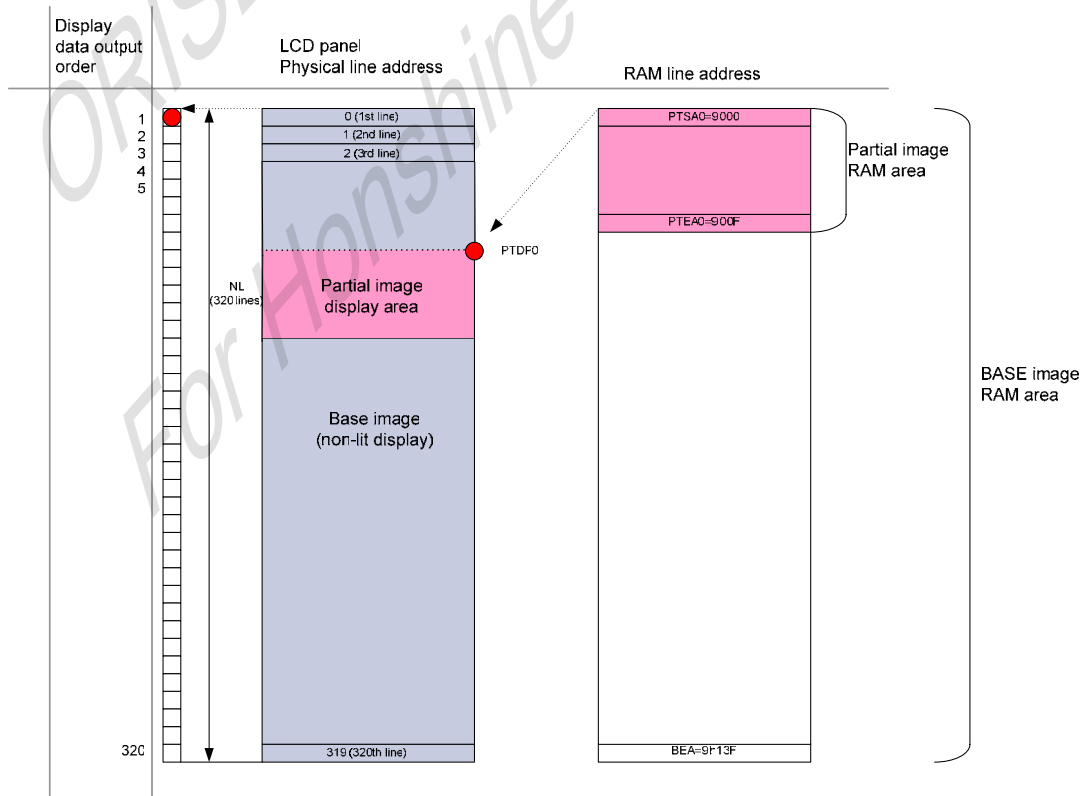

Figure 9-4 indicated the partial display area start position.

9.4. Gamma Correction functions:

OTM4001A adopt Gamma voltage generation circuit which can provide wider output voltage range to fit the different kind of liquid crystal for Gamma curve from 1.0~2.5. The Gamma output voltage can be set by R300h~R3F0h.

V1RP[4:0]: register for positive VSD0 fine tune adjustment.
 V2RP[5:0]: register for positive VSD1 fine tune adjustment.
 V3RP[5:0]: register for positive VSD2 fine tune adjustment.
 V4RP[5:0]: register for positive VSD61 fine tune adjustment.
 V5RP[5:0]: register for positive VSD62 fine tune adjustment.
 V6RP[4:0]: register for positive VSD63 fine tune adjustment
 V7RP[4:0]: register for positive VSD13 fine tune adjustment
 V8RP[4:0]: register for positive VSD50 fine tune adjustment
 V9RP[3:0]: register for positive VSD4 fine tune adjustment
 V10RP[3:0]: register for positive VSD8 fine tune adjustment
 V11RP[3:0]: register for positive VSD20 fine tune adjustment
 V12RP[3:0]: register for positive VSD27 fine tune adjustment
 V13RP[3:0]: register for positive VSD36 fine tune adjustment
 V14RP[3:0]: register for positive VSD43 fine tune adjustment
 V15RP[3:0]: register for positive VSD55 fine tune adjustment
 V16RP[3:0]: register for positive VSD59 fine tune adjustment

V1RN[4:0]: register for negative VSD0 fine tune adjustment.
 V2RN[5:0]: register for negative VSD1 fine tune adjustment.
 V3RN[5:0]: register for negative VSD2 fine tune adjustment.
 V4RN[5:0]: register for negative VSD61 fine tune adjustment.
 V5RN[5:0]: register for negative VSD62 fine tune adjustment.
 V6RN[4:0]: register for negative VSD63 fine tune adjustment
 V7RN[4:0]: register for negative VSD13 fine tune adjustment
 V8RN[4:0]: register for negative VSD50 fine tune adjustment
 V9RN[3:0]: register for negative VSD4 fine tune adjustment
 V10RN[3:0]: register for negative VSD8 fine tune adjustment
 V11RN[3:0]: register for negative VSD20 fine tune adjustment
 V12RN[3:0]: register for negative VSD27 fine tune adjustment
 V13RN[3:0]: register for negative VSD36 fine tune adjustment
 V14RN[3:0]: register for negative VSD43 fine tune adjustment
 V15RN[3:0]: register for negative VSD55 fine tune adjustment
 V16RN[3:0]: register for negative VSD59 fine tune adjustment

Figure 9-5 illustrated 4 different Gamma Curve.

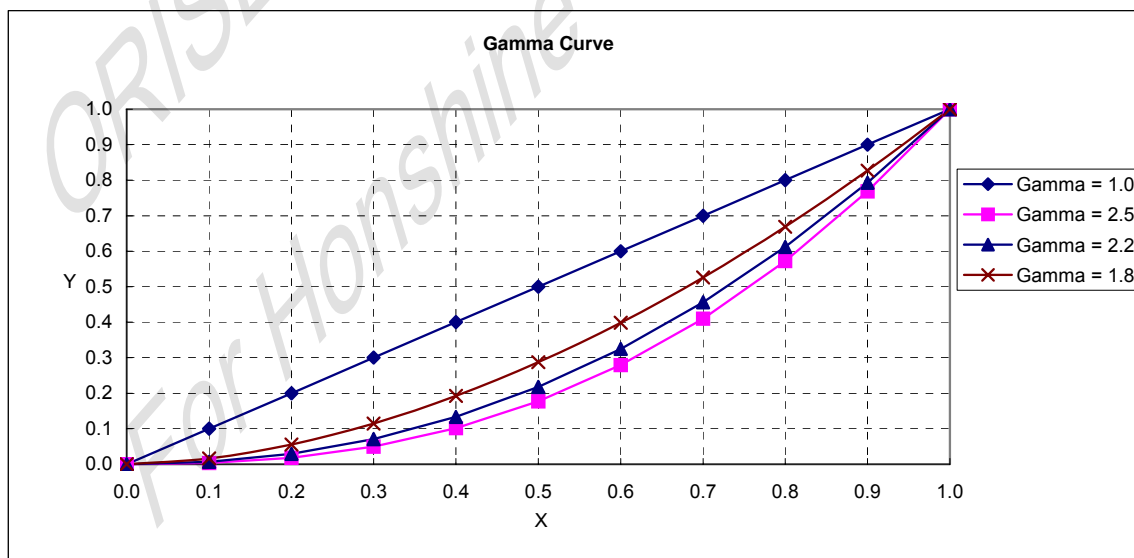

10. Power Management System:

(a) VCI1=VCI direct input

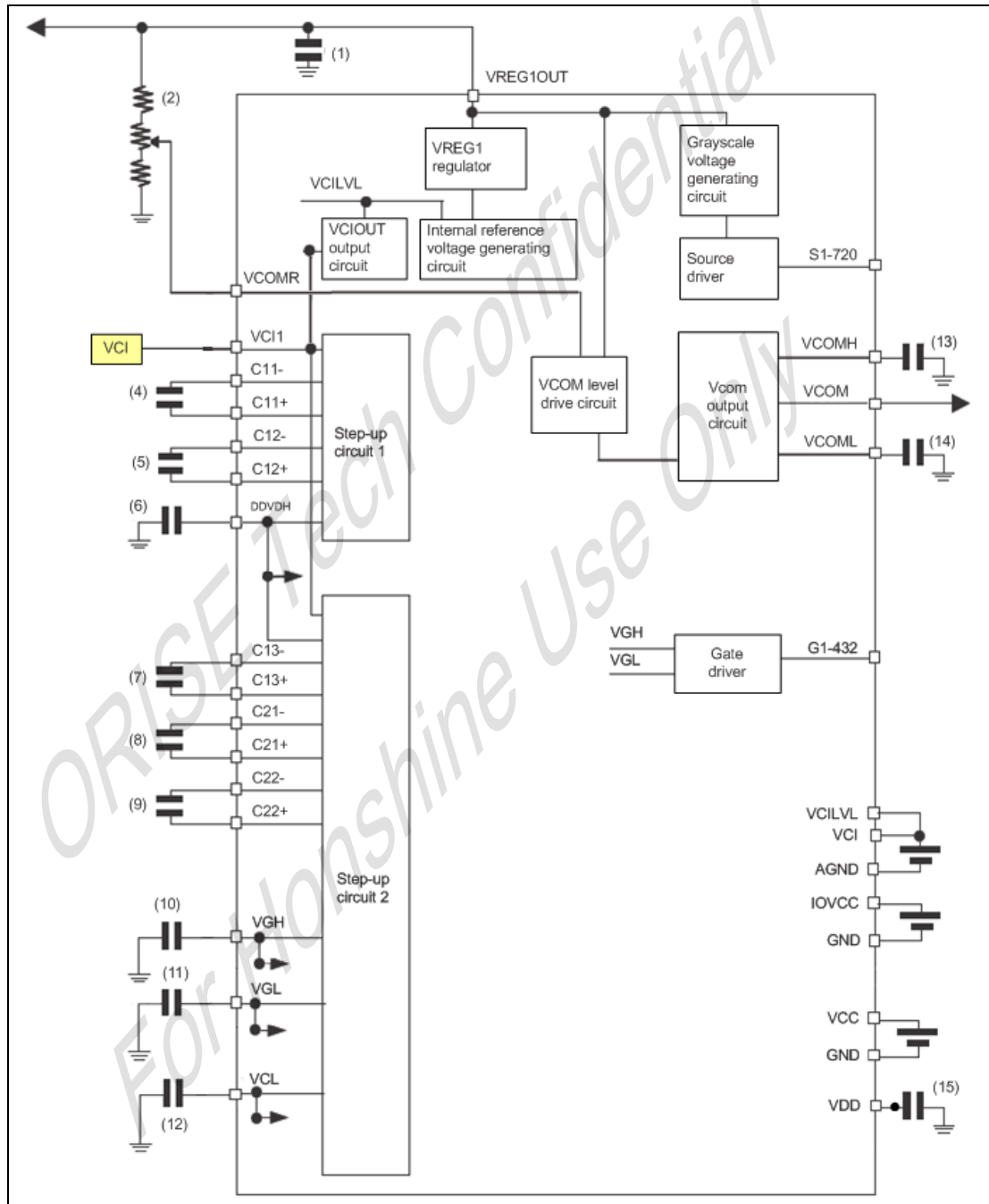

(c) Voltage Generation Diagram

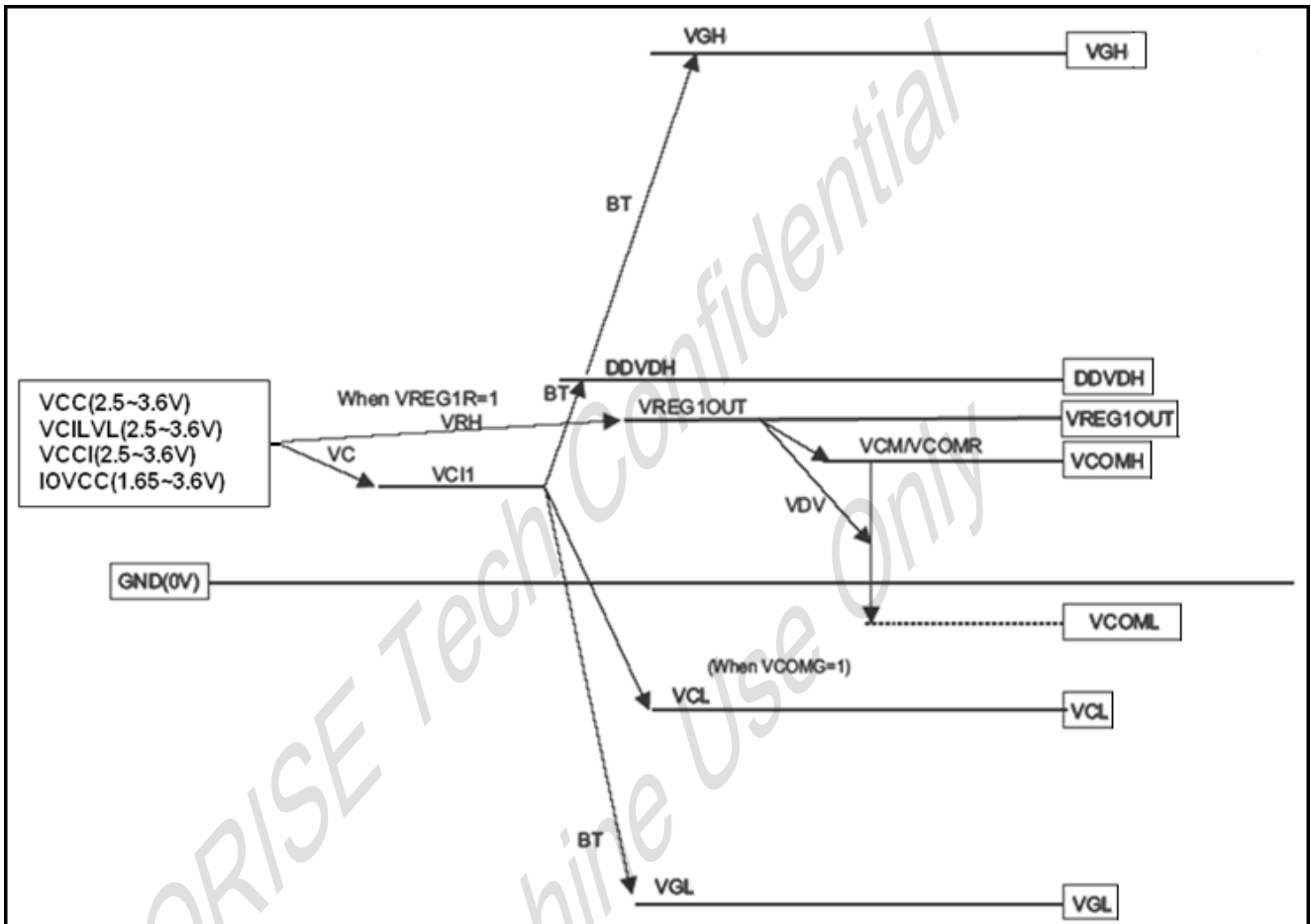

11. Application circuits

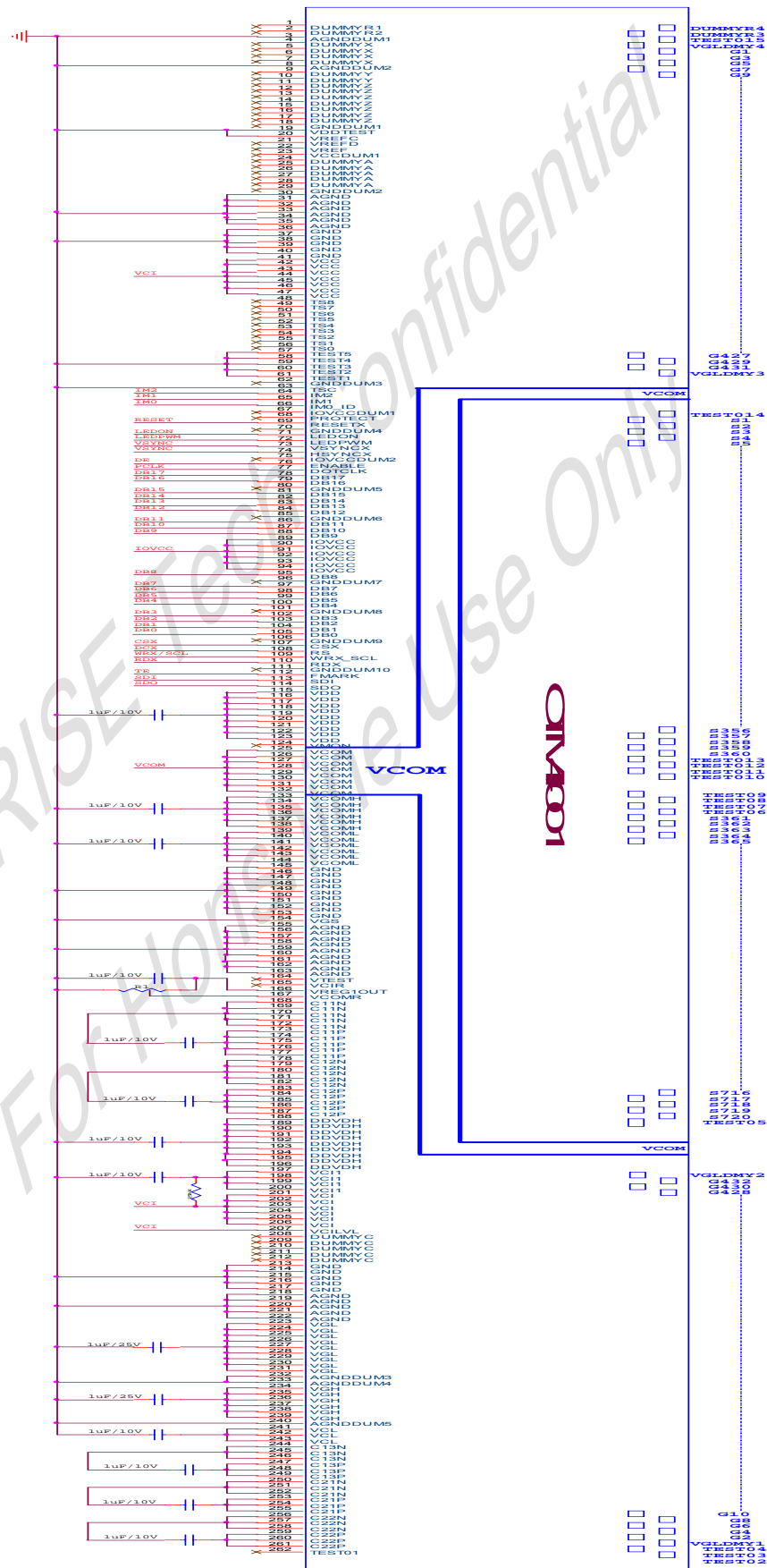

12. Initial Code:

Step	Register Address	Register Value	Note	Step	Register Address	Register Value	Note
1	R0606h	0x0000		44	R0300h	0X0002	
2	Delay 10us			45	R0301h	0X081D	
3	R0007h	0x0001		46	R0302h	0X1621	
4	Delay 10us			47	R0303h	0X3D12	
5	R0110h	0x0001		48	R0304h	0X3C0B	
6	Delay 10us			49	R0305h	0X1004	
7	R0100h	0x17B0		50	R0306h	0X0A06	
8	R0101h	0x0147		51	R0307h	0X0612	
9	R0102h	0x019D		52	R0308h	0X0105	
10	R0103h	0x3600		53	R0309h	0X0004	
11	R0281h	0x0010		54	R030Ah	0X0F05	
12	Delay 10us			55	R030Bh	0X0F00	
13	R0102	0x01BD		56	R030Ch	0X000F	
14	Delay10us			57	R030Dh	0X050F	
14	R0000h	0x0000		58	R030Eh	0X0106	
15	R0001h	0x0000		59	R030Fh	0X0406	
16	R0002h	0x0100		60	R0400h	0X3500	
17	R0003h	0xD090		61	R0401h	0X0001	
18	R0008h	0x0503		62	R0404h	0X0000	
19	R0009h	0x0001		63	R0500h	0X0000	
20	R000Bh	0x0010		64	R0501h	0X0000	
21	R000Ch	0x0000		65	R0502h	0X0000	
22	R000Fh	0x0000		66	R0503h	0X0000	
23	R0007h	0x0001		67	R0504h	0X0000	
24	R0010h	0x0010		68	R0505h	0X0000	
25	R0011h	0x0202		69	R0600h	0X0000	
26	R0012h	0x0300		70	R0606h	0X0000	
27	R0020h	0x021E		71	R06F0h	0X0000	
28	R0021h	0X0202		72	R07F0h	0X5420	
29	R0022h	0X0100		73	R07F2h	0X00DF	
30	R0090h	0X8000		74	R07F3h	0X288A	
31	R0100h	0X16B0		75	R07F4h	0X0022	
32	R0101h	0X0147		76	R07F5h	0X0041	
33	R0102h	0X01BA		77	R07F0h	0X0000	
34	R0103h	0X0600		78	R0007h	0X0173	
35	R0107h	0X0000					
36	R0110h	0X0001					
37	R0210h	0X0000					
38	R0211h	0X00EF					
39	R0212h	0X0000					
40	R0213h	0X01AF					
41	R0280h	0X0000					
42	R0281h	0X0000					
43	R0282h	0X0000					

13. Electrical Characteristics:
13.1. Absolute Maximum Ratings:
Table 13-1

Item	Symbol	Value	Unit	Note
Power Supply Voltage1	VCC,IOVCC	-0.3 ~+4.6	V	
Power Supply Voltage 2	VCI – AGND	-0.3 ~+4.6	V	
Power Supply Voltage 3	DDVDH – AGND	-0.3 ~+6.5	V	
Power Supply Voltage4	AGND – VCL	-0.3 ~+4.6	V	
Power Supply Voltage 5	DDVDH – VCL	-0.3 ~+9.0	V	
Power Supply Voltage7	AGND – VGL	-0.3 ~+14.0	V	
Power Supply Voltage 8	VGH– VGL	-0.3 ~+30.0	V	
Input Voltage	Vt	-0.3 ~IOVCC + 0.3	V	
Operating Temperature	Topr	-40 ~+85	°C	
Storage Temperature	Tstg	-55 ~+110	°C	

13.2. DC Characteristics
Table 13-2

VCC= 2.50V~3.60V, IOVCC=1.65V~ 3.60V, Ta=-40°C~+85°C

Item	Sym bol	Unit	Test Condition	Min.	Typ.	Max.	Note
Input High level voltage	VIH	V	IOVCC=1.65V~3.60V	0.8xIOVCC	-	IOVCC	
Input Low level voltage	VIL	V	IOVCC=1.65V~3.60V	-0.3	-	0.2xIOVCC	
Output "High" level voltage 1 (DB0-17)	VOH	V	IOVCC=1.65V~3.60V, IOH=-0.1mA	0.8xIOVCC	-	-	
Output "Low" level voltage 1 (DB0-17)	VOL	V	IOVCC=1.65V~3.60V, IOL=0.1mA	-	-	0.2xIOVCC	
I/O leak current	ILI1	μA	Vin=0~IOVCC1	-1	-	1	
Current Consumption (IOVCC-IOGND)+(VCC-GND) Normal operation mode (262k-colors, display operation)	IOP1	μA	fosc=678kHz (432 line drive), IOVCC=VCC=3.00V fFLM=60Hz Ta=25°C RAM data: 18'h000000	-	175	-	
Current Consumption (IOVCC-IOGND)+(VCC-GND) 8-color mode, 64-line, partial display operation	Iop2	μA	fosc=376kHz (64-line, partial display), IOVCC=VCC=3.00V, fFLM=40Hz Ta=25°C RAM data: 18'h'000000	-	140	-	

13.3. AC Characteristics

VCC= 2.50V~3.60V, IOVCC=1.65V~3.60V, Ta=-40°C~+85°C

13.3.1. Clock Characteristics

Table 13-3

Item	Symbol	Unit	Timing Diagram	Min.	Typ.	Max.	Note
RC Oscillation clock	fosc	kHz	IOVCC = VCC = 3.0V, 25°C	384	427	470	

NOTE : Value of Typ.、Min. and Max. is decided by the setting of Initial Code at Page 61

80-System Bus Interface Timing Characteristics

Table 13-4 Normal write operation (HWM=0), IOVCC=1.65V~3.60V

Item	Symbol	Unit	Min.	Typ.	Max.
Bus cycle time	Write	tCYCW	ns	150	-
	Read	tCYCR	ns	450	-
Write low-level pulse width	PWLW	ns	55	-	-
Read low-level pulse width	PWLR	ns	170	-	-
Write high-level pulse width	PWHW	ns	70	-	-
Read high-level pulse width	PWHR	ns	250	-	-
Write/Read rise/ fall time	tWRr, WRf	ns	-	-	10
Setup time	Write (RS to CS*, WR*)	tAS	ns	0	-
	Read (RS to CS*, RD*)		ns	10	-
Address Hold Time	tAH	ns	2	-	-
Write data setup time	tDSW	ns	25	-	-
Write data hold time	tH	ns	10	-	-
Read data delay time	tDDR	ns	-	-	150
Read data hold time	tDHR	ns	5	-	-

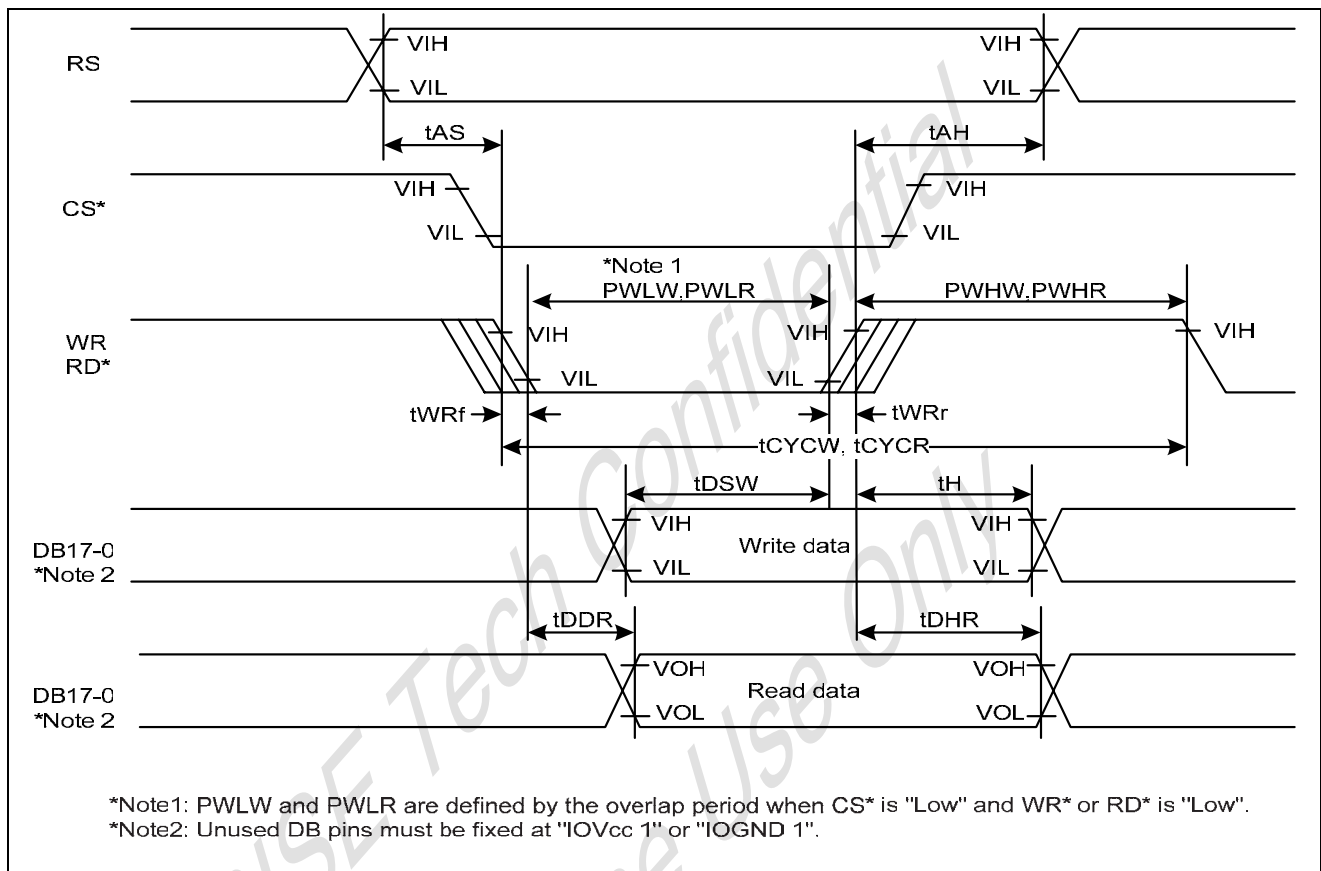

80-System Bus Interface

13.3.2. Clock-synchronized Serial Interface Timing Characteristics

Normal Write Function (HWM=0), High-speed Write Function (HWM=1), IOVCC=1.65~3.60V

Table 13-5

Item	Symbol		Unit	Min.	Typ.	Max.
SerialTime Clock Cycle	Write (received)	tSCYC	ns	100	-	20.000
	Read (transmitted)	tSCYC	ns	350	-	20.000
Serial Clock high-level width	Write (received)	tSCH	ns	40	-	-
	Read (transmitted)	tSCH	ns	150	-	-
Serial Clock low-level width	Write (received)	tSCL	ns	40	-	-
	Read (transmitted)	tSCL	ns	150	-	-
Serial clock rise/fall time		tSCr, tSCf	ns	-	-	20
Chip select setup time		tCSU	ns	20	-	-
Chip select hold time		tCH	ns	60	-	-
Serial input data setup time		tSISU	ns	30	-	-
Serial input data hold time		tSIH	ns	30	-	-
Serial output data delay time		tSOD	ns	-	-	130
Serial output data hold time		tSOH	ns	5	-	-

13.3.3. Reset Timing Characteristics (IOVCC=1.65~3.60V)
Table 13-6

Item	Symbol	Unit	Min.	Typ.	Max.
Reset low-level width	tRES	ms	1	—	—
Reset rise time	trRES	μs	—	—	10

Clock synchronous serial interface

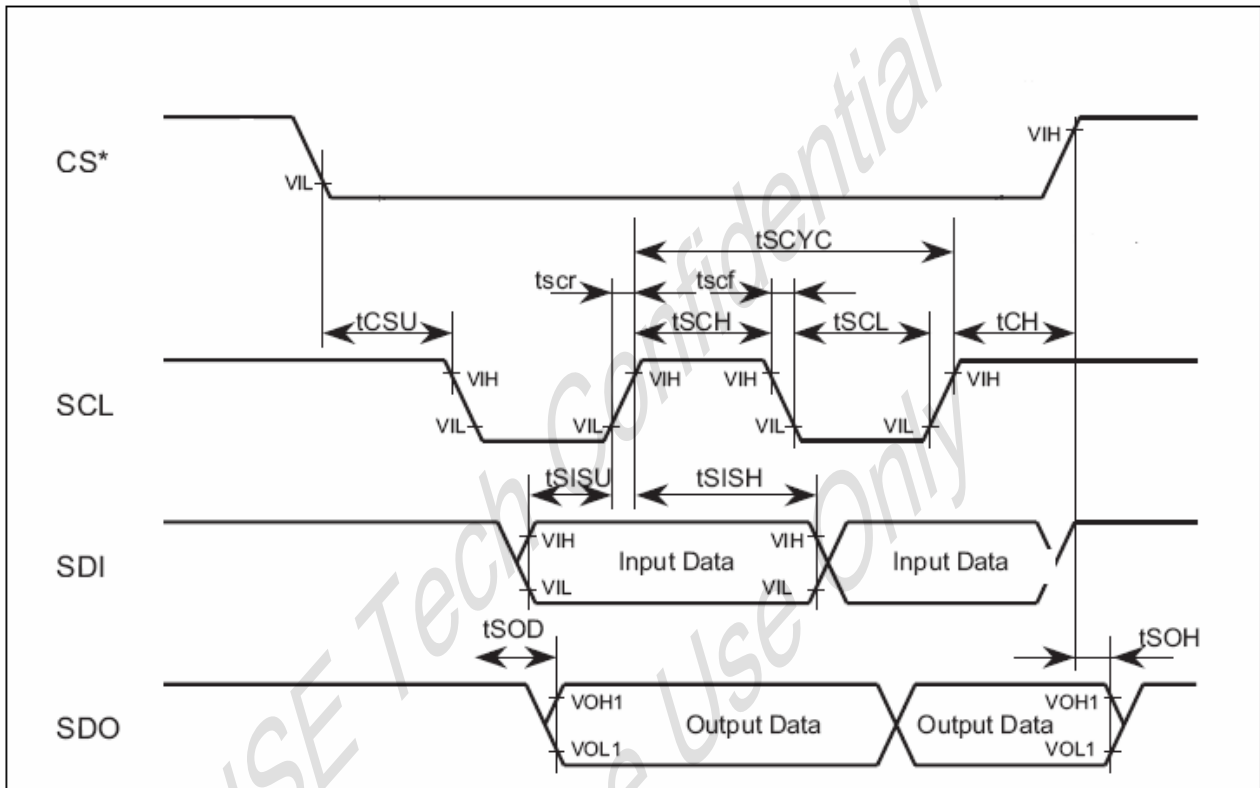

Reset Timing

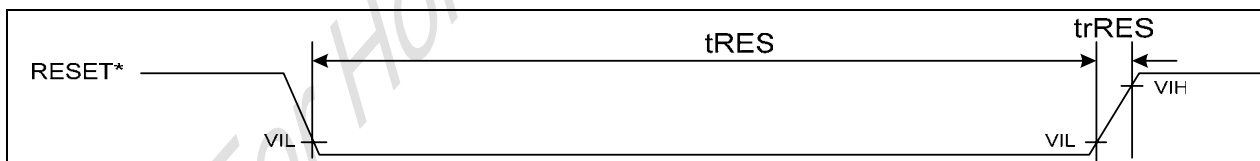

RGB Interface Timing Characteristics
18-/ 16- bit RGB interface (HWM= 1), IOVCC=1.65~3.60V
Table 13-7

Item	Symbol	Unit	Min.	Typ.	Max.
VSYNC/HSYNC Setup time	TSYNCS	clock	0	-	1
ENABLE Setup time	TENS	ns	10	-	-
ENABLE Hold time	TENH	ns	20	-	-
DOTCLK low-level pulse width	PWDL	ns	40	-	-
DOTCLK high-level pulse width	PWDH	ns	40	-	-
DOTCLK cycle time	TCYCD	ns	100	-	-
Data setup time	TPDS	ns	10	-	-
Data hold time	TPDH	ns	40	-	-
DOTCLK, VSYNC and HSYNC rise/fall time	Trgbr Trgbf	ns	-	-	25

6-bit RGB interface (HWM = 1), IOVCC=1.65~3.60V
Table 13-8

Item	Symbol	Unit	Min.	Typ.	Max.
VSYNC/HSYNC setup time	TSYNCS	clock	0	-	1
ENABLE setup time	TENS	ns	10	-	-
ENABLE hold time	TENH	ns	25	-	-
DOTCLK low-level pulse width	PWDL	ns	25	-	-
DOTCLK high-level pulse width	PWDH	ns	25	-	-
DOTCLK cycle time	TCYCD	ns	60	-	-
Data setup-time	TPDS	ns	10	-	-
Data hold time	TPDH	ns	25	-	-
DOTCLK, VSYNC, and HSYNC rise/fall time	Trgb Ttrgbf	ns	-	-	25

RGB Interface

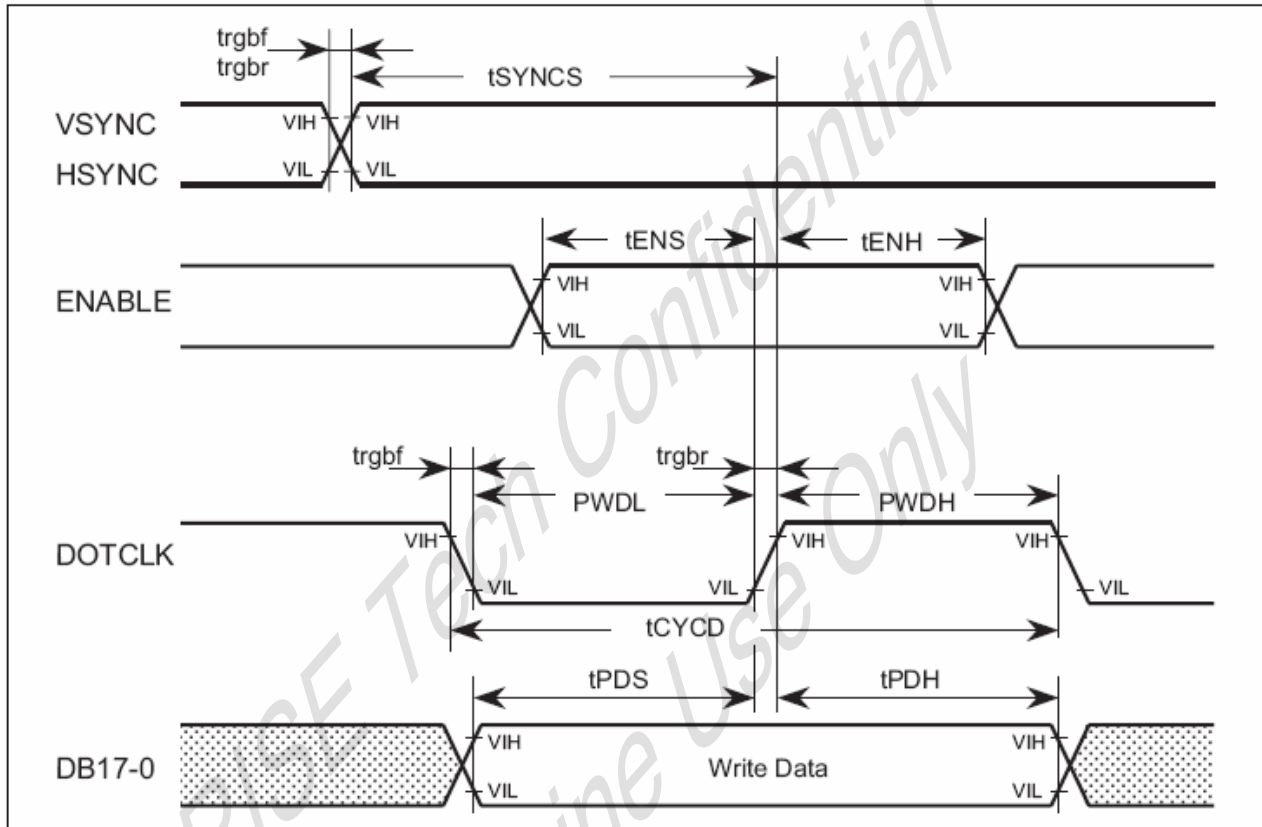

Power On/Off sequence

13.4. Power On / off sequence diagram

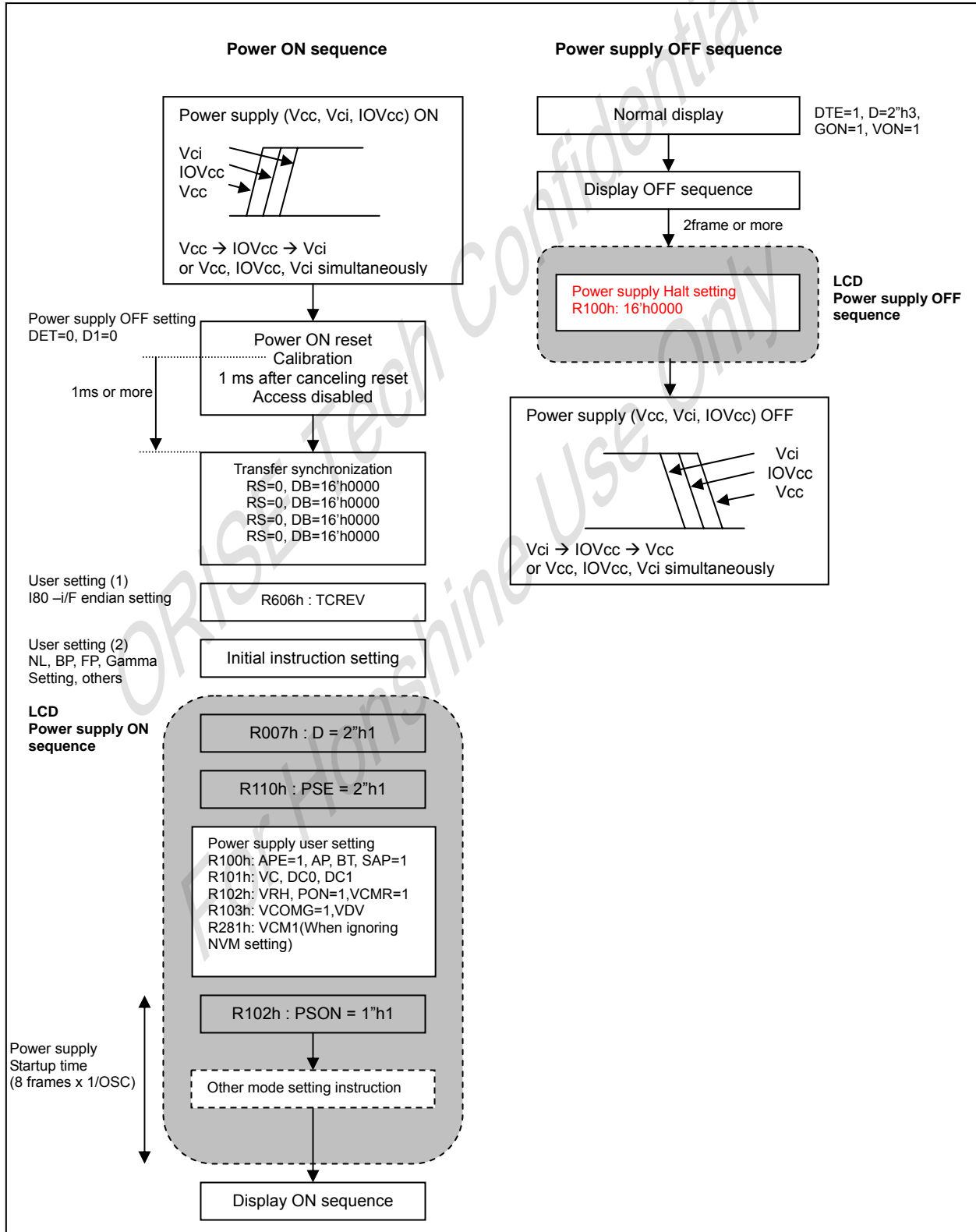

13.5. External-power on/off sequence:

(1) Signal power mode: these three power source VCC, IOVCC and Vci are connected together.

(2) Dual power mode: the two power source VCC and Vci are connected together.

At dual-power mode, VCC power should be earlier turned on than IOVCC, or VCC and VCCI0 should be turned on at same time to ensure that a stable state in OTM4001A internal circuit to avoid the wrong logic signal output. When in shutdown, IOVCC power should be earlier turn off than VCC or at the same time in order to avoid the internal logic circuits to give the unknown signal output.

After IOVCC to achieve stable voltage and keep level more than 1ms (T3), the reset low level need keep more than 1ms (T4) to ensure reset function is executed.

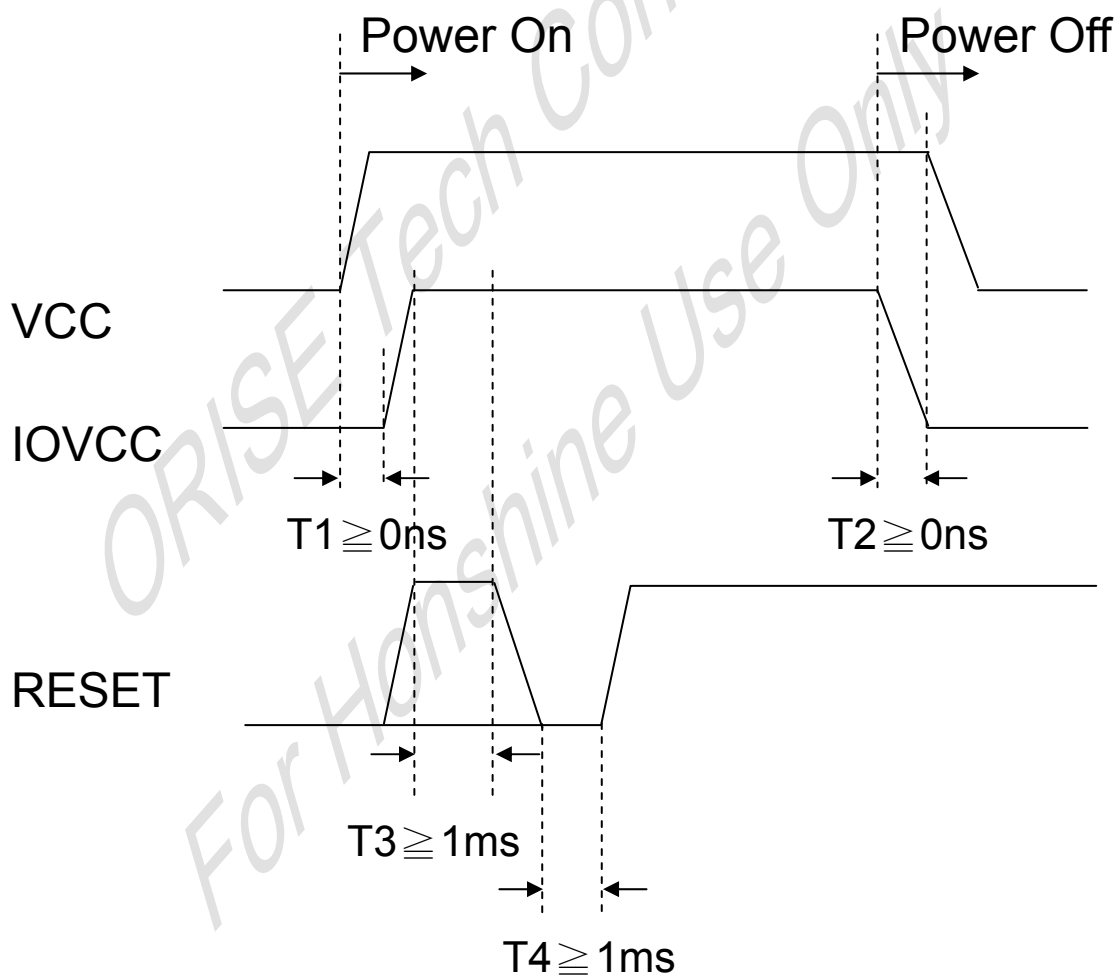

13.6. Display On / Off sequence :

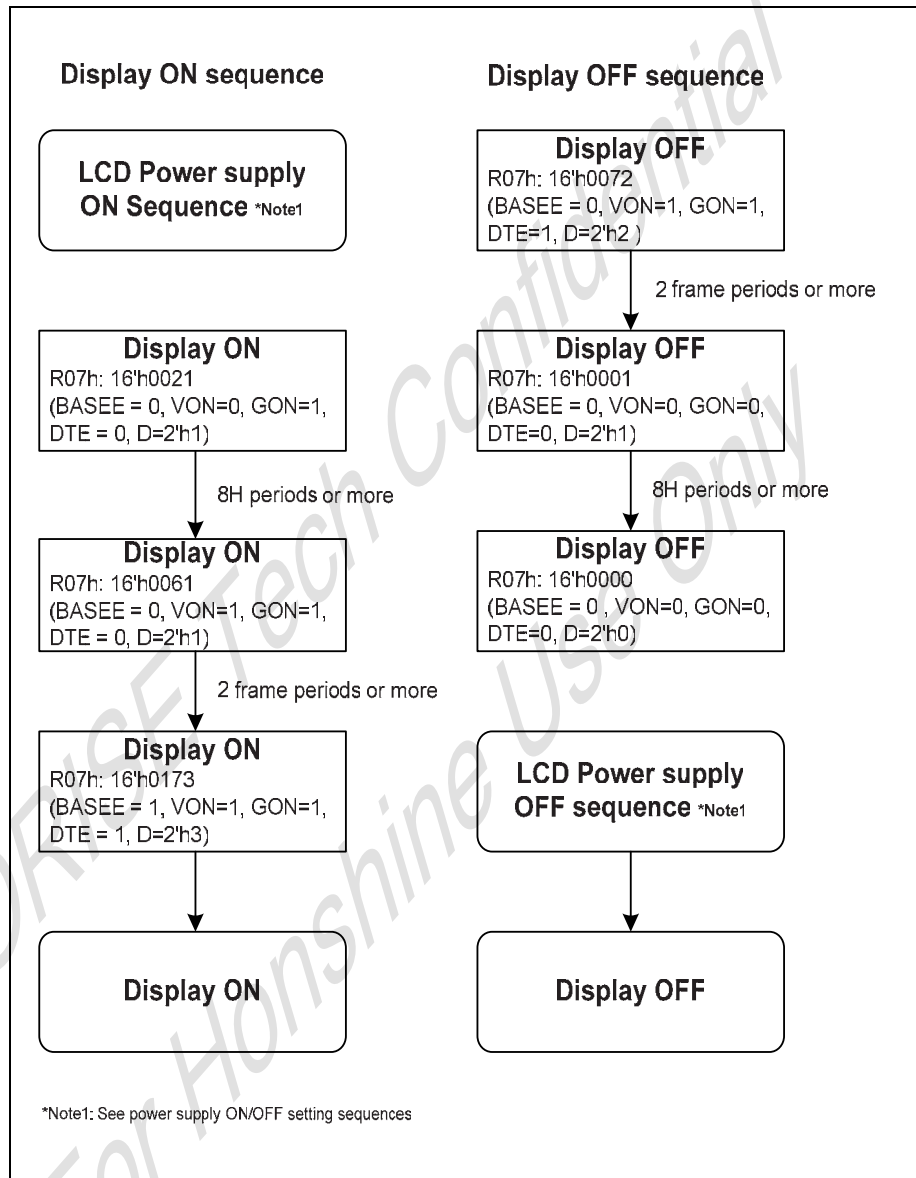

13.7. Sequence to enter and exit sleep mode :

13.7.1. CPU interface mode

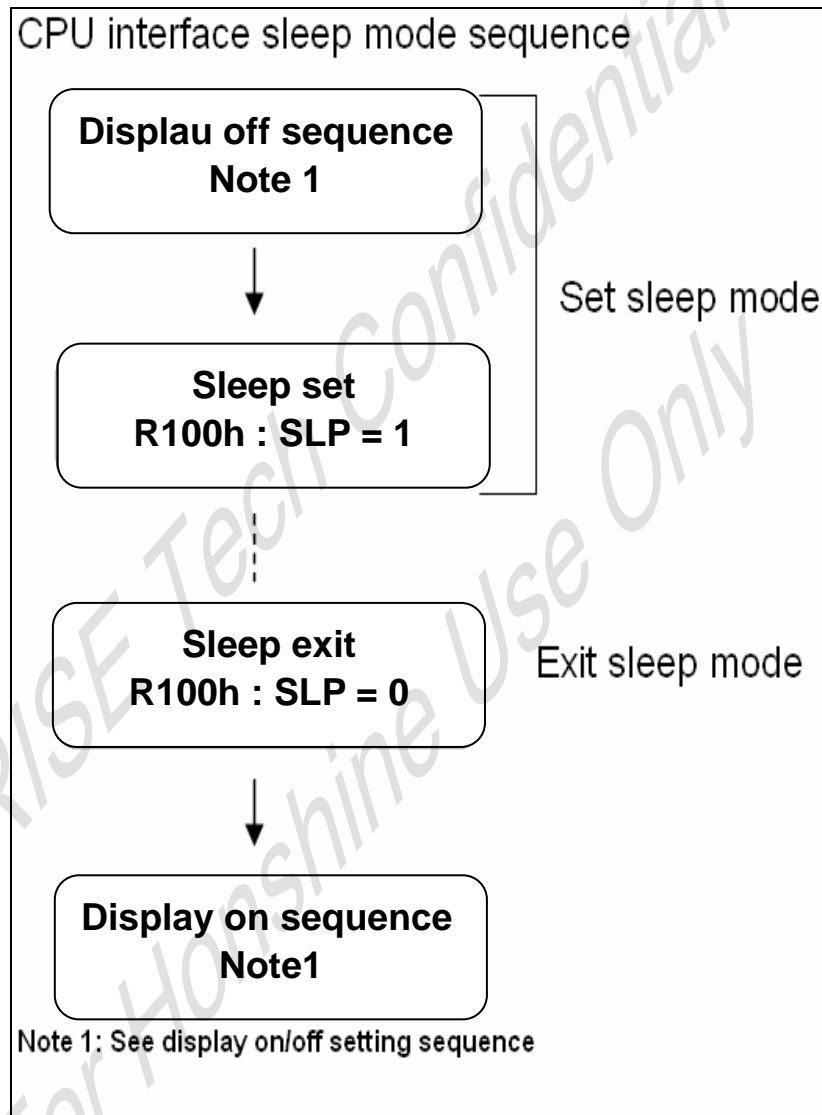

13.7.2. RGB interface mode

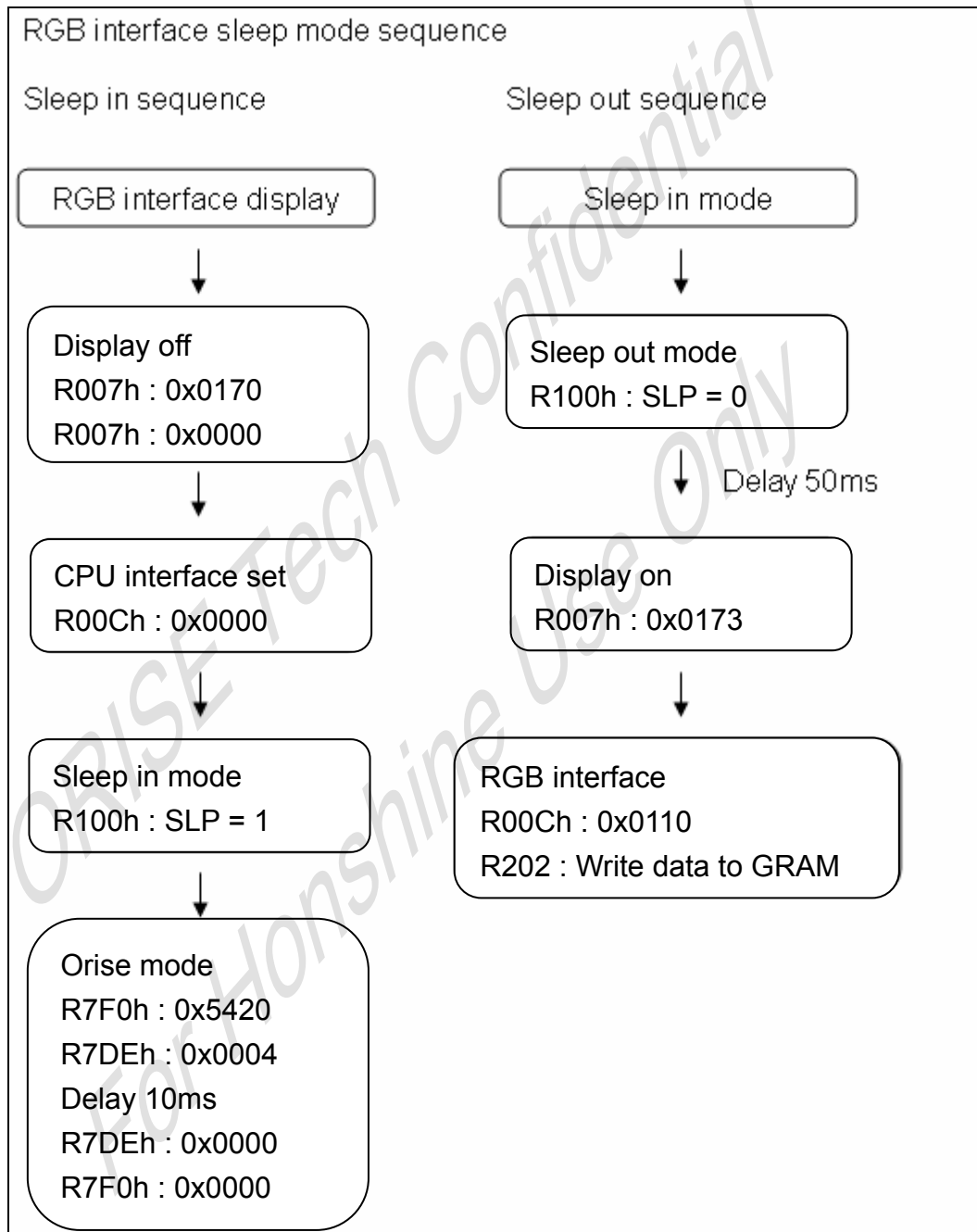

13.8. Partial Display mode

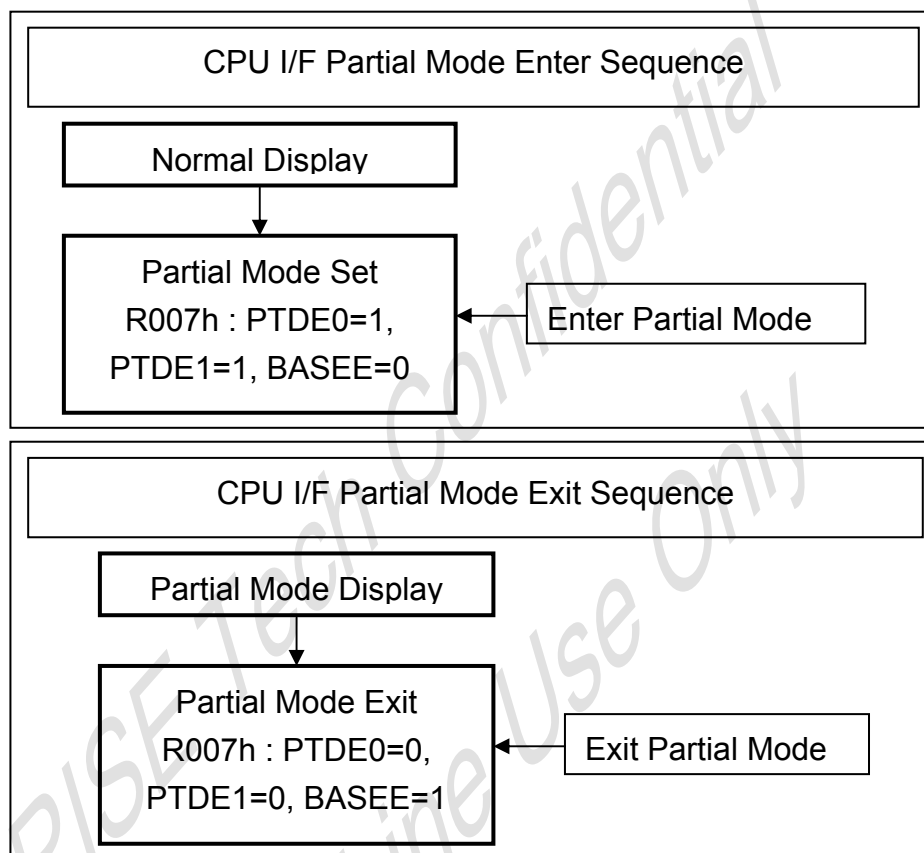

13.9. CPU Interface 8_color mode

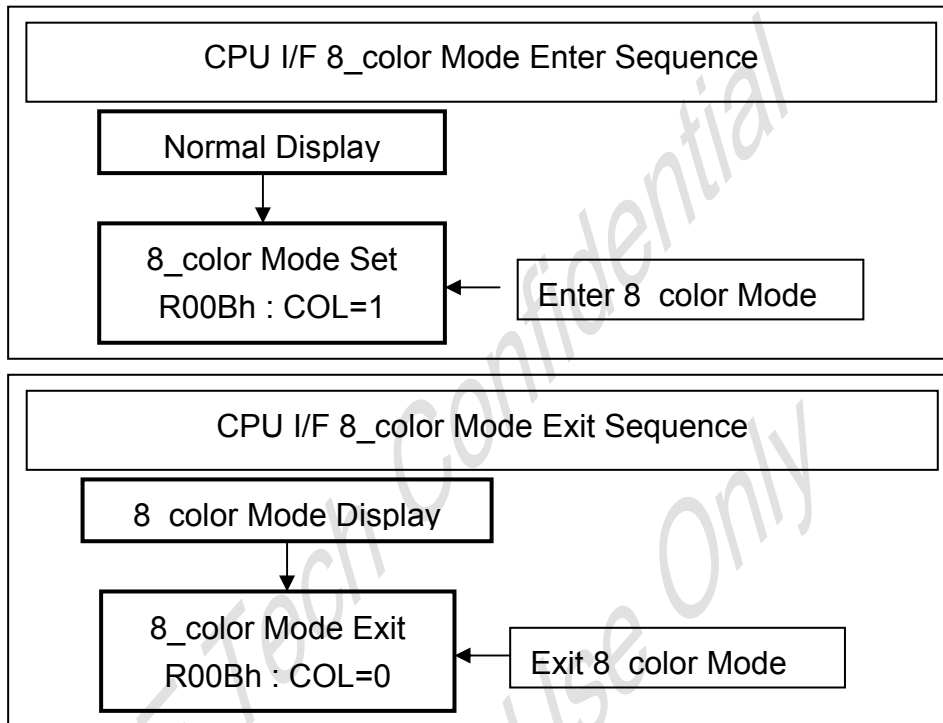

13.10. CPU Interface Deep Standby mode

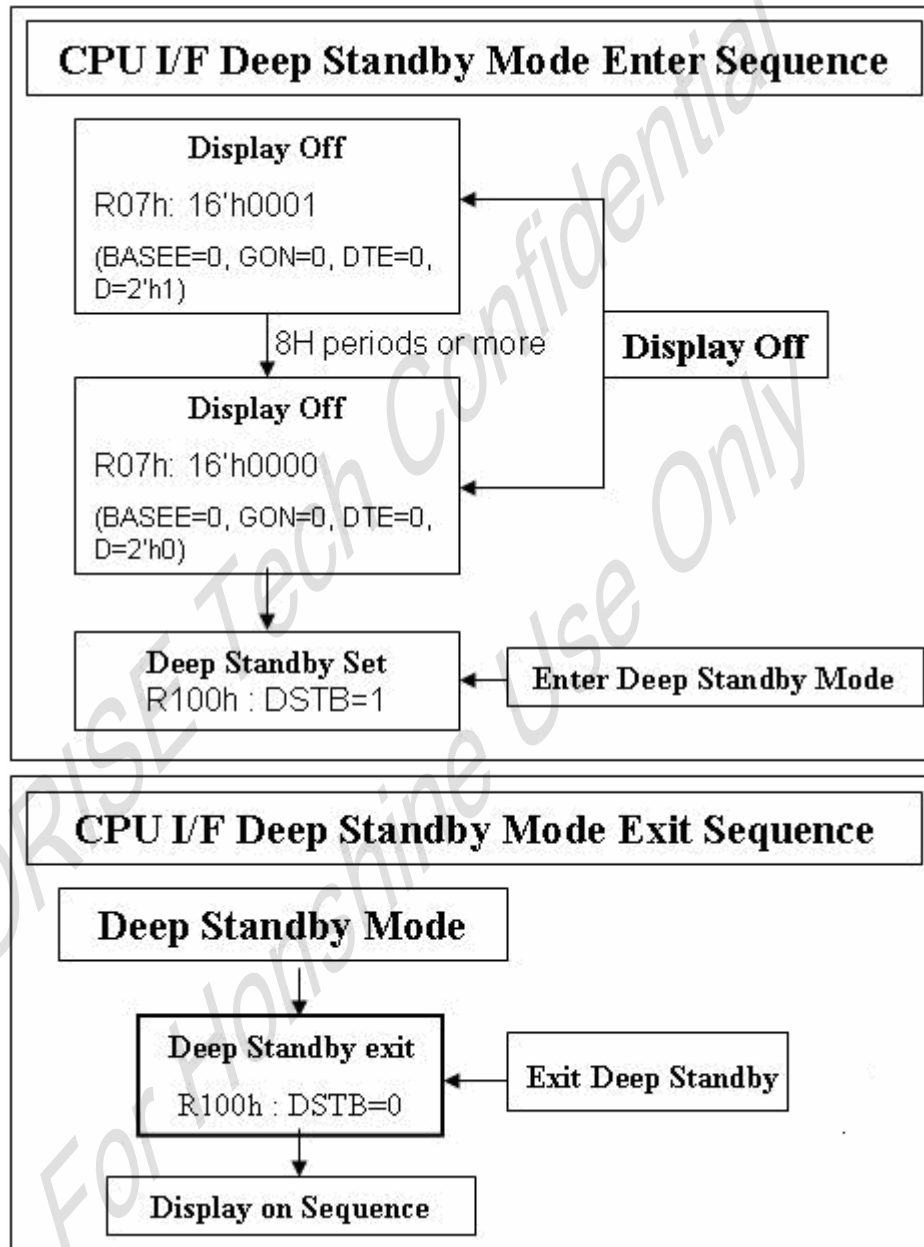

14. CHIP INFORMATION
14.1. PAD Assignment

14.2. PAD Dimension

Item	PAD No.	Size		Unit
		X	Y	
Chip Size	-	19030	840	μm
Chip thickness	-	300 ± 20		
Pad pitch	1-262	70	-	
	263~1434	15	-	
Pad size	1-262	50	90	
	263-1434	15	100	

Note1: Chip size included scribe line.

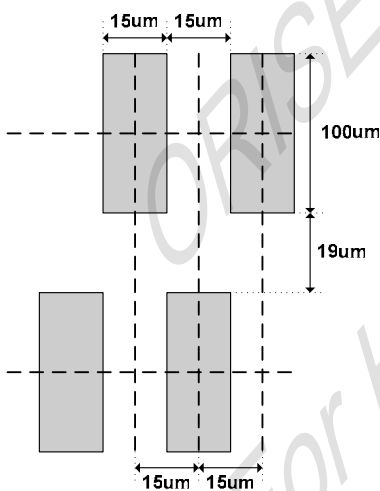
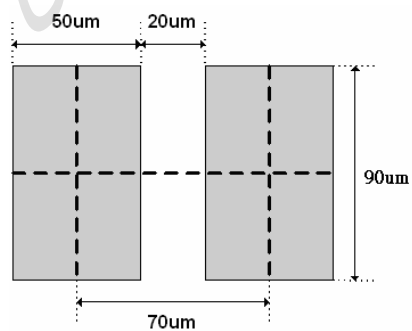
14.2.1. Output Pads

14.2.2. Input Pads

14.3. Bump Characteristics

Item	Standard	Note
Bump Hardness	90Hv	± 30Hv
Bump Height	12μm	± 3μm
Co-planarity (in Chip)	R ≤ 2μm	R : Max-Min
Roughness (in Bump)	R ≤ 2μm	R : Max-Min
Bump Size	Long side ± 2.5μm, short side ± 2μm	
Shear Force	> 5 g/mil ²	

14.4. Pad Locations

NO.	PAD Name	X	Y	NO.	PAD Name	X	Y	NO.	PAD Name	X	Y
1	DUMMYR1	-9135	-289	51	TS5	-5635	-289	101	GNDDUM8	-2135	-289
2	DUMMYR2	-9065	-289	52	TS4	-5565	-289	102	DB3	-2065	-289
3	AGNDDUM1	-8995	-289	53	TS3	-5495	-289	103	DB2	-1995	-289
4	DUMMYX	-8925	-289	54	TS2	-5425	-289	104	DB1	-1925	-289
5	DUMMYX	-8855	-289	55	TS1	-5355	-289	105	DB0	-1855	-289
6	DUMMYX	-8785	-289	56	TS0	-5285	-289	106	GNDDUM9	-1785	-289
7	DUMMYX	-8715	-289	57	TEST5	-5215	-289	107	CSX	-1715	-289
8	AGNDDUM2	-8645	-289	58	TEST4	-5145	-289	108	RS	-1645	-289
9	DUMMYY	-8575	-289	59	TEST3	-5075	-289	109	WRX_SCL	-1575	-289
10	DUMMYY	-8505	-289	60	TEST2	-5005	-289	110	RDX	-1505	-289
11	DUMMYZ	-8435	-289	61	TEST1	-4935	-289	111	GNDDUM10	-1435	-289
12	DUMMYZ	-8365	-289	62	GNDDUM3	-4865	-289	112	FMARK	-1365	-289
13	DUMMYZ	-8295	-289	63	TSC	-4795	-289	113	SDI	-1295	-289
14	DUMMYZ	-8225	-289	64	IM2	-4725	-289	114	SDO	-1225	-289
15	DUMMYZ	-8155	-289	65	IM1	-4655	-289	115	VDD	-1155	-289
16	DUMMYZ	-8085	-289	66	IM0 ID	-4585	-289	116	VDD	-1085	-289
17	DUMMYZ	-8015	-289	67	IOVCCDUM1	-4515	-289	117	VDD	-1015	-289
18	GNDDUM1	-7945	-289	68	PROTECT	-4445	-289	118	VDD	-945	-289
19	VDDTEST	-7875	-289	69	RESETX	-4375	-289	119	VDD	-875	-289
20	VREFC	-7805	-289	70	GNDDUM4	-4305	-289	120	VDD	-805	-289
21	VREFD	-7735	-289	71	LEDON	-4235	-289	121	VDD	-735	-289
22	VREF	-7665	-289	72	LEDPWM	-4165	-289	122	VDD	-665	-289
23	VCCDUM1	-7595	-289	73	VSYNCX	-4095	-289	123	VDD	-595	-289
24	DUMMYA	-7525	-289	74	HSYNCX	-4025	-289	124	VMON	-525	-289
25	DUMMYA	-7455	-289	75	IOVCCDUM2	-3955	-289	125	VCOM	-455	-289
26	DUMMYA	-7385	-289	76	ENABLE	-3885	-289	126	VCOM	-385	-289
27	DUMMYA	-7315	-289	77	DOTCLK	-3815	-289	127	VCOM	-315	-289
28	DUMMYA	-7245	-289	78	DB17	-3745	-289	128	VCOM	-245	-289
29	GNDDUM2	-7175	-289	79	DB16	-3675	-289	129	VCOM	-175	-289
30	AGND	-7105	-289	80	GNDDUM5	-3605	-289	130	VCOM	-105	-289
31	AGND	-7035	-289	81	DB15	-3535	-289	131	VCOM	-35	-289
32	AGND	-6965	-289	82	DB14	-3465	-289	132	VCOM	35	-289
33	AGND	-6895	-289	83	DB13	-3395	-289	133	VCOMH	105	-289
34	AGND	-6825	-289	84	DB12	-3325	-289	134	VCOMH	175	-289
35	AGND	-6755	-289	85	GNDDUM6	-3255	-289	135	VCOMH	245	-289
36	GND	-6685	-289	86	DB11	-3185	-289	136	VCOMH	315	-289
37	GND	-6615	-289	87	DB10	-3115	-289	137	VCOMH	385	-289
38	GND	-6545	-289	88	DB9	-3045	-289	138	VCOMH	455	-289
39	GND	-6475	-289	89	IOVCC	-2975	-289	139	VCOML	525	-289
40	GND	-6405	-289	90	IOVCC	-2905	-289	140	VCOML	595	-289
41	VCC	-6335	-289	91	IOVCC	-2835	-289	141	VCOML	665	-289
42	VCC	-6265	-289	92	IOVCC	-2765	-289	142	VCOML	735	-289
43	VCC	-6195	-289	93	IOVCC	-2695	-289	143	VCOML	805	-289
44	VCC	-6125	-289	94	IOVCC	-2625	-289	144	VCOML	875	-289
45	VCC	-6055	-289	95	DB8	-2555	-289	145	GND	945	-289
46	VCC	-5985	-289	96	GNDDUM7	-2485	-289	146	GND	1015	-289
47	VCC	-5915	-289	97	DB7	-2415	-289	147	GND	1085	-289
48	TS8	-5845	-289	98	DB6	-2345	-289	148	GND	1155	-289
49	TS7	-5775	-289	99	DB5	-2275	-289	149	GND	1225	-289
50	TS6	-5705	-289	100	DB4	-2205	-289	150	GND	1295	-289

NO.	PAD Name	X	Y	NO.	PAD Name	X	Y	NO.	PAD Name	X	Y
151	GND	1365	-289	203	VCI	5005	-289	255	C21P	8645	-289
152	GND	1435	-289	204	VCI	5075	-289	256	C22N	8715	-289
153	GND	1505	-289	205	VCI	5145	-289	257	C22N	8785	-289
154	VGS	1575	-289	206	VCI	5215	-289	258	C22N	8855	-289
155	AGND	1645	-289	207	VCILVL	5285	-289	259	C22P	8925	-289
156	AGND	1715	-289	208	DUMMYC	5355	-289	260	C22P	8995	-289
157	AGND	1785	-289	209	DUMMYC	5425	-289	261	C22P	9065	-289
158	AGND	1855	-289	210	DUMMYC	5495	-289	262	TESTO1	9135	-289
159	AGND	1925	-289	211	DUMMYC	5565	-289	263	TESTO2	9397.5	177
160	AGND	1995	-289	212	DUMMYC	5635	-289	264	TESTO3	9382.5	296
161	AGND	2065	-289	213	GND	5705	-289	265	TESTO4	9367.5	177
162	AGND	2135	-289	214	GND	5775	-289	266	VGLDMY1	9352.5	296
163	AGND	2205	-289	215	GND	5845	-289	267	G2	9337.5	177
164	VTEST	2275	-289	216	GND	5915	-289	268	G4	9322.5	296
165	VCIR	2345	-289	217	GND	5985	-289	269	G6	9307.5	177
166	VREG1OUT	2415	-289	218	AGND	6055	-289	270	G8	9292.5	296
167	VCOMR	2485	-289	219	AGND	6125	-289	271	G10	9277.5	177
168	C11N	2555	-289	220	AGND	6195	-289	272	G12	9262.5	296
169	C11N	2625	-289	221	AGND	6265	-289	273	G14	9247.5	177
170	C11N	2695	-289	222	AGND	6335	-289	274	G16	9232.5	296
171	C11N	2765	-289	223	VGL	6405	-289	275	G18	9217.5	177
172	C11N	2835	-289	224	VGL	6475	-289	276	G20	9202.5	296
173	C11P	2905	-289	225	VGL	6545	-289	277	G22	9187.5	177
174	C11P	2975	-289	226	VGL	6615	-289	278	G24	9172.5	296
175	C11P	3045	-289	227	VGL	6685	-289	279	G26	9157.5	177
176	C11P	3115	-289	228	VGL	6755	-289	280	G28	9142.5	296
177	C11P	3185	-289	229	VGL	6825	-289	281	G30	9127.5	177
178	C12N	3255	-289	230	VGL	6895	-289	282	G32	9112.5	296
179	C12N	3325	-289	231	VGL	6965	-289	283	G34	9097.5	177
180	C12N	3395	-289	232	AGNDDUM3	7035	-289	284	G36	9082.5	296
181	C12N	3465	-289	233	AGNDDUM4	7105	-289	285	G38	9067.5	177
182	C12N	3535	-289	234	VGH	7175	-289	286	G40	9052.5	296
183	C12P	3605	-289	235	VGH	7245	-289	287	G42	9037.5	177
184	C12P	3675	-289	236	VGH	7315	-289	288	G44	9022.5	296
185	C12P	3745	-289	237	VGH	7385	-289	289	G46	9007.5	177
186	C12P	3815	-289	238	VGH	7455	-289	290	G48	8992.5	296
187	C12P	3885	-289	239	VGH	7525	-289	291	G50	8977.5	177
188	DDVDH	3955	-289	240	AGNDDUM5	7595	-289	292	G52	8962.5	296
189	DDVDH	4025	-289	241	VCL	7665	-289	293	G54	8947.5	177
190	DDVDH	4095	-289	242	VCL	7735	-289	294	G56	8932.5	296
191	DDVDH	4165	-289	243	VCL	7805	-289	295	G58	8917.5	177
192	DDVDH	4235	-289	244	C13N	7875	-289	296	G60	8902.5	296
193	DDVDH	4305	-289	245	C13N	7945	-289	297	G62	8887.5	177
194	DDVDH	4375	-289	246	C13N	8015	-289	298	G64	8872.5	296
195	DDVDH	4445	-289	247	C13P	8085	-289	299	G66	8857.5	177
196	DDVDH	4515	-289	248	C13P	8155	-289	300	G68	8842.5	296
197	VCI1	4585	-289	249	C13P	8225	-289	301	G70	8827.5	177
198	VCI1	4655	-289	250	C21N	8295	-289	302	G72	8812.5	296
199	VCI1	4725	-289	251	C21N	8365	-289	303	G74	8797.5	177
200	VCI1	4795	-289	252	C21N	8435	-289	304	G76	8782.5	296
201	VCI	4865	-289	253	C21P	8505	-289	305	G78	8767.5	177
202	VCI	4935	-289	254	C21P	8575	-289	306	G80	8752.5	296

NO.	PAD Name	X	Y	NO.	PAD Name	X	Y	NO.	PAD Name	X	Y
307	G82	8737.5	177	359	G186	7957.5	177	411	G290	7177.5	177
308	G84	8722.5	296	360	G188	7942.5	296	412	G292	7162.5	296
309	G86	8707.5	177	361	G190	7927.5	177	413	G294	7147.5	177
310	G88	8692.5	296	362	G192	7912.5	296	414	G296	7132.5	296
311	G90	8677.5	177	363	G194	7897.5	177	415	G298	7117.5	177
312	G92	8662.5	296	364	G196	7882.5	296	416	G300	7102.5	296
313	G94	8647.5	177	365	G198	7867.5	177	417	G302	7087.5	177
314	G96	8632.5	296	366	G200	7852.5	296	418	G304	7072.5	296
315	G98	8617.5	177	367	G202	7837.5	177	419	G306	7057.5	177
316	G100	8602.5	296	368	G204	7822.5	296	420	G308	7042.5	296
317	G102	8587.5	177	369	G206	7807.5	177	421	G310	7027.5	177
318	G104	8572.5	296	370	G208	7792.5	296	422	G312	7012.5	296
319	G106	8557.5	177	371	G210	7777.5	177	423	G314	6997.5	177
320	G108	8542.5	296	372	G212	7762.5	296	424	G316	6982.5	296
321	G110	8527.5	177	373	G214	7747.5	177	425	G318	6967.5	177
322	G112	8512.5	296	374	G216	7732.5	296	426	G320	6952.5	296
323	G114	8497.5	177	375	G218	7717.5	177	427	G322	6937.5	177
324	G116	8482.5	296	376	G220	7702.5	296	428	G324	6922.5	296
325	G118	8467.5	177	377	G222	7687.5	177	429	G326	6907.5	177
326	G120	8452.5	296	378	G224	7672.5	296	430	G328	6892.5	296
327	G122	8437.5	177	379	G226	7657.5	177	431	G330	6877.5	177
328	G124	8422.5	296	380	G228	7642.5	296	432	G332	6862.5	296
329	G126	8407.5	177	381	G230	7627.5	177	433	G334	6847.5	177
330	G128	8392.5	296	382	G232	7612.5	296	434	G336	6832.5	296
331	G130	8377.5	177	383	G234	7597.5	177	435	G338	6817.5	177
332	G132	8362.5	296	384	G236	7582.5	296	436	G340	6802.5	296
333	G134	8347.5	177	385	G238	7567.5	177	437	G342	6787.5	177
334	G136	8332.5	296	386	G240	7552.5	296	438	G344	6772.5	296
335	G138	8317.5	177	387	G242	7537.5	177	439	G346	6757.5	177
336	G140	8302.5	296	388	G244	7522.5	296	440	G348	6742.5	296
337	G142	8287.5	177	389	G246	7507.5	177	441	G350	6727.5	177
338	G144	8272.5	296	390	G248	7492.5	296	442	G352	6712.5	296
339	G146	8257.5	177	391	G250	7477.5	177	443	G354	6697.5	177
340	G148	8242.5	296	392	G252	7462.5	296	444	G356	6682.5	296
341	G150	8227.5	177	393	G254	7447.5	177	445	G358	6667.5	177
342	G152	8212.5	296	394	G256	7432.5	296	446	G360	6652.5	296
343	G154	8197.5	177	395	G258	7417.5	177	447	G362	6637.5	177
344	G156	8182.5	296	396	G260	7402.5	296	448	G364	6622.5	296
345	G158	8167.5	177	397	G262	7387.5	177	449	G366	6607.5	177
346	G160	8152.5	296	398	G264	7372.5	296	450	G368	6592.5	296
347	G162	8137.5	177	399	G266	7357.5	177	451	G370	6577.5	177
348	G164	8122.5	296	400	G268	7342.5	296	452	G372	6562.5	296
349	G166	8107.5	177	401	G270	7327.5	177	453	G374	6547.5	177
350	G168	8092.5	296	402	G272	7312.5	296	454	G376	6532.5	296
351	G170	8077.5	177	403	G274	7297.5	177	455	G378	6517.5	177
352	G172	8062.5	296	404	G276	7282.5	296	456	G380	6502.5	296
353	G174	8047.5	177	405	G278	7267.5	177	457	G382	6487.5	177
354	G176	8032.5	296	406	G280	7252.5	296	458	G384	6472.5	296
355	G178	8017.5	177	407	G282	7237.5	177	459	G386	6457.5	177
356	G180	8002.5	296	408	G284	7222.5	296	460	G388	6442.5	296
357	G182	7987.5	177	409	G286	7207.5	177	461	G390	6427.5	177
358	G184	7972.5	296	410	G288	7192.5	296	462	G392	6412.5	296

NO.	PAD Name	X	Y	NO.	PAD Name	X	Y	NO.	PAD Name	X	Y
463	G394	6397.5	177	515	S690	5422.5	296	567	S638	4642.5	296
464	G396	6382.5	296	516	S689	5407.5	177	568	S637	4627.5	177
465	G398	6367.5	177	517	S688	5392.5	296	569	S636	4612.5	296
466	G400	6352.5	296	518	S687	5377.5	177	570	S635	4597.5	177
467	G402	6337.5	177	519	S686	5362.5	296	571	S634	4582.5	296
468	G404	6322.5	296	520	S685	5347.5	177	572	S633	4567.5	177
469	G406	6307.5	177	521	S684	5332.5	296	573	S632	4552.5	296
470	G408	6292.5	296	522	S683	5317.5	177	574	S631	4537.5	177
471	G410	6277.5	177	523	S682	5302.5	296	575	S630	4522.5	296
472	G412	6262.5	296	524	S681	5287.5	177	576	S629	4507.5	177
473	G414	6247.5	177	525	S680	5272.5	296	577	S628	4492.5	296
474	G416	6232.5	296	526	S679	5257.5	177	578	S627	4477.5	177
475	G418	6217.5	177	527	S678	5242.5	296	579	S626	4462.5	296
476	G420	6202.5	296	528	S677	5227.5	177	580	S625	4447.5	177
477	G422	6187.5	177	529	S676	5212.5	296	581	S624	4432.5	296
478	G424	6172.5	296	530	S675	5197.5	177	582	S623	4417.5	177
479	G426	6157.5	177	531	S674	5182.5	296	583	S622	4402.5	296
480	G428	6142.5	296	532	S673	5167.5	177	584	S621	4387.5	177
481	G430	6127.5	177	533	S672	5152.5	296	585	S620	4372.5	296
482	G432	6112.5	296	534	S671	5137.5	177	586	S619	4357.5	177
483	VGLDMY2	6097.5	177	535	S670	5122.5	296	587	S618	4342.5	296
484	TESTO5	5887.5	177	536	S669	5107.5	177	588	S617	4327.5	177
485	S720	5872.5	296	537	S668	5092.5	296	589	S616	4312.5	296
486	S719	5857.5	177	538	S667	5077.5	177	590	S615	4297.5	177
487	S718	5842.5	296	539	S666	5062.5	296	591	S614	4282.5	296
488	S717	5827.5	177	540	S665	5047.5	177	592	S613	4267.5	177
489	S716	5812.5	296	541	S664	5032.5	296	593	S612	4252.5	296
490	S715	5797.5	177	542	S663	5017.5	177	594	S611	4237.5	177
491	S714	5782.5	296	543	S662	5002.5	296	595	S610	4222.5	296
492	S713	5767.5	177	544	S661	4987.5	177	596	S609	4207.5	177
493	S712	5752.5	296	545	S660	4972.5	296	597	S608	4192.5	296
494	S711	5737.5	177	546	S659	4957.5	177	598	S607	4177.5	177
495	S710	5722.5	296	547	S658	4942.5	296	599	S606	4162.5	296
496	S709	5707.5	177	548	S657	4927.5	177	600	S605	4147.5	177
497	S708	5692.5	296	549	S656	4912.5	296	601	S604	4132.5	296
498	S707	5677.5	177	550	S655	4897.5	177	602	S603	4117.5	177
499	S706	5662.5	296	551	S654	4882.5	296	603	S602	4102.5	296
500	S705	5647.5	177	552	S653	4867.5	177	604	S601	4087.5	177
501	S704	5632.5	296	553	S652	4852.5	296	605	S600	4072.5	296
502	S703	5617.5	177	554	S651	4837.5	177	606	S599	4057.5	177
503	S702	5602.5	296	555	S650	4822.5	296	607	S598	4042.5	296
504	S701	5587.5	177	556	S649	4807.5	177	608	S597	4027.5	177
505	S700	5572.5	296	557	S648	4792.5	296	609	S596	4012.5	296
506	S699	5557.5	177	558	S647	4777.5	177	610	S595	3997.5	177
507	S698	5542.5	296	559	S646	4762.5	296	611	S594	3982.5	296
508	S697	5527.5	177	560	S645	4747.5	177	612	S593	3967.5	177
509	S696	5512.5	296	561	S644	4732.5	296	613	S592	3952.5	296
510	S695	5497.5	177	562	S643	4717.5	177	614	S591	3937.5	177
511	S694	5482.5	296	563	S642	4702.5	296	615	S590	3922.5	296
512	S693	5467.5	177	564	S641	4687.5	177	616	S589	3907.5	177
513	S692	5452.5	296	565	S640	4672.5	296	617	S588	3892.5	296
514	S691	5437.5	177	566	S639	4657.5	177	618	S587	3877.5	177

NO.	PAD Name	X	Y	NO.	PAD Name	X	Y	NO.	PAD Name	X	Y
619	S586	3862.5	296	671	S534	3082.5	296	723	S482	2302.5	296
620	S585	3847.5	177	672	S533	3067.5	177	724	S481	2287.5	177
621	S584	3832.5	296	673	S532	3052.5	296	725	S480	2272.5	296
622	S583	3817.5	177	674	S531	3037.5	177	726	S479	2257.5	177
623	S582	3802.5	296	675	S530	3022.5	296	727	S478	2242.5	296
624	S581	3787.5	177	676	S529	3007.5	177	728	S477	2227.5	177
625	S580	3772.5	296	677	S528	2992.5	296	729	S476	2212.5	296
626	S579	3757.5	177	678	S527	2977.5	177	730	S475	2197.5	177
627	S578	3742.5	296	679	S526	2962.5	296	731	S474	2182.5	296
628	S577	3727.5	177	680	S525	2947.5	177	732	S473	2167.5	177
629	S576	3712.5	296	681	S524	2932.5	296	733	S472	2152.5	296
630	S575	3697.5	177	682	S523	2917.5	177	734	S471	2137.5	177
631	S574	3682.5	296	683	S522	2902.5	296	735	S470	2122.5	296
632	S573	3667.5	177	684	S521	2887.5	177	736	S469	2107.5	177
633	S572	3652.5	296	685	S520	2872.5	296	737	S468	2092.5	296
634	S571	3637.5	177	686	S519	2857.5	177	738	S467	2077.5	177
635	S570	3622.5	296	687	S518	2842.5	296	739	S466	2062.5	296
636	S569	3607.5	177	688	S517	2827.5	177	740	S465	2047.5	177
637	S568	3592.5	296	689	S516	2812.5	296	741	S464	2032.5	296
638	S567	3577.5	177	690	S515	2797.5	177	742	S463	2017.5	177
639	S566	3562.5	296	691	S514	2782.5	296	743	S462	2002.5	296
640	S565	3547.5	177	692	S513	2767.5	177	744	S461	1987.5	177
641	S564	3532.5	296	693	S512	2752.5	296	745	S460	1972.5	296
642	S563	3517.5	177	694	S511	2737.5	177	746	S459	1957.5	177
643	S562	3502.5	296	695	S510	2722.5	296	747	S458	1942.5	296
644	S561	3487.5	177	696	S509	2707.5	177	748	S457	1927.5	177
645	S560	3472.5	296	697	S508	2692.5	296	749	S456	1912.5	296
646	S559	3457.5	177	698	S507	2677.5	177	750	S455	1897.5	177
647	S558	3442.5	296	699	S506	2662.5	296	751	S454	1882.5	296
648	S557	3427.5	177	700	S505	2647.5	177	752	S453	1867.5	177
649	S556	3412.5	296	701	S504	2632.5	296	753	S452	1852.5	296
650	S555	3397.5	177	702	S503	2617.5	177	754	S451	1837.5	177
651	S554	3382.5	296	703	S502	2602.5	296	755	S450	1822.5	296
652	S553	3367.5	177	704	S501	2587.5	177	756	S449	1807.5	177
653	S552	3352.5	296	705	S500	2572.5	296	757	S448	1792.5	296
654	S551	3337.5	177	706	S499	2557.5	177	758	S447	1777.5	177
655	S550	3322.5	296	707	S498	2542.5	296	759	S446	1762.5	296
656	S549	3307.5	177	708	S497	2527.5	177	760	S445	1747.5	177
657	S548	3292.5	296	709	S496	2512.5	296	761	S444	1732.5	296
658	S547	3277.5	177	710	S495	2497.5	177	762	S443	1717.5	177
659	S546	3262.5	296	711	S494	2482.5	296	763	S442	1702.5	296
660	S545	3247.5	177	712	S493	2467.5	177	764	S441	1687.5	177
661	S544	3232.5	296	713	S492	2452.5	296	765	S440	1672.5	296
662	S543	3217.5	177	714	S491	2437.5	177	766	S439	1657.5	177
663	S542	3202.5	296	715	S490	2422.5	296	767	S438	1642.5	296
664	S541	3187.5	177	716	S489	2407.5	177	768	S437	1627.5	177
665	S540	3172.5	296	717	S488	2392.5	296	769	S436	1612.5	296
666	S539	3157.5	177	718	S487	2377.5	177	770	S435	1597.5	177
667	S538	3142.5	296	719	S486	2362.5	296	771	S434	1582.5	296
668	S537	3127.5	177	720	S485	2347.5	177	772	S433	1567.5	177
669	S536	3112.5	296	721	S484	2332.5	296	773	S432	1552.5	296
670	S535	3097.5	177	722	S483	2317.5	177	774	S431	1537.5	177

NO.	PAD Name	X	Y	NO.	PAD Name	X	Y	NO.	PAD Name	X	Y
775	S430	1522.5	296	827	S378	742.5	296	879	S334	-877.5	296
776	S429	1507.5	177	828	S377	727.5	177	880	S333	-892.5	177
777	S428	1492.5	296	829	S376	712.5	296	881	S332	-907.5	296
778	S427	1477.5	177	830	S375	697.5	177	882	S331	-922.5	177
779	S426	1462.5	296	831	S374	682.5	296	883	S330	-937.5	296
780	S425	1447.5	177	832	S373	667.5	177	884	S329	-952.5	177
781	S424	1432.5	296	833	S372	652.5	296	885	S328	-967.5	296
782	S423	1417.5	177	834	S371	637.5	177	886	S327	-982.5	177
783	S422	1402.5	296	835	S370	622.5	296	887	S326	-997.5	296
784	S421	1387.5	177	836	S369	607.5	177	888	S325	-1012.5	177
785	S420	1372.5	296	837	S368	592.5	296	889	S324	-1027.5	296
786	S419	1357.5	177	838	S367	577.5	177	890	S323	-1042.5	177
787	S418	1342.5	296	839	S366	562.5	296	891	S322	-1057.5	296
788	S417	1327.5	177	840	S365	547.5	177	892	S321	-1072.5	177
789	S416	1312.5	296	841	S364	532.5	296	893	S320	-1087.5	296
790	S415	1297.5	177	842	S363	517.5	177	894	S319	-1102.5	177
791	S414	1282.5	296	843	S362	502.5	296	895	S318	-1117.5	296
792	S413	1267.5	177	844	S361	487.5	177	896	S317	-1132.5	177
793	S412	1252.5	296	845	TESTO6	472.5	296	897	S316	-1147.5	296
794	S411	1237.5	177	846	TESTO7	457.5	177	898	S315	-1162.5	177
795	S410	1222.5	296	847	TESTO8	442.5	296	899	S314	-1177.5	296
796	S409	1207.5	177	848	TESTO9	427.5	177	900	S313	-1192.5	177
797	S408	1192.5	296	849	TESTO10	-427.5	296	901	S312	-1207.5	296
798	S407	1177.5	177	850	TESTO11	-442.5	177	902	S311	-1222.5	177
799	S406	1162.5	296	851	TESTO12	-457.5	296	903	S310	-1237.5	296
800	S405	1147.5	177	852	TESTO13	-472.5	177	904	S309	-1252.5	177
801	S404	1132.5	296	853	S360	-487.5	296	905	S308	-1267.5	296
802	S403	1117.5	177	854	S359	-502.5	177	906	S307	-1282.5	177
803	S402	1102.5	296	855	S358	-517.5	296	907	S306	-1297.5	296
804	S401	1087.5	177	856	S357	-532.5	177	908	S305	-1312.5	177
805	S400	1072.5	296	857	S356	-547.5	296	909	S304	-1327.5	296
806	S399	1057.5	177	858	S355	-562.5	177	910	S303	-1342.5	177
807	S398	1042.5	296	859	S354	-577.5	296	911	S302	-1357.5	296
808	S397	1027.5	177	860	S353	-592.5	177	912	S301	-1372.5	177
809	S396	1012.5	296	861	S352	-607.5	296	913	S300	-1387.5	296
810	S395	997.5	177	862	S351	-622.5	177	914	S299	-1402.5	177
811	S394	982.5	296	863	S350	-637.5	296	915	S298	-1417.5	296
812	S393	967.5	177	864	S349	-652.5	177	916	S297	-1432.5	177
813	S392	952.5	296	865	S348	-667.5	296	917	S296	-1447.5	296
814	S391	937.5	177	866	S347	-682.5	177	918	S295	-1462.5	177
815	S390	922.5	296	867	S346	-697.5	296	919	S294	-1477.5	296
816	S389	907.5	177	868	S345	-712.5	177	920	S293	-1492.5	177
817	S388	892.5	296	869	S344	-727.5	296	921	S292	-1507.5	296
818	S387	877.5	177	870	S343	-742.5	177	922	S291	-1522.5	177
819	S386	862.5	296	871	S342	-757.5	296	923	S290	-1537.5	296
820	S385	847.5	177	872	S341	-772.5	177	924	S289	-1552.5	177
821	S384	832.5	296	873	S340	-787.5	296	925	S288	-1567.5	296
822	S383	817.5	177	874	S339	-802.5	177	926	S287	-1582.5	177
823	S382	802.5	296	875	S338	-817.5	296	927	S286	-1597.5	296
824	S381	787.5	177	876	S337	-832.5	177	928	S285	-1612.5	177
825	S380	772.5	296	877	S336	-847.5	296	929	S284	-1627.5	296
826	S379	757.5	177	878	S335	-862.5	177	930	S283	-1642.5	177

NO.	PAD Name	X	Y	NO.	PAD Name	X	Y	NO.	PAD Name	X	Y
931	S282	-1657.5	296	983	S230	-2437.5	296	1035	S178	-3217.5	296
932	S281	-1672.5	177	984	S229	-2452.5	177	1036	S177	-3232.5	177
933	S280	-1687.5	296	985	S228	-2467.5	296	1037	S176	-3247.5	296
934	S279	-1702.5	177	986	S227	-2482.5	177	1038	S175	-3262.5	177
935	S278	-1717.5	296	987	S226	-2497.5	296	1039	S174	-3277.5	296
936	S277	-1732.5	177	988	S225	-2512.5	177	1040	S173	-3292.5	177
937	S276	-1747.5	296	989	S224	-2527.5	296	1041	S172	-3307.5	296
938	S275	-1762.5	177	990	S223	-2542.5	177	1042	S171	-3322.5	177
939	S274	-1777.5	296	991	S222	-2557.5	296	1043	S170	-3337.5	296
940	S273	-1792.5	177	992	S221	-2572.5	177	1044	S169	-3352.5	177
941	S272	-1807.5	296	993	S220	-2587.5	296	1045	S168	-3367.5	296
942	S271	-1822.5	177	994	S219	-2602.5	177	1046	S167	-3382.5	177
943	S270	-1837.5	296	995	S218	-2617.5	296	1047	S166	-3397.5	296
944	S269	-1852.5	177	996	S217	-2632.5	177	1048	S165	-3412.5	177
945	S268	-1867.5	296	997	S216	-2647.5	296	1049	S164	-3427.5	296
946	S267	-1882.5	177	998	S215	-2662.5	177	1050	S163	-3442.5	177
947	S266	-1897.5	296	999	S214	-2677.5	296	1051	S162	-3457.5	296
948	S265	-1912.5	177	1000	S213	-2692.5	177	1052	S161	-3472.5	177
949	S264	-1927.5	296	1001	S212	-2707.5	296	1053	S160	-3487.5	296
950	S263	-1942.5	177	1002	S211	-2722.5	177	1054	S159	-3502.5	177
951	S262	-1957.5	296	1003	S210	-2737.5	296	1055	S158	-3517.5	296
952	S261	-1972.5	177	1004	S209	-2752.5	177	1056	S157	-3532.5	177
953	S260	-1987.5	296	1005	S208	-2767.5	296	1057	S156	-3547.5	296
954	S259	-2002.5	177	1006	S207	-2782.5	177	1058	S155	-3562.5	177
955	S258	-2017.5	296	1007	S206	-2797.5	296	1059	S154	-3577.5	296
956	S257	-2032.5	177	1008	S205	-2812.5	177	1060	S153	-3592.5	177
957	S256	-2047.5	296	1009	S204	-2827.5	296	1061	S152	-3607.5	296
958	S255	-2062.5	177	1010	S203	-2842.5	177	1062	S151	-3622.5	177
959	S254	-2077.5	296	1011	S202	-2857.5	296	1063	S150	-3637.5	296
960	S253	-2092.5	177	1012	S201	-2872.5	177	1064	S149	-3652.5	177
961	S252	-2107.5	296	1013	S200	-2887.5	296	1065	S148	-3667.5	296
962	S251	-2122.5	177	1014	S199	-2902.5	177	1066	S147	-3682.5	177
963	S250	-2137.5	296	1015	S198	-2917.5	296	1067	S146	-3697.5	296
964	S249	-2152.5	177	1016	S197	-2932.5	177	1068	S145	-3712.5	177
965	S248	-2167.5	296	1017	S196	-2947.5	296	1069	S144	-3727.5	296
966	S247	-2182.5	177	1018	S195	-2962.5	177	1070	S143	-3742.5	177
967	S246	-2197.5	296	1019	S194	-2977.5	296	1071	S142	-3757.5	296
968	S245	-2212.5	177	1020	S193	-2992.5	177	1072	S141	-3772.5	177
969	S244	-2227.5	296	1021	S192	-3007.5	296	1073	S140	-3787.5	296
970	S243	-2242.5	177	1022	S191	-3022.5	177	1074	S139	-3802.5	177
971	S242	-2257.5	296	1023	S190	-3037.5	296	1075	S138	-3817.5	296
972	S241	-2272.5	177	1024	S189	-3052.5	177	1076	S137	-3832.5	177
973	S240	-2287.5	296	1025	S188	-3067.5	296	1077	S136	-3847.5	296
974	S239	-2302.5	177	1026	S187	-3082.5	177	1078	S135	-3862.5	177
975	S238	-2317.5	296	1027	S186	-3097.5	296	1079	S134	-3877.5	296
976	S237	-2332.5	177	1028	S185	-3112.5	177	1080	S133	-3892.5	177
977	S236	-2347.5	296	1029	S184	-3127.5	296	1081	S132	-3907.5	296
978	S235	-2362.5	177	1030	S183	-3142.5	177	1082	S131	-3922.5	177
979	S234	-2377.5	296	1031	S182	-3157.5	296	1083	S130	-3937.5	296
980	S233	-2392.5	177	1032	S181	-3172.5	177	1084	S129	-3952.5	177
981	S232	-2407.5	296	1033	S180	-3187.5	296	1085	S128	-3967.5	296
982	S231	-2422.5	177	1034	S179	-3202.5	177	1086	S127	-3982.5	177

NO.	PAD Name	X	Y	NO.	PAD Name	X	Y	NO.	PAD Name	X	Y
1087	S126	-3997.5	296	1139	S74	-4777.5	296	1191	S22	-5557.5	296
1088	S125	-4012.5	177	1140	S73	-4792.5	177	1192	S21	-5572.5	177
1089	S124	-4027.5	296	1141	S72	-4807.5	296	1193	S20	-5587.5	296
1090	S123	-4042.5	177	1142	S71	-4822.5	177	1194	S19	-5602.5	177
1091	S122	-4057.5	296	1143	S70	-4837.5	296	1195	S18	-5617.5	296
1092	S121	-4072.5	177	1144	S69	-4852.5	177	1196	S17	-5632.5	177
1093	S120	-4087.5	296	1145	S68	-4867.5	296	1197	S16	-5647.5	296
1094	S119	-4102.5	177	1146	S67	-4882.5	177	1198	S15	-5662.5	177
1095	S118	-4117.5	296	1147	S66	-4897.5	296	1199	S14	-5677.5	296
1096	S117	-4132.5	177	1148	S65	-4912.5	177	1200	S13	-5692.5	177
1097	S116	-4147.5	296	1149	S64	-4927.5	296	1201	S12	-5707.5	296
1098	S115	-4162.5	177	1150	S63	-4942.5	177	1202	S11	-5722.5	177
1099	S114	-4177.5	296	1151	S62	-4957.5	296	1203	S10	-5737.5	296
1100	S113	-4192.5	177	1152	S61	-4972.5	177	1204	S9	-5752.5	177
1101	S112	-4207.5	296	1153	S60	-4987.5	296	1205	S8	-5767.5	296
1102	S111	-4222.5	177	1154	S59	-5002.5	177	1206	S7	-5782.5	177
1103	S110	-4237.5	296	1155	S58	-5017.5	296	1207	S6	-5797.5	296
1104	S109	-4252.5	177	1156	S57	-5032.5	177	1208	S5	-5812.5	177
1105	S108	-4267.5	296	1157	S56	-5047.5	296	1209	S4	-5827.5	296
1106	S107	-4282.5	177	1158	S55	-5062.5	177	1210	S3	-5842.5	177
1107	S106	-4297.5	296	1159	S54	-5077.5	296	1211	S2	-5857.5	296
1108	S105	-4312.5	177	1160	S53	-5092.5	177	1212	S1	-5872.5	177
1109	S104	-4327.5	296	1161	S52	-5107.5	296	1213	TESTO14	-5887.5	296
1110	S103	-4342.5	177	1162	S51	-5122.5	177	1214	VGLDMY3	-6097.5	296
1111	S102	-4357.5	296	1163	S50	-5137.5	296	1215	G431	-6112.5	177
1112	S101	-4372.5	177	1164	S49	-5152.5	177	1216	G429	-6127.5	296
1113	S100	-4387.5	296	1165	S48	-5167.5	296	1217	G427	-6142.5	177
1114	S99	-4402.5	177	1166	S47	-5182.5	177	1218	G425	-6157.5	296
1115	S98	-4417.5	296	1167	S46	-5197.5	296	1219	G423	-6172.5	177
1116	S97	-4432.5	177	1168	S45	-5212.5	177	1220	G421	-6187.5	296
1117	S96	-4447.5	296	1169	S44	-5227.5	296	1221	G419	-6202.5	177
1118	S95	-4462.5	177	1170	S43	-5242.5	177	1222	G417	-6217.5	296
1119	S94	-4477.5	296	1171	S42	-5257.5	296	1223	G415	-6232.5	177
1120	S93	-4492.5	177	1172	S41	-5272.5	177	1224	G413	-6247.5	296
1121	S92	-4507.5	296	1173	S40	-5287.5	296	1225	G411	-6262.5	177
1122	S91	-4522.5	177	1174	S39	-5302.5	177	1226	G409	-6277.5	296
1123	S90	-4537.5	296	1175	S38	-5317.5	296	1227	G407	-6292.5	177
1124	S89	-4552.5	177	1176	S37	-5332.5	177	1228	G405	-6307.5	296
1125	S88	-4567.5	296	1177	S36	-5347.5	296	1229	G403	-6322.5	177
1126	S87	-4582.5	177	1178	S35	-5362.5	177	1230	G401	-6337.5	296
1127	S86	-4597.5	296	1179	S34	-5377.5	296	1231	G399	-6352.5	177
1128	S85	-4612.5	177	1180	S33	-5392.5	177	1232	G397	-6367.5	296
1129	S84	-4627.5	296	1181	S32	-5407.5	296	1233	G395	-6382.5	177
1130	S83	-4642.5	177	1182	S31	-5422.5	177	1234	G393	-6397.5	296
1131	S82	-4657.5	296	1183	S30	-5437.5	296	1235	G391	-6412.5	177
1132	S81	-4672.5	177	1184	S29	-5452.5	177	1236	G389	-6427.5	296
1133	S80	-4687.5	296	1185	S28	-5467.5	296	1237	G387	-6442.5	177
1134	S79	-4702.5	177	1186	S27	-5482.5	177	1238	G385	-6457.5	296
1135	S78	-4717.5	296	1187	S26	-5497.5	296	1239	G383	-6472.5	177
1136	S77	-4732.5	177	1188	S25	-5512.5	177	1240	G381	-6487.5	296
1137	S76	-4747.5	296	1189	S24	-5527.5	296	1241	G379	-6502.5	177
1138	S75	-4762.5	177	1190	S23	-5542.5	177	1242	G377	-6517.5	296

NO.	PAD Name	X	Y	NO.	PAD Name	X	Y	NO.	PAD Name	X	Y
1243	G375	-6532.5	177	1295	G271	-7312.5	177	1347	G167	-8092.5	177
1244	G373	-6547.5	296	1296	G269	-7327.5	296	1348	G165	-8107.5	296
1245	G371	-6562.5	177	1297	G267	-7342.5	177	1349	G163	-8122.5	177
1246	G369	-6577.5	296	1298	G265	-7357.5	296	1350	G161	-8137.5	296
1247	G367	-6592.5	177	1299	G263	-7372.5	177	1351	G159	-8152.5	177
1248	G365	-6607.5	296	1300	G261	-7387.5	296	1352	G157	-8167.5	296
1249	G363	-6622.5	177	1301	G259	-7402.5	177	1353	G155	-8182.5	177
1250	G361	-6637.5	296	1302	G257	-7417.5	296	1354	G153	-8197.5	296
1251	G359	-6652.5	177	1303	G255	-7432.5	177	1355	G151	-8212.5	177
1252	G357	-6667.5	296	1304	G253	-7447.5	296	1356	G149	-8227.5	296
1253	G355	-6682.5	177	1305	G251	-7462.5	177	1357	G147	-8242.5	177
1254	G353	-6697.5	296	1306	G249	-7477.5	296	1358	G145	-8257.5	296
1255	G351	-6712.5	177	1307	G247	-7492.5	177	1359	G143	-8272.5	177
1256	G349	-6727.5	296	1308	G245	-7507.5	296	1360	G141	-8287.5	296
1257	G347	-6742.5	177	1309	G243	-7522.5	177	1361	G139	-8302.5	177
1258	G345	-6757.5	296	1310	G241	-7537.5	296	1362	G137	-8317.5	296
1259	G343	-6772.5	177	1311	G239	-7552.5	177	1363	G135	-8332.5	177
1260	G341	-6787.5	296	1312	G237	-7567.5	296	1364	G133	-8347.5	296
1261	G339	-6802.5	177	1313	G235	-7582.5	177	1365	G131	-8362.5	177
1262	G337	-6817.5	296	1314	G233	-7597.5	296	1366	G129	-8377.5	296
1263	G335	-6832.5	177	1315	G231	-7612.5	177	1367	G127	-8392.5	177
1264	G333	-6847.5	296	1316	G229	-7627.5	296	1368	G125	-8407.5	296
1265	G331	-6862.5	177	1317	G227	-7642.5	177	1369	G123	-8422.5	177
1266	G329	-6877.5	296	1318	G225	-7657.5	296	1370	G121	-8437.5	296
1267	G327	-6892.5	177	1319	G223	-7672.5	177	1371	G119	-8452.5	177
1268	G325	-6907.5	296	1320	G221	-7687.5	296	1372	G117	-8467.5	296
1269	G323	-6922.5	177	1321	G219	-7702.5	177	1373	G115	-8482.5	177
1270	G321	-6937.5	296	1322	G217	-7717.5	296	1374	G113	-8497.5	296
1271	G319	-6952.5	177	1323	G215	-7732.5	177	1375	G111	-8512.5	177
1272	G317	-6967.5	296	1324	G213	-7747.5	296	1376	G109	-8527.5	296
1273	G315	-6982.5	177	1325	G211	-7762.5	177	1377	G107	-8542.5	177
1274	G313	-6997.5	296	1326	G209	-7777.5	296	1378	G105	-8557.5	296
1275	G311	-7012.5	177	1327	G207	-7792.5	177	1379	G103	-8572.5	177
1276	G309	-7027.5	296	1328	G205	-7807.5	296	1380	G101	-8587.5	296
1277	G307	-7042.5	177	1329	G203	-7822.5	177	1381	G99	-8602.5	177
1278	G305	-7057.5	296	1330	G201	-7837.5	296	1382	G97	-8617.5	296
1279	G303	-7072.5	177	1331	G199	-7852.5	177	1383	G95	-8632.5	177
1280	G301	-7087.5	296	1332	G197	-7867.5	296	1384	G93	-8647.5	296
1281	G299	-7102.5	177	1333	G195	-7882.5	177	1385	G91	-8662.5	177
1282	G297	-7117.5	296	1334	G193	-7897.5	296	1386	G89	-8677.5	296
1283	G295	-7132.5	177	1335	G191	-7912.5	177	1387	G87	-8692.5	177
1284	G293	-7147.5	296	1336	G189	-7927.5	296	1388	G85	-8707.5	296
1285	G291	-7162.5	177	1337	G187	-7942.5	177	1389	G83	-8722.5	177
1286	G289	-7177.5	296	1338	G185	-7957.5	296	1390	G81	-8737.5	296
1287	G287	-7192.5	177	1339	G183	-7972.5	177	1391	G79	-8752.5	177
1288	G285	-7207.5	296	1340	G181	-7987.5	296	1392	G77	-8767.5	296
1289	G283	-7222.5	177	1341	G179	-8002.5	177	1393	G75	-8782.5	177
1290	G281	-7237.5	296	1342	G177	-8017.5	296	1394	G73	-8797.5	296
1291	G279	-7252.5	177	1343	G175	-8032.5	177	1395	G71	-8812.5	177
1292	G277	-7267.5	296	1344	G173	-8047.5	296	1396	G69	-8827.5	296
1293	G275	-7282.5	177	1345	G171	-8062.5	177	1397	G67	-8842.5	177
1294	G273	-7297.5	296	1346	G169	-8077.5	296	1398	G65	-8857.5	296

NO.	PAD Name	X	Y
1399	G63	-8872.5	177
1400	G61	-8887.5	296
1401	G59	-8902.5	177
1402	G57	-8917.5	296
1403	G55	-8932.5	177
1404	G53	-8947.5	296
1405	G51	-8962.5	177
1406	G49	-8977.5	296
1407	G47	-8992.5	177
1408	G45	-9007.5	296
1409	G43	-9022.5	177
1410	G41	-9037.5	296
1411	G39	-9052.5	177

NO.	PAD Name	X	Y
1412	G37	-9067.5	296
1413	G35	-9082.5	177
1414	G33	-9097.5	296
1415	G31	-9112.5	177
1416	G29	-9127.5	296
1417	G27	-9142.5	177
1418	G25	-9157.5	296
1419	G23	-9172.5	177
1420	G21	-9187.5	296
1421	G19	-9202.5	177
1422	G17	-9217.5	296
1423	G15	-9232.5	177
1424	G13	-9247.5	296

NO.	PAD Name	X	Y
1425	G11	-9262.5	177
1426	G9	-9277.5	296
1427	G7	-9292.5	177
1428	G5	-9307.5	296
1429	G3	-9322.5	177
1430	G1	-9337.5	296
1431	VGLDMY4	-9352.5	177
1432	TESTO15	-9367.5	296
1433	DUMMYR3	-9382.5	177
1434	DUMMYR4	-9397.5	296

14.5. Alignment Mark

--Alignment Mark coordinate

Left (-9381, -231)

Right (9381, -231)

--Alignment Mark size

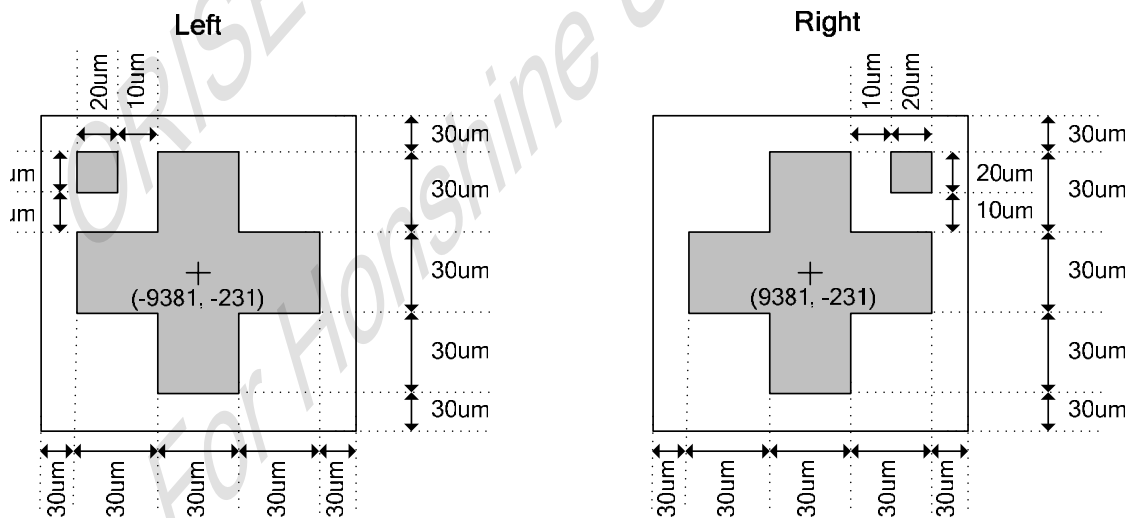

15. COG PRODUCTS MANUFACTURING GUIDELINES

15.1. Purpose:

The purpose of this specification is to identify ACF bonding process, so that customers can use properly ACF and Chip during the assembly.

15.2. Scope:

ACF bonding process

15.3. Noun definition

15.3.1. COG: Chip on Glass

15.3.2. ACF (Anisotropic Conductive Film): .ACF is a functional adhesive tape which is able to connect (conductivity, adhesion, insulation) multiterminals in one time.

15.3.3. CTE: Coefficient of thermal expansion

15.4. Responsibility unity:

ORISETECH Quality Assurance unity

15.5. Contents:

15.5.1. Applicable documents

IPC-SM-782: Surface Mount Design & Land Pattern Standard

IPC-7351 Generic Requirements for Surface Mount Design and Land Pattern Standard.

IPC JEDEC: J-STD-033A Standard for Handling, Packing, Shipping and Use of Moisture/Reflow Sensitive Surface Mount Devices

JESD22-B111: Board Level Drop Test of Components for Handheld Electronic Products

IPC-A-610: Acceptability of Electronic Assemblies

15.5.2. ACF Characteristics:

10.5.2.1 Three factors to achieve the connection: Temperature, Pressure, Time.

15.5.3. ACF process :

10.5.3.1 To use Low Temperature and Low stress ACF is recommended for thin chip as 300 um.

10.5.3.2 Warp issues may happen if customers do not use Low Temperature and Low stress ACF for long chip .And warp issues may induce chip broken after ACF bonding for the CTE mismatch of Glass and ACF and Chip.

10.5.3.3 To use 3um ACF is recommended for BUMP space is less than 13um.

10.5.3.4 To use Low temperature and long time bonding is recommended if delamination happens in edge of chip.

10.5.3.5 For fine pitch and thin chip (300 um) products, customer should review

ACF bonding condition with ACF maker.

15.6. References:

*IPC:

<http://www.ipc.org>

*HDPUG (High Density Package Users Group)

<http://www.hdpug.org>

*JEDEC (Joint Electronic Device Engineering Council)

<http://www.jedec.org>

*JEITA (Japan Electronic Industry Association)

<http://www.jeita.org>



16. DISCLAIMER

The information appearing in this publication is believed to be accurate.

Integrated circuits sold by ORISE Technology are covered by the warranty and patent indemnification provisions stipulated in the terms of sale only. ORISE Technology makes no warranty, express, statutory implied or by description regarding the information in this publication or regarding the freedom of the described chip(s) from patent infringement. FURTHERMORE, ORISE Technology MAKES NO WARRANTY OF MERCHANTABILITY OR FITNESS FOR ANY PURPOSE. ORISE Technology reserves the right to halt production or alter the specifications and prices at any time without notice. Accordingly, the reader is cautioned to verify that the data sheets and other information in this publication are current before placing orders. Products described herein are intended for use in normal commercial applications. Applications involving unusual environmental or reliability requirements, e.g. military equipment or medical life support equipment, are specifically not recommended without additional processing by ORISE Technology for such applications. Please note that application circuits illustrated in this document are for reference purposes only.

ORISE Tech Confidential
For Honshine Use Only

17. REVISION HISTORY

Date	Revision #	Description	Page
OCT. 01, 2009	0.3	1. Revise block diagram.	6
		2. Revise charge pump and power supply signal description.	9
		3. Revise misc. signal description.	10
		4. Remove SM setting.	14
		5. Revise Table 6-7	16
		6. Revise Table 6-21, RTNE setting fix error.	22-23
		7. Revise Table 6-28, AP[2:0] setting value.	29
		8. Revise Table 6-29, summarized the function of BT2-0 setting	29
		9. Rename VCIOUT to VCI1	30
		10. Revise DC12-10 setting and DC 02-00 setting.	30
		11. Remove commands R107h , R110h	33
		12. Revise chapter 10 "Power management system "	61-63
		13. Revise chapter 11 "Application circuit "	64
		14. Revise Power off sequence diagram.	73
		15. Revise chip size, bump hardness and bump height.	81
		16. Revise dummy pad name.	82
AUG. 05, 2009	0.2	Add CABC function	25-27
APR. 07, 2009	0.1	Original	89