

# Ultra High Dynamic Range Monolithic Amplifier

## PHA-1+

50Ω 0.05 to 6 GHz

### The Big Deal

- Ultra High IP3
- Broadband High Dynamic Range without external Matching Components
- May be used as a replacement to WJ AH1<sup>a,b</sup>



SOT-89 PACKAGE

- LTE Performance
- TD-SCDMA Performance

### Product Overview

PHA-1+ (RoHS compliant) is an advanced wideband amplifier fabricated using E-PHEMT technology and offers extremely high dynamic range over a broad frequency range and with low noise figure. In addition, the PHA-1+, unlike competitive models, has good input and output return loss over a broad frequency range without the need for external matching components and has demonstrated excellent reliability. Lead finish is SnAgNi. It has repeatable performance from lot to lot and is enclosed in a SOT-89 package for very good thermal performance.

### Key Features

Feature	Advantages
Broad Band: 0.05 to 6.0 GHz	Broadband covering primary wireless communications bands: Cellular, PCS, LTE, WiMAX
Extremely High IP3 Versus DC power Consumption 42 dBm typical at 2 GHz	The PHA-1+ matches industry leading IP3 performance relative to device size and power consumption. The combination of the design and E-PHEMT Structure provides enhanced linearity over a broad frequency range as evidence in the IP3 being typically 20 dB above the P 1dB point. This feature makes this amplifier ideal for use in: <ul style="list-style-type: none"> <li>• Driver amplifiers for complex waveform up converter paths</li> <li>• Drivers in linearized transmit systems</li> <li>• Secondary amplifiers in ultra High Dynamic range receivers</li> </ul>
No External Matching Components Required	Unlike competing products, Mini-Circuits PHA-1+ provides Input and Output Return Loss of 14-21 dB up to 4 GHz without the need for any external matching components
Low Noise Figure: 2.3dB typ. up to 4 GHz 3.5dB typ. up to 6 GHz	A unique feature of the PHA-1+ which separates this design from all competitors is the low noise figure performance in combination with the high dynamic range.

Notes:

a. Suitability for model replacement within a particular system must be determined by and is solely the responsibility of the customer based on, among other things, electrical performance criteria, stimulus conditions, application, compatibility with other components and environmental conditions and stresses.

b. The WJ AH1 part number is used for identification and comparison purposes only.

\* X-parameters is a registered trademark of Agilent Technologies, Inc. The X-parameters format and underlying equations are open and documented. For more information, refer to [X-parameters Open Documentation, Trademark Usage & Partnerships](#)

Notes

- A. Performance and quality attributes and conditions not expressly stated in this specification document are intended to be excluded and do not form a part of this specification document.
- B. Electrical specifications and performance data contained in this specification document are based on Mini-Circuit's applicable established test performance criteria and measurement instructions.
- C. The parts covered by this specification document are subject to Mini-Circuits standard limited warranty and terms and conditions (collectively, "Standard Terms"); Purchasers of this part are entitled to the rights and benefits contained therein. For a full statement of the Standard Terms and the exclusive rights and remedies thereunder, please visit Mini-Circuits' website at [www.minicircuits.com/MCLStore/terms.jsp](http://www.minicircuits.com/MCLStore/terms.jsp)



Low Noise, High IP3

# Monolithic Amplifier

0.05-6 GHz

## Product Features

- High IP3, 42 dBm typ. at 2 GHz, 5V
- Gain, 13.5 dB typ. at 2 GHz, 5V
- High Pout, P1dB 22 dBm typ. at 2 GHz, 5V
- Low noise figure, 2.2 dB @2 GHz, 5V
- Usable to 4.0V
- No external matching components required
- May be used as replacement for WJ AH1<sup>a,b</sup>

## Typical Applications

- Base station infrastructure
- Portable Wireless
- CATV & DBS
- MMDS & Wireless LAN
- LTE



## PHA-1+

CASE STYLE: DF782  
PRICE: \$1.49 ea. QTY. (50)

**+RoHS Compliant**  
The +Suffix identifies RoHS Compliance. See our web site for RoHS Compliance methodologies and qualifications

- LTE Performance
- TD-SCDMA Performance

## General Description

PHA-1+ (RoHS compliant) is an advanced wideband amplifier fabricated using E-PHEMT technology and offers extremely high dynamic range over a broad frequency range and with low noise figure. In addition, the PHA-1+ has good input and output return loss over a broad frequency range without the need for external matching components. Lead finish is SnAgNi. It has repeatable performance from lot to lot and is enclosed in a SOT-89 package for very good thermal performance.

## simplified schematic and pin description

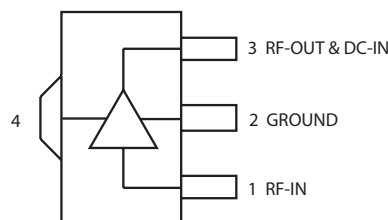
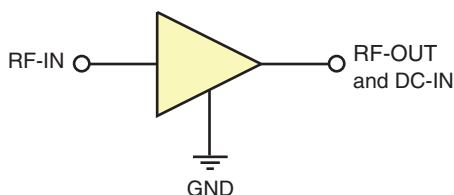

Function	Pin Number	Description
RF IN	1	RF input pin. This pin requires the use of an external DC blocking capacitor chosen for the frequency of operation.
RF-OUT and DC-IN	3	RF output and bias pin. DC voltage is present on this pin; therefore a DC blocking capacitor is necessary for proper operation. An RF choke is needed to feed DC bias without loss of RF signal due to the bias connection, as shown in "Recommended Application Circuit", Fig. 2
GND	2,4	Connections to ground. Use via holes as shown in "Suggested Layout for PCB Design" to reduce ground path inductance for best performance.

### Notes:

- Suitability for model replacement within a particular system must be determined by and is solely the responsibility of the customer based on, among other things, electrical performance criteria, stimulus conditions, application, compatibility with other components and environmental conditions and stresses.
- The WJ AH1 part number is used for identification and comparison purposes only.

### Notes

- Performance and quality attributes and conditions not expressly stated in this specification document are intended to be excluded and do not form a part of this specification document.
- Electrical specifications and performance data contained in this specification document are based on Mini-Circuit's applicable established test performance criteria and measurement instructions.
- The parts covered by this specification document are subject to Mini-Circuits standard limited warranty and terms and conditions (collectively, "Standard Terms"); Purchasers of this part are entitled to the rights and benefits contained therein. For a full statement of the Standard Terms and the exclusive rights and remedies thereunder, please visit Mini-Circuits' website at [www.minicircuits.com/MCLStore/terms.jsp](http://www.minicircuits.com/MCLStore/terms.jsp)



Electrical Specifications at 25°C, unless noted

Parameter	Condition (GHz)	Vd=5.0V <sup>(1)</sup>			Vd=4.5V <sup>(2)</sup>	Vd=4.0V <sup>(2)</sup>	Units
		Min.	Typ.	Max.	Typ.	Typ.	
Frequency Range		0.05		6	0.05-6	0.05-6	GHz
Gain	0.05	15.4	17.2	19.4	17.5	17.3	dB
	0.8	14.1	15.7	17.3	15.5	15.2	
	2.0		13.5		13.4	13.1	
	3.0		11.8		11.8	11.4	
	4.0	9.6	10.7	12.3	10.7	10.4	
Input Return Loss	0.05		11.7		10.7	10.6	dB
	0.8	13.0	17.0		16.5	16.1	
	2.0		11.3		11.7	11.4	
	3.0		10.2		10.4	10.1	
	4.0		10.2		9.7	9.5	
Output Return Loss	0.05		14.5		13.7	13.5	dB
	0.8	13.0	20.8		19.5	18.3	
	2.0		17.1		16.1	14.7	
	3.0		15.3		14.1	13.4	
	4.0		13.8		12.8	12.2	
Reverse Isolation	0.05		19.9		19.3	18.9	dB
	0.8		19.9		19.3	18.9	
	2.0		19.9		19.3	18.9	
	3.0		19.9		19.3	18.9	
	4.0		19.9		19.3	18.9	
Output Power @ 1 dB compression	0.05	20.0	22.2		21.5	20.0	dBm
	0.8	20.0	22.6		21.3	19.9	
	2.0	20.0	22.4		21.4	19.9	
	3.0		22.7		21.6	20.1	
	4.0		22.7		21.5	20.1	
Output IP3	0.05		41.4		36.8	34.4	dBm
	0.8	37.0	41.1		40.0	36.3	
	2.0		42.0		37.1	34.0	
	3.0		42.3		36.3	33.3	
	4.0		40.8		35.8	32.7	
Noise Figure	0.05		1.7		1.9	1.8	dB
	1.0		1.9		2.3	2.1	
	2.0		2.2		2.4	2.2	
	3.0		2.3		2.5	2.5	
	4.0		2.7		3.0	2.9	
Device Operating Voltage	0.05	4.8	5.0	5.2	4.5	4.0	V
	0.8	4.8	5.0	5.2	4.5	4.0	
	2.0	4.8	5.0	5.2	4.5	4.0	
	3.0	4.8	5.0	5.2	4.5	4.0	
	4.0	4.8	5.0	5.2	4.5	4.0	
Device Operating Current	0.05	110	146	180	119	95	mA
	0.8	110	146	180	119	95	
	2.0	110	146	180	119	95	
	3.0	110	146	180	119	95	
	4.0	110	146	180	119	95	
Device Current Variation vs. Temperature <sup>(3)</sup>	0.05		-12		68	67	µA/°C
	0.8		-12		68	67	
	2.0		-12		68	67	
	3.0		-12		68	67	
	4.0		-12		68	67	
Device Current Variation vs Voltage	0.05		0.054		0.052	0.052	mA/mV
	0.8		0.054		0.052	0.052	
	2.0		0.054		0.052	0.052	
	3.0		0.054		0.052	0.052	
	4.0		0.054		0.052	0.052	
Thermal Resistance, junction-to-ground lead	0.05		60		60	60	°C/W
	0.8		60		60	60	
	2.0		60		60	60	
	3.0		60		60	60	
	4.0		60		60	60	

<sup>(1)</sup> Measured on Mini-Circuits Characterization test board TB-313. See Characterization Test Circuit (Fig. 1)

<sup>(2)</sup> Measured on Mini-Circuits test fixture 90-6-20-26 characterization Circuit (Fig.1), except replace TB-313 with 90-6-20-26

<sup>(3)</sup> (Current at 85°C — Current at -45°C)/130

Absolute Maximum Ratings

Parameter	Ratings
Operating Temperature (ground lead)	-40°C to 85°C
Storage Temperature	-65°C to 150°C
Operating Current at 5V	210 mA
Power Dissipation	1 W
Input Power (CW)	24 dBm
DC Voltage on Pin 3	6 V

Note:

Permanent damage may occur if any of these limits are exceeded.

Electrical maximum ratings are not intended for continuous normal operation.

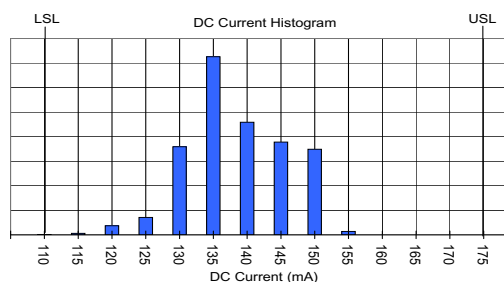

Notes

- A. Performance and quality attributes and conditions not expressly stated in this specification document are intended to be excluded and do not form a part of this specification document.
- B. Electrical specifications and performance data contained in this specification document are based on Mini-Circuit's applicable established test performance criteria and measurement instructions.
- C. The parts covered by this specification document are subject to Mini-Circuits standard limited warranty and terms and conditions (collectively, "Standard Terms"); Purchasers of this part are entitled to the rights and benefits contained therein. For a full statement of the Standard Terms and the exclusive rights and remedies thereunder, please visit Mini-Circuits' website at [www.minicircuits.com/MCLStore/terms.jsp](http://www.minicircuits.com/MCLStore/terms.jsp)

### Characterization Test Circuit

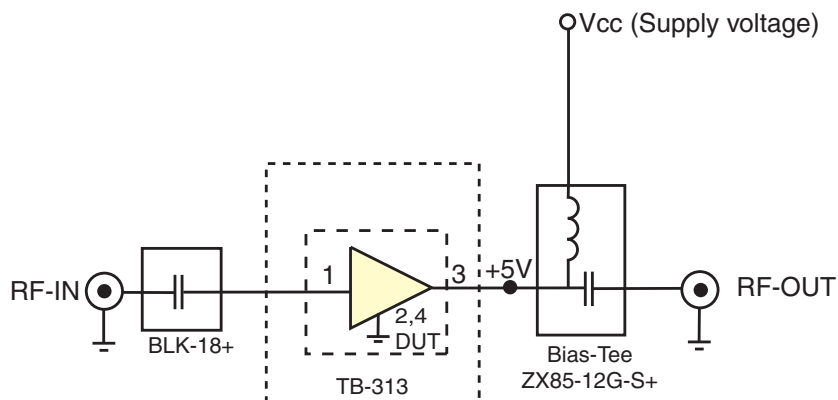
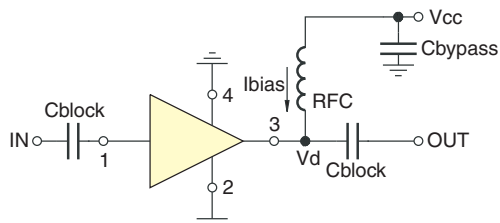

**Fig 1.** Block Diagram of Test Circuit used for characterization. (DUT soldered on Mini-Circuits Characterization test board TB-313)  
Gain, Return loss, Output power at 1dB compression (P1 dB) , output IP3 (OIP3) and noise figure measured using Agilent’s N5242A PNA-X microwave network analyzer.

**Conditions:**

1. Gain and Return loss: Pin= -25dBm
2. Output IP3 (OIP3): Two tones, spaced 1 MHz apart, 5 dBm/tone at output.

### Recommended Application Circuit



*Fig 2. Test Board includes case, connectors, and components soldered to PCB*

### Product Marking

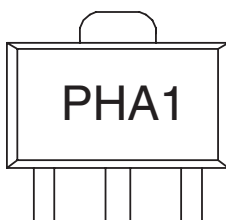

**Notes**

- A. Performance and quality attributes and conditions not expressly stated in this specification document are intended to be excluded and do not form a part of this specification document.
- B. Electrical specifications and performance data contained in this specification document are based on Mini-Circuit’s applicable established test performance criteria and measurement instructions.
- C. The parts covered by this specification document are subject to Mini-Circuits standard limited warranty and terms and conditions (collectively, “Standard Terms”); Purchasers of this part are entitled to the rights and benefits contained therein. For a full statement of the Standard Terms and the exclusive rights and remedies thereunder, please visit Mini-Circuits’ website at [www.minicircuits.com/MCLStore/terms.jsp](http://www.minicircuits.com/MCLStore/terms.jsp)

Additional Detailed Technical Information	
<i>additional information is available on our dash board. To access this information <a href="#">click here</a></i>	
<b>Performance Data</b>	Data Table
	Swept Graphs
	S-Parameter (S2P Files) Data Set (.zip file)
<b>Case Style</b>	DF782 (SOT 89) <i>Plastic package, exposed paddle lead finish: tin/silver/nickel</i>
<b>Tape &amp; Reel</b> Standard quantities available on reel	F55 <i>7" reels with 20, 50, 100, 200, 500 or 1K devices</i>
<b>Suggested Layout for PCB Design</b>	PL-313
<b>Evaluation Board</b>	TB-545-1+
<b>Environmental Ratings</b>	ENV08T1

### ESD Rating

Human Body Model (HBM): Class 1A (250 to <500V) in accordance with ANSI/ESD STM 5.1 - 2001

Machine Model (MM): Class M1 (>25V) in accordance with ANSI/ESD STM5.2-1999

### MSL Rating

Moisture Sensitivity: MSL1 in accordance with IPC/JEDEC J-STD-020D

### MSL Test Flow Chart

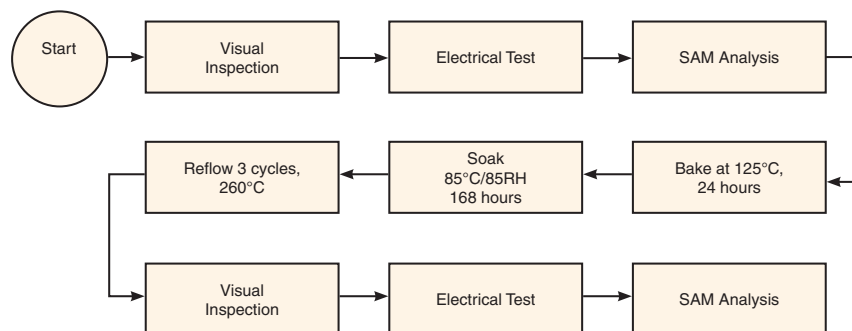

**Notes**

- A. Performance and quality attributes and conditions not expressly stated in this specification document are intended to be excluded and do not form a part of this specification document.
- B. Electrical specifications and performance data contained in this specification document are based on Mini-Circuit's applicable established test performance criteria and measurement instructions.
- C. The parts covered by this specification document are subject to Mini-Circuits standard limited warranty and terms and conditions (collectively, "Standard Terms"); Purchasers of this part are entitled to the rights and benefits contained therein. For a full statement of the Standard Terms and the exclusive rights and remedies thereunder, please visit Mini-Circuits' website at [www.minicircuits.com/MCLStore/terms.jsp](http://www.minicircuits.com/MCLStore/terms.jsp)