

PNP Germanium RF Transistor

AF 239 S

SIEMENS AKTIENGESELLSCHAFT

T-31-07

for output, mixer, and oscillator stages up to 900 MHz

AF 239 S is a germanium PNP mesa transistor in TO 72 case (18 A 4 DIN 41876). The leads are electrically insulated from the case.

Type	Ordering code
AF 239 S	Q62701-F51

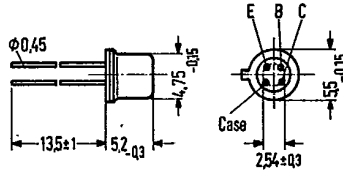

Approx. weight 0.4 g Dimensions in mm

Maximum ratings

Collector-emitter voltage	$-V_{CEO}$	15	V
Collector-emitter voltage	$-V_{CES}$	20	V
Emitter-base voltage	$-V_{EBO}$	0.3	V
Collector current	$-I_C$	10	mA
Emitter current	I_E	11	mA
Base current	$-I_B$	1	mA
Junction temperature	T_j	90	°C
Storage temperature range	T_{stg}	-30 to +75	°C
Total power dissipation ($T_{amb} \leq 45^\circ\text{C}$)	P_{tot}	60	mW

Thermal resistance

Junction to ambient air	R_{thJA}	≤ 750	K/W
Junction to case	R_{thJC}	≤ 400	K/W

Static characteristics ($T_{amb} = 25^{\circ}\text{C}$)

$-V_{CE}$ V	I_C mA	$-I_B$ μA	h_{FE} I_C/I_B	$-V_{BE}$ mV
10	2	40	50 (>10)	350
5	5	110	45	400

Collector cutoff current ($-V_{CES} = 20\text{ V}$)	$-I_{CES}$	0.5 (<8)	μA
Collector cutoff current ($-V_{CEO} = 15\text{ V}$)	$-I_{CEO}$	<500	μA
Emitter cutoff current ($-V_{EBO} = 0.3\text{ V}$)	$-I_{EBO}$	<100	μA

Dynamic characteristics ($T_{amb} = 25^{\circ}\text{C}$)

Transition frequency ($-I_C = 2\text{ mA}$; $-V_{CE} = 10\text{ V}$; $f = 100\text{ MHz}$)	f_T	780	MHz
Reverse transfer capacitance ($-I_C = 2\text{ mA}$; $-V_{CE} = 10\text{ V}$; $f = 450\text{ kHz}$)	$-C_{12e}$	0.2	pF

Power gain

Operating point: $-I_C = 2\text{ mA}$; $-V_{CE} = 10\text{ V}$

($f = 800\text{ MHz}$; $R_L = 500\ \Omega$)	G_{pb}	12.5	dB
($f = 800\text{ MHz}$; $R_L = 2\text{ k}\Omega$)	G_{pb}	15 (>12.5)	dB
($f = 900\text{ MHz}$; $R_L = 500\ \Omega$)	G_{pb}	12	dB
Noise figure ($f = 800\text{ MHz}$; $R_g = 60\ \Omega$)	NF	<5	dB
($f = 900\text{ MHz}$; $R_g = 60\ \Omega$)	NF	<6	dB

Test circuit for power gain and noise figure at $f = 800\text{ MHz}$

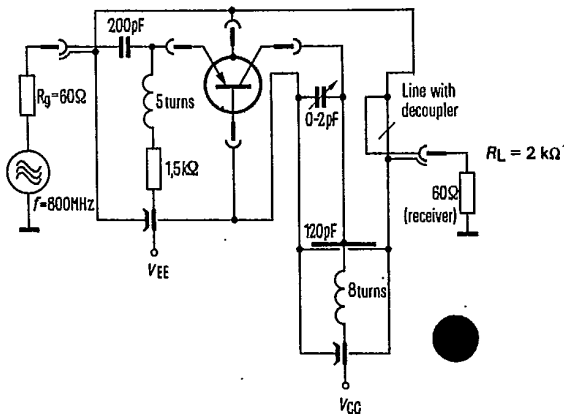

T-31-07

Total perm. power dissipation versus temperature $P_{tot} = f(T)$; R_{th} = parameter

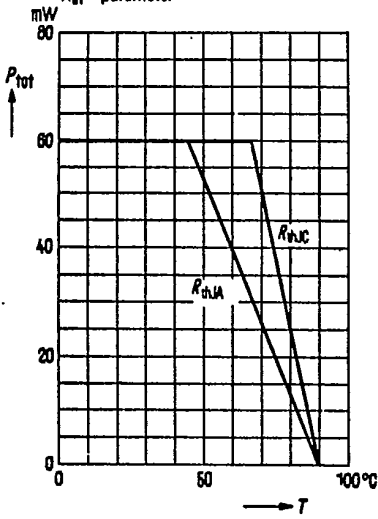

Collector cutoff current versus temperature $I_{CBO} = f(T_{amb})$; $-V_{CBO} = 20V$

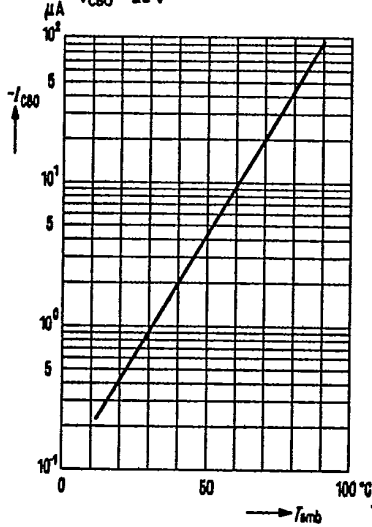

Collector current $I_C = f(I_B)$; V_{CE} = parameter (common emitter configuration)

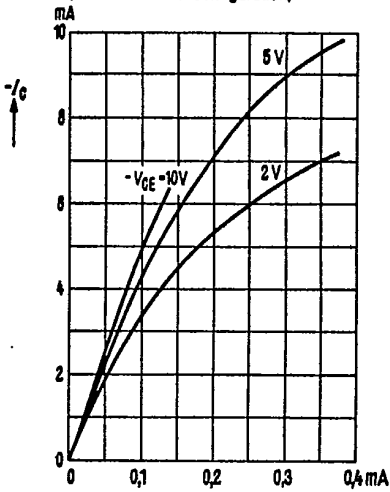

Collector current $I_C = f(V_{BE})$; V_{CE} = parameter (common emitter configuration)

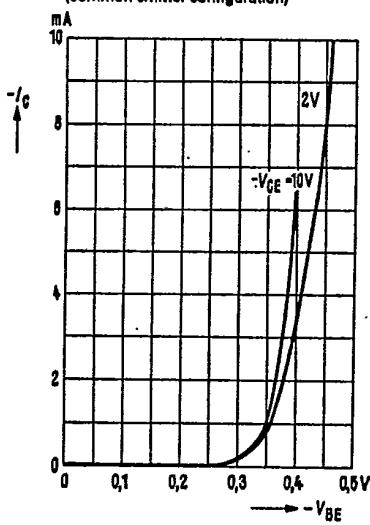

Output characteristics $I_C = f(V_{CE})$
 $I_B = \text{parameter}$
 (common emitter configuration)

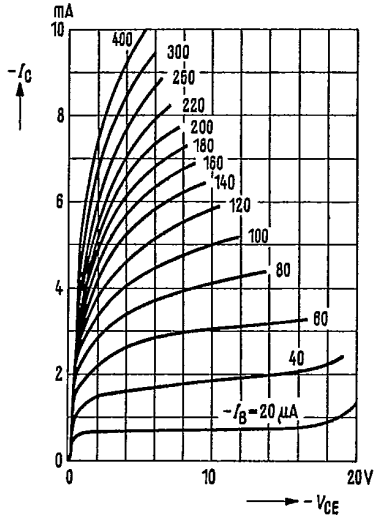

Output characteristics $I_C = f(V_{CB})$
 $I_E = \text{parameter}$
 (common base configuration)

