

February 2002

Specifications  
for  
GPS Receiver

**GH-79L4-N**

By FURUNO ELECTRIC CO., LTD.  
System Products Division

No part of this manual may be reproduced or transmitted in any form or by any means, electronic or mechanical, including photocopying and recording, for any purpose without the express written permission of the publisher, FURUNO ELECTRIC CO., LTD.  
© 2000 FURUNO ELECTRIC CO., LTD. All rights reserved.

The Global Positioning System (GPS) is operated by the U. S. DoD and is subject to U. S. Government Selective Availability (SA) policy, thus FURUNO is not liable for the degradation by SA. Users are expected to be familiar with the System and make full use of it with their own responsibility.

Table of Contents

<b>1. Outline .....</b>	<b>1</b>
1.1 Model Name .....	1
<b>2. Specifications .....</b>	<b>1</b>
2.1 General Specifications .....	1
2.2 Outer Dimensions .....	1
2.3 Electrical Specifications .....	2
2.4 Absolute Maximum Ratings .....	2
2.5 Ratings .....	3
2.6 Environmental Conditions .....	3
<b>3. Software Specifications .....</b>	<b>4</b>
3.1 Program Number .....	4
3.2 Communication Specifications .....	4
3.3 About NMEA-0183 Protocol .....	5
3.3.1 Approved Sentences .....	5
3.3.2 Proprietary Sentences .....	6
3.4 List of NMEA-0183 Sentences .....	7
3.5 List of Parameters & Backed-Up Data .....	8
3.6 NMEA-0183 Input Sentences .....	9
\$XXGLL (in) .....	9
\$XXGGA (in) .....	10
\$XXZDA (in) .....	11
\$XXRMC (in) .....	12
\$PFEC,GPcIr (in) .....	13
\$PFEC,GPset (in) .....	14
\$PFEC,GPsrq (in) .....	16
\$PFEC,GPint (in) .....	17
\$PFEC,GPirq (in) .....	18
\$PFEC,GPdif (in) .....	19
\$PFEC,GPdrq (in) .....	20
\$PFEC,GPslp (in) .....	20
3.7 NMEA-0183 OUTPUT SENTENCES .....	21
\$GPDtm (out) .....	21
\$GPGGA (out) .....	22
\$GPZDA (out) .....	23
\$GPGLL (out) .....	24
\$GPGSA (out) .....	25
\$GPGSV (out) .....	26
\$GPVTG (out) .....	27
\$GPRMC (out) .....	28
\$PFEC,GPanc (out) .....	29
\$PFEC,GPacc (out) .....	30
\$PFEC,GPast (out) .....	31
\$PFEC,GPtst (out) .....	32
\$PFEC,GPssd (Answer to \$PFEC,GPsrq) .....	33
\$PFEC,GPisd (Answer to \$PFEC,GPirq) .....	34
\$PFEC,GPdsd (Answer to \$PFEC,GPdrq) .....	35
\$PFEC,GPdie (out) .....	36
\$PFEC,GPslp (out) .....	37
\$PFEC,GPspe,ANCOUT (in) .....	37
\$PFEC,GPspe,ANCINP (in) .....	38
<b>4. Geodetic ID .....</b>	<b>39</b>
<b>5. Intermittent Operation Mode .....</b>	<b>44</b>
5.1 Overall of Intermittent Operation Mode .....	44
5.2 Recovery From Sleep to Position Calculation .....	45
5.3 Position Calculation after successful fix .....	46
5.4 Changing Operational Mode to Normal Mode .....	47
Specifications for Wake up signal .....	47
5.5 Obtaining the First Fix and Ephemeris Update .....	48
5.6 Intermittent Operation Status Output .....	49
5.7 Command Acceptance During Sleep .....	49
5.8 Automatic Ephemeris Update .....	50
<b>6. Autonomous start with ROM Almanac .....</b>	<b>52</b>

## 1. Outline

### 1.1 Model Name

GH-79L4-N

## 2. Specifications

### 2.1 General Specifications

Item	Specifications
Numbers of Channel/Method	12 ch/Parallel
Interface	Asynchronous, Serial
Protocol	NMEA-0183
Data Update Rate	1 second
Receiving Sensitivity (*)	> -130dBm

(\*) Minimum signal level to continue satellite tracking.

### 2.2 Outer Dimensions

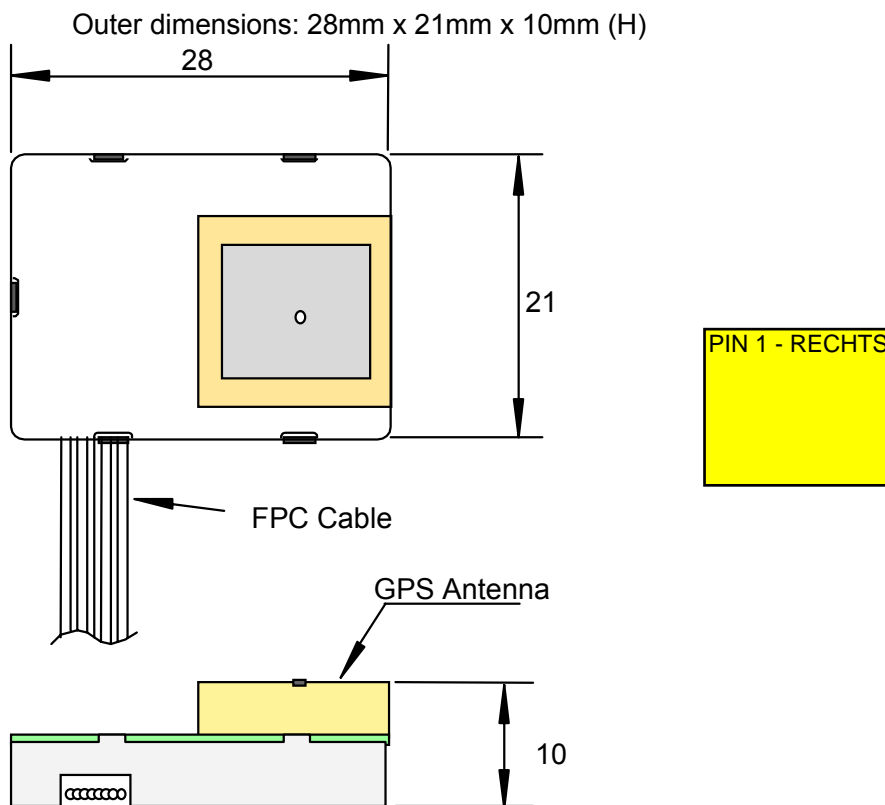

Drawing 1

## 2.3 Electrical Specifications

### Communication Connector & Pin Assignment

Connector Type : CFP4508-0101 (by SMK)

Matching Cable : 0.5mm pitch, FPC Cable

Pin #	Signal	Function
1	VCC	Power Supply
2	VBAT	Back-up Power Supply (*)
3	TD	Data Output
4	RD	Data Input
5	Wake up	Wake up signal input
6	N. C.	Reserved for future application
7	GND	Ground
8	N. C.	Do not connect

(\*) No internal backup power supply is available.

## 2.4 Absolute Maximum Ratings

Item	Maximum Ratings	Unit	Conditions
Vcc Input Voltage	-0.3 to +4.6	V	
VBAT Input Voltage	-0.3 to +4.6	V	
TD Output Current	±20	mA	The current into the GH-79 should be (+).
TD Output Voltage	-0.3 to +3.0	V	Vcc=0V
	-0.3 to Vcc+3.0		
RD Input Voltage	-0.3 to +3.0	V	Vcc=0V
	-0.3 to Vcc+3.0		

## 2.5 Ratings

Item			Min.	Typical	Max.	Unit	Remarks
TD (Output)	H	Voltage	2.4		VCC	V	10H=-2mA
	L	Voltage			0.4	V	10L=6mA
RD <sup>(*)</sup> (Input)	H	Voltage	2.0			V	
		Current			± 100	uA	@Vcc
	L	Voltage			0.8	V	
		Current			-1.2	mA	@0.8V
VBAT	Voltage		2.5		3.6	V	
	Consumption Current			5	10	uA	Vcc=0V, VBAT=3.0V. Ta=25°C
VCC	Voltage		3.1		3.6	V	
	Current			76	86	mA	VCC=3.6V

(\*) Pulled up to VCC through 4.7 kohm (±5 %) Register.

RD Input Equivalent Circuit

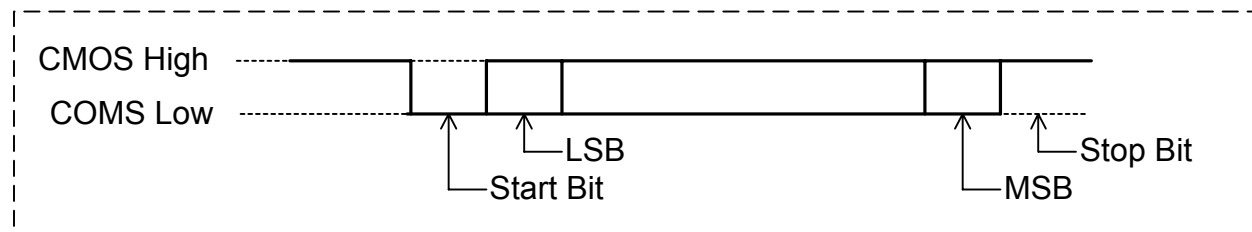
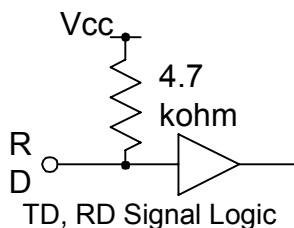

Drawing 2

## 2.6 Environmental Conditions

Item	Specifications	Unit	Remarks
Operating Temperature	-30 to +80	°C	
Storage Temperature	-40 to +85	°C	
Operating Humidity	90	%R. H.	@ +60°C No condensation

### 3. Software Specifications

#### 3.1 Program Number

Program number : 48502180\*\* (\*\* represents version number)

#### 3.2 Communication Specifications

System: Full Duplex Asynchronous  
Speed: 4800 BPS  
Start Bit: 1 bit  
Data Length: 8 bits (MSB=0)  
Stop Bit: 1 bit  
Parity Bit: None

Start Bit	B0	B1	B2	B3	B4	B5	B6	B7	Stop Bit
-----------	----	----	----	----	----	----	----	----	----------

Flow Control: None  
Signal Lines used: TD1 and RD1 only (TD2 and RD2 not used)  
Data Output Interval: 0 to 2 seconds

Character Codes used

NMEA-0183 Sentences: ASCII (HEX 0D,0A,20 to 7E)

Differential GPS Data: Binary ("6-of-8" format)  
(B7=0, B6=1, Only B5 to B0 are used.)

Electrical specification Similar to RS-232C

Protocol:

NMEA-0183 Sentences: NMEA-0183 Ver 2.30 dated March 1, 1998  
(Approved/proprietary sentences)  
(Input/Output)

Differential GPS Data RTCM SC-104 Ver 2.1 dated January 3, 1994  
(Input only)

NOTE: NMEA-0183 sentence and differential GPS data inputs may coexist because the GN79 can distinguish them automatically.

### 3.3 About NMEA-0183 Protocol

#### 3.3.1 Approved Sentences

Approved sentences are those of which formats are defined and fixed within the NMEA 0183 Standard. Any portion within an approved sentence format is NOT user-definable. An approved sentence generally takes the following form:

\$<address field>,<data field>.....[\*<checksum field>]<CR><LF>

Where:

Field	Description
\$	Start-of-Sentence marker
<address field>	5-byte fixed length. First 2 bytes represent a talker ID, and the rest 3 bytes do a sentence formatter.  All sentences transmitted by GH-79L bear talker ID "GP" meaning a GPS receiver.  For the sentences received from external equipment, the GH-79L accepts any talker ID. Talker ID "XX" found on the succeeding pages is a wildcard meaning "any valid talker ID".
,<data field>....	Variable or fixed-length fields preceded by delimiter ","(comma).  Comma(s) are required even when valid field data are not available i.e. null fields. Ex. ",,,,,"  In a numeric field with fixed field length, fill unused leading digits with zeroes.
*<checksum field>	8 bits data between "\$" and "*" (excluding "\$" and "*") are XORed, and the resultant value is converted to 2 bytes of hexadecimal letters. Note that two hexadecimal letters must be preceded by "*", and delimiter "," is not required before *<checksum>.  All output sentences have checksum.  For input sentences, the resultant value is checked and if it is not correct, the sentence is treated invalid.  No checksum is added to almanac data, which is either up-loaded to or down-loaded from the receiver. The responding sentences to almanac up-loading or down-loading have no check-sum, either.
<CR><LF>	End-of-Sentence marker

Maximum length from "\$" to <CR><LF> is limited to 82 bytes including "\$" and <CR><LF>. Every input sentence in and over 83 bytes is ignored. Be careful with entering GPset and Gpint sentences. Suggest to verify if the input is done correctly by issuing GPSrq, GPirq, GPdrq sentences. Please see 3.4 LIST OF NMEA-0183 SENTENCES (page 11).

#### Examples of Approved Sentences:

\$GPGLL,3444.000,N,13521.000,E <CR><LF>

\$XXGLL,3444.000,N,13521.000,E<CR><LF>

"XX" may be any valid talker ID, such as "LC"(Loran C).



### 3.3.2 Proprietary Sentences

The NMEA-0183 standard allows nav-aid makers to send proprietary sentences if the minimum rules defined by the NMEA are obeyed. Proprietary sentences must take the following form, but it is free to makers what kind of fields are included and in what order they are transmitted out.

\$P<maker ID>,<data field>....<\*check sum field><CR><LF>

Where:

Field	Description
\$	Start-of-Sentence marker
P	Proprietary sentence identifier
<maker ID>	3-byte fixed length. GH-79L's maker ID is "FEC" meaning Furuno Electric Company.
,<data field>....	Variable or fixed-length fields preceded by delimiter ","(comma). (Layout is maker-definable.)
<check sum field>	8 bits data between "\$" and "*" (excluding "\$" and "*") are XORed, and the resultant value is converted to 2 bytes of hexadecimal letters. Note that two hexadecimal letters must be preceded by "*", and delimiter "," is not required before *<checksum>.  All output sentences have checksum.  For input sentences, the resultant value is checked and if it is not correct, the sentence is treated invalid.  No checksum is added to almanac data, which is either up-loaded to or down-loaded from the receiver. The responding sentences to almanac up-loading or down-loading have no check-sum, either.
<CR><LF>	End-of-Sentence marker

### 3.4 List of NMEA-0183 Sentences

GH-79L supports following NMEA-0183 sentences.

		Input Sentences		Output Sentences		
↑ PRIORITY ↓	HIGH			GPDTM	Datum	
		XXGGA	Set initial position	GPGGA	Position, time etc.	OO
		XXZDA	Set time, etc.	GPZDA	Time etc.	OO
		XXGLL	Set initial position	GPGLL	Position, time, etc.	O
				GPGSA	Status, DOP	O
				GPGSV	Satellite details	OO
				GPVTG	Speed, Course.	OO
		XXRMC	Set initial position, time	GPRMC	Position, time, speed, course	O
				GPalt	No. of satellites expected in coming 24 hours	O
				GPanc	Date of existing almanac	O
				GPacc	SV accuracy	O
				GPast	GPS fix (position, local time)	O
				GPtst	Selftest result	O
		GPsrq	Send GPS receiver parameters	GPssd	Answer to GPsrq	A
		GPirq	Send data output interval	GPisd	Answer to GPirq	A
		GPdrq	Send DGPS parameters	GPdsd	Answer to GPdrq	A
				GPdie	DGPS status	O
		GPclr	Restart	GPslp	Monitor sleep parameters	A
		GPset	Set rx parameters			
		GPint	Set sentence output interval			
	GPdif	Set DGPS parameters				
LOW		GPslp	Set sleep function			

- NOTE 1: Higher priority data is output first, from top to bottom. (Highest priority:GGA for example).  
 GPDTM is always output in front of each of GGA, GLL, RMC, Gpast sentence.
- O Sentence output interval is adjustable but if the back up is lost, the sentence will not be output.
  - OO Sentence output interval is adjustable and if the back up is lost, it goes back to the default value, which is one second interval.
  - A Sentence is output as an answer.
  - XX Any talker ID

### 3.5 List of Parameters & Backed-Up Data

	Data	Back-up	Default	Range
GPS Data	Estimated position Lat. Long.	Yes	N34deg.44.0000 min. E135deg.21.0000 min.	S90deg. to N90deg. W180deg. to E180deg.
	Time	Yes	1997 Jan.1 0h.0m.12s	1997 Jan. 1 through 2040 Dec. 31
	Altitude	Yes	0 m	-999.9m to 17999.9m
	Almanac data	Yes	---	---
	Almanac date	Yes	1980 Jan. 6 0h.0m.0s	---
	Ephemeris	Yes	---	---
Parameters	Local Zone Time	Yes	+0h	-13h0m to +13h0m
	PDOP value	Yes	6	0 to 10
	Elevation Angle Mask	Yes	5 deg.	5 to 90 deg.
	Geodetic ID	Yes	1 (WGS84)	1 to 171
	Mask by Elevation Angle for Receivable Satellites Prediction	Yes	5 deg.	5 to 90 deg.
	Mask by Signal Strength	No	1dBHz (No mask)	1 to 99 dBHz
	1PPS Correction	Yes	0 µsec	-999.9 µsec to +999.9 µsec
	Delete Satellites	No	00000000	00000000 to FFFFFFFF
	Smoothing Index	No	2	1 to 3
	Dynamic Index	No	2	1 to 3
	Data Output Interval	Yes	DTM,GGA,ZDA,GSV,VTG (Every second)	0-60 seconds (Only for those sentences that are adjustable. See 3.4 List of NMEA sentences.)
	DGPS parameter	Yes	1 (LSB first)	1 (LSB first) 2 (MSB first)

### 3.6 NMEA-0183 Input Sentences

**\$XXGLL(in)**  
Set initial position

This sentence sets the initial latitude/longitude. The position data will be updated when position fixing begins.

Example

<b>\$XXGLL</b>	,3444.123,N	,13521,E	,,,	*4D	CR LF
<b>Field #</b>	1   2	3   4	5 6 7	8	

#.	Description	Range	[Bytes]
1-2.	Latitude		
	"34":degree	00-90	[2]
	"44": minute (integer)	00-59	[2]
	"123": minute (fraction)	0-9999	[variable] See NOTE.
	"N": North/South	N or S	[1]
3-4.	Longitude		
	"135": degree	000-180	[3]
	"21": Minute (integer)	00-59	[2]
	"": Minute (fraction)	0-9999	[variable] See NOTE
	"E": East/West	E or W	[1]
	NOTE: Digits below 1/10000 are ignored.		
5-7.	Null Fields	Any entry is ignored.	
8.	Checksum		[2]

Interpreting Example

**34 deg 44.1230 min N**  
**135 deg 21.0000 min E**

**\$XXGGA (in)**  
**Set initial position**

This sentence sets the initial latitude/longitude. The position data will be updated when position fixing begins.

Example

<b>\$XXGGA</b>	<b>,</b>	<b>,3444,N</b>	<b>,13521,E</b>	<b>,,,,,,,,,,</b>	<b>*79</b>	<b>CR LF</b>	
<b>Field #</b>	<b>1</b>	<b>2</b>	<b>3</b>	<b>4</b>	<b>5</b>	<b>6-14</b>	<b>15</b>

<b>#.</b>	<b>Description</b>	<b>Range</b>	<b>[Bytes]</b>
2-3.	Latitude		
	“34”:degree	00-90	[2]
	“44”: minute (integer)	00-59	[2]
	“”: minute (fraction)	0-9999	[variable] See NOTE.
	“N”: North/South	N or S	[1]
4-5.	Longitude		
	“135”: degree	000-180	[3]
	“21”: Minute (integer)	00-59	[2]
	“”: Minute (fraction)	0-9999	[variable] See NOTE.
	“E”: East/West	E or W	[1]
	NOTE: Digits below 1/10000 are ignored.		
6-14.	Null Fields	Any entry is ignored.	
15.	Checksum		[2]

Interpreting Example

**34 deg 44.0000 min N**  
**135 deg 21.0000 min E**

**\$XXZDA (in)**  
Set date/time

Example

<b>\$XXZDA</b>	<b>,123456</b>	<b>,01</b>	<b>,02</b>	<b>,1997</b>	<b>,-09</b>	<b>,00</b>	<b>*79</b>	<b>CR LF</b>
<b>Field #</b>	<b>1</b>	<b>2</b>	<b>3</b>	<b>4</b>	<b>5</b>	<b>6</b>	<b>7</b>	

#.	Description	Range	[Bytes]
1.	UTC: Time		
	"12": hh	00-23	[2]
	"34": mm	00-59	[2]
	"56": ss	00-59	[2]
2.	UTC: Date		
	"01": DD	01-31	[2]
3.	UTC: Month		
	"02": MM	01-12	[2]
4.	UTC: Year		
	"1997": YYYY	1997-2040	[4]
5.	Local Zone Time (Hour)		
	"-09": hh	-13 ... +00 ... +13	[3]
		(-/+ : East/west of date line)	
6.	Local Zone Time (Minute)		
	"00": mm	00 to 59	[2]
	NOTE: Local zone time setting is used for calculating local time when outputting GPS fix (\$PFEC,GPast): (Local Time)=(UTC)-(Local Zone Time)		
7.	Checksum		[2]

Interpreting Example

**February 1, 1997**  
**12:34:56**  
**Local Zone Time: -09:00**

**\$XXRMC (in)**  
Set initial position/UTC

Example

<b>\$XXRMC</b>	,123456	,	,3444.123,N	,13521.456,E	,,	,020197	,,,
<b>Field #</b>	1	2	3 4	5 6	7 8	9	10 11 12

<b>*69</b>	<b>CR LF</b>
13	

#.	Description	Range	[Bytes]
1.	UTC: Time		
	"12": hh	00-23	[2]
	"34": mm	00-59	[2]
	"56": ss	00-59	[2]
2.	Null Field	Any entry is ignored.	
3-4.	Latitude		
	"34":degree	00-90	[2]
	"44": minute (integer)	00-59	[2]
	"123": minute (fraction)	0-9999	[variable] See NOTE.
	"N": North/South	N or S	[1]
5-6.	Longitude		
	"135": degree	000-180	[3]
	"21": Minute (integer)	00-59	[2]
	"456": Minute (fraction)	0-9999	[variable] See NOTE.
	"E": East/West	E or W	[1]
	NOTE: Digits below 1/10000 are ignored.		
7-8.	Null Fields	Any entry is ignored.	
9.	UTC: Date		
	"02": DD	01-31	[2]
	"01": MM	01-12	[2]
	"97": YY	97-40	[2]
		(1997-2040)	
10-12.	Null Fields	Any entry is ignored.	
13.	Checksum		[2]

Interpreting Example

**January 2, 1997**  
**12:34:56**  
**34 deg. 44.1230 min. N**  
**135 deg. 21.4560 min. E**

**\$PFEC,GPclr (in)**  
Restart

Example

<b>\$PFEC</b>	<b>,GPclr</b>	<b>,1</b>	<b>*4B</b>	<b>CR LF</b>
<b>Field #</b>	<b>1</b>	<b>2</b>	<b>3</b>	

This sentence clears the data in the GPS receiver and restarts the receiver. The restart works in the same way as the power is first on.

#.	Description	Range	[Bytes]
1.	Command name		[5]
2.	Mode	1-3 "1": Clear mode 1 "2": Clear mode 2 "3": Clear mode 3	[1]
3.	Checksum		[2]

Receiver Data	Clear mode		
	1	2	3
Latitude/Longitude	Returned to default	Backed-up value used	Backed-up value used
Time	Backed-up value used	Backed-up value used	Backed-up value used
Almanac Data	Deleted	Backed-up value used, if valid.	Deleted
Ephemeris Data	Deleted	Backed-up value used, if avalid.	Deleted
Receiver Parameters (Note 1)	All parameters returned to default	Backed-up value used.	Backed-up value used

Note 1 : Receiver parameters are those set by "\$PFEC,GPset" sentence. Refer to the "3.5. List of Parameters & Backed-up data" to see whether the value set by the sentence is backed up or not.

Interpreting Example

**Clear mode 1**



**\$PFEC,GPset (in)**  
**Setup receiver parameters**

Example

<b>\$PFEC</b>	<b>,GPset</b>	<b>,D05</b>	<b>,U00200000</b>	.....	<b>*hh</b>	<b>CR LF</b>
<b>Field #</b>	<b>1</b>	<b>2</b>	<b>3</b>	<b>4.....</b>	<b>5</b>	

#.	Description	Range	[Bytes] (Unit) {Default}
1.	Command name		[5]
2.			
3.			
4.....			

Up to eight parameters in any order preceded by delimiter “,”(comma).  
See parameter syntax below:  
NOTE: Do not send same parameter twice within the same sentence.

**“Dnn”**: PDOP Threshold D00-D10 [3] (n/a) {D06}  
In 3D positioning mode, 2D positioning is forced when PDOP is higher than this threshold. If D00 is set, 3D positioning is not performed. In 2D positioning, the altitude is not updated and the same altitude is continuously output as set at the first 2D positioning.

**“Enn”**: Reserved

**“Gnn”**: Geodetic ID G001-G171 [4] (n/a) {G001}

**“Hnnnnnn.n”**: Altitude for 2D positioning H-00999.9 to H017999.9 [9] (meter) {H000000.0}  
NOTE: When 3D positioning is performed, this data is updated.

**“Mnn”**: Mask by Elevation Angle M05-M90 [3] (degree) {M05}  
Satellites below this angle are ignored when positioning.

**“Snn”**: Mask by Signal Strength S01-S99 [3] (dBHz) {S01}  
Satellites weaker than this level are ignored when positioning. The minimum level is practically limited by the lowest tracking signal level (38dBHz).

**“Tnnnnn”**: 1PPS Correction T-9999 to T+9999 [6] (x0.1 us) {T+0000}  
0.1us corresponds 30 meter antenna length. Note that negative setting advances 1PPS pulses.

**“Uhhhhhhh”**: Delete satellites.U00000000 - UFFFFFFF [9] (n/a) {n/a}  
hhhhhhh means eight hexadecimal letters, representing a bit map of 32 bits. Each bit within the bit map represents one satellite; 0000001 and 8000000, for example, indicate satellite SV#1 and SV#32, respectively.

Example: “PFEC,GPset,U0000000F”<CR><LF> declares unhealthy satellites SV#1 to SV#4.

Satellites declared by this sentence are ignored when positioning. It should be noted that satellites with their bits cleared are declared as “healthy”. In the above example, satellites SV#5 to SV#32 are implicitly declared as “healthy”.

In the following example, the first sentence declares satellite SV#5 as “unhealthy”, and it is restored later by the second sentence.

Example: “PFEC,GPset,U00000010”<CR><LF>  
“PFEC,GPset,U00000000”<CR><LF>

**“Wn”**: Smoothing Index W1-W3 [2] (n/a) {W2}

Specifications for GPS receiver GH-79L4

Index	Characteristics	Remarks
1	Quick responsive	Quicker response but relatively more zigzag tracking record.
2	Averaged	Averaged tuning (Initial setting)
3	Smoother tracking record	Less responsive (large inertia) but smoother tracking record

“Xn”: Dynamic Index

X1-X3

[2] (n/a) {X2}

Index	Characteristics	Remarks
1	More accurate positioning	Higher accuracy but less frequent positioning
2	Averaged	Averaged tuning (initial setting)
3	More frequent positioning	More frequent positioning but less accuracy.

5. Checksum

[2]

**\$PFEC,GPsrq (in)**  
**Get receiver parameters**

Issue this sentence when you need receiver parameters set by \$PFEC,GPset. The answer will be output as \$PFEC,GPssd sentence.

<b>\$PFEC,</b>	<b>,GPsrq</b>	<b>*5B</b>	<b>CR LF</b>
<b>Field #</b>	<b>1</b>	<b>2</b>	

<b>#.</b>	<b>Description</b>	<b>Range</b>	<b>[Bytes]</b>
1.	Command name		[5]
2.	Checksum		[2]

**\$PFEC,GPint (in)**  
Request output/Set log output intervals

Example

<b>\$PFEC</b>	<b>,GPint</b>	<b>,GGA01</b>	<b>,GLL00</b>	<b>.....</b>	<b>*hh</b>	<b>CR LF</b>
<b>Field #</b>	<b>1</b>	<b>2</b>	<b>3</b>	<b>4.....</b>	<b>n+1</b>	

#.	Description	Range	[Bytes](Unit){Default}
1.	Command name		[5]
2-n.	Sentence name & interval (00-60)		[5]
n+1.	Checksum		
	Up to 11 (eleven) parameters in any order preceded by delimiter “,”(comma). See parameter syntax below:		

“Param”:

Log Output Sentence

<Log Output Sentence Length in bytes>

“GGAnn”:\$GPGGA<82 max>	GGA00-GGA60	[5](sec){GGA01}
“ZDAnn”:\$GPZDA<36>	ZDA00-ZDA60	[5](sec){ZDA01}
“GLLnn”:\$GPGLL<47>	GLL00-GLL60	[5](sec){GLL00}
“GSAnn”:\$GPGSA<69 max>	GSA00-GSA60	[5](sec){GSA00}
“GSVnn”:\$GPGSV<70 max>	GSV00-GSV60	[5](sec){GSV01}
“VTGnn”:\$GPVTG<46 max>	VTG00-VTG60	[5](sec){VTG01}
“RMCnn”:\$GPRMC<77 max>	RMC00-RMC60	[5](sec){RMC00}
“ancnn”:\$PFEC,GPanc<62>	anc00-anc60	[5](sec){anc00}
“accnn”:\$PFEC,GPacc<49>	acc00-acc60	[5](sec){acc00}
“astnn”:\$PFEC,GPast<85>	ast00-ast60	[5](sec){ast00}
“tstnn”:\$PFEC,GPtst<33>	tst00-tst60	[5](sec){tst00}
“dienn”:\$PFEC,GPdie<27>	die00-die60	[5](sec){die00}

NOTE: If zero interval (nn=00) is specified, that sentence is output once when \$PFEC,GPint is executed, then output is disabled.

GH-79L can output 480 bytes per second. Do not set the log sentence output intervals too short, or this capacity will be exceeded. When estimating the output volume, refer to byte count of each sentence enclosed within [ ] in the above list.

Example

\$PFEC,GPint,tst00<CR><LF> ..... Output self-test result once.

\$PFEC,GPint,RMC05<CR><LF> ....Output \$GPRMC sentence every five seconds.

**\$PFEC,GPirq (in)**  
**Get log sentence output intervals**

Issue this sentence when you need the log sentence output intervals set by \$PFEC,GPint. The answer will be output as \$PFEC,GPisd sentence.

<b>\$PFEC,</b>	<b>,GPirq</b>	<b>*41</b>	<b>CR LF</b>
<b>Field #</b>	<b>1</b>	<b>2</b>	

<b>#.</b>	<b>Description</b>	<b>Range</b>	<b>[Bytes]</b>
1.	Command name		[5]
2.	Checksum		[2]

**\$PFEC,GPdif (in)**  
Set DGPS parameter

Example

<b>\$PFEC</b>	<b>,GPdif</b>	<b>,D0</b>	<b>*18</b>	<b>CR LF</b>
<b>Field #</b>	<b>1</b>	<b>2</b>	<b>3</b>	

#.	Description	Range	[Bytes]
1.	Command name		[5]
2.	Bit Stream Direction of RTCM SC-104 DGPS data.	D0-D1 “D0”: MSB first “D1”: LSB first	[2]
3.	Checksum		[2]

Interpreting Example

**DGPS data will be transmitted from MSB.**

**\$PFEC,GPdrq (in)**  
Get DGPS parameter

Issue this sentence when you need the DGPS parameter set by \$PFEC,GPdif. The answer will be output as \$PFEC,GPdsd sentence.

\$PFEC,	,GPdrp	*4C	CR LF
<b>Field #</b>	<b>1</b>	<b>2</b>	

#.	Description	Range	[Bytes]
1.	Command name		[5]
2.	Checksum		[2]

**\$PFEC,GPslp (in)**  
Get sleep function

\$PFEC,	,GPslp	,010	,060	,10	,1	*73	CR LF
<b>Field #</b>	<b>1</b>	<b>2</b>	<b>3</b>	<b>4</b>	<b>5</b>	<b>6</b>	

#.	Description	Range	[Bytes]
1.	Command name		[5]
2.	Sleep period (sec)	1 – 60	[3]
3.	Numbers of retry after sleep (sec)	3 – 127	[3]
4.	Positioning period after sleep (sec)	1 – 60	[2]
5.	Automatic ephemeris update	0: Deactivate 1: Activate	[1]
6.	Checksum		[2]

Note: "Period of positioning after sleep" is a length of time after successful positioning after returning from sleep to next sleep.

Note: It is recommended to set "Automatic ephemeris update" to "Activate" as using obsolete ephemeris results in longer positioning time after returning from sleep. Especially when retry time is less than 30 second or positioning period is less than 10 seconds, it is highly recommended.

While the function is activated, ephemeris older than 2 hours will be automatically updated.

### 3.7 NMEA-0183 OUTPUT SENTENCES

#### \$GPDTM (out) Datum

Example

\$GPDTM	,TOY	,M	,00.1697	,S	,00.1234	,E	.,W84	*05	CR LF
Field #	1	2	3	4	5	6	7 8	9	

#.	Description	Range	[Bytes]
1.	Local datum code		[3]
2.	Local datum sub code		[1]
3.	Latitude offset (minute)		[7]
4.	Latitude offset mark (N: +, S: -)		[1]
5.	Longitude offset (minute)		[7]
6.	Longitude offset mark (E: +, W: -)		[1]
7.	Altitude offset (m)	Always null	
8.	Datum	Always "W84"	[3]
9.	Checksum		[2]

Interpreting Example

**Datum 172 (Refer to section 5 "Geodetic ID" later on this manual)**



**\$GPGGA (out)**  
Position, altitude, UTC, etc.

Example

<b>\$GPGGA</b>	,123456	,3444.0000,N	,13521.0000,E			
Field #	1	2	3	4	5	
	,1	,04	,02.00	,000123.0	,M	,0036.0
	6	7	8	9	10	11
	,M	,13	,0001	*76	CR LF	
	12	13	14	15		

#.	Description	Range	[Bytes]
1.	UTC		
	“12”: hh	00-23	[2]
	“34”: mm	00-59	[2]
	“56”: ss	00-59	[2]
2-3.	Latitude		
	“34”: degree	0-90	[2]
	“44”: minute (integer)	0-59	[2]
	“0000”: minute (fraction)	0000-9999	[4]
	“N”: North/South	N or S	[1]
4-5.	Longitude		
	“135”: degree	000-180	[3]
	“21”: Minute (integer)	00-59	[2]
	“0000”: Minute (fraction)	0000-9999	[4]
	“E”: East/West	E or W	[1]
6.	GPS Quality Indication	0-2	[1]
	“0”: Fix not available or invalid.		
	“1”: GPS. SPS fix valid		
	“2”: GPS. SPS fix valid		
7.	No. of satellites used for positioning	00-12	[2]
8.	DOP (2D: HDOP 3D: PDOP)	n/a	[5]
	NOTE: “00.00” is output while positioning is interrupted.		
9.	Altitude	-00999.9 to 017999.9	[8]
10.	Unit for Altitude	M	[1]
11.	Geoide Altitude	-999.9 to 9999.9	[6]
12.	Unit for Geoide Altitude	M	[1]
13.	DGPS Data Time	00-99	[2]
	This value indicates the time elapsed since the last RTCM-SC104 TYPE 1 or 9 data is updated.		
	Unless DGPS mode is selected, a null field is output.		
14.	DGPS Station ID	0000-1023	[4]
	Unless DGPS mode is selected, a null field is output.		
15.	Checksum		[2]

Interpreting Example

**UTC 12:34:56**  
**34 deg 44.0000 min N**  
**135 deg 21.0000 min E**  
**Status: Stand-alone GPS**  
**No. of satellites: 4 satellites**  
**DOP: 2.00**  
**Altitude: 123.0 meters high**  
**Geoide Altitude: 36.0 meters high**  
**DGPS Data Time: 13**  
**DGPS Station ID: 1**

**\$GPZDA (out)**  
Date/Time

Example

<b>\$GPZDA</b>	<b>,123456</b>	<b>,01</b>	<b>,01</b>	<b>,1997</b>	<b>,+09</b>	<b>,00</b>	<b>*6B</b>	<b>CR LF</b>
<b>Field #</b>	<b>1</b>	<b>2</b>	<b>3</b>	<b>4</b>	<b>5</b>	<b>6</b>	<b>7</b>	

#.	Description	Range	[Bytes]
1.	UTC: Time		
	“12”: hh	00-23	[2]
	“34”: mm	00-59	[2]
	“56”: ss	00-59	[2]
2.	UTC: Day of Month		
	“01”: DD	01-31	[2]
3.	UTC: Month		
	“01”: MM	01-12	[2]
4.	UTC: Year		
	“1997”: YYYY	1997-2040	[4]
5.	Local Zone Time (Hour)		
	“+09”: hh	-13 ... +00 ... +13	[3]
		(-/+ : East/west of date line)	
6.	Local Zone Time (Minute)		
	“00”: mm	00 to 59	[2]
	NOTE: Local zone time setting is used for calculating local time when outputting \$PFEC,GPast: (Local Time)=(UTC) - (Local Zone Time)		
7.	Checksum		[2]

Interpreting Example

**January 1, 1997**

**12:34:56**

**Local Zone Time: +09:00**

**\$GPGLL (out)**  
Position, UTC, etc.

Example

<b>\$GPGLL</b>	<b>,3444.1234,N</b>	<b>,13521.0000,E</b>	<b>,123456</b>	<b>,A</b>	<b>,A</b>	<b>*43</b>	<b>CR LF</b>
<b>Field #</b>	<b>1</b>	<b>2</b>	<b>3</b>	<b>4</b>	<b>5</b>	<b>6</b>	<b>7</b>

#.	Description	Range	[Bytes]
1-2.	Latitude		
	“34”:degree	00-90	[2]
	“44”: minute (integer)	00-59	[2]
	“1234”: minute (fraction)	0000-9999	[4]
	“N”: North/South	N or S	[1]
3-4.	Longitude		
	“135”: degree	000-180	[3]
	“21”: Minute (integer)	00-59	[2]
	“0000”: Minute (fraction)	0000-9999	[4]
	“E”: East/West	E or W	[1]
5.	UTC		
	“12”: hh	00-23	[2]
	“34”: mm	00-59	[2]
	“56”: ss	00-59	[2]
6.	Status	A or V	[1]
		“A”: Data Valid (Stand-alone or DGPS)	
		“V”: Navigation receiver warning	
7.	Position System Mode Indication	A: Autonomous mode [1] D: Differential mode N: Data not valid	
8.	Checksum		[2]

Interpreting Example

**34 deg 44.1234 min N**  
**135 deg 21.0000 min E**  
**UTC: 12:34:56**  
**Status: Positioning**

**\$GPGSA (out)**  
Positioning status

Example

<b>\$GPGSA</b>	<b>,A</b>	<b>,3</b>	<b>,01</b>	<b>,02</b>	<b>,03</b>	<b>.....</b>	<b>,02.00</b>	<b>,03.00</b>	<b>,04.00</b>	<b>*hh</b>	<b>CR LF</b>
<b>Field #</b>	<b>1</b>	<b>2</b>	<b>3</b>	<b>4</b>	<b>5</b>	<b>6....14</b>	<b>15</b>	<b>16</b>	<b>17</b>	<b>18</b>	

<b>#.</b>	<b>Description</b>	<b>Range</b>	<b>[Bytes]</b>
1.	Operational Mode	M or A	[1]
		“M”: 2D-only Mode	
		“A”: 2D/3D Auto-switching Mode	
2.	Mode	1-3	[1]
		“1”: Fix not available	
		2”: 2D-positioning	
		3”: 3D-positioning	
3-14.	Satellite Numbers used for positioning	01-32	[2] or [0]
	NOTE: A null field is output unless a satellite is available.		
15.	PDOP	n/a	[5]
	NOTE: “00.00” is output unless 3D-positioning is performed.		
16.	HDOP	n/a	[5]
	NOTE: “00.00” is output while positioning is interrupted.		
17.	VDOP	n/a	[5]
	NOTE: “00.00” is output unless 3D-positioning is performed.		
18.	Checksum		[2]

Interpreting Example

**2D/3D Auto-switching Mode**

**3D-Positioning**

**Satellites used: 01,02,03....**

**PDOP: 2.00**

**HDOP: 3.00**

**VDOP: 4.00**

**\$GPGSV (out)**  
**Satellite details**

Example

<b>\$GPGSV</b>	<b>,2</b>	<b>,1</b>	<b>,06</b>	<b>,01</b>	<b>,05</b>	<b>,234</b>	<b>,56</b>	<b>,04</b>	<b>,11</b>	<b>,223</b>	<b>,44</b>
<b>Field #</b>	<b>1</b>	<b>2</b>	<b>3</b>	<b>4</b>	<b>5</b>	<b>6</b>	<b>7</b>	<b>8</b>	<b>9</b>	<b>10</b>	<b>11</b>

<b>,01</b>	<b>,75</b>	<b>,088</b>	<b>,32</b>	<b>,01</b>	<b>,42</b>	<b>,234</b>	<b>,48</b>	<b>*75</b>	<b>CR LF</b>
<b>12</b>	<b>13</b>	<b>14</b>	<b>15</b>	<b>16</b>	<b>17</b>	<b>18</b>	<b>19</b>	<b>20</b>	

#.	Description	Range	[Bytes](unit)
1.	Total No. of Messages	1-3	[1](n/a)
2.	No. of Message	1-3	[1](n/a)
3.	No. of satellites in line-of-site (with elevation angle higher than 5 degrees only)	00-12	[2](n/a)
4.	1st Sat. SV#	01-32	[2]
5.	1st Sat. Elevation Angle	05-90	[2](degree)
6.	1st Sat. Bearing Angle	000-359	[3](degree)
7.	1st Sat. SNR(Signal/Noise Ratio)(C/No)	00-99	[2](dBHz)
8-11.	2nd Sat. Details		[9]
12-15.	3rd Sat. Details		[9]
16-19.	4th Sat. Details		[9]
20.	Checksum		[2]

In this sentence, a maximum of four satellite details is indicated per each output. Five or more satellite details are output in the 2<sup>nd</sup> or 3<sup>rd</sup> messages. When there is only one to three satellite details, the checksum <CR> <LF> is issued immediately after Sat. SV#, Sat. Elevation Angle, Sat. Bearing Angle and SNR.

**\$GPVTG (out)**  
Course and speed

Example

<b>\$GPVTG</b>	<b>,012.3,T</b>	<b>,001.1,M</b>	<b>,001.2,N</b>	<b>,0002.2,K</b>	<b>,A</b>	<b>*10</b>	<b>CR LF</b>
<b>Field #</b>	<b>1 2</b>	<b>3 4</b>	<b>5 6</b>	<b>7 8</b>	<b>9</b>	<b>10</b>	

#.	Description	Range	[Bytes](unit)
1-2.	True Course "012.3" "T"(meaning TRUE) NOTE: A null field is output unless true course information is available.	000.0-359.9 T	[5](degree) [1](n/a)
3-4.	Magnetic Course "001.1" "M"(meaning MAGNETIC) NOTE: A null field is output unless magnetic course information is available.	000.0-359.9 M	[5](degree) [1](n/a)
5-6.	Speed (kts) "001.2" "N"(meaning knot) NOTE: A null field is output unless speed information is available.	000.0-999.9 N	[5](kts) [1](n/a)
7-8.	Speed (km/h) "0002.2" "K"(meaning Km/h) NOTE: A null field is output unless speed information is available.	0000.0-9999.9 K	[6](km/h) [1](n/a)
9.	Position System Mode Indicator	A: Autonomous mode D: Differential mode N: Data not valid	[1]
10.	Checksum		[2]

**\$GPRMC (out)**  
UTC, position, course, speed, etc.

Example

<b>\$GPRMC</b>	<b>,123456</b>	<b>,A</b>	<b>,3444.0000,N</b>	<b>,13521.0000,E</b>	<b>,005.6</b>	<b>,123.5</b>
<b>Field #</b>	<b>1</b>	<b>2</b>	<b>3</b>	<b>4</b>	<b>5</b>	<b>6</b>
<b>,020197</b>	<b>,001.0,W</b>	<b>,A</b>	<b>*07</b>	<b>CR LF</b>		
<b>9</b>	<b>10 11</b>	<b>12</b>	<b>13</b>			

#.	Description	Range	[Bytes]
1.	UTC: Time "12": hh "34": mm "56": ss	00-23 00-59 00-59	[2] [2] [2]
2.	Status "A": Data valid (Stand-alone or DGPS) "V": Navigation receiver warning	A or V	[1]
3-4.	Latitude "34":degree "44": minute (integer) "0000": minute (fraction) "N": North/South	00-90 00-59 0000-9999 N or S	[2] [2] [4] [1]
5-6.	Longitude "135": degree "21": Minute (integer) "0000": Minute (fraction) "E": East/West	000-180 00-59 0000-9999 E or W	[3] [2] [4] [1]
7.	Speed (kts) "005.6" NOTE: A null field is output unless speed information is available.	000.0-999.9	[5]
8.	True Course (degree) "123.5" NOTE: A null field is output unless true course information is available.	000.0-359.9	[5]
9.	UTC: Date "02": DD "01": MM "97": YY	01-31 01-12 97-40 (1997-2040)	[2] [2] [2]
10-11.	Magnetic Deviation (degree) "001.0" "W"	000.0-180.0 W or E	[5] [1]
12.	Positioning System Mode Indication A: Autonomous mode D: Differential mode N: Data not valid		[1]
13.	Checksum 8 bits data between "\$" and "*" (excluding "\$" and "*") are XORed, and the result is converted to 2 bytes of hexadecimal letters.		[2]

Interpreting Example

**UTC Time 12:34:56**  
**Positioning 34 deg. 44.1234 min. N, 135 deg. 21.4567 min. E**  
**Speed: 5.6 kts**  
**True Course: 123.5 degrees**  
**UTC Date Jan 2, 1995**  
**Magnetic Deviation: 1.0 degree, West**

**\$PFEC,GPanc (out)**  
**Almanac date and satellite's health condition**

Example

	Column 1		32		
<b>\$PFEC</b>	<b>,GPanc</b>	<b>,970102030405</b>	<b>,2222220022222222222200000222221</b>	<b>*4B</b>	<b>CR LF</b>
<b>Field #</b>	<b>1</b>	<b>2</b>	<b>3</b>	<b>4</b>	

- | #. | Description   | Range   | [Bytes] |
|----|---|---|---------|
| 1. | Command name  |   | [5]     |
| 2. | Almanac Date/Time (Local Date/Time)<br>"970102030405": YYMMDDhhmmss |   | [12]    |
| 3. | Heath conditions for 32 satellites                                  | 0-2   | [32]    |
|    |   | "0": Almanac not collected yet,<br>or that satellite is not launched yet. |         |
|    |   | "1": Unhealthy (Not used for positioning).                                |         |
|    |   | "2": Healthy (Usable for positioning)                                     |         |
|    | Each column represents each satellite.                              |   |         |
| 4. | Checksum  |   | [2]     |

Interpreting Example

**Almanac is obtained on Jan. 2, 1997 at 03h:04m:05s**

- SV#1 healthy**
- SV#2 healthy**
- SV#3 healthy**
- SV#4 healthy**
- SV#5 healthy**
- SV#6 healthy**
- SV#7 unhealthy**
- SV#8 unhealthy**
- SV#9 healthy**

.....



**\$PFEC,GPacc (out)**  
**SV(satellite) Accuracy**

Example

Column 1		32	
<b>\$PFEC</b>	<b>,GPacc</b>	<b>,222222XXXXXXXXXX77777XXXXXXXXXXBF</b>	<b>*0D CR LF</b>
<b>Field #</b>	<b>1</b>	<b>2</b>	<b>3</b>

#.	Description	Range	[Bytes]
1.	Command name		[5]
2.	SV accuracies for 32 satellites		[32]
		0-F: SV Accuracy in hexadecimal notation	
		X: SV Accuracy not available	
	Each column represents each satellite.		
3.	Checksum		[2]

Interpreting Example

SV#1 2  
 SV#2 2  
 SV#3 2  
 SV#4 2  
 SV#5 2  
 SV#6 2  
 SV#7 data not available  
 SV#8 data not available  
 SV#9 data not available  
 .....

**\$PFEC,GPast (out)**

Position, altitude, speed, course, local time, etc.

Example

<b>\$PFEC</b>	<b>,GPast</b>	<b>,4</b>	<b>,6</b>	<b>,1</b>	<b>,0356</b>	<b>,N34431234</b>	<b>,E135211234</b>	<b>,0012347</b>
<b>Field #</b>	<b>1</b>	<b>2</b>	<b>3</b>	<b>4</b>	<b>5</b>	<b>6</b>	<b>7</b>	<b>8</b>
	<b>,970123123456</b>	<b>,01235</b>	<b>,1234</b>	<b>,1345</b>	<b>*65</b>	<b>CR LF</b>		
	<b>9</b>	<b>10</b>	<b>11</b>	<b>12</b>	<b>13</b>			

#.	Description	Range	[Bytes]
1.	Command name		[5]
2.	Status	0, 3-6	[1]
		"0": Positioning not performed yet	
		"3": Stand-alone GPS, 2D	
		"4": Stand-alone GPS, 3D	
		"5": DGPS 2D	
		"6": DGPS 3D	
3.	No. of satellites used for positioning (0-9, A-C)		
	"6"	0-9, A: 10, B: 11, C: 12	[1]
4.	Seed/course calculation status		
	"1"	0-1	[1]
		"0": Data invalid (Can't calculate)	
		"1": Data valid	
5.	DOP x100 (2D: HDOP 3D: PDOP)		
	"0356"	0000-9999	[4]
NOTE: For actual DOP, divide the above value by 100.			
"0000" is output while positioning is interrupted.			
6.	Latitude		
	"N": North/South	N or S	[1]
	"34": degree	00-90	[2]
	"43": minute (integer)	00-59	[2]
	"1234": minute (fraction)	0000-9999	[4]
7.	Longitude		
	"E": East/West	E or W	[1]
	"135": degree	000-179	[3]
	"21": Minute (integer)	00-59	[2]
	"1234": Minute (fraction)	0000-9999	[4]
8.	Altitude (x10m)		
	"0012347"	-009999 to 0179999	[7]
NOTE: For actual altitude, divide the above value by 10.			
9.	Local Date/Time		
	"940123123456": YYMMDDhhmmss	n/a	[12]
NOTE: (Local date/time)=(UTC)-(Local Zone Time)			
Unless local zone time information is available, UTC is output.			
10.	Speed (x10 km/h)		
	"01235"	00000-18519	[5]
NOTE: For actual speed, divide the above value by 10.			
If speed/course calculation status (field#4) is "0"(invalid), previous output value is held.			
11.	True Course (x10 degrees)		
	"1234"	0000-3599	[4]
NOTE: For actual course, divide the above value by 10.			
If speed/course calculation status (field#4) is "0"(invalid), output value is held.			
12.	Magnetic Course (x10 degrees)		
	"1345"	0000-3599	[4]
NOTE: For actual course, divide the above value by 10.			
If speed/course calculation status (field#4) is "0"(invalid), output value is held.			
13.	Checksum		[2]

**\$PFEC,GPtst (out)**  
Self-test results

Example

<b>\$PFEC</b>	<b>,GPtst</b>	<b>,0</b>	<b>,4850218001</b>	<b>,08</b>	<b>*19</b>	<b>CR LF</b>
<b>Field #</b>	<b>1</b>	<b>2</b>	<b>3</b>	<b>4 5</b>	<b>6</b>	

#.	Description	Range	[Bytes](unit)
1.	Command name[5]		
2.	Status	0-1 "0": Testing now "1": Completed	[1]
3.	Program and Version Numbers		
	"48502180": Program No.	n/a	[8]
	"01": Version No.	n/a	[2]
4-5.	Self-test Results		
	"0": Result of Test I	0-1 "0": Normal "1": GPS data backup error (Including RTC back-up error)	[1]
	"8": Result of Test II	0-F	[1]

Code	Rx Param Backup	Antenna Error	RAM	ROM
"1"	ok	ok	ok	error
"2"	ok	ok	error	ok
"3"	ok	ok	error	error
"4"	ok	error	ok	ok
"5"	ok	error	ok	error
"6"	ok	error	error	ok
"7"	ok	error	error	error
"8"	error	ok	ok	ok
"9"	error	ok	ok	error
"A"	error	ok	error	ok
"B"	error	ok	error	error
"C"	error	error	ok	ok
"D"	error	error	ok	error
"E"	error	error	error	ok
"F"	error	error	error	error

6.	Checksum	[2]
----	----------	-----

**\$PFEC,GPssd (Answer to \$PFEC,GPsrq)**  
Receiver parameters set by \$PFEC,GPset

Example

<b>\$PFEC</b>	<b>,GPssd</b>	<b>,G001</b>	<b>.....</b>	<b>*hh</b>	<b>CR LF</b>
<b>Field #</b>	<b>1</b>	<b>2</b>	<b>3.....</b>	<b>n+1</b>	

<b>\$PFEC</b>	<b>,GPssd</b>	<b>,D08</b>	<b>.....</b>	<b>*hh</b>	<b>CR LF</b>
<b>Field #</b>	<b>1</b>	<b>2</b>	<b>3.....</b>	<b>n+1</b>	

<b>#.</b>	<b>Description</b>	<b>Range</b>	<b>[Bytes]</b>
1.	Command name		[5]
2-n.	Receiver parameters set by \$PFEC,GPset are output in two sentences. Each parameter is preceded by delimiter “,” (comma).		
n+1.	Checksum		[2]

**\$PFEC,GPisd (Answer to \$PFEC,GPirq)**  
 Log output intervals set by \$PFEC,GPint

Example

<b>\$PFEC</b>	<b>,GPisd</b>	<b>,GGA01</b>	<b>.....</b>	<b>*hh</b>	<b>CR LF</b>
Field #	1	2	3.....	n+1	

<b>\$PFEC</b>	<b>,GPisd</b>	<b>,tst00</b>	<b>.....</b>	<b>*hh</b>	<b>CR LF</b>
Field #	1	2	3.....	n+1	

#.	Description	Range	[Bytes]
1.	Command name		[5]
2-n.	Log output intervals set by \$PFEC,GPint are output in two sentences. Each parameter is preceded by delimiter “,” (comma).		
n+1.	Checksum		[2]

**\$PFEC,GPdsd (Answer to \$PFEC,GPdrq)**  
 DGPS parameters set by \$PFEC,GPdif

DGPS parameters set by \$PFEC,GPdif are output.

Example

<b>\$PFEC</b>	<b>,GPdsd</b>	<b>,D0</b>	<b>*02</b>	<b>CR LF</b>
<b>Field #</b>	<b>1</b>	<b>2</b>	<b>3</b>	

<b>#.</b>	<b>Description</b>	<b>Range</b>	<b>[Bytes]</b>
1.	Command name		[5]
2.	DGPS parameters set by \$PFEC,GPdif are output.		
3.	Checksum		[2]

**\$PFEC,GPdie (out)**  
Receiver status

Example

<b>\$PFEC</b>	<b>,GPdie</b>	<b>,1</b>	<b>,08</b>	<b>,0</b>	<b>,0</b>	<b>,0</b>	<b>*66</b>	<b>CR LF</b>
<b>Field#</b>	<b>1</b>	<b>2</b>	<b>3</b>	<b>4</b>	<b>5</b>	<b>6</b>	<b>7</b>	

#.	Description	Range	[Bytes]												
1.	Command name		[5]												
2.	DGPS status	0-1 "0": DGPS data not received yet "1": Receiving DGPS data  NOTE: This flag will be set a few seconds after DGPS data entry.	[1]												
3.	No. of DGPS Satellites "08"	n/a	[2]												
4.	DGPS Base station's Health Condition "0"	0-1 "0": healthy "1": unhealthy  NOTE: If DGPS station is unhealthy, stand-alone GPS function rather than DGPS is performed.	[1]												
5.	DGPS Data Status "0"	0-1 "0": Normal "1": Abnormal  NOTE: If DGPS data is invalid, stand-alone GPS function rather than DGPS is performed.	[1]												
6.	DGPS Error Code "0"	0-F	[1]												
<table border="1"> <thead> <tr> <th>Error code</th> <th>Meaning</th> </tr> </thead> <tbody> <tr> <td>0</td> <td>No error</td> </tr> <tr> <td>1</td> <td>In Type 1, Type 3 or Type 9 messages, the base station's health field indicates "unhealthy".</td> </tr> <tr> <td>2</td> <td>In Type 1 message, UDRE field indicates "3" meaning not usable due to big error.</td> </tr> <tr> <td>3</td> <td>3 or less satellites are available for differential data input</td> </tr> <tr> <td>4 to F</td> <td>Reserved</td> </tr> </tbody> </table>		Error code	Meaning	0	No error	1	In Type 1, Type 3 or Type 9 messages, the base station's health field indicates "unhealthy".	2	In Type 1 message, UDRE field indicates "3" meaning not usable due to big error.	3	3 or less satellites are available for differential data input	4 to F	Reserved		
Error code	Meaning														
0	No error														
1	In Type 1, Type 3 or Type 9 messages, the base station's health field indicates "unhealthy".														
2	In Type 1 message, UDRE field indicates "3" meaning not usable due to big error.														
3	3 or less satellites are available for differential data input														
4 to F	Reserved														
7.	Checksum		[2]												

Common Errors

If DGPS status (field #2) can not set to "1" (Receiving DGPS data), or if DGPS fix is not obtainable, suspect:

- \* Invalid format of incoming DGPS data
- \* Insufficient number of satellites in DGPS data
- \* DGPS station is faulty
- \* DGPS data is too old to correct positioning

**\$PFEC,GPslp (out)**  
Monitor sleep parameters

\$PFEC,	,GPslp	,010	,060	,10	,1	*73	CR LF
<b>Field #</b>	<b>1</b>	<b>2</b>	<b>3</b>	<b>4</b>	<b>5</b>	<b>6</b>	

#.	Description	Range	[Bytes]
1.	Command name		[5]
2.	Sleep period (sec)	1 – 60	[3]
3.	Numbers of retry after sleep (sec)	3 – 127	[3]
4.	Positioning period after sleep (sec)	1 – 60	[2]
5.	Automatic ephemeris update	0: Deactivate 1: Activate	[1]
6.	Checksum		[2]

**\$PFEC,GPspe,ANCOUT (in)**  
Down-load almanac

Issue this sentence when you need the almanac data from GH-79L.

\$PFEC,GPspe,ANCOUT	*63	CR LF
---------------------	-----	-------

As an answer to the above sentence, GH-79L outputs internal almanac data (about 6.0 kbytes of ASCII characters) in the following format.

Note that, after this sentence is received, the GH-79L stops positioning, receiving data, and outputting the other data than almanac data. After outputting the almanac data, the GH-79L will restart automatically (Restart clear mode 2).

**Example:**

#GP,TYP=GP77,	90A927FDE.....980FE3	#GP,END	CR LF
---------------	----------------------	---------	-------

It may be useful to save the downloaded almanac for future uploading.



**\$PFEC,GPspe,ANCINP (in)**  
Up-load almanac

Issue this sentence when you want to send almanac data to GH-79L. This function enables quicker Time-To-First-Fix.

<b>\$PFEC,GPspe,ANCINP</b>	<b>*7A</b>	<b>CR LF</b>
----------------------------	------------	--------------

Following the above sentence, send almanac data which you saved by \$PFEC,GPspe,ANCOUT before:

<b>#GP,TYP=GP79</b>	<b>90A927FDE.....980FE3</b>	<b>#GP,END</b>	<b>CR LF</b>
---------------------	-----------------------------	----------------	--------------

If uploading is completed successfully, GH-79L outputs the following acknowledgment and restarts by itself (Restart clear mode 2).

<b>\$ANC, OK</b>	<b>CR LF</b>
------------------	--------------

If uploading is failed, GH-79L requests you to send the entire almanac sentence again by outputting the following error message:

<b>\$ANC,NG</b>	<b>CR LF</b>
-----------------	--------------

“NG” means No Good.

## 4. Geodetic ID

There are many geodetic systems in the world. Enter a right geodetic system ID in accordance with your chart or map in use. If the geodetic ID you entered differs from the geodetic system employed in your chart or map, GPS fixes may be deviated from the actual position on the chart or map.

### ID Geodetic System

001:	W84:	WGS 84		
002:	W72:	WGS 72		
*003:	TOY-M:	TOKYO	(Go to 172)	:Mean Value (Japan, Korea & Okinawa)
004:	NAS-C:	NORTH AMERICAN 1927		:Mean Value
005:	EUR-M:	EUROPEAN 1950		:Mean Value
006:	AUG:	AUSTRALIAN GEODETIC 1984		:Australia and Tasmania Island
007:	ADI-M:	ADINDAN		:Mean Value (Ethiopia & Sudan)
008:	ADI-A:			:Ethiopia
009:	ADI-C:			:Mali
010:	ADI-D:			:Senegal
011:	ADI-B:			:Sudan
012:	AFG:	AFG		:Somalia
*013:	AIN-A:	AIN EL ABD 1970	(Go to 173)	:Bahrain Islands
014:	ANO:	ANNA 1 ASTRO 1965		:Cocos Island
015:	ARF-M:	ARC 1950		:Mean Value
016:	ARF-A:			:Botswana
017:	ARF-B:			:Lesotho
018:	ARF-C:			:Malawi
019:	ARF-D:			:Swaziland
020:	ARF-E:			:Zaire
021:	ARF-F:			:Zambia
022:	ARF-G:			:Zimbabwe
*023:	ARS-M:	ARC 1960	(Go to174)	:Mean Value (Kenya & Tanzania)
*024:	ARS-A:		(Go to 175)	:Kenya
*025:	ARS-B:		(Go to 176)	:Tanzania
*026:	ASC:	ASCENSION ISLAND 1958	(Go to177)	:Ascension Island
027:	ATF:	ASTRO BEACON "E"		:Iwo Jima Island
028:	TRN:	ASTRO B4 SOR. ATOLL		:Tern Island
029:	SHB:	ASTRO POS 71/4		:St. Helena Island
030:	ASQ:	ASTRONOMIC STATION 1952		:Marcus Island
031:	AUA:	AUSTRALIAN GEODETIC 1966		:Australia and Tasmania Island
032:	IBE:	BELLEVUE ( IGN )		:Efate and Erromango Islands
033:	BER:	BERMUDA 1957		:Bermuda Islands
034:	BOO:	BOGOTA OBSERVATORY		:Colombia
035:	CAI:	CAMPO INCHAUSPE		:Argentina
036:	CAO:	CANTON ISLAND 1966		:Phoenix Islands
037:	CAP:	CAPE		:South Africa
*038:	CAC:	CAPE CANAVERAL	(Go to 178)	:Mean Value (Florida & Bahama Islands)
039:	CGE:	CARTHAGE		:Tunisia
040:	CHI:	CHATHAM 1971		:Chatham Island (New Zealand)
041:	CHU:	CHUA ASTRO		:Paraguay
042:	COA:	CORREGO ALEGRE		:Brazil
043:	BAT:	DJAKARTA ( BATAVIA )		:Sumatra Island (Indonesia)
044:	GIZ:	DOS 1968		:Gizo Island (New Georgia Islands)
*045:	EAS:	EASTER ISLAND 1967	(Go to 179)	:Easter Island
046:	EUR-A:	EUROPEAN 1950		:Western Europe
047:	EUR-E:			:Cyprus
048:	EUR-F:			:Egypt
049:	EUR-G:			:England, Scotland, Channel, Scotland, & Shetland Islands
050:	EUR-K:			:England, Ireland, Scotland, & Shetland Islands
051:	EUR-B:			:Greece
052:	EUR-H:			:Iran

Specifications for GPS receiver GH-79L4

053:EUR-I:		:Italy--Sardinia
054:EUR-J:		:Italy--Sicily
055:EUR-C:		:Norway and Finland
*056:EUR-D:	(Go to 180)	:Portugal and Spain
057:EUS:	EUROPEAN 1979	:Mean Value
058:GAA:	GANDAJIKA BASE	:Republic of Maldives
059:GEO:	GEODETIC DATUM 1949	:New Zealand
060:GUA:	GUAM 1963	:Guam Island
061:DOB:	GUX 1 ASTRO	:Guadalcanal Island
062:HJO:	HJORSEY 1955	:Iceland
063:HKD:	HONG KONG 1963	:Hong kong
064:INF-A:	INDIAN	:Thailand and Vietnam
065:IND-B:		:Bangladesh, India, and Nepal
066:IRL:	IRELAND 1965	:Ireland
067:IST:	ISTS 073 ASTRO 1969	:Diego Garcia
*068:JOH:	JOHNSTON ISLAND 1961	(Go to 181) :Johnston Island
069:KAN:	KANDAWALA	:Sri Lanka
070:KEG:	KERGUELEN ISLAN	:Kerguelen Island
071:KEA:	KERTAU 1948	:West Malaysia and Singapore
072:REU:	LA REUNION	:Mascarene Island
073:LCF:	L.C. 5 ASTRO	:Cayman Brac Island
074:LIB:	LIBERIA 1964	:Liberia
075:LUZ-A:	LUZON	:Philippines (Excluding Mindanao Island)
076:LUZ-B:		:Mindanao Island
077:MIK:	MAHE 1971	:Mahe Island
078:SGM:	MARCO ASTRO	:Salvage Islands
079:MAS:	MASSAWA	:Eritrea (Ethiopia)
080:MER:	MERCHICH	:Morocco
081:MID:	MIDWAY ASTRO 1961	:Midway Island
082:MIN-B:	MINNA	:Nigeria
083:NAH-A:	NAHRWAN	:Masirah Island (Oman)
084:NAH-B:		:UnitedArab Emirates
*085:NAH-C:	(Go to 182)	:Saudi Arabia
086:SCK:	NAMIBIA	:Namibia
*087:NAP:	NAPARIMA, BWI	(Go to 183) :Trinidad and Tobago
088:NAS-B:	NORTH AMERICAN 1927	:Western United States
089:NAS-A:		:Eastern United States
090:NAS-D:		:Alaska
091:NAS-Q:	:Bahamas(Excluding San Salvador Island)	
092:NAS-R:		:Bahamas---San Salvador Island
093:NAS-E:		:Canada (Including Newfoundland Island)
094:NAS-F:		:Alberta and British Columbia
095:NAS-G:	:East Canada	
096:NAS-H:		:Manitoba and Ontario
097:NAS-I:		:Northwest Territories and Saskatchewan
098:NAS-J:		:Yukon
099:NAS-O:		:Canal Zone
*100:NAS-P:	(Go to 184)	:Caribbean
101:NAS-N:		:Central America
102:NAS-T:		:Cuba
103:NAS-U:		:Greenland
104:NAS-L:		:Mexico
105:NAR-A:	NORTH AMERICAN 1983	:Alaska
106:NAR-B:		:Canada
107:NAR-C:	:CONUS	
108:NAR-D:	:Mexico, Central America	
109:FLO:	OBSERVATORIO 1966	:Corvo and Flores Islands (Azores)
110:OEG:	OLD EGYPTIAN 1930	:Egypt
111:OHA-M:	OLD HAWAIIAN	:Mean Value
112:OHA-A:		:Hawaii
113:OHA-B:		:Kauai
114:OHA-C:		:Maui
*115:OHA-D:	(Go to 185)	:Oahu

Specifications for GPS receiver GH-79L4

116:FAH:	OMAN		:Oman
117:OGB-M:	ORDNANCE SURVEY OF GREAT BRITAIN	1936:	Mean Value
118:OGB-A:			:England
119:OGB-B:			:England, Isle of Man, and Wales
120:OGB-C:			:Scotland and Shetland Islands
121:OGB-D:			:Wales
122:PLN:	PICO DE LAS NIEVIES		:Canary Islands
123:PIT:	PITCAIRN ASTRO 1967		:Pitcairn Island
124:HIT:	PROVISIONAL SOUTH CHILEAN 1963		:South Chile (near 53°S)
125:PRP-M:	PROVISIONAL SOUTH AMERICAN 1956		:Mean Value
126:PRP-A:			:Bolivia
127:PRP-B:			:Chile---Northern Chile (near 19°S)
128:PRP-C:			:Chile---Southern Chile (near 43°S)
129:PRP-D:			:Colombia
130:PRP-E:			:Ecuador
131:PRP-F:			:Guyana
132:PRP-G:			:Peru
133:PRP-H:			:Venezuela
134:PUR:	PUERTO RICO		:Puerto Rico and Virgin Islands
135:QAT:	QATAR NATIONAL		:Qatar
136:QUO:	QORNOQ		:South Greenland
137:MOD:	ROME 1940		:Sardinia Islands
138:SAO:	SANTA BRAZ		:Sao Miguel, Santa Maria Islands (Azores)
139:SAE:	SANTO (DOS)		:Espirito Santo Island
*140:SAP:	SAPPER HILL 1943	(Go to 186)	:East Falkland Island
141:SAN-M:	SOUTH AMERICAN 1969		:Mean Value
142:SAN-A:			:Argentina
143:SAN-B:			:Bolivia
144:SAN-C:			:Brazil
145:SAN-D:			:Chile
146:SAN-E:			:Colombia
147:SAN-F:			:Ecuador
148:SAN-G:			:Guyana
149:SAN-H:			:Paraguay
150:SAN-I:			:Peru
151:SAN-K:			:Trinidad and Tobago
152:SAN-L:			:Venezuela
153:SOA:	SOUTH ASIA		:Singapore
154:POS:	SOUTHEAST BASE		:Porto Santo and Madeira Islands
155:GRA:	SOUTHWEST BASE		:Faial, Graciosa, Pico, Sao Jorge and Terceira Islands
*156:TIL:	TIMBALAI1948	(Go to 187)	:Brunei and East Malaysia (Sarawak and Sabah)
*157:TOY-A:	TOKYO	(Go to 188)	:Japan
*158:TOY-B:		(Go to 189)	:Korea
*159:TOY-C:		(Go to 190)	:Okinawa
160:TDC:	TRISTAN ASTRO 1968		:Tristan da Cunha
161:MVS:	VITI LEVU 1916		:Viti Levu Island ( Fiji Islands )
*162:ENW:	WAKE-ENIWETOK 1960	(Go to 191)	:Marshall Islands
163:ZAN:	ZANDERIJ		:Suriname
164:BUR:	BUKIT RIMPAH		:Bangka and Belitung Islands (Indonesia )
165:CAZ:	CAMP AREA ASTRO		:Camp McMurdo Area, Antarctica
166:GSE:	G. SEGARA		:Kalimantan Island ( Indonesia )
167:HEN:	HERAT NORTH		:Afghanistan
*168:HTN:	HU-TZU-SHAN	(Go to 192)	:Taiwan
169:TAN:	TANANARIVE OBSERVATORY 1925		:Madagascar
170:YAC:	YACARE		:Uruguay
171:999:	RT90		:Sweden
172:TOY-M:	TOKYO		:Mean Value (Japan, Korea,and Okinawa)
173:AIN-A:	AIN EL ABD 1970		:Bahrain Island
174:ARS-M:	ARC 1960		:Mean Value (Kenya, Tanzania)
175:ARS-A:			:Kenya
176:ARS-B:			:Tanzania

Specifications for GPS receiver GH-79L4

177:ASC:	ASCENSION ISLAND 1958	:Ascension Island
178:CAC:	CAPE CANAVERAL	:Mean Value (Florida and Bahama Islands)
179:EAS:	EASTER ISLANDS 1967	:Easter Island
180:EUR-D:	EUROPEAN 1950 (Cont'd)	:Portugal and Spain
181:JOH:	JHONSTON ISLAND 1961	:Jhonston Island
182:NAH-C:	NAHRWAN	:Saudi Arabia
183:NAP:	NAPARIMA, BWI	:Trinidad and Tobago
184:NAS-P:	NORTH AMERICAN 1927 (Cont'd)	:Caribbean
185:OHA-D:	OLD HAWAIIAN	:Oahu
186:SAP:	SAPPER HILL 1943	:East Falkland Island
187:TIL:	TIMBALAI 1948	:Brunei and East Malaysia (Sarawak and Sabah)
188:TOY-A:	TOKYO	:Japan
189:TOY-B:	TOKYO	:South Korea
190:TOY-C:	TOKYO	:Okinawa
191:ENW:	WAKE-ENIWETOK 1960	:Marshall Islands
192:HTN:	HU-TZU-SHAN	:Taiwan

193 through 200 are reserved

201:ADI-E:	ADINDAN	:Burkina Faso
202:ADI-F:	ADINDAN	:Cameroon
203:ARF-H:	ARC 1950	:Burundi
204:PHA:	AYABELLE LIGHTHOUSE	:Djibouti
205:BIJ:	BISSAU	:Guinea-Bissau
206:DAL:	DABOLA	:Guinea
207:EUR-T:	EUROPEAN 1950	:Tunisia
208:LEH:	LEIGON	:Ghana
209:MIN-A:	MINNA	:Cameroon
210:MPO:	M'PORALOKO	:Gabon
211:NSD:	NORTH SAHARA 1959	:Algeria
212:PTB:	POINT58	:Mean Solution (Burkina Faso and Niger)
213:PTN:	POINTE NOIRE 1948	:Congo
214:SRL:	SIERRA LEONE 1960	:Sierra Leone
215:VOR:	VOIROL 1960	:Algeria
216:AIN-B:	AIN EL ABD 1970	:Saudi Arabia
217:IND-B:	INDIAN	:Bangladesh
218:IND-I:	INDIAN	:India and Nepal
219:INF-A:	INDIAN 1954	:Thailand
220:ING-A:	INDIAN 1960	:Vietnam (near 16N)
221:ING-B:	INDIAN 1960	:Con Son Island (Vietnam)
222:INH-A:	INDIAN 1975	:Thailand
223:IDN:	INDONESIAN 1974	:Indonesia
224:EST:	CO-ORDINATE SYSTEM 1937 OF ESTONIA	:Estonia
225:EUR-L:	EUROPEAN 1950 (Cont'd)	:Malta
226:EUR-T:	EUROPEAN 1950 (Cont'd)	:Tunisia
227:SPK-A:	S-42 (PULKOVO 1942)	:Hungary
228:SPK-B:	S-42 (PULKOVO 1942)	:Poland
229:SPK-C:	S-42 (PULKOVO 1942) (Cont'd)	:Czechoslovakia
230:SPK-D:	S-42 (PULKOVO 1942) (Cont'd)	:Latvia
231:SPK-E:	S-42 (PULKOVO 1942) (Cont'd)	:Kazakhstan
232:SPK-F:	S-42 (PULKOVO 1942) (Cont'd)	:Albania
233:SPK-G:	S-42 (PULKOVO 1942) (Cont'd)	:Romania
234:CCD:	S-JTSK	:Czechoslovakia
235:NAS-V:	NORTH AMERICAN 1927 (Cont'd)	:East of 180W
236:NAS-W:	NORTH AMERICAN 1927 (Cont'd)	:West of 180W
237:NAR-E:	NORTH AMERICAN 1983	:Aleutian Island
238:NAR-H:	NORTH AMERICAN 1983	:Hawaii
239:SAN-J:	SOUTH AMERICAN 1969 (Cont'd)	:Baltra, Galapagos Island
240:AIA:	ANTIGUA ISLAND ASTRO 1943	:Antigua, Leeward Island
241:DID:	DECEPTION ISLAND	:Deception Island, Antarctica
242:FOT:	FORT THOMAS 1955	:Nevis, St. Kitts, Leeward Island
243:ISG:	ISTS 061 ASTRO 1968	:South Georgia Island

## Specifications for GPS receiver GH-79L4

244:ASM:	MONTSERRAT ISLAND ASTRO 1958	:Montserrat, Leeward Island
245:REU:	REUNION	:Mascarene Island
246:AMA:	AMERICAN SAMOA 1962	:American Samoa Island
247:IDN:	INDONESIAN 1974	:Indonesia
248:KUS:	Kusaie ASTRO 1951	:Caroline Island, Fed.States of Micronesia
249:WAK:	Wake Island ASTRO 1952	:Wake Atoll
250:EUR-S:	EUROPEAN 1950	:Iraq, Israel, Jordan, Kuwait, Lebanon, Saudi Arabia and Syria
251:HER:	HERMANNSKOGEL	:Yugoslavia (Prior to 1990) Slovenia, Croatia, Bosnia and Herzegovina Serbia
252:IND-P:	INDIAN	:Pakistan
253:PUK:	PULKOVO 1942	:Russia
254:VOI:	VOIROL 1874	:Tunisia/Algeria

## 5. Intermittent Operation Mode

### 5.1 Overall of Intermittent Operation Mode

While a receiver is at normal operation mode, the operation mode of the receiver can be switched to “Intermittent Operation Mode” with a “GPsp” command. Refer to the following chart for an operation sequence.

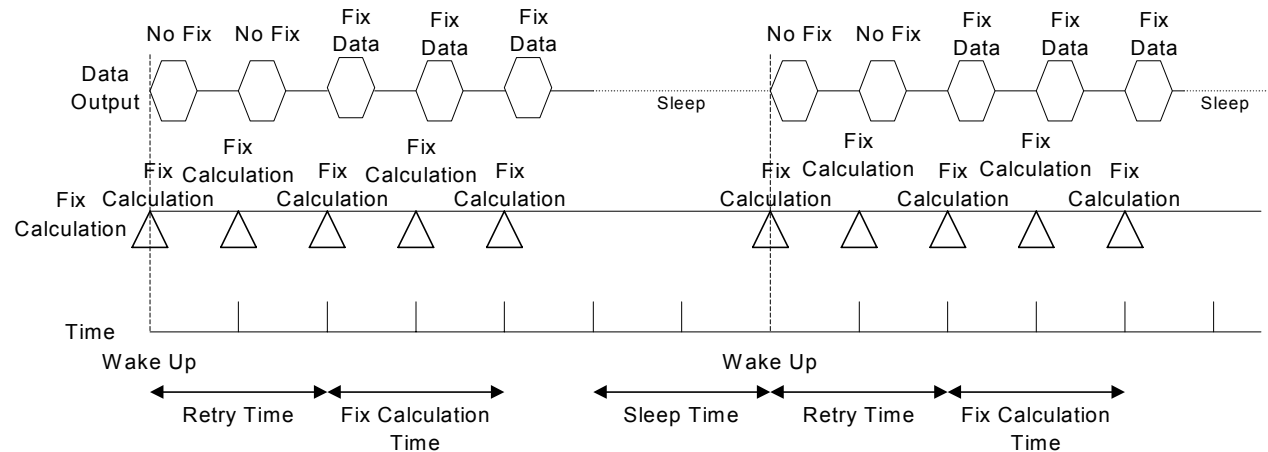

*Fig-1. Overall Sequence of Intermittent Operation Mode*

- Sleep time : Defines sleep time at intermittent operation mode. Valid input is 0 and from 1 to 60, where 0 represents continuous position calculation and other represents sleep time in seconds.
- Retry time : Defines retry time till fix after the receiver recovers from sleep. Valid input is from 3 to 127 and it represents seconds. The receiver returns to sleep after retrying and attempting a position calculation for the defined seconds.
- Calculation time : Defines continuous fix calculation time from a successful fix after the receiver recovered from sleep. Valid input is from 1 to 60 and it represents seconds.

## 5.2 Recovery From Sleep to Position Calculation

After a recovery from sleep, the receiver starts acquiring satellites for position fix calculation. The receiver retries the calculation till it obtains the position or defined retry time expires. At the retry time expiry, the receiver returns to sleep.

The duration of retry time can be set from 3 to 127 seconds.

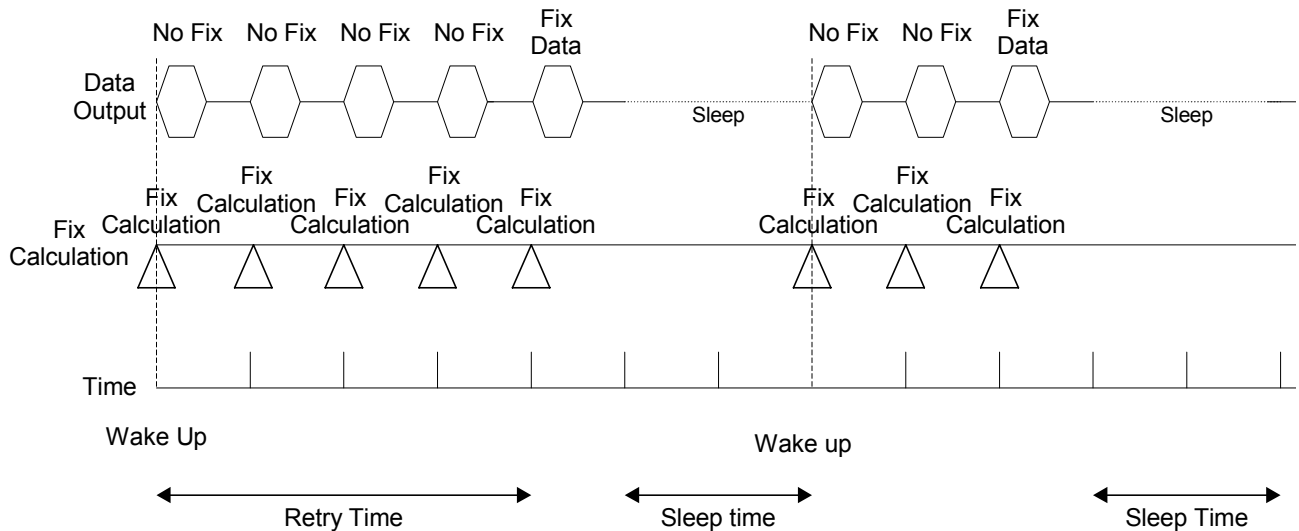
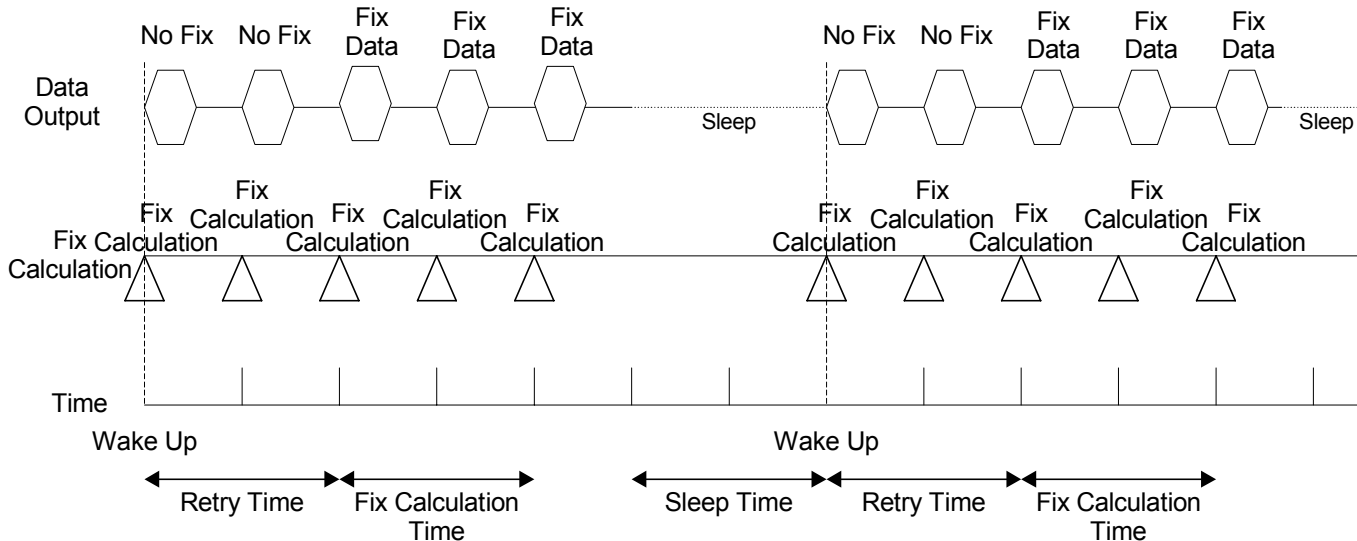

*Fig-2. Recovery From Sleep to Position Calculation*



### 5.3 Position Calculation after successful fix

After a successful position fix after receiver has been recovered from sleep, the receiver continuously calculates the position for defined continuous calculation time then it puts itself to a sleep. The duration of the continuous calculation time can be set from 1 to 60 seconds.



*Fig-3. Position Calculation After Successful Fix*

### 5.4 Changing Operational Mode to Normal Mode

While the receiver is at intermittent operation mode and it is at sleep, input of “Wake up” signal changes the receiver to normal operation mode. The wake up signal should be applied twice with more than one second interval while the receiver is at sleep.

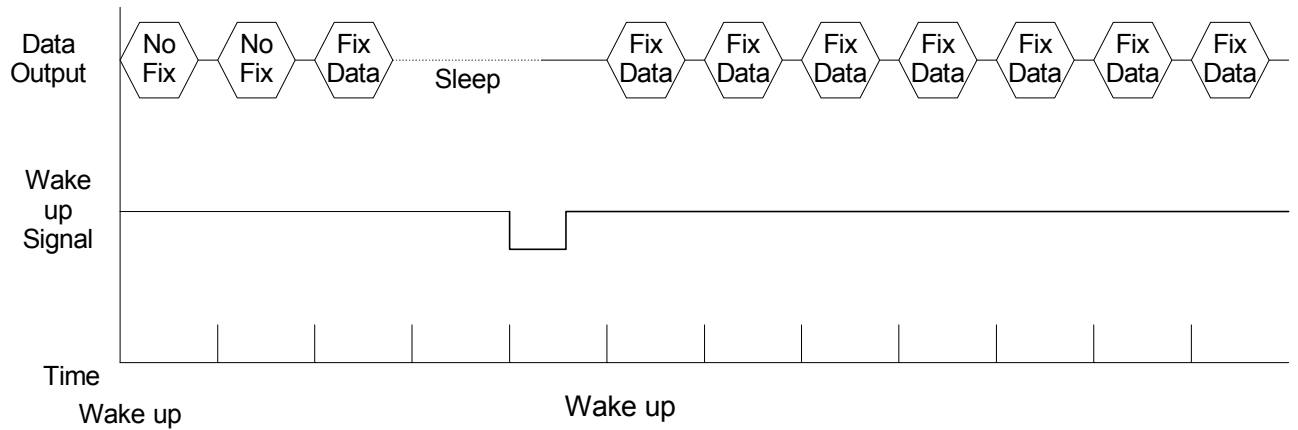

*Fig-4. Changing Operational Mode to Normal*

### Specifications for Wake up signal

The wake up signal should be applied twice with interval more than one second while the receiver is at sleep.

The pulse width “A” should be greater than 1 us but smaller than 10 us. The interval “B” between two pulses should be greater than 1 second and smaller that 2 seconds.

$$1 \text{ us} \leq A \leq 10 \text{ us}$$

$$1 \text{ s} \leq B \leq 2 \text{ s}$$

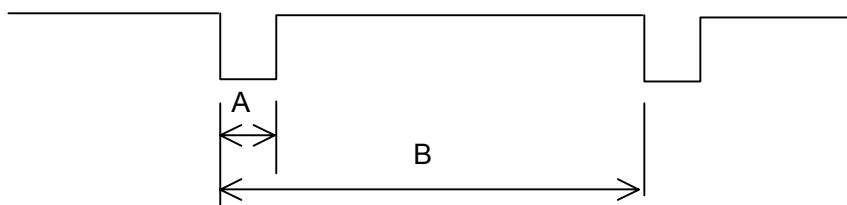

*Fig-5. Wake Up Signal*

### 5.5 Obtaining the First Fix and Ephemeris Update

A receiver will not put itself into sleep till first fix is obtained after the power is turned on or while an ephemeris is been updated. To have ephemeris updated automatically, the function needs to be enabled. Refer to “GPslp” command field description for detail of the activation.

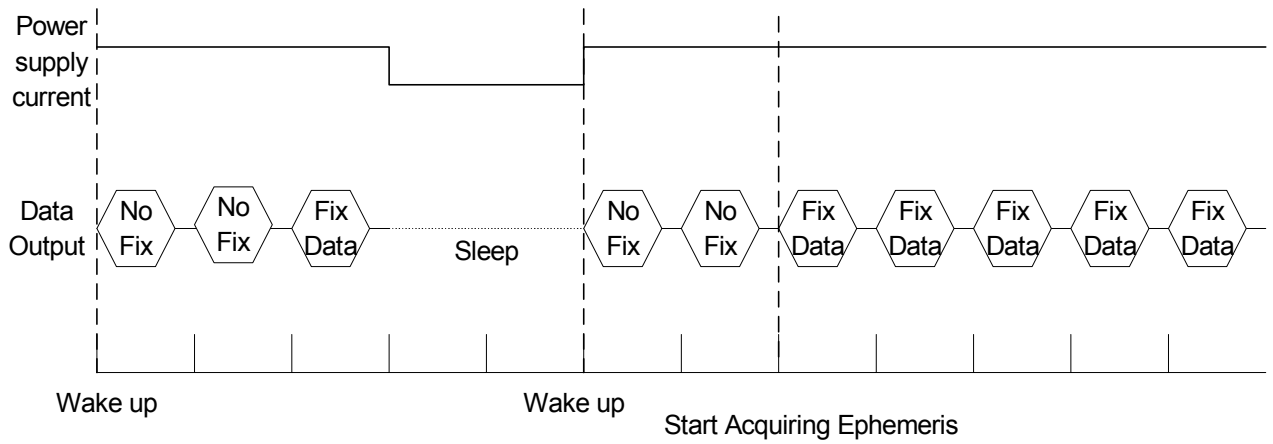

*Fig-6. Data Output While Obtaining First Fix and During Ephemeris Update*

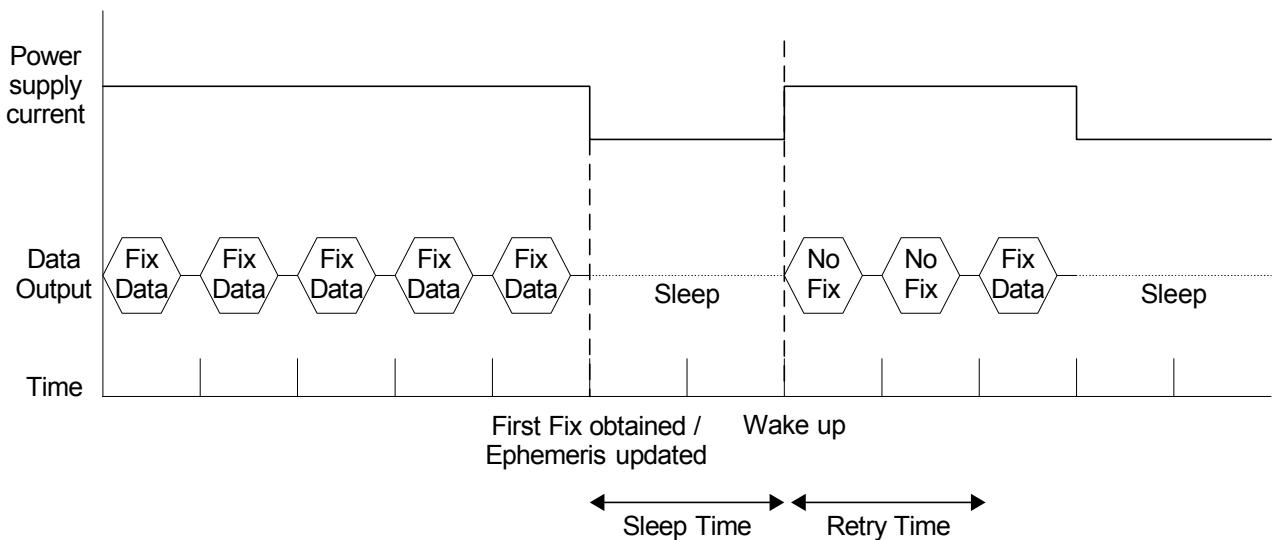

*Fig-7. Data Output After the First Fix and Ephemeris Update*

### 5.6 Intermittent Operation Status Output

At acceptance of the intermittent operation command “GPslp”, the receiver sends back an intermittent operation status “GPslp”. Please note that in case the receiver has been set to transmit more than 480 bytes per second, there may be no room for the status to be transmitted. Refer to section 3.5 (5) “Setting Data Transmission Interval” for more information.

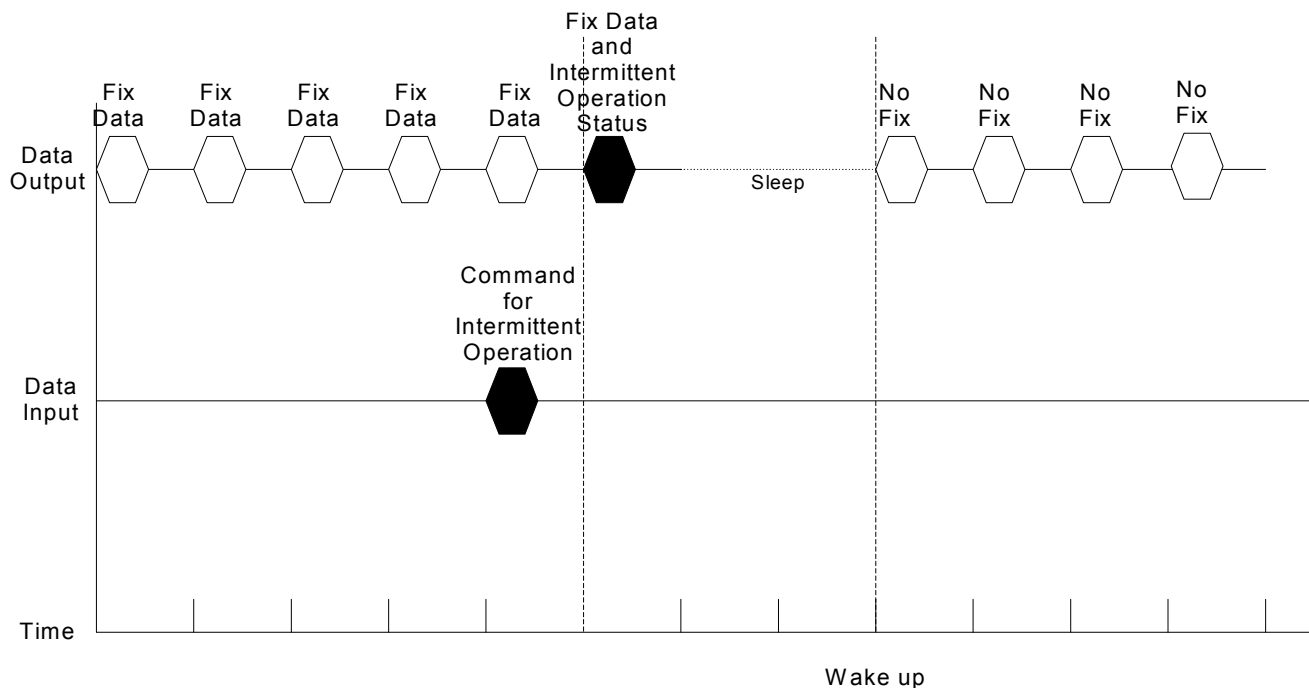
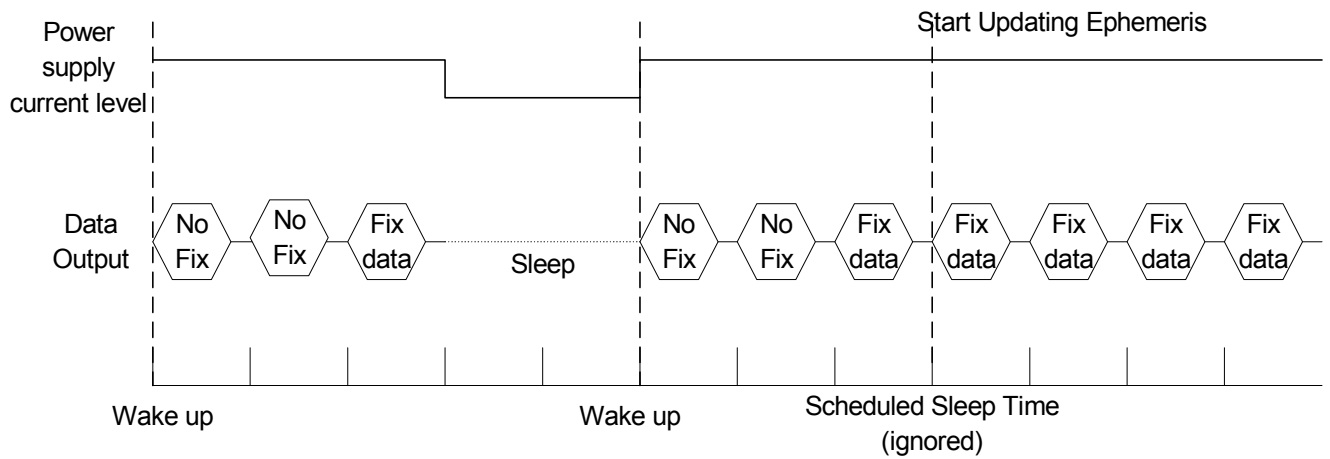

*Fig-8. Intermittent Operation Status Output*

### 5.7 Command Acceptance During Sleep

The receiver will not accept any command during sleep. All commands should be sent while it is awake which can be determined by data transmission or after switching the operation mode to normal mode with “Wake Up” signal.

### 5.8 Automatic Ephemeris Update



*Fig-9. Ignored Scheduled Sleep at Ephemeris Update*

When automatic Ephemeris update is activated and the Ephemeris data in the receiver is more than 2 hours old, the receiver will automatically update the Ephemeris and will not put itself into sleep until its completion. The receiver will go into sleep at next scheduled sleep timing after the update is successfully completed.

Refer to the following flow chart for overall operation of intermittent operation mode.

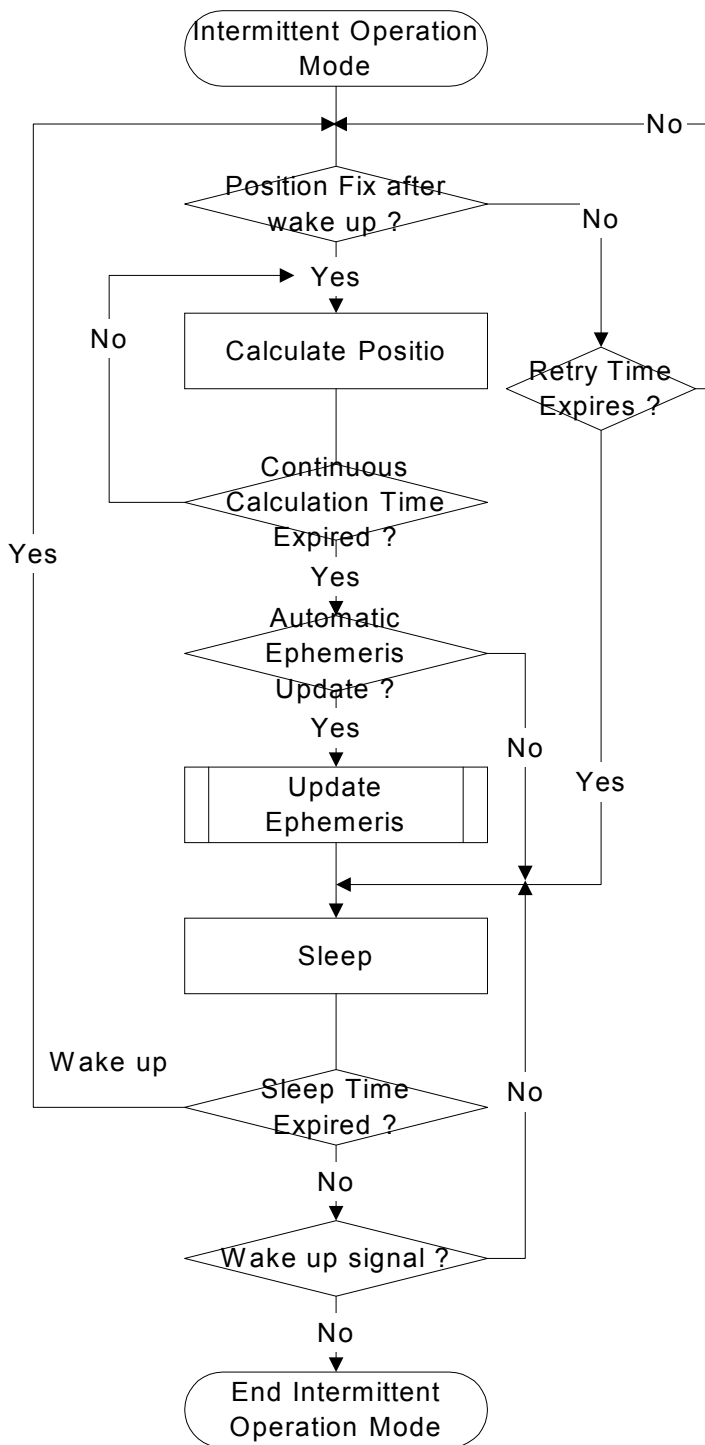

*Fig-10. Overall Operation of Intermittent Operation Mode*

## 6. Autonomous start with ROM Almanac

The receiver has Almanac on its ROM to be used at autonomous start. With a usage of ROM Almanac, it saves time for receiver to search for available satellites and enables faster position fix compared to ordinary autonomous start without using ROM Almanac.

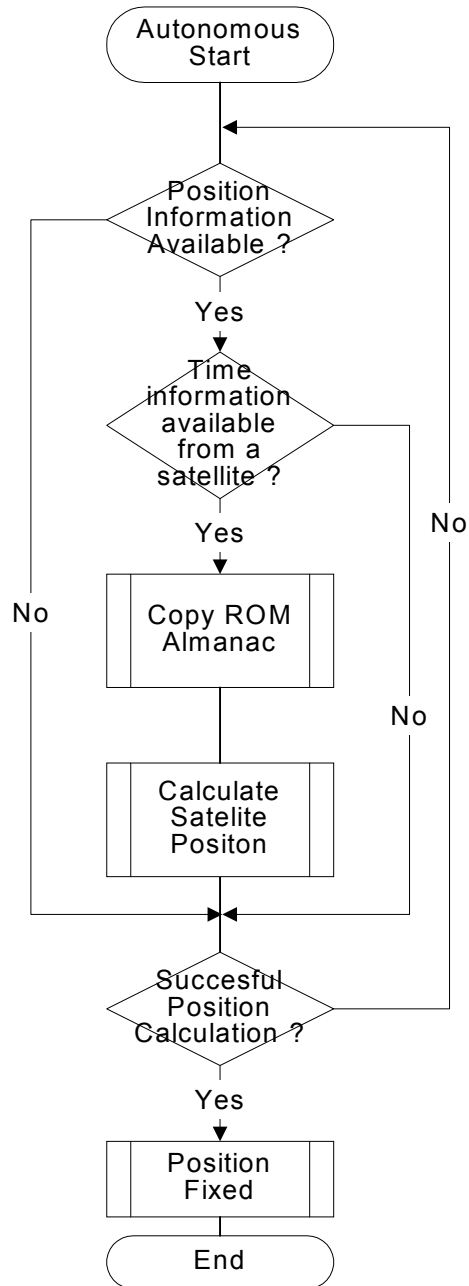

*Fig-11. Flow Chart for Usage of ROM Almanac at Autonomous Start*