

# DURACELL

PHOTO

# ULTRA

# Ultra 123

## Lithium/Manganese Dioxide

Li/MnO<sub>2</sub>

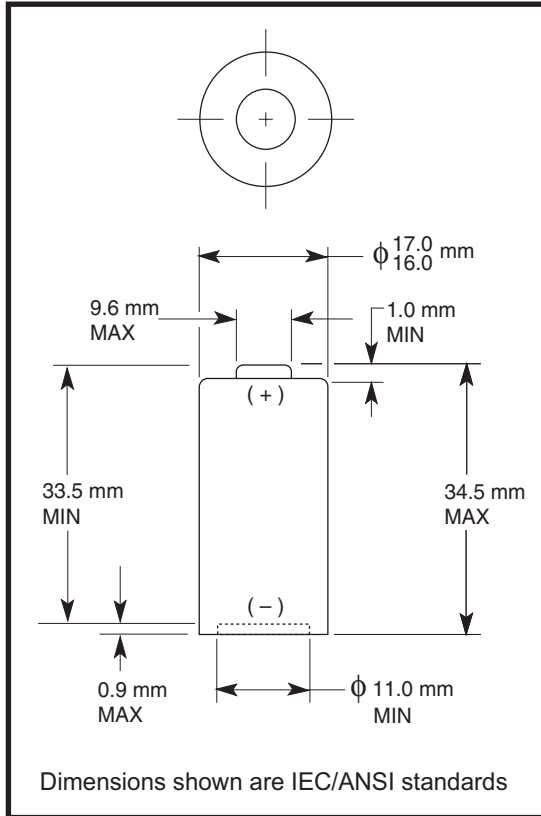

<b>Nominal Voltage:</b>	3.0 V
<b>Typical Voltage:</b>	3.2-3.3 V
<b>Nominal Internal Impedance:</b>	0.25 ohm @ 1kHz
<b>Average Weight:</b>	17.0 gm
<b>Volume:</b>	7.18 cm <sup>3</sup>
<b>Terminals:</b>	Flat, Recessed Negative Terminal, Nickel Plated Steel
<b>Operating Temperature Range:</b>	-20°C to 75°C (-4°F to 167°F)
<b>ANSI:</b>	5018LC
<b>IEC:</b>	CR17345

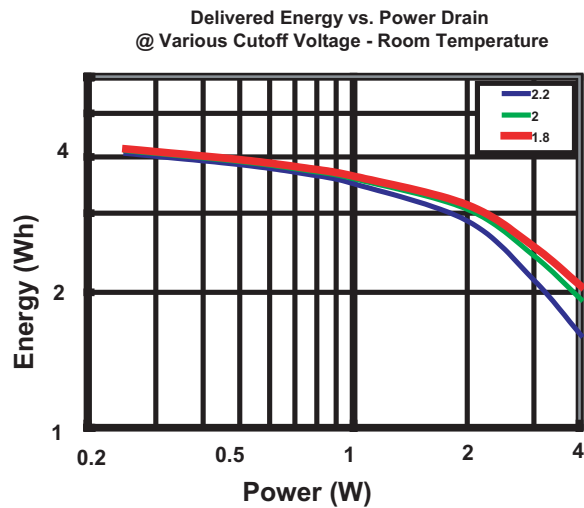

### Duracell Ultra 123 Typical Performance

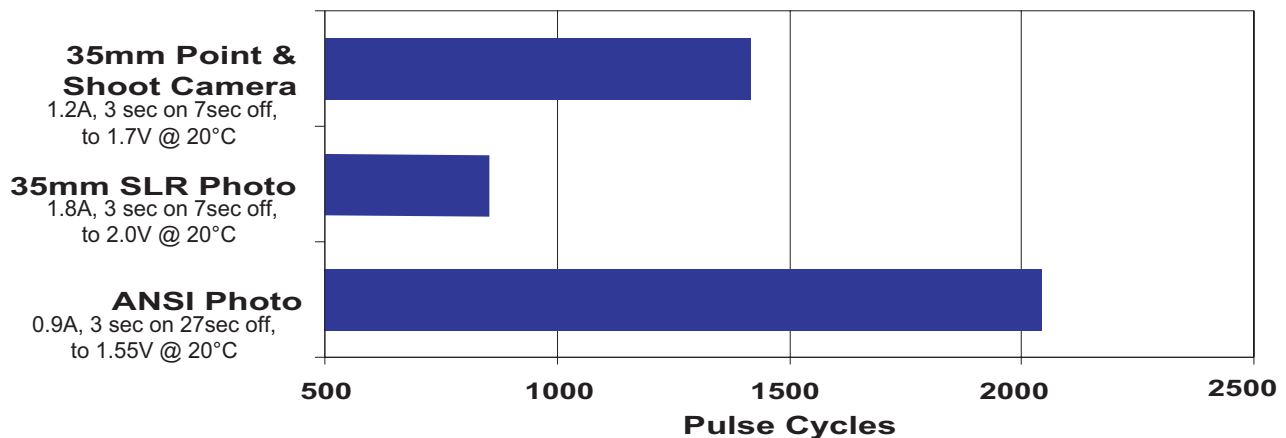

\* Delivered capacity is dependent on the applied load, operating temperature and cut-off voltage. Please refer to the charts and discharge data shown for examples of the energy / service life that the battery will provide for various load conditions.

1.8 Amp 3 sec on/ 7 sec off  
@ Various Temperatures

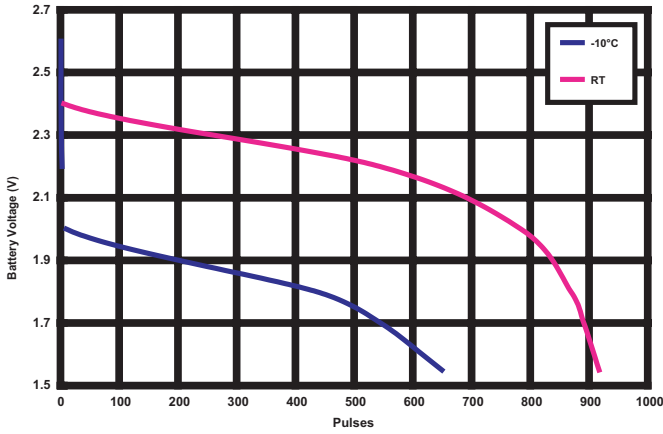

1.2 Amp, 3 sec on/ 7 sec off  
@ Various Temperatures

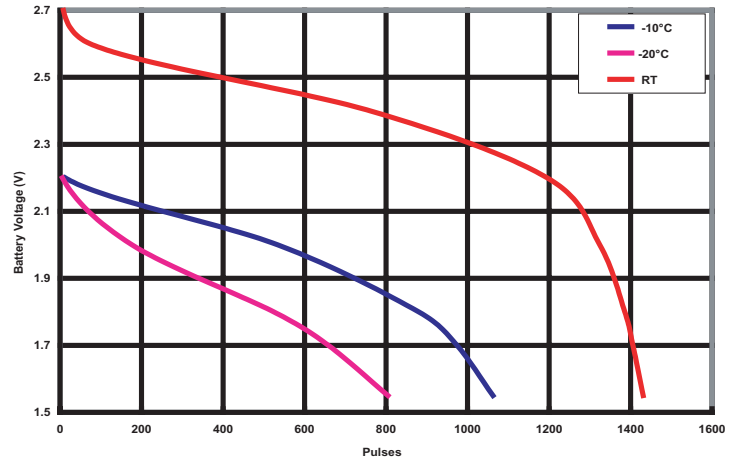

Continuous Discharge  
RT to 1.55 Volts

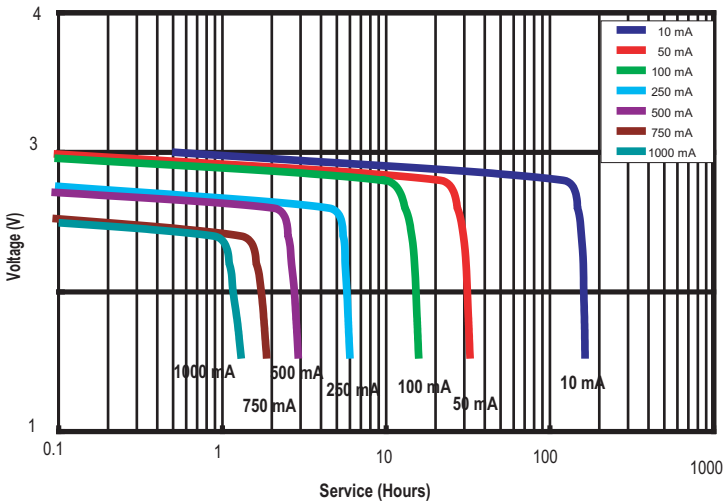

0.9 Amp, 3 sec on/27 sec off  
@ Various Temperatures

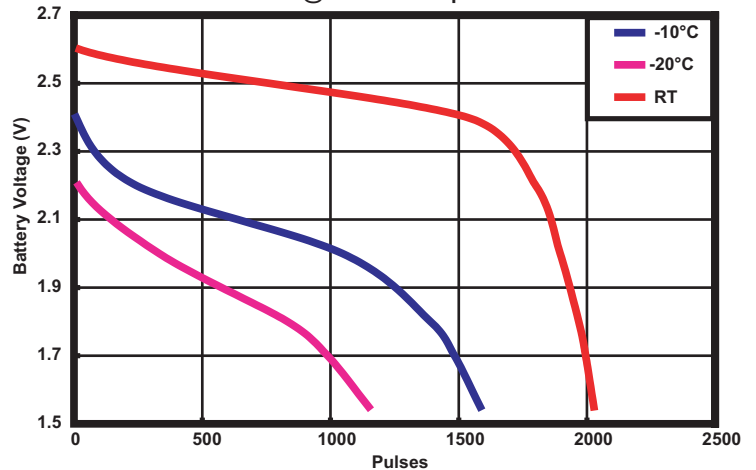

## DURACELL®

BATTERIES

Berkshire Corporate Park  
Bethel, CT 06801 U.S.A.  
Telephone: Toll-free 1-800-544-5454  
Internet: [www.duracell.com](http://www.duracell.com)

\* Delivered capacity is dependent on the applied load, operating temperature and cut-off voltage. Please refer to the charts and discharge data shown for examples of the energy / service life that the battery will provide for various load conditions.