

SIFERRIT® Materials

Based on IEC 60401, the data specified here are typical data for the material in question, which have been determined principally on the basis of toroids (ring cores).

The purpose of such characteristic material data is to provide the user with improved means for comparing different materials.

There is no direct relationship between characteristic material data and the data measured using other core shapes and/or core sizes made of the same material. In the absence of further agreements with the manufacturer, only those specifications given for the core shape and/or core size in question are binding.

1 Material application survey

Usage	Frequency range	Material	Specific application	Core type
High Q inductors in resonant circuits and filters	up to 0,1 MHz	N 48	Filters in telephony, MW IF filters	Gapped P and RM cores, adjusting cores
	0,2 – 1,6 MHz	M 33		
	1,5 – 12 MHz	K 1		
Broadband transformers (e.g. antenna transformers, ISDN transformers, digital data transformers (xDSL, LAN))	up to 3 MHz	T 56	Impedance and matching transformers (ISDN, xDSL using paired core shapes with air gap)	Toroids
		T 46		EP, RM, TT/PR, toroids
		T 42		
		T 38		
	up to 5 MHz	N 26	Radio-frequency transformers	Double aperture, toroids
	up to 10 MHz	M 33		
	up to 100 MHz	T 57	LAN (also suitable for xDSL in paired core shapes)	Toroids
up to 100 MHz	M 33	Balun transformers	Double aperture, toroids	
	K 1			
Electromagnetic Interference (EMI)	up to 3 MHz	T 38	Current-compensated chokes	DE, toroids
		T 37		
		T 35		
		T 65		
	up to 5 MHz	N 30		
	up to 100 MHz	M 13	Line attenuation, current-compensated chokes	Toroids
		K 6		
		K 7		
		K 8		
K 10				
Sensors, ID systems	up to 1 MHz	N 22	Inductive proximity switches	P core halves
	up to 2 MHz	M 33		
	up to 100 MHz	FPC		

SIFERRIT Materials

Usage	Frequency range	Material	Specific application	Core type
Medium and high frequency switch-mode power supplies	up to 100 kHz	N 27	Power transformers and chokes	E, ETD, ER, EFD, EV, ELP, RM, RM LP, PM
	up to 500 kHz	N 87		
		N 97		
	300 kHz to 1 MHz	N 49		
	up to 100 kHz	N 41	Chokes	E, ETD, ER, EFD, EV, ELP, RM, RM LP, PM
	up to 500 kHz	N 92	High voltage transformers and power chokes	
up to 200 kHz	N 72	Electronic lamp ballast devices	E, ETD	

LP = Low Profile

2 Material properties

Preferred application			Resonant Circuit inductors			Inductors for line attenuation	
Material			K 1	M 33 ¹⁾	N 48	K 10	K 8
Base material			NiZn	MnZn	MnZn	NiZn	NiZn
Color code (adjuster)			violet	white	—	—	—
	Symbol	Unit					
Initial permeability ($T = 25\text{ °C}$)	μ_i		80 $\pm 25\%$	750 $\pm 25\%$	2300 $\pm 25\%$	800 $\pm 25\%$	860 $\pm 25\%$
Meas. field strength	H	A/m	5000	2000	1200	5000	1200
Flux density (near saturation) ($f = 10\text{ kHz}$)	$B_S(25\text{ °C})$ $B_S(100\text{ °C})$	mT mT	310 280	400 310	420 310	320 240	340 240
Coercive field strength ($f = 10\text{ kHz}$)	$H_C(25\text{ °C})$ $H_C(100\text{ °C})$	A/m A/m	380 350	80 65	26 19	40 25	40 25
Optimum frequency range	f_{\min} f_{\max}	MHz	1,5 ... 12	0,2 ... 1,0	0,001 ... 0,1	0,1 ... 1	0,1 ... 0,5
Relative loss factor at f_{\min} at f_{\max}	$\tan \delta/\mu_i$	10^{-6} 10^{-6}	< 40 < 120	< 12 < 20	< 2,7 < 4,2	< 15 < 60	< 20 < 30
Hysteresis material constant	η_B	$10^{-6}/\text{mT}$	< 36	< 1,8	< 0,4	< 5	< 4,5
Curie temperature	T_C	°C	> 400	> 200	> 170	> 150	> 150
Relative temperature coefficient at 25 ... 55 °C at 5 ... 25 °C	α_F	$10^{-6}/\text{K}$	2 ... 8 7 ... 1	0,5 ... 2,6 —	0,3 ... 1,3 0,3 ... 1,3	— —	— —
Mean value of α_F at 25 ... 55 °C		$10^{-6}/\text{K}$	4	1,6	0,70	10,0	9,2
Density (typical values)		kg/m^3	4650	4500	4700	5000	5100
Disaccommodation factor at 25 °C	DF	10^{-6}	20	8	2	—	—
Resistivity	ρ	Ωm	10^5	5	3	10^5	10^5
Core shapes			RM, P, Toroid, P core half	RM, P, Toroid, Double-aperture, P core-half	RM, P	Toroid, Double-aperture	Toroid
Other material properties (graphs) see page			50	57	70	55	54

1) For threaded cores $\mu_i = 600 \pm 20\%$

Material properties (continued)

Preferred application			Inductors for line attenuation			Proximity switch	
Material			K 6	K 7	M 13	N 22	
Base material			NiZn	NiZn	NiZn	MnZn	
Color code (adjuster)			—	—	—	red	
	Symbol	Unit					
Initial permeability ($T = 25\text{ °C}$)	μ_i		1000 $\pm 25\%$	1500 $\pm 25\%$	2300 $\pm 25\%$	2300 $\pm 25\%$	
Meas. field strength	H	A/m	1200	1200	1200	1200	
Flux density (near saturation) ($f = 10\text{ kHz}$)	$B_S (25\text{ °C})$	mT	270	280	280	370	
	$B_S (100\text{ °C})$	mT	180	150	135	260	
Coercive field strength ($f = 10\text{ kHz}$)	$H_C (25\text{ °C})$	A/m	43	24	12	18	
	$H_C (100\text{ °C})$	A/m	32	17	8	14	
Optimum frequency range	f_{\min}	MHz	0,1 ...	0,1 ...	0,001 ...	0,001 ...	
	f_{\max}		0,5	0,5	0,1	0,2	
Relative loss factor	at f_{\min} at f_{\max}	$\tan \delta/\mu_i$	10^{-6}	< 20	< 15	< 5	< 2
			10^{-6}	< 40	< 60	< 20	< 20
Hysteresis material constant	η_B	$10^{-6}/\text{mT}$	< 4,0	< 4,0	< 4,0	< 1,4	
Curie temperature	T_C	$^{\circ}\text{C}$	> 130	> 110	> 105	> 145	
Relative temperature coefficient at 25 ... 55 $^{\circ}\text{C}$ at 5 ... 25 $^{\circ}\text{C}$	α_F	$10^{-6}/\text{K}$	—	—	—	—	
			—	—	—	—	
Mean value of α_F at 25 ... 55 $^{\circ}\text{C}$		$10^{-6}/\text{K}$	3,7	3,5	3,7	0,9	
Density (typical values)		kg/m^3	5100	5150	5200	4700	
Disaccommodation factor at 25 $^{\circ}\text{C}$	DF	10^{-6}	—	—	—	4	
Resistivity	ρ	Ωm	10^7	$5 \cdot 10^6$	10^5	1	
Core shapes			Toroid	Toroid	Toroid, Double-aperture	P core half	
Other material properties (graphs) see page			52	53	56	59	

SIFERRIT Materials

Material properties (continued)

Preferred application			Broadband transformers				
Material			N 26	T 57	N 30	T 65	
Base material			MnZn	MnZn	MnZn	MnZn	
	Symbol	Unit					
Initial permeability ($T = 25\text{ °C}$)	μ_i		2300 $\pm 25\%$	4000 $\pm 25\%$	4300 $\pm 25\%$	5200 $\pm 30\%$	
Meas. field strength	H	A/m	1200	1200	1200	1200	
Flux density (near saturation) ($f = 10\text{ kHz}$)	$B_S(25\text{ °C})$	mT	380	430	380	460	
	$B_S(100\text{ °C})$	mT	260	270	240	320	
Coercive field strength ($f = 10\text{ kHz}$)	$H_c(25\text{ °C})$	A/m	23	14	12	12	
	$H_c(100\text{ °C})$	A/m	17	12	8	11	
Optimum frequency range	f_{\min}	MHz	0,001 ...	0,01 ...	0,01 ...	0,01 ...	
	f_{\max}		0,1	0,5	0,40	0,20	
Relative loss factor	at f_{\min}	$\tan \delta/\mu_i$	10^{-6}	< 2,8	< 5	< 2	< 1,5
	at f_{\max}		10^{-6}	< 3,8	< 70	< 60	< 25
Hysteresis material constant	η_B	$10^{-6}/\text{mT}$	< 0,3	< 0,3	< 1,1	< 1,1	
Curie temperature	T_C	$^{\circ}\text{C}$	> 130	> 140	> 130	> 160	
Relative temperature coefficient at 25 ... 55 $^{\circ}\text{C}$	α_F	$10^{-6}/\text{K}$	0 ... 1,5	—	—	—	
			0 ... 1,8	—	—	—	
Mean value of α_F at 25 ... 55 $^{\circ}\text{C}$		$10^{-6}/\text{K}$	1,0	0,5	0,6	- 0,5	
Density (typical values)		kg/m^3	4700	4930	4800	4930	
Disaccommodation factor at 25 $^{\circ}\text{C}$	DF	10^{-6}	—	—	—	—	
Resistivity	ρ	Ωm	2	3	0,5	0,30	
Core shapes			RM, P, EP	RM, P, EP, Toroid	RM, P, EP, E, Toroid, Double- aperture	RM, P, Toroid, EP	
Other material properties (graphs) see page			60	102	65	104	

SIFERRIT Materials
Material properties (continued)

Preferred application			Broadband transformers		
Material			T 35	T 37	T 38 ¹⁾
Base material			MnZn	MnZn	MnZn
	Symbol	Unit			
Initial permeability ($T = 25\text{ °C}$)	μ_i		6000 $\pm 25\%$	6500 $\pm 25\%$	10000 $\pm 30\%$
Meas. field strength	H	A/m	1200	1200	1200
Flux density (near saturation) ($f = 10\text{ kHz}$)	$B_S (25\text{ °C})$	mT	390	380	430
	$B_S (100\text{ °C})$	mT	270	240	260
Coercive field strength ($f = 10\text{ kHz}$)	$H_C (25\text{ °C})$	A/m	12	9	8
	$H_C (100\text{ °C})$	A/m	9	8	7
Optimum frequency range	f_{\min}	MHz	0,01 ...	0,01 ...	0,01 ...
	f_{\max}		0,20	0,30	0,10
Relative loss factor	at f_{\min} at f_{\max}	$\tan \delta/\mu_i$	10^{-6}	< 2	$< 2,0$
			10^{-6}	< 60	< 20
Hysteresis material constant	η_B	$10^{-6}/\text{mT}$	$< 1,1$	$< 1,1$	$< 0,3$
Curie temperature	T_C	$^{\circ}\text{C}$	> 130	> 130	> 130
Relative temperature coefficient at 25 ... 55 $^{\circ}\text{C}$ at 5 ... 25 $^{\circ}\text{C}$	α_F	$10^{-6}/\text{K}$	—	—	—
			—	—	—
Mean value of α_F at 25 ... 55 $^{\circ}\text{C}$		$10^{-6}/\text{K}$	0,8	-0,3	-0,2
Density (typical values)		kg/m^3	4900	4900	4950
Disaccommodation factor at 25 $^{\circ}\text{C}$	DF	10^{-6}	—	—	—
Resistivity	ρ	Ωm	0,2	0,2	0,1
Core shapes			RM, P, EP, Toroid	Toroid, DE	RM, P, EP, ER, Toroid, TT/PR, E
Other material properties (graphs) see page			90	92	94

1) Improved, new data

SIFERRIT Materials
Material properties (continued)

Preferred application			Broadband transformers		
Material			T 42 ¹⁾	T 46 ¹⁾	T 56 ¹⁾
Base material			MnZn	MnZn	MnZn
	Symbol	Unit			
Initial permeability ($T = 25\text{ °C}$)	μ_i		12000 $\pm 30\%$	15000 $\pm 30\%$	20000 $\pm 30\%$
Meas. field strength	H	A/m	1200	1200	400
Flux density (near saturation) ($f = 10\text{ kHz}$)	$B_S (25\text{ °C})$	mT	400	400	350
	$B_S (100\text{ °C})$	mT	250	240	250
Coercive field strength ($f = 10\text{ kHz}$)	$H_c (25\text{ °C})$	A/m	7	7	6
	$H_c (100\text{ °C})$	A/m	6	6	5
Optimum frequency range	f_{\min}	MHz	0,01 ...	0,01 ...	0,01 ...
	f_{\max}		0,10	0,10	0,10
Relative loss factor	at f_{\min} at f_{\max}	$\tan \delta/\mu_i$	10^{-6}	< 2	< 8
			10^{-6}	< 20	< 100
Hysteresis material constant	η_B	$10^{-6}/\text{mT}$	< 1,4	< 2,0	< 1,5
Curie temperature	T_C	$^{\circ}\text{C}$	> 130	> 130	> 90
Relative temperature coefficient at 25 ... 55 $^{\circ}\text{C}$ at 5 ... 25 $^{\circ}\text{C}$	α_F	$10^{-6}/\text{K}$	—	—	—
			—	—	—
Mean value of α_F at 25 ... 55 $^{\circ}\text{C}$		$10^{-6}/\text{K}$	-0,3	-0,6	0,22
Density (typical values)		kg/m^3	4950	5000	5040
Disaccommodation factor at 25 $^{\circ}\text{C}$	DF	10^{-6}	—	—	—
Resistivity	ρ	Ωm	0,1	0,01	0,1
Core shapes			RM, EP	Toroid	Toroid
Other material properties (graphs) see page			96	98	100

1) Material values defined on the basis of small toroids ($\leq R10$)

SIFERRIT Materials

Material properties (continued)

Preferred application			Power transformers			
Material			N 49 ¹⁾	N 92	N 27	N 67 ²⁾
Base material			MnZn	MnZn	MnZn	MnZn
	Symbol	Unit				
Initial permeability ($T = 25\text{ °C}$)	μ_i		1500 $\pm 25\%$	1500 $\pm 25\%$	2000 $\pm 25\%$	2100 $\pm 25\%$
Flux density ($H = 1200\text{ A/m}$, $f = 10\text{ kHz}$)	$B_S (25\text{ °C})$	mT	490	500	500	480
	$B_S (100\text{ °C})$	mT	400	440	410	380
Coercive field strength ($f = 10\text{ kHz}$)	$H_C (25\text{ °C})$	A/m	38	24	23	20
	$H_C (100\text{ °C})$	A/m	33	13	19	14
Typical frequency range		kHz	300 ... 1000	25 ... 500	25 ... 150	25 ... 300
Hysteresis material constant	η_B	$10^{-6}/\text{mT}$	< 0,4	< 1,4	< 1,5	< 1,4
Curie temperature	T_C	°C	> 240	> 280	> 220	> 220
Mean value of α_F at 25 ... 55 °C		$10^{-6}/\text{K}$	—	—	3	4
Density (typical values)		kg/m ³	4800	4850	4750	4800
Relative core losses (typical values)	P_V					
25 kHz, 200 mT, 100 °C		kW/m ³	—	70	155	80
100 kHz, 200 mT, 100 °C		kW/m ³	—	410	920	525
300 kHz, 100 mT, 100 °C		kW/m ³	330	410	—	560
500 kHz, 50 mT, 100 °C		kW/m ³	80	230	—	—
1 MHz, 50 mT, 100 °C	kW/m ³	475	—	—	—	
Resistivity	ρ	Ωm	17	8	3	6
Core shapes			RM, EFD, ELP, Toroid	RM, ETD, EFD, ER, E, ELP, Toroid	P, PM, ETD, EC, ER, E, U, Toroid	ETD, EFD, E
Other material properties (graphs) see page			72	84	62	75

1) Improved, new data

2) Not for new design

SIFERRIT Materials

Material properties (continued)

Preferred application			Power transformers			
Material			N 87 ¹⁾	N 97	N 72	N 41
Base material			MnZn	MnZn	MnZn	MnZn
	Symbol	Unit				
Initial permeability ($T = 25\text{ °C}$)	μ_i		2200 $\pm 25\%$	2300 $\pm 25\%$	2500 $\pm 25\%$	2800 $\pm 25\%$
Flux density ($H = 1200\text{ A/m}$, $f = 10\text{ kHz}$)	$B_S(25\text{ °C})$	mT	490	510	480	490
	$B_S(100\text{ °C})$	mT	390	410	370	390
Coercive field strength ($f = 10\text{ kHz}$)	$H_c(25\text{ °C})$	A/m	21	21	15	22
	$H_c(100\text{ °C})$		13	12	11	20
Typical frequency range		kHz	25 ... 500	25 ... 500	25 ... 300	25 ... 150
Hysteresis material constant	η_B	$10^{-6}/\text{mT}$	< 1,0	< 1,0	< 1,4	< 1,4
Curie temperature	T_C	°C	> 210	> 230	> 210	> 220
Mean value of α_F at 25 ... 55 °C		$10^{-6}/\text{K}$	4	4	3	4
Density (typical values)		kg/m ³	4850	4920	4800	4800
Relative core losses (typical values)	P_V					
25 kHz, 200 mT, 100 °C		kW/m ³	57	45	80	180
100 kHz, 200 mT, 100 °C		kW/m ³	375	300	540	1400
300 kHz, 100 mT, 100 °C		kW/m ³	390	340	500	—
500 kHz, 50 mT, 100 °C		kW/m ³	215	205	—	—
1 MHz, 50 mT, 100 °C	kW/m ³	—	—	—	—	
Resistivity	ρ	Ωm	10	8	12	2
Core shapes			RM, TT, P, PM, ETD, EFD, E, ER, ELP, U Toroid	RM, PM, ETD, EFD, ER, E, ELP, Tor- oid	E, EFD	RM, P
Other material properties (graphs) see page			81	87	78	67

1) Improved, new data

Material properties (continued)

Preferred application			Injection-molded parts	Film	
Material			Ferrite Polymer Composite (FPC)		
Base material			C302	C350	C351
	Symbol	Unit			
Initial permeability $f = 1 \text{ MHz}$	μ_i		$17 \pm 20 \%$	$9 \pm 20 \%$	$9 \pm 20 \%$
Flux density (near saturation) $H = 25 \text{ kA/m}$ $f = 10 \text{ kHz}$	$B_S (25^\circ\text{C})$	mT	330	255	255
Remanent induction $H = 25 \text{ kA/m}$ $f = 10 \text{ kHz}$	$B_r (25^\circ\text{C})$	mT	15	9	9
Coercive field strength $H = 25 \text{ kA/m}$ $f = 10 \text{ kHz}$	$H_C (25^\circ\text{C})$	A/m	770	600	600
Relative loss factor $f = 1 \text{ MHz}$ $f = 100 \text{ MHz}$ $f = 1 \text{ GHz}$	$\tan\delta/\mu_i$		$< 0,0004$ $< 0,03$	$< 0,005$ $< 0,400$	$< 0,005$ $< 0,400$
Hysteresis material constant	η_B	$10^{-3}/\text{mT}$	$< 0,25$	< 2	< 2
Temperature coefficient	$\alpha = \Delta\mu/\mu\Delta T$	1/K	$< 0,0002$	$< 5 \cdot 10^{-5}$	$< 5 \cdot 10^{-5}$
Density		kg/m^3	3500	2930	2930
Resistivity $f = 1 \text{ kHz}$ $f = 10 \text{ kHz}$ $f = 10 \text{ MHz}$	ρ	Ωm	21 13	500 100	500 100
Relative permittivity $f = 1 \text{ kHz}$ $f = 10 \text{ kHz}$ $f = 10 \text{ MHz}$	ϵ_r		280 100	700 21	700 21
Maximum operating temperature	T_{max}	$^\circ\text{C}$	180	120	200
Dielectric strength		kV/mm	—	1	0,8
Tensile strength ¹⁾	σ_Z	N/mm ²	—	1,5	2,5
Tearing resistance ¹⁾		%	—	25	25
Compressibility ¹⁾	κ	N/mm ²	—	70	70
Other material properties (graphs) see page			49	—	—

 1) $T = 23^\circ\text{C}$ and 50 % relative humidity

3 Measuring conditions

The following measuring conditions, which correspond largely to IEC 60401, apply for the material properties given in the table:

Properties (valid only for ring cores of sizes R 10 to R 36)			Measuring conditions			
			Frequency	Field strength (material-dependent)	Max. flux density	Temperature
			kHz	kA/m	mT	°C
Initial permeability	μ_i		≤ 10		$\leq 0,25$	25
Flux density near to saturation	B	mT	≤ 10	$\geq 1,2$		25; 100
Coercive field strength	H_c	A/m kA/m	≤ 10	$\geq 1,2$	near saturation	25; 100
Relative loss factor	$\tan \delta/\mu_i$		–		$\leq 0,25$	25
Hysteresis material constant	η_B	mT ⁻¹	10 ($\mu_i \geq 500$) 100 ($\mu_i < 500$)		B_1 B_2 1,5 3,0 0,3 1,2	25
Curie temperature	T_c	°C	≤ 10		$\leq 0,25$	
Relative temperature coefficient	α_F	10 ⁻⁶ /K	≤ 10		$\leq 0,25$	5 ... 25 25 ... 55
Density		kg/m ³				25
Disaccommodation factor	DF	10 ⁻⁶	≤ 10		$\leq 0,25$	25; 60 ¹⁾
Resistivity	ρ	Ωm	DC			25

The following properties are given only for materials for power applications:

Power loss	P_V	kW/m ³	25		200	100
			100		200	
			300		100	
			500		50	
			1000		50	

1) Higher temperature than specified by IEC (40 °C)

4 Specific material data

DC magnetic bias

$$H_{-} = \frac{I_{-} \cdot N}{l_{e}}$$

H_{-} = DC field strength [A/m]
 I_{-} = Direct current [A]
 N = Number of turns
 l_{e} = Effective magnetic path length [m]

The curves of $\mu_{\text{rev}} = f(H_{-})$ allow an approximate calculation of the variation in reversible permeability (μ_{rev}) and A_L value caused by magnetic bias. These curves are of particular interest for cores for transformers and chokes, since magnetic bias should be avoided if possible with inductors requiring high stability (filter inductors etc.). In the case of geometrically similar cores (i.e. in particular the same A_{min}/A_e ratio) the effective permeability of the core in question in conjunction with the given curves suffices to determine the reversible permeability to a close approximation.

Relative loss factor versus frequency

(measured with ring cores, measuring flux density $\hat{B} \leq 0,25$ mT)

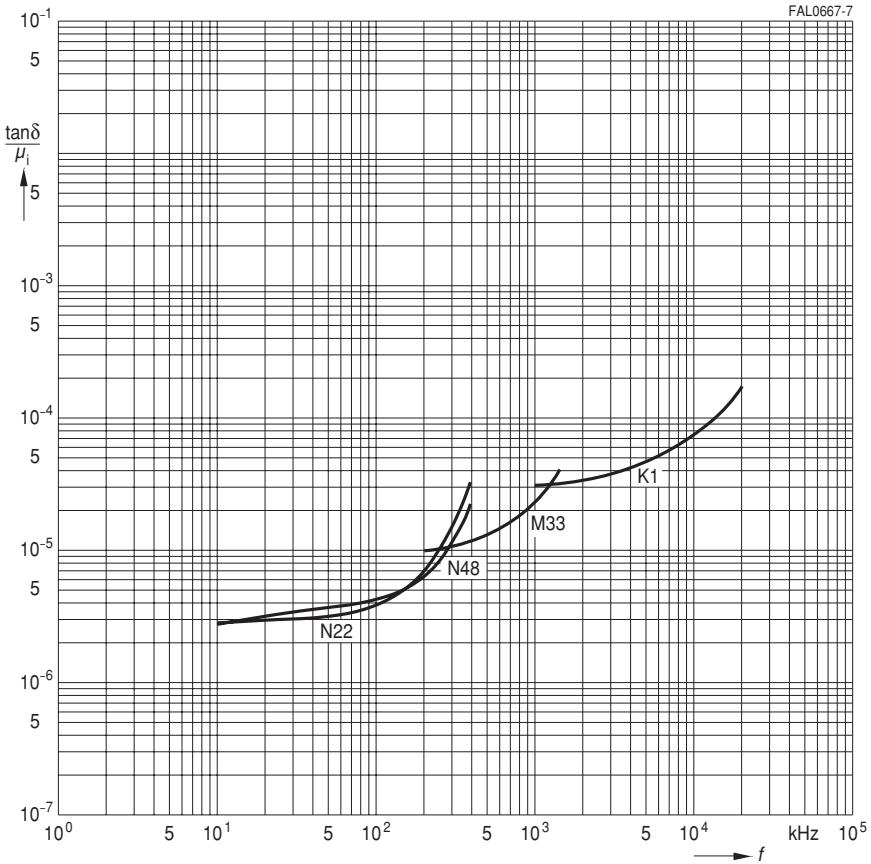

Relative inductance component versus frequency
 (measured with ring cores, measuring flux density $\hat{B} \leq 0,25$ mT)

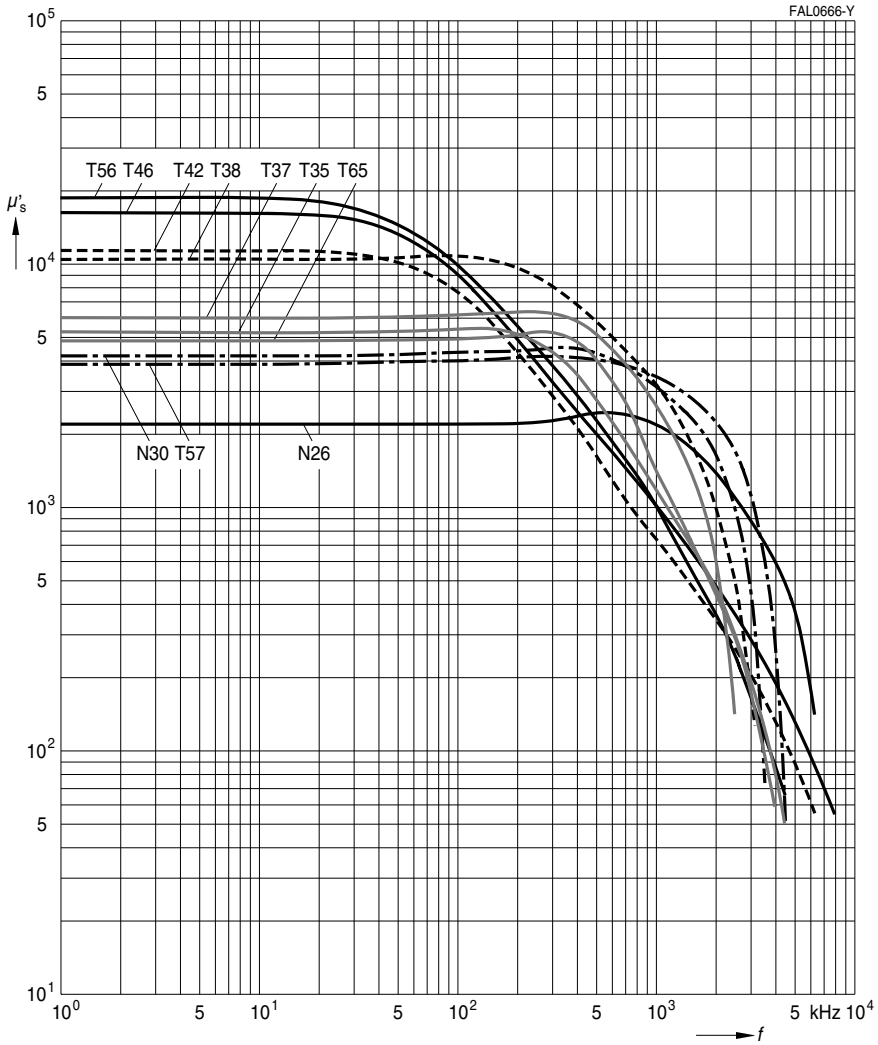

Performance factor versus frequency

(measured with ring cores R29, $T = 100\text{ }^{\circ}\text{C}$, $P_V = 300\text{ kW/m}^3$)

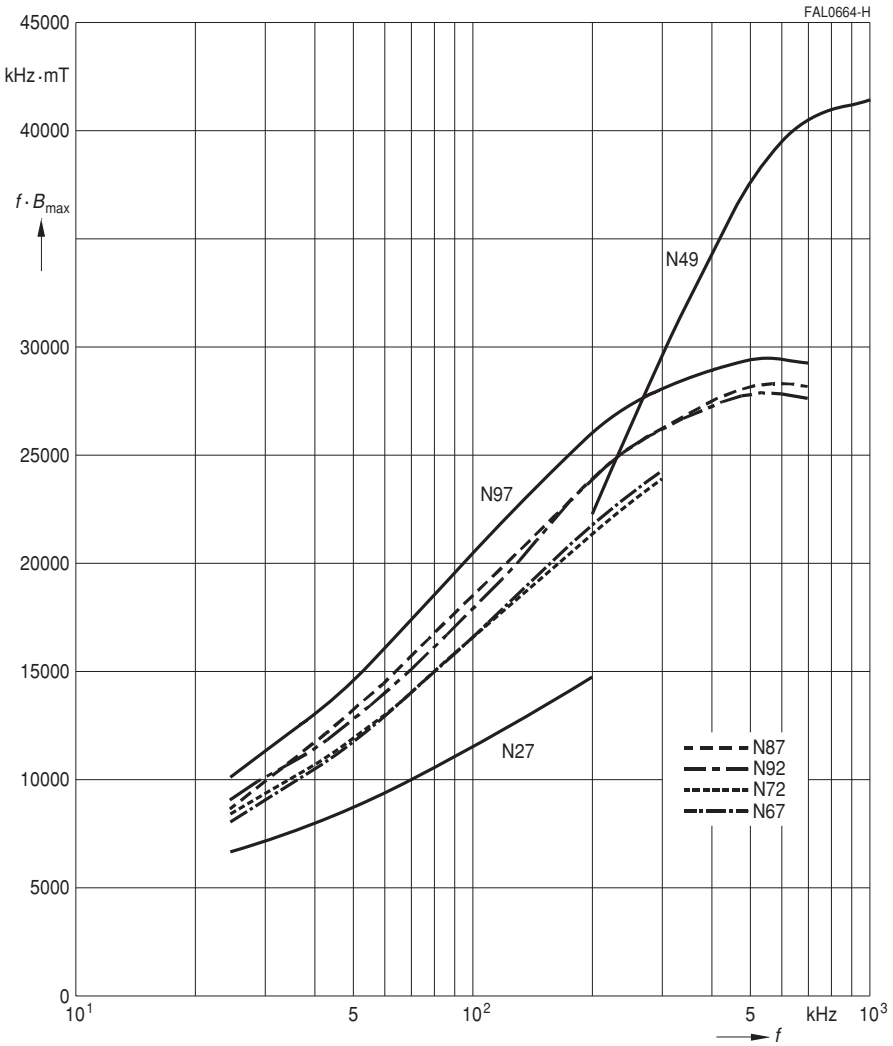

For definition of performance factor see page 116.

Standardized hysteresis material constant versus temperature

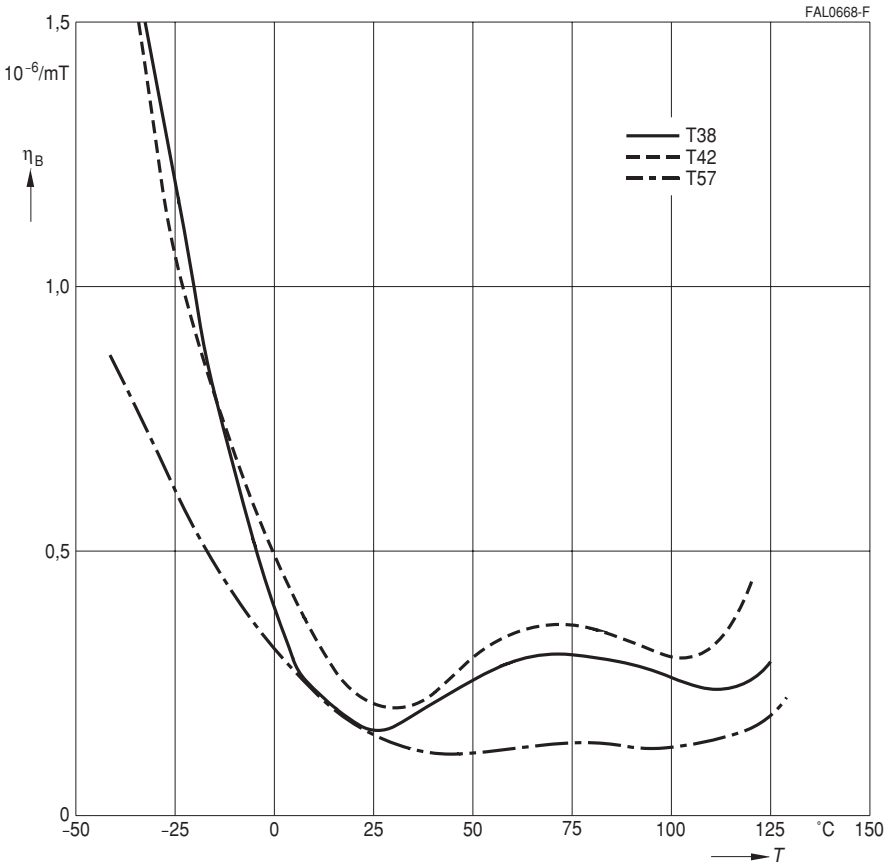

SIFERRIT Materials

Normalized Impedance

K 1

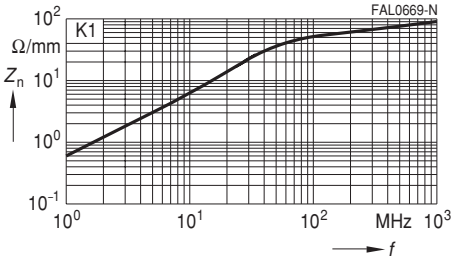

K 6

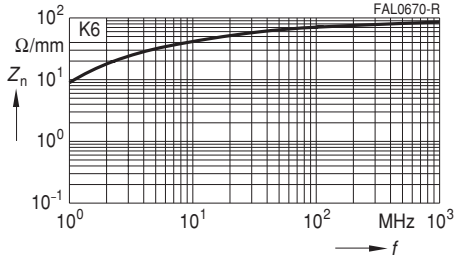

K 7

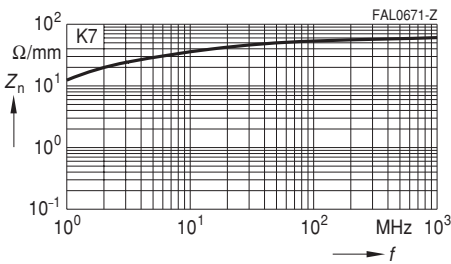

K 8

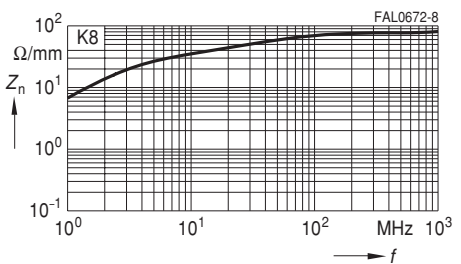

K 10

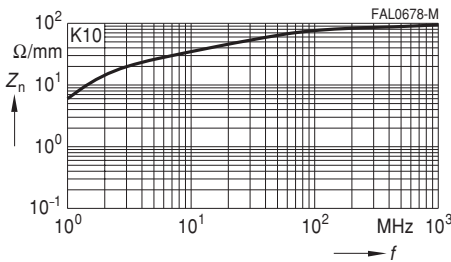

M 13

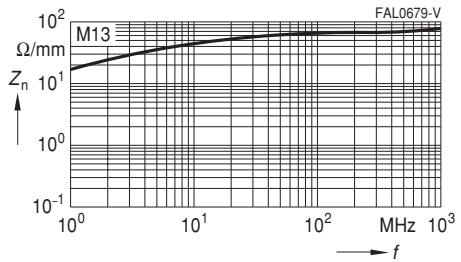

For explanation of Z_n see page 133.

Complex permeability versus frequency
(measured on R20/10 toroids, $\hat{B} \leq 0,25$ mT)

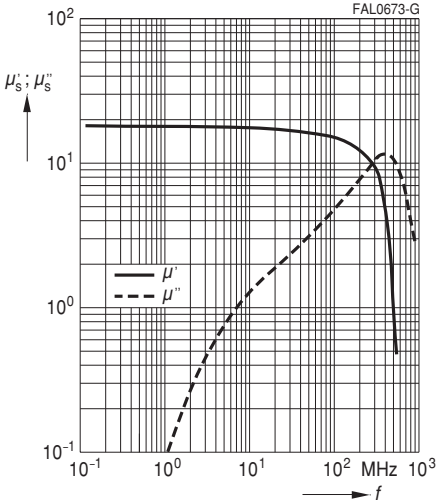

Relative loss factor versus frequency
(measured on R20/10 toroids, $\hat{B} \leq 0,25$ mT)

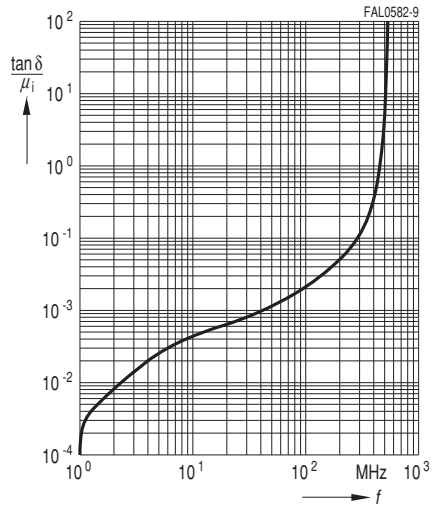

Complex permeability
versus frequency
(measured on R10 toroids, $\hat{B} \leq 0,25$ mT)

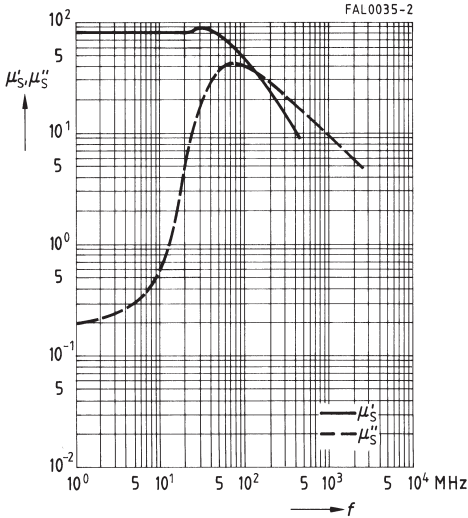

Initial permeability μ_i and relative loss factor
 $\tan \delta / \mu_i$ versus temperature
(measured on R10 toroids, $\hat{B} \leq 0,25$ mT)

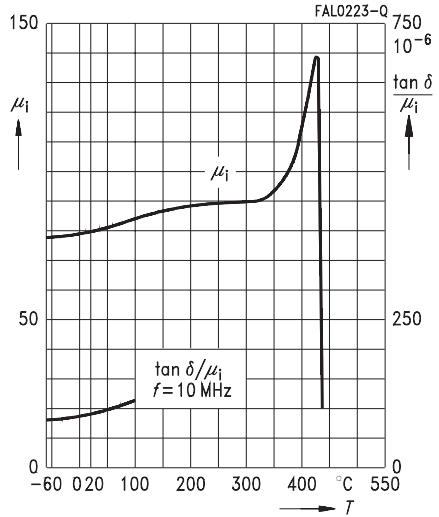

Permeability factor versus temperature
(measured on P and RM cores,
 $\hat{B} \leq 0,25$ mT), $\mu_i \approx 80$

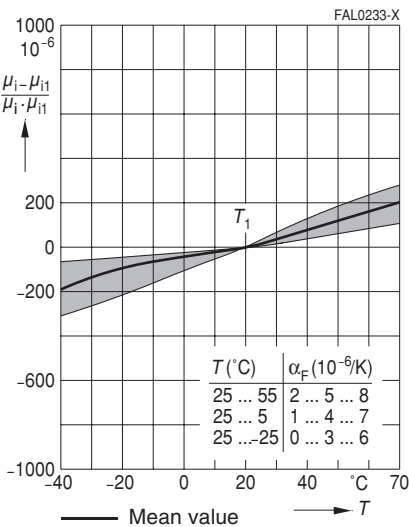

Dynamic magnetization curves
(typical values)
($f = 10 \text{ kHz}$, $T = 25 \text{ }^\circ\text{C}$)

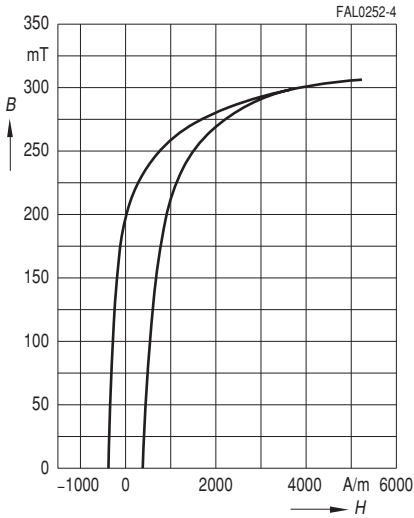

Dynamic magnetization curves
(typical values)
($f = 10 \text{ kHz}$, $T = 100 \text{ }^\circ\text{C}$)

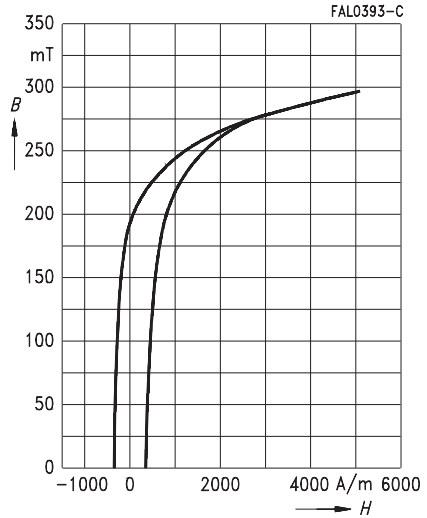

Complex permeability
versus frequency
(measured on R17 toroids, $\hat{B} \leq 0,25$ mT)

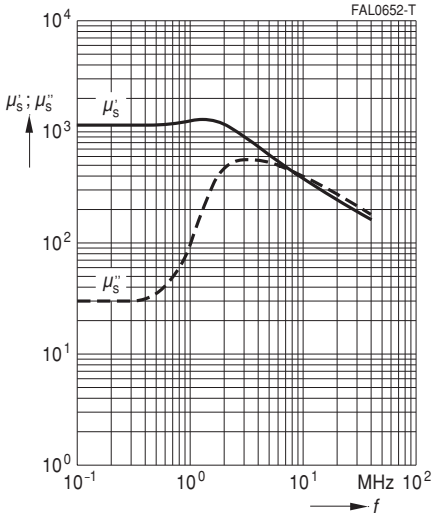

Initial permeability μ_i and relative loss factor
 $\tan \delta/\mu_i$ versus temperature
(measured on R17 toroids, $\hat{B} \leq 0,25$ mT)

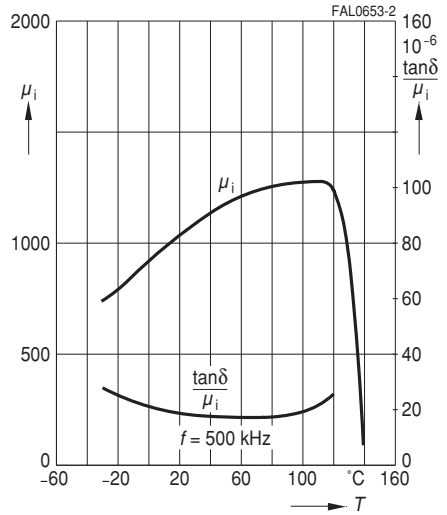

Dynamic magnetization curves
(typical values)
($f = 10$ kHz, $T = 25$ °C)

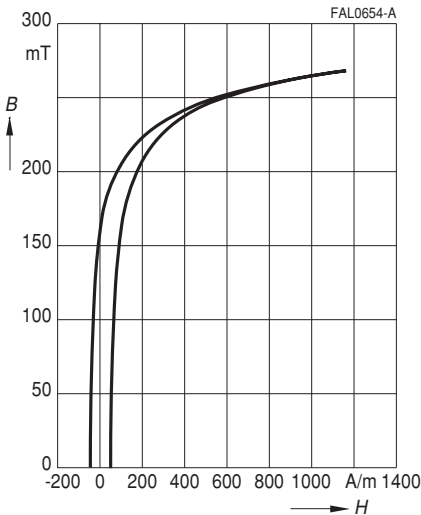

Dynamic magnetization curves
(typical values)
($f = 10$ kHz, $T = 100$ °C)

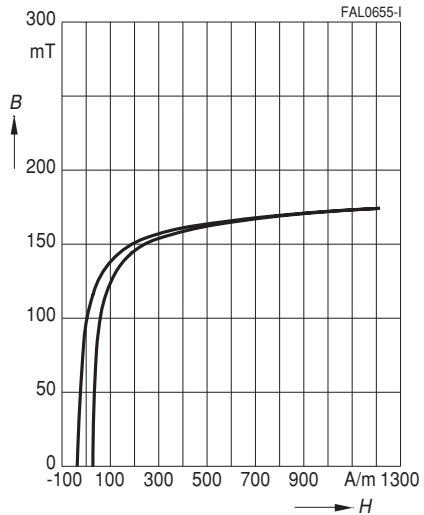

Complex permeability
versus frequency
(measured on R17 toroids, $\hat{B} \leq 0,25$ mT)

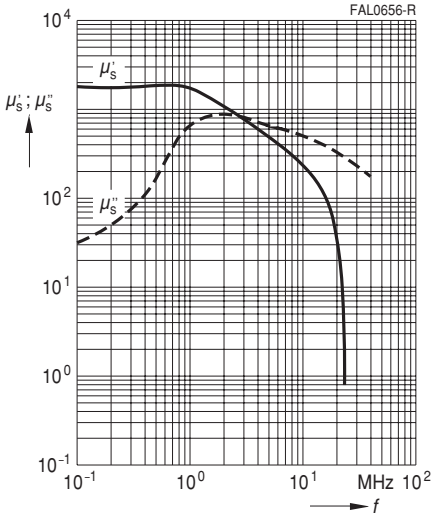

Initial permeability μ_i and relative loss factor
 $\tan \delta/\mu_i$ versus temperature
(measured on R17 toroids, $\hat{B} \leq 0,25$ mT)

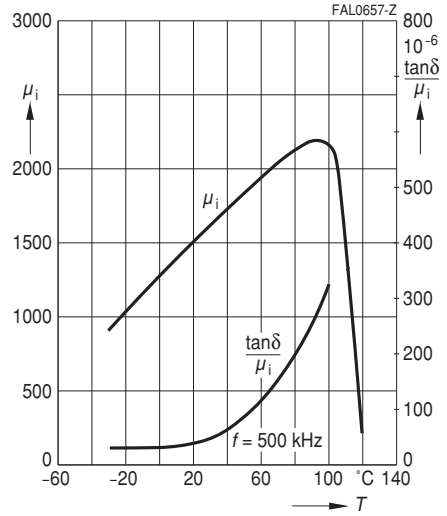

Dynamic magnetization curves
(typical values)
($f = 10$ kHz, $T = 25$ °C)

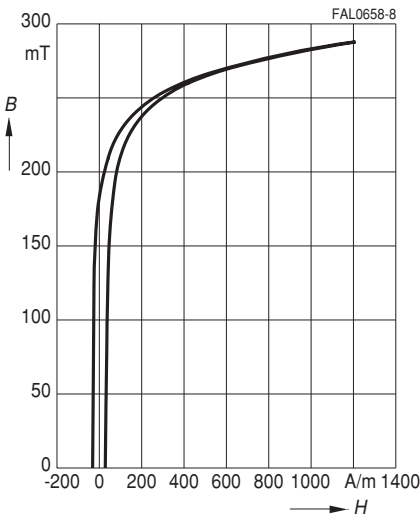

Dynamic magnetization curves
(typical values)
($f = 10$ kHz, $T = 100$ °C)

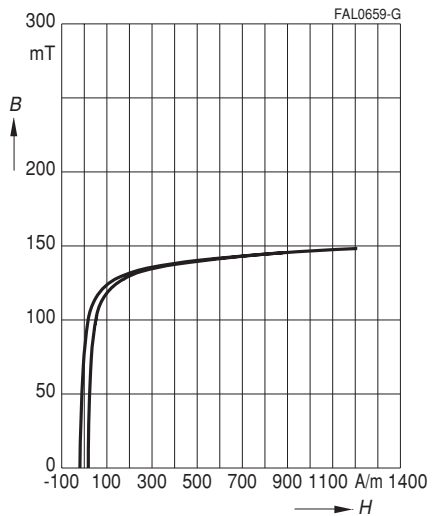

Complex permeability
versus frequency
(measured on R17 toroids, $\hat{B} \leq 0,25$ mT)

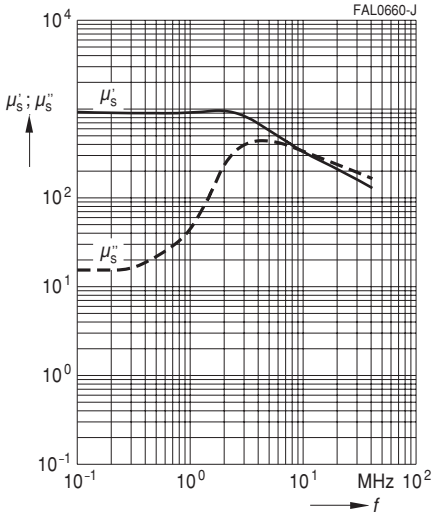

Initial permeability μ_i and relative loss factor
 $\tan \delta/\mu_i$ versus temperature
(measured on R17 toroids, $\hat{B} \leq 0,25$ mT)

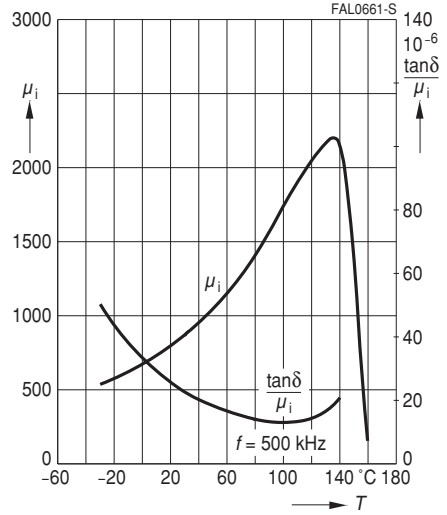

Dynamic magnetization curves
(typical values)
($f = 10$ kHz, $T = 25$ °C)

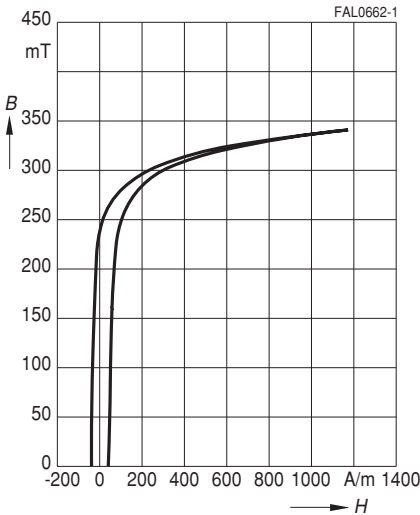

Dynamic magnetization curves
(typical values)
($f = 10$ kHz, $T = 100$ °C)

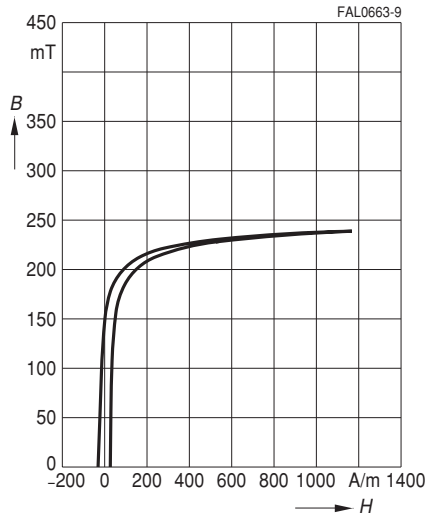

Complex permeability
versus frequency
(measured on R10 toroids, $\hat{B} \leq 0,25$ mT)

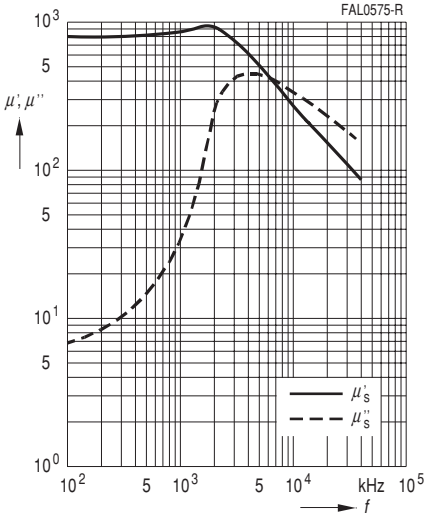

Initial permeability μ_i and relative loss factor
 $\tan \delta / \mu_i$ versus temperature
(measured on R10 toroids, $\hat{B} \leq 0,25$ mT)

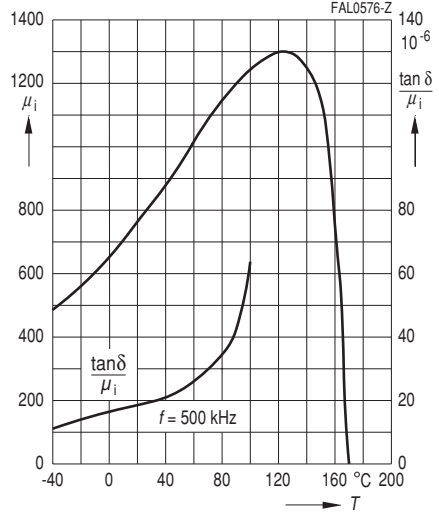

Dynamic magnetization curves
(typical values)
($f = 10$ kHz, $T = 25$ °C)

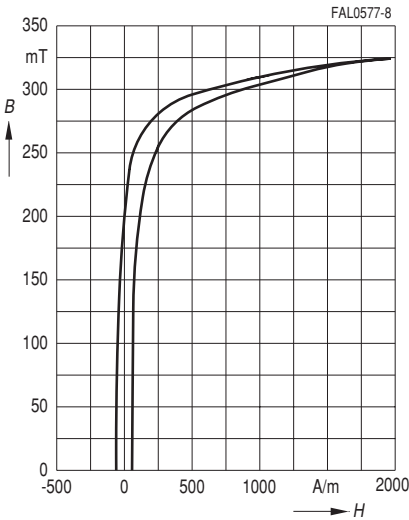

Dynamic magnetization curves
(typical values)
($f = 10$ kHz, $T = 100$ °C)

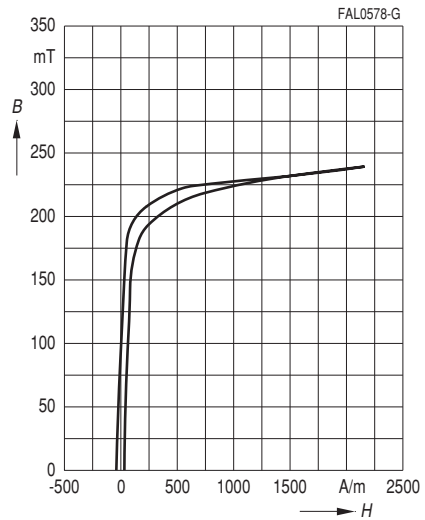

Complex permeability
versus frequency
(measured on R10 toroids, $\hat{B} \leq 0,25$ mT)

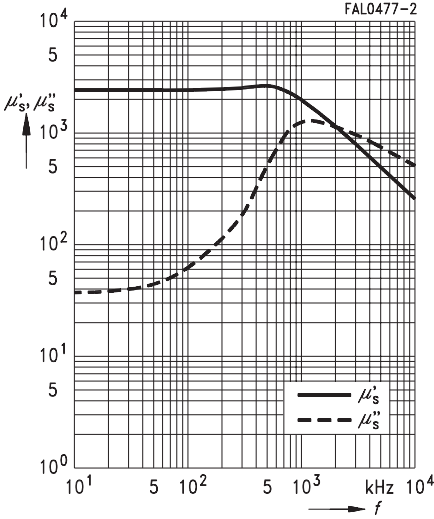

Initial permeability μ_i and relative loss factor
 $\tan \delta / \mu_i$ versus temperature
(measured on R25 toroids, $\hat{B} \leq 0,25$ mT)

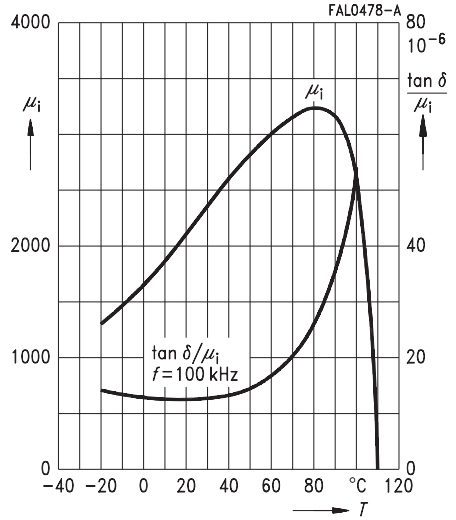

Dynamic magnetization curves
(typical values)
($f = 10$ kHz, $T = 25$ °C)

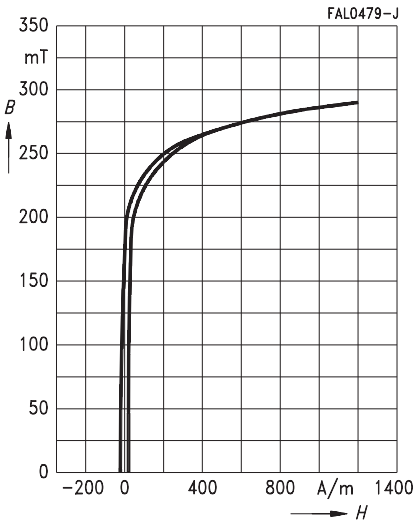

Dynamic magnetization curves
(typical values)
($f = 10$ kHz, $T = 100$ °C)

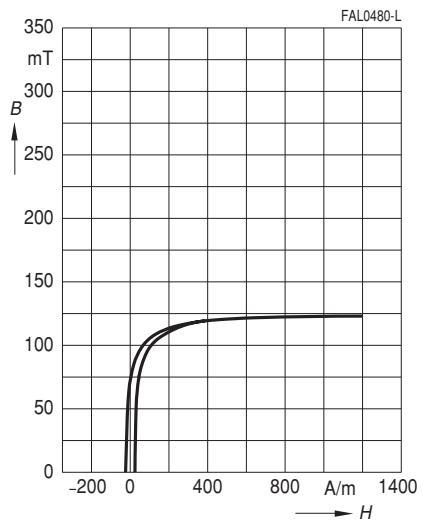

Complex permeability
versus frequency
(measured on R10 toroids, $\hat{B} \leq 0,25$ mT)

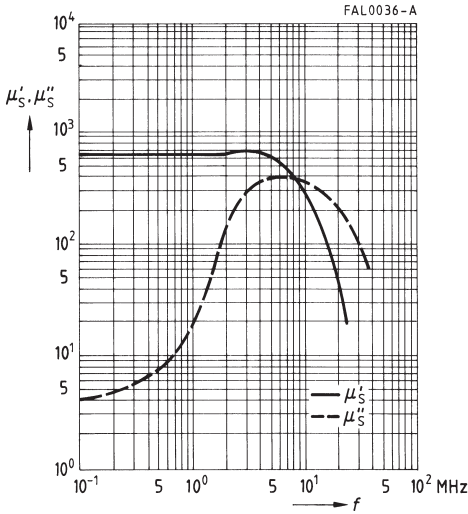

Initial permeability μ_i and relative loss factor
 $\tan \delta / \mu_i$ versus temperature
(measured on R10 toroids, $\hat{B} \leq 0,25$ mT)

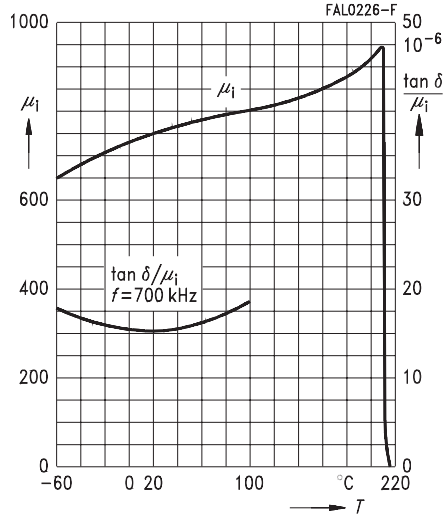

Permeability factor versus temperature
(measured on P and RM cores,
 $\hat{B} \leq 0,25$ mT), $\mu_i \approx 750$

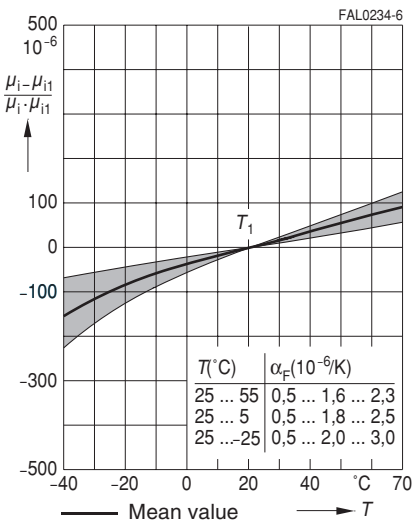

DC magnetic bias of P and RM cores
(typical values)
($\hat{B} \leq 0,25$ mT, $f = 10$ kHz, $T = 25$ $^{\circ}\text{C}$)

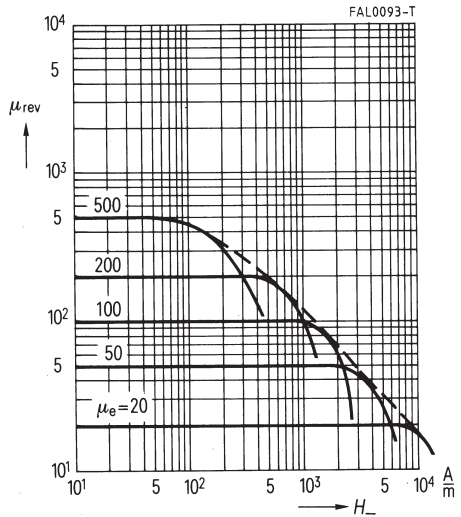

Dynamic magnetization curves
(typical values)
($f = 10 \text{ kHz}$, $T = 25 \text{ °C}$)

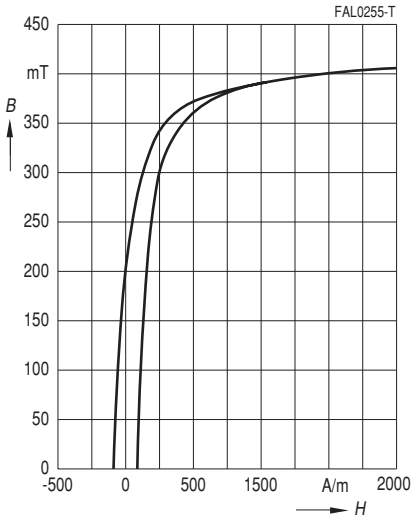

Dynamic magnetization curves
(typical values)
($f = 10 \text{ kHz}$, $T = 100 \text{ °C}$)

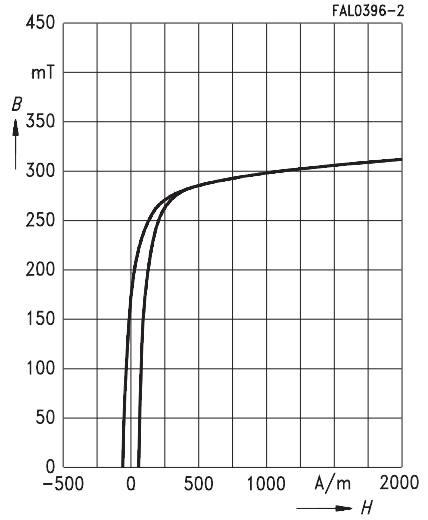

Complex permeability
versus frequency
(measured on R10 toroids, $\hat{B} \leq 0,25$ mT)

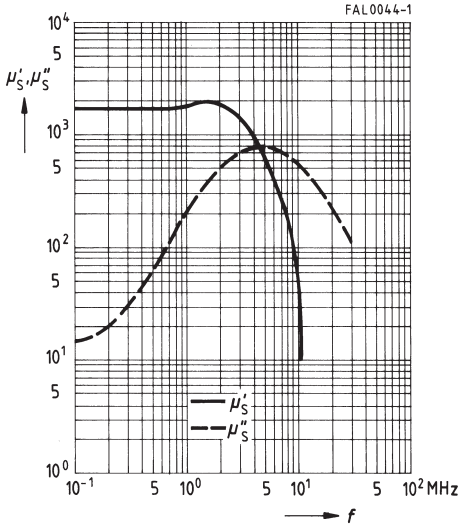

Initial permeability μ_i and relative loss factor
 $\tan \delta/\mu_i$ versus temperature
(measured on R10 toroids, $\hat{B} \leq 0,25$ mT)

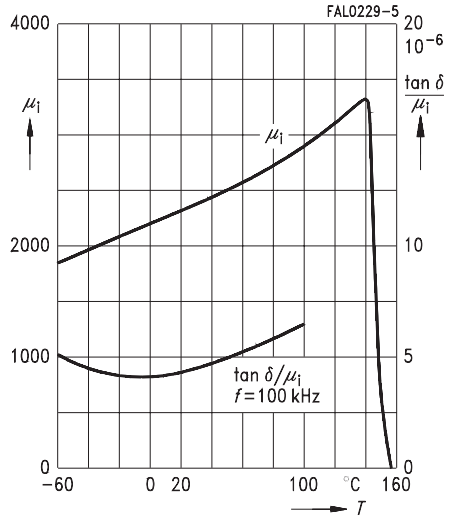

Dynamic magnetization curves
(typical values)
($f = 10$ kHz, $T = 25$ °C)

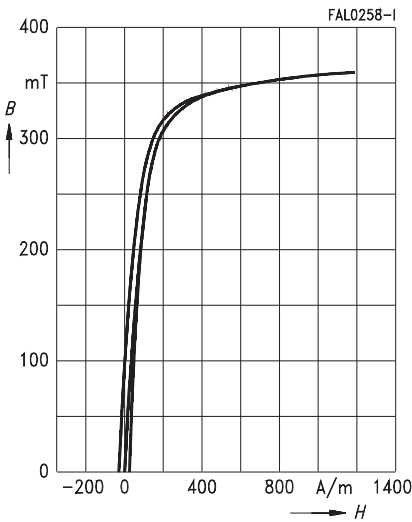

Dynamic magnetization curves
(typical values)
($f = 10$ kHz, $T = 100$ °C)

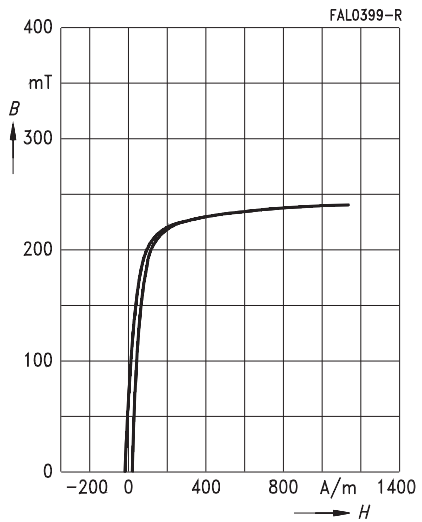

Complex permeability
versus frequency
(measured on R10 toroids, $\hat{B} \leq 0,25$ mT)

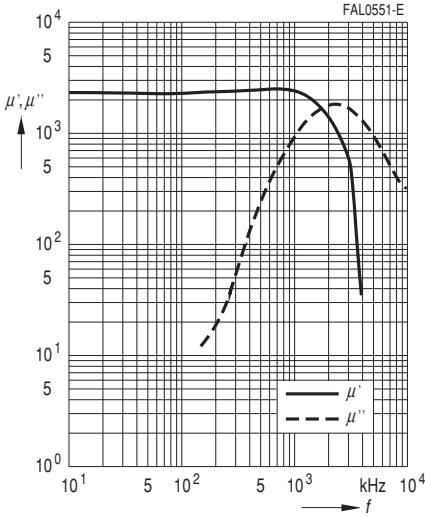

Initial permeability μ_i and relative loss factor
 $\tan \delta / \mu_i$ versus temperature
(measured on R10 toroids, $\hat{B} \leq 0,25$ mT)

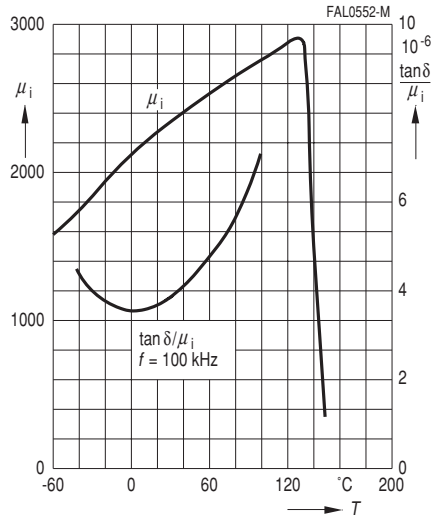

Permeability factor
versus temperature
(measured on R10 toroids, $\hat{B} \leq 0,25$ mT)

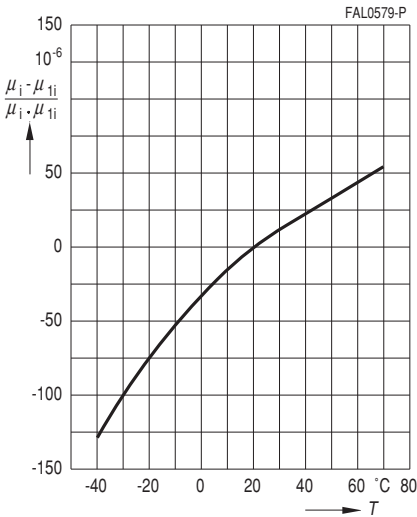

Relative loss factor
versus frequency
(measured on R14 toroids, $\hat{B} \leq 0,25$ mT)

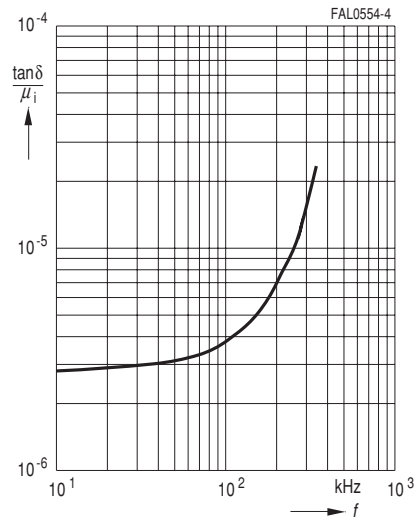

SIFERRIT Materials

N 26

Dynamic magnetization curves
(typical values)
($f = 10 \text{ kHz}$, $T = 25 \text{ }^\circ\text{C}$)

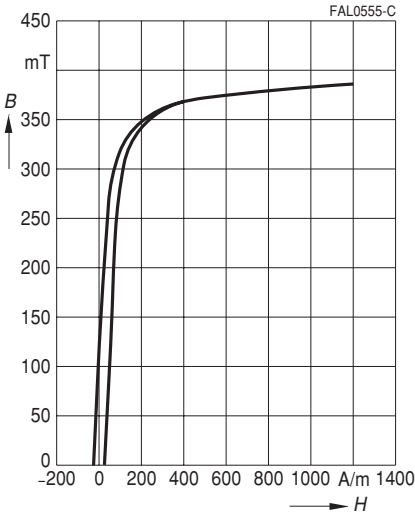

Dynamic magnetization curves
(typical values)
($f = 10 \text{ kHz}$, $T = 100 \text{ }^\circ\text{C}$)

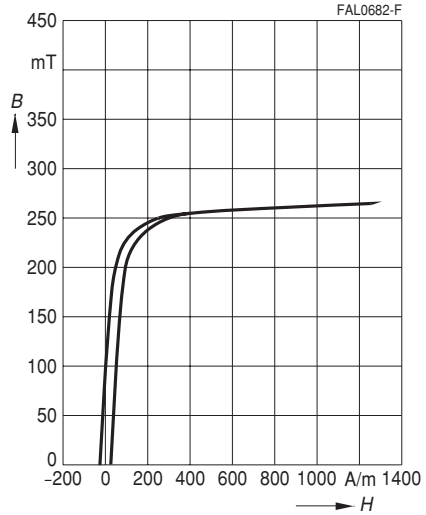

DC magnetic bias of P and RM cores
(typical values)
($\bar{B} \leq 0,25 \text{ mT}$, $f = 10 \text{ kHz}$, $T = 25 \text{ }^\circ\text{C}$)

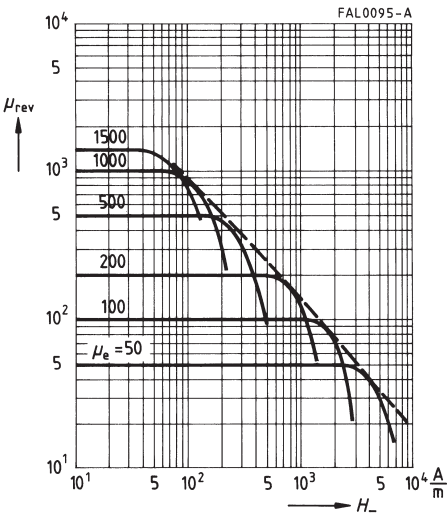

Complex permeability
versus frequency
(measured on R10 toroids, $\hat{B} \leq 0,25$ mT)

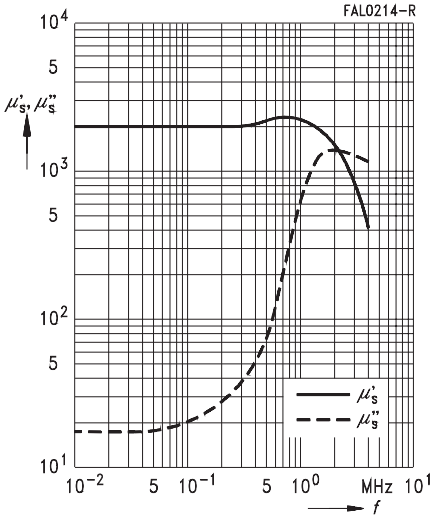

Initial permeability μ_i
versus temperature
(measured on R10 toroids, $\hat{B} \leq 0,25$ mT)

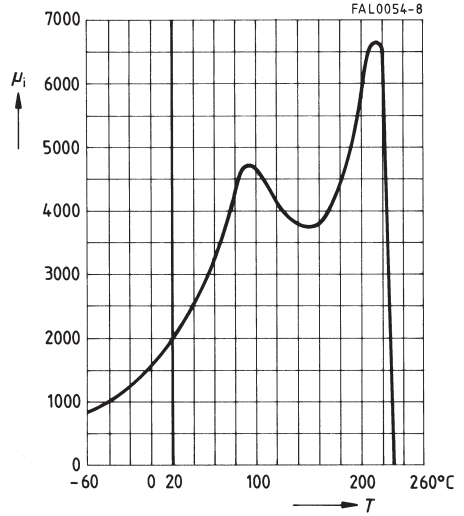

Amplitude permeability versus AC field
flux density
(measured on ungapped E cores)

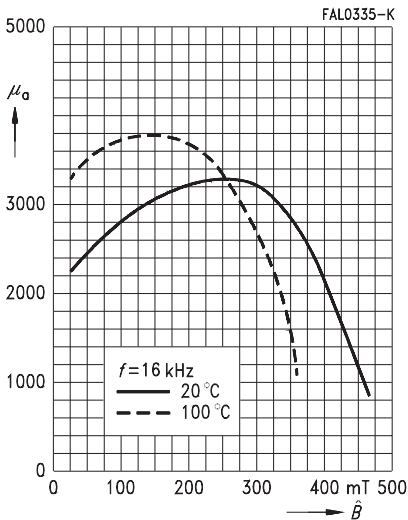

Dynamic magnetization curves
(typical values)
($f = 10 \text{ kHz}$, $T = 25 \text{ }^\circ\text{C}$)

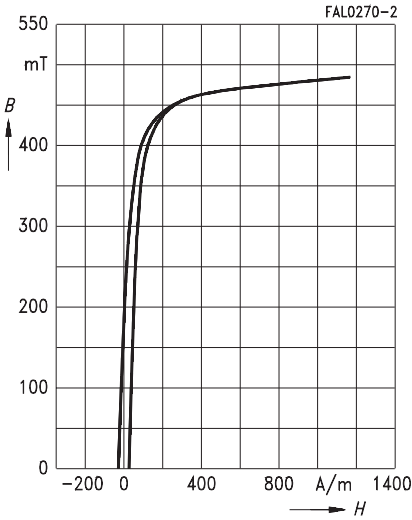

Dynamic magnetization curves
(typical values)
($f = 10 \text{ kHz}$, $T = 100 \text{ }^\circ\text{C}$)

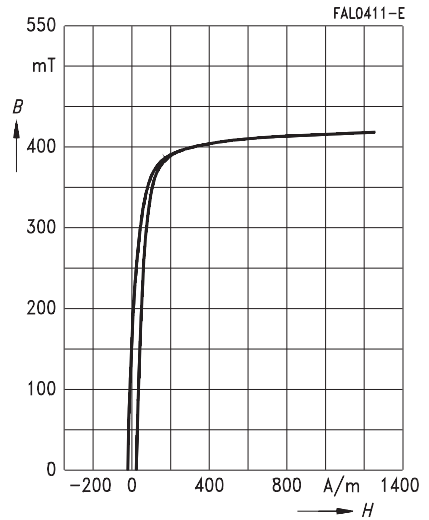

DC magnetic bias
measured on ETD cores
($\hat{B} \leq 0,25 \text{ mT}$, $f = 10 \text{ kHz}$, $T = 25 \text{ }^\circ\text{C}$)

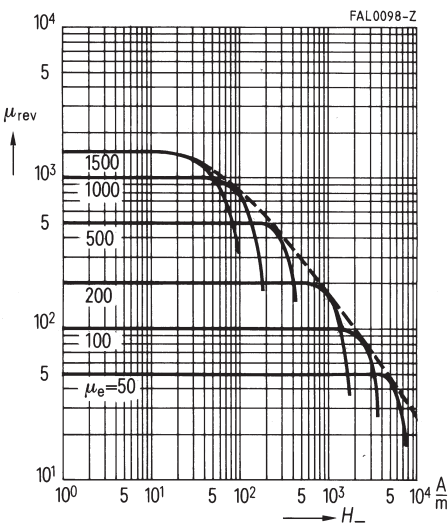

Relative core losses versus AC field flux density
(measured on R16 toroids)

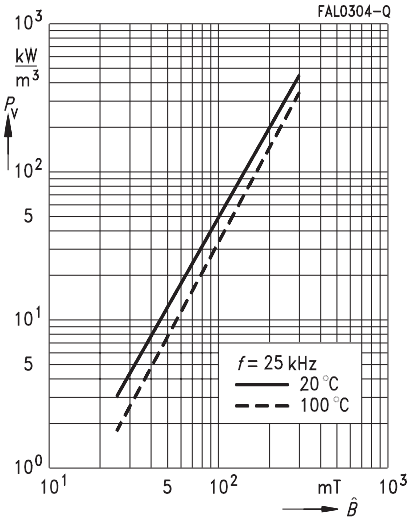

Relative core losses versus temperature
(measured on R16 toroids)

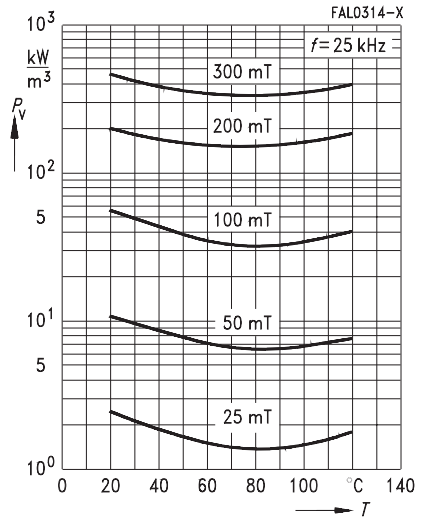

Relative core losses versus frequency
(measured on R16 toroids)

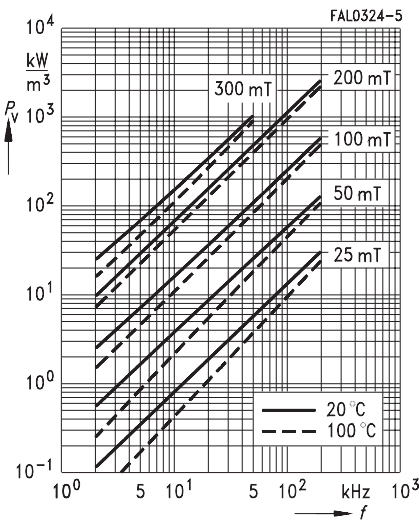

Complex permeability
versus frequency
(measured on R10 toroids, $\hat{B} \leq 0,25$ mT)

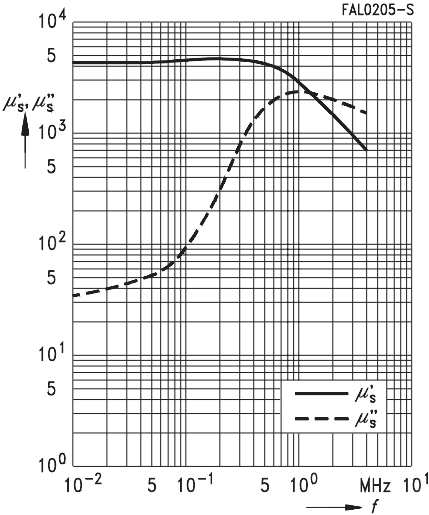

Initial permeability μ_i
versus temperature
(measured on R10 toroids, $\hat{B} \leq 0,25$ mT)

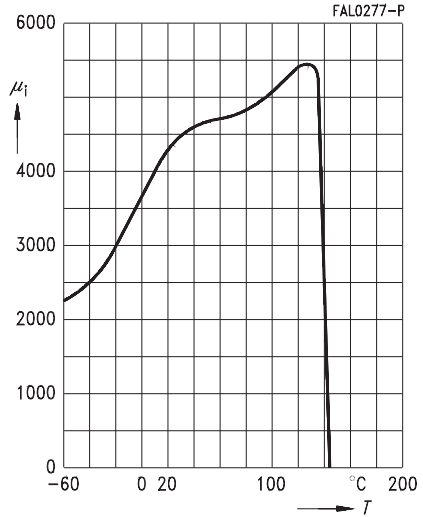

Variation of initial permeability
with temperature
(measured on R10 toroids, $\hat{B} \leq 0,25$ mT)

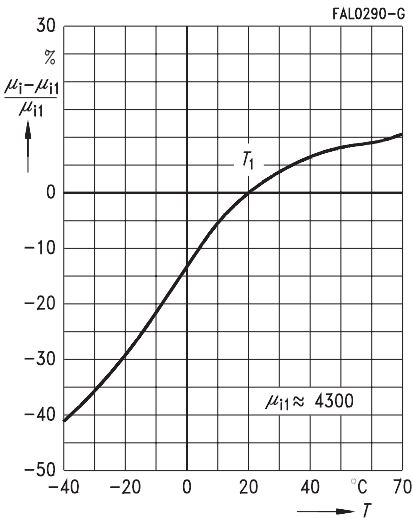

Relative loss factor
versus frequency
(measured on R20 toroids, $\hat{B} \leq 0,25$ mT)

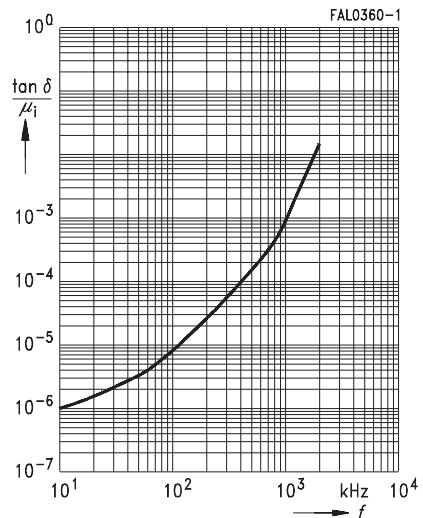

Dynamic magnetization curves
(typical values)
($f = 10 \text{ kHz}$, $T = 25 \text{ }^\circ\text{C}$)

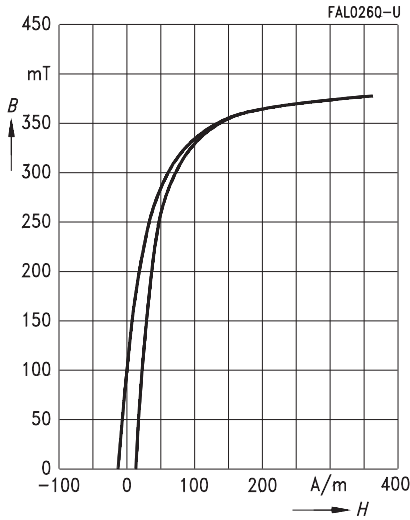

Dynamic magnetization curves
(typical values)
($f = 10 \text{ kHz}$, $T = 100 \text{ }^\circ\text{C}$)

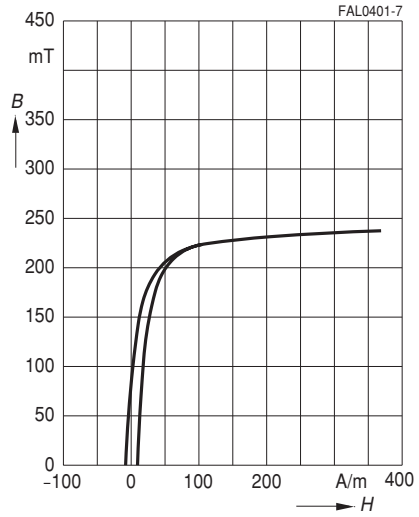

DC magnetic bias of RM cores
(typical values)
($\hat{B} \leq 0,25 \text{ mT}$, $f = 10 \text{ kHz}$, $T = 25 \text{ }^\circ\text{C}$)

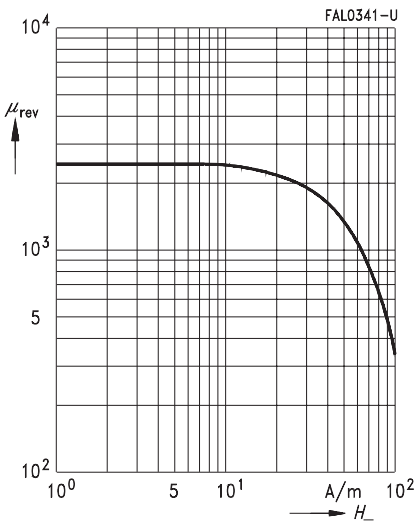

Complex permeability
versus frequency
(measured with R10 ring cores, $\hat{B} \leq 0,25$ mT)

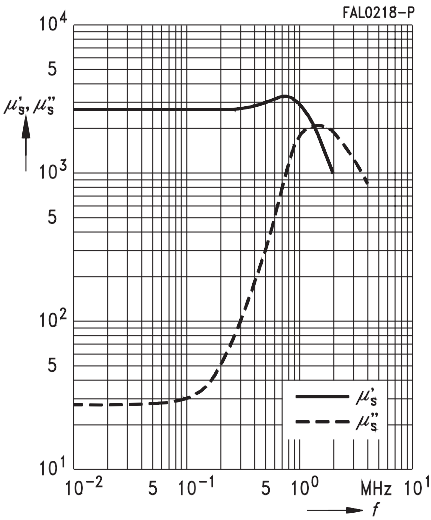

Initial permeability μ_i
versus temperature
(measured with R10 ring cores, $\hat{B} \leq 0,25$ mT)

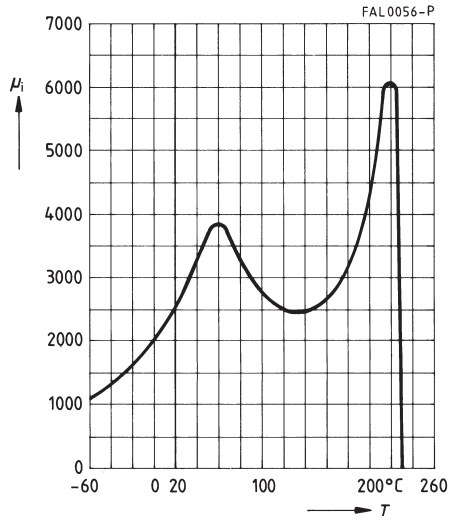

Amplitude permeability
versus AC field flux density
(measured on ungapped E cores)

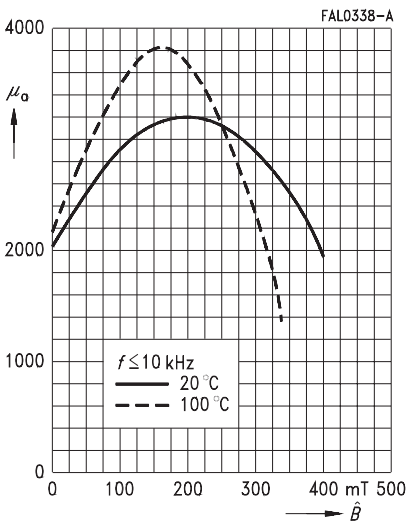

Dynamic magnetization curves
(typical values)
($f = 10 \text{ kHz}$, $T = 25 \text{ }^\circ\text{C}$)

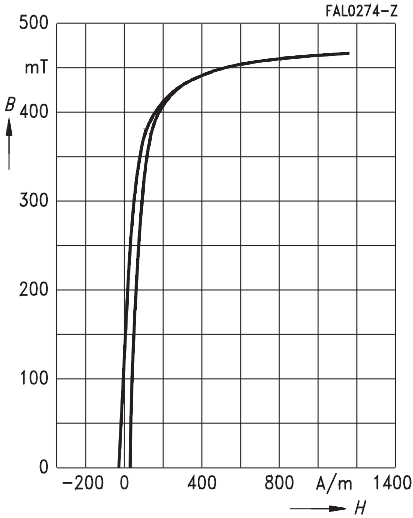

Dynamic magnetization curves
(typical values)
($f = 10 \text{ kHz}$, $T = 100 \text{ }^\circ\text{C}$)

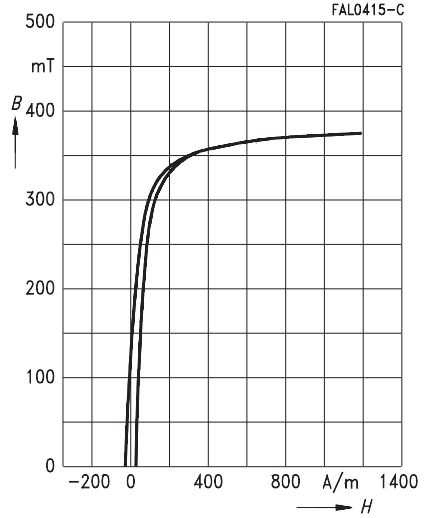

DC magnetic bias
of P and RM cores
($\bar{B} \leq 0,25 \text{ mT}$, $f = 10 \text{ kHz}$, $T = 25 \text{ }^\circ\text{C}$)

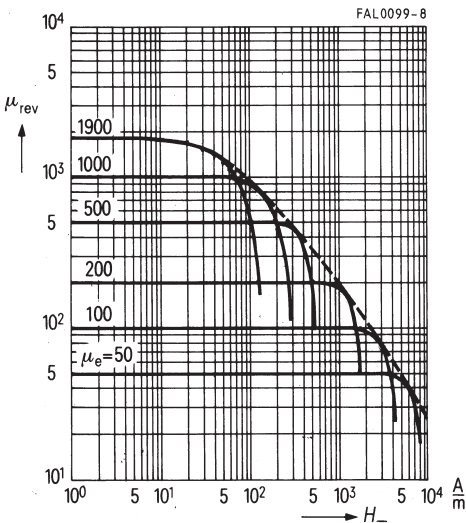

Relative core losses
versus AC field flux density
(measured on R16 toroids)

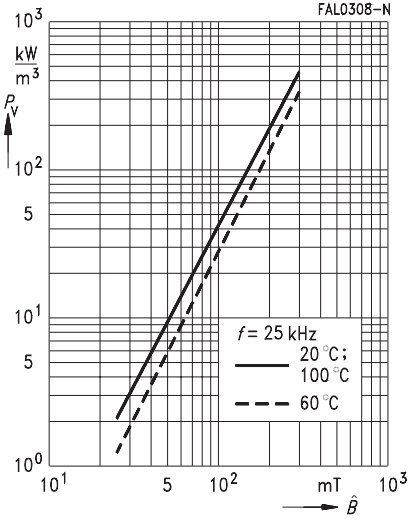

Relative core losses
versus temperature
(measured on R16 toroids)

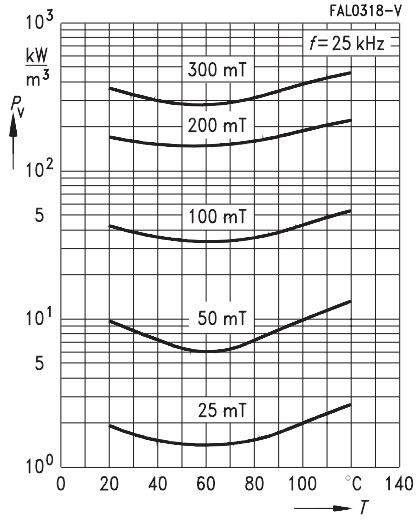

Relative core losses
versus frequency
(measured on R16 toroids)

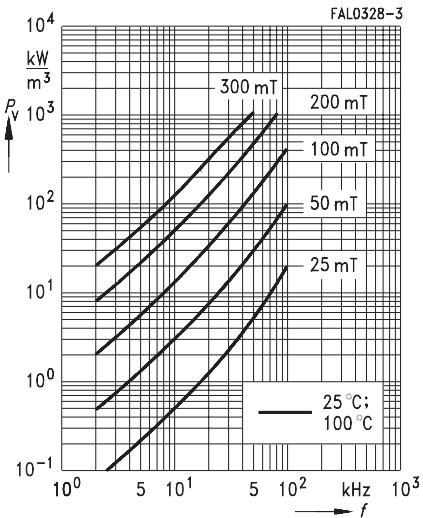

Complex permeability
versus frequency
(measured on R10 toroids, $\hat{B} \leq 0,25$ mT)

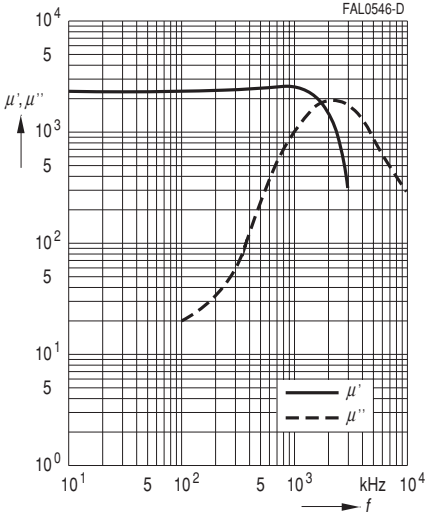

Initial permeability μ_i and relative loss factor
 $\tan \delta/\mu_i$ versus temperature
(measured on R10 toroids, $\hat{B} \leq 0,25$ mT)

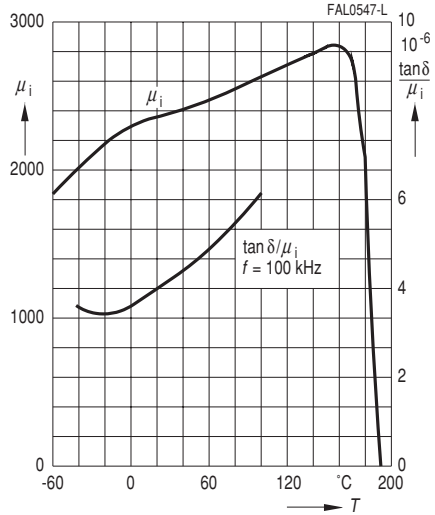

Permeability factor versus temperature
(measured on P and RM cores,
 $\hat{B} \leq 0,25$ mT), $\mu_i \approx 2300$

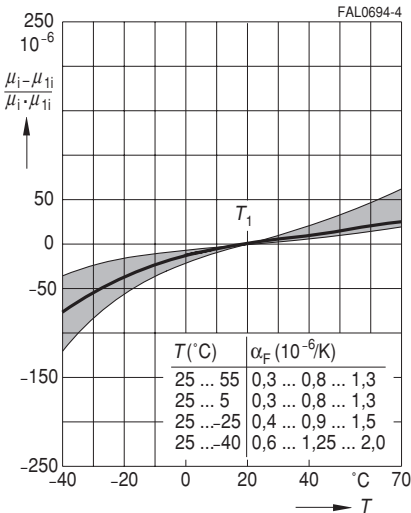

Relative loss factor $\tan \delta/\mu_i$
versus frequency
(measured on R29 toroids)

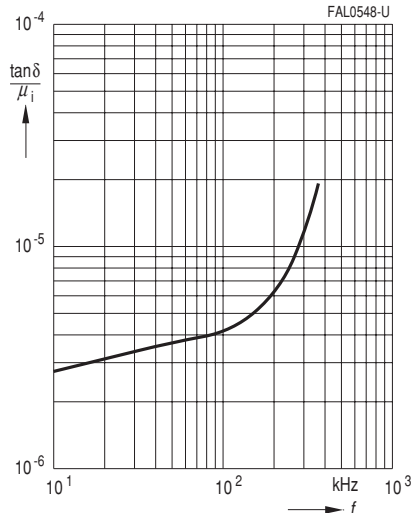

Dynamic magnetization curves
(typical values)
($f = 10 \text{ kHz}$, $T = 25 \text{ }^\circ\text{C}$)

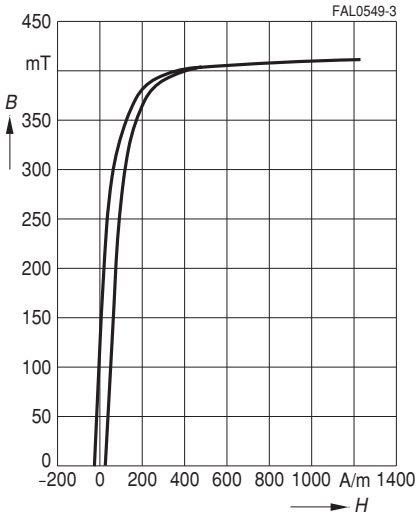

Dynamic magnetization curves
(typical values)
($f = 10 \text{ kHz}$, $T = 100 \text{ }^\circ\text{C}$)

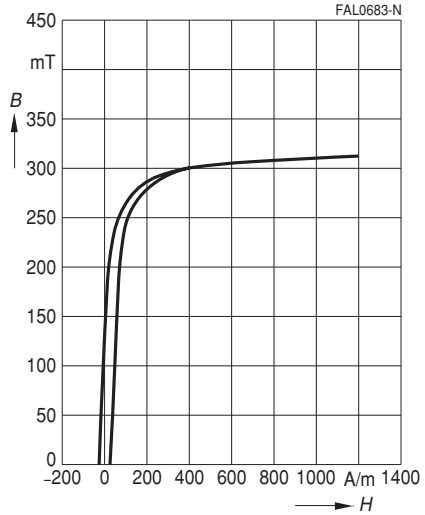

DC magnetic bias
(measured on ETD cores, typical values)
($\bar{B} \leq 0,25 \text{ mT}$, $f = 10 \text{ kHz}$, $T = 25 \text{ }^\circ\text{C}$)

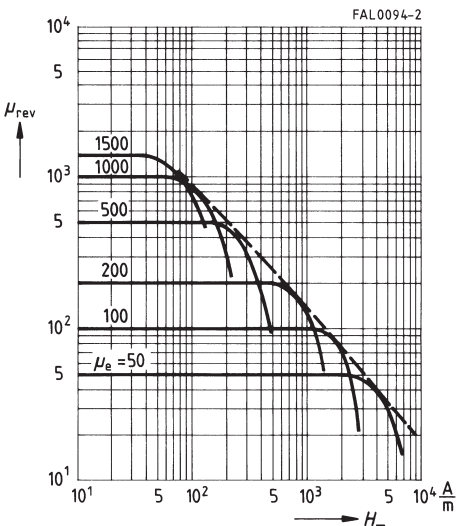

Complex permeability
versus frequency
(measured on R34 toroids, $\hat{B} \leq 0,25$ mT)

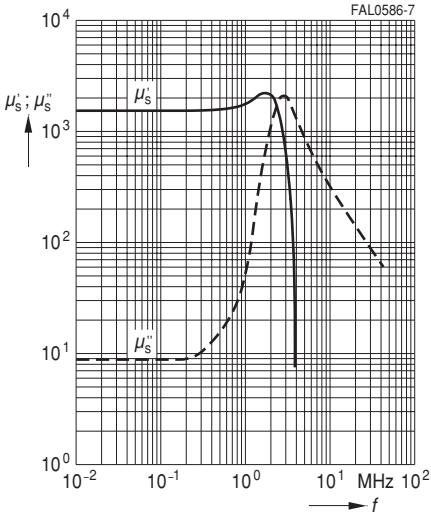

Initial permeability μ_i
versus temperature
(measured on R34 toroids, $\hat{B} \leq 0,25$ mT)

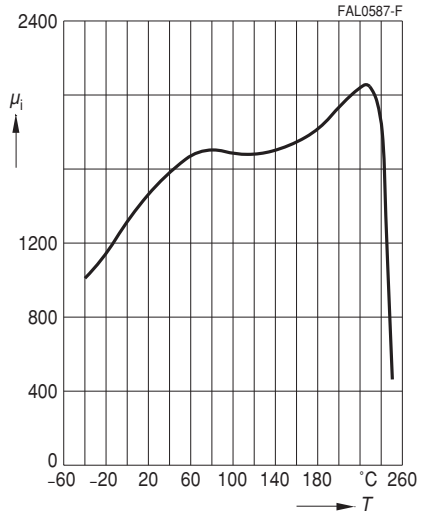

Amplitude permeability
versus AC field flux density
(measured on R34 toroids, $\hat{B} \leq 0,25$ mT)

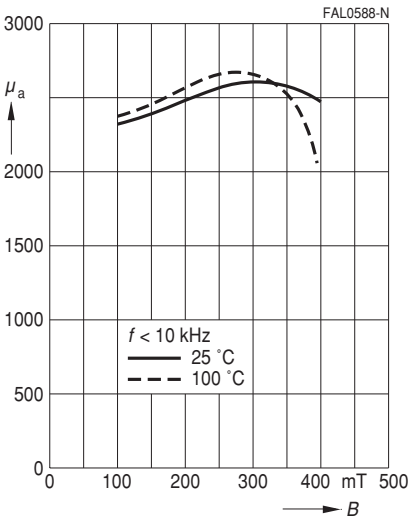

Dynamic magnetization curves
(typical values)
($f = 10 \text{ kHz}$, $T = 25 \text{ }^\circ\text{C}$)

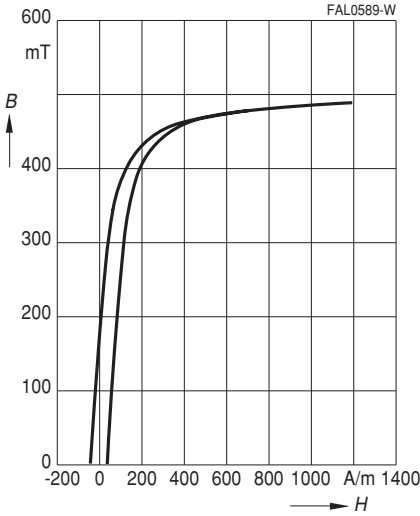

Dynamic magnetization curves
(typical values)
($f = 10 \text{ kHz}$, $T = 100 \text{ }^\circ\text{C}$)

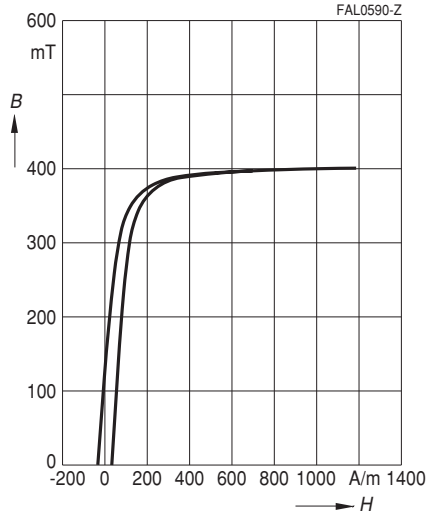

DC magnetic bias
measured on ETD cores
($\bar{B} \leq 0,25 \text{ mT}$, $f = 10 \text{ kHz}$, $T = 25 \text{ }^\circ\text{C}$)

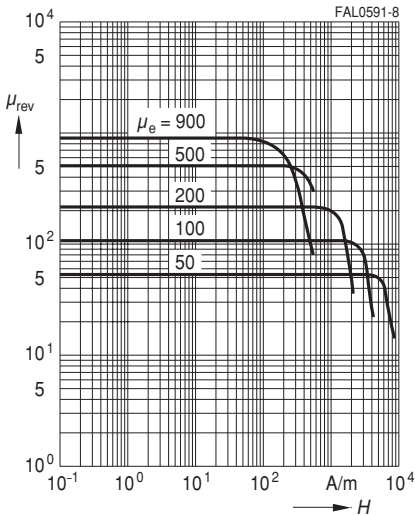

DC magnetic bias
measured on ETD cores
($\bar{B} \leq 0,25 \text{ mT}$, $f = 10 \text{ kHz}$, $T = 100 \text{ }^\circ\text{C}$)

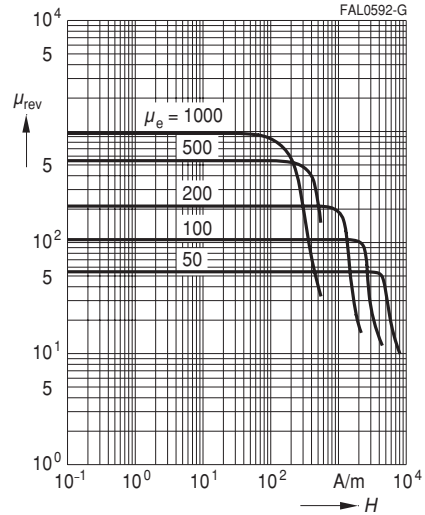

Relative core losses
versus AC field flux density
(measured on R34 toroids)

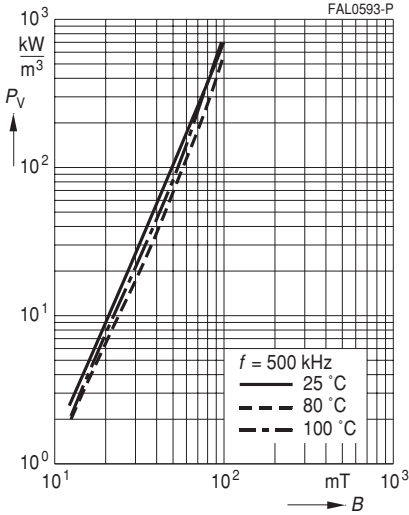

Relative core losses
versus temperature
(measured on R34 toroids)

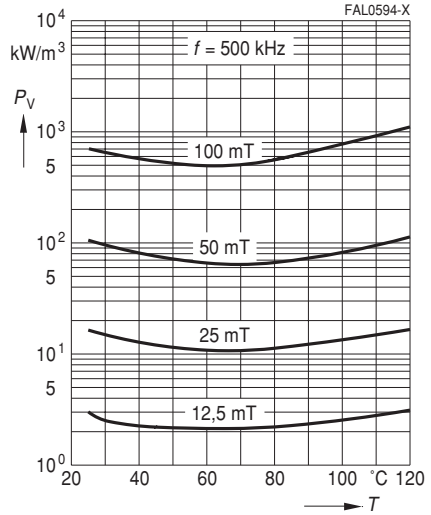

Relative core losses
versus frequency
(measured on R34 toroids)

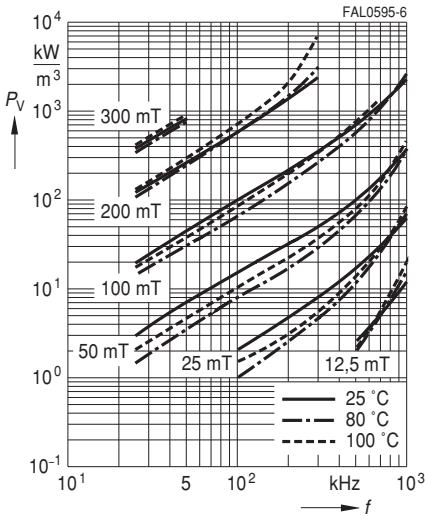

SIFERRIT Materials

N 67

Not for new design

Complex permeability

versus frequency

(measured on R10 toroids, $\hat{B} \leq 0,25$ mT)

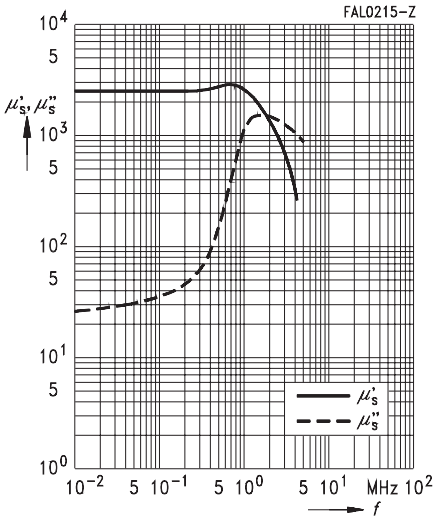

Initial permeability μ_i

versus temperature

(measured on R10 toroids, $\hat{B} \leq 0,25$ mT)

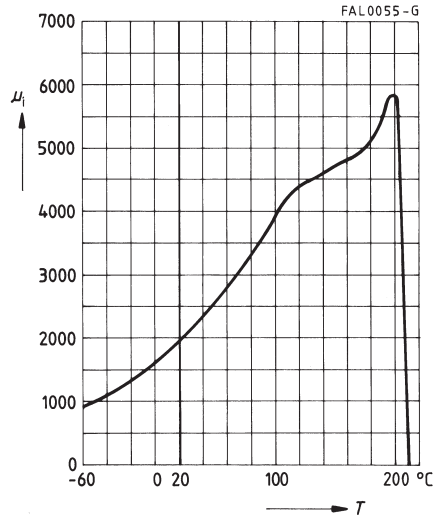

Amplitude permeability versus AC field

flux density

(measured on ungapped E cores)

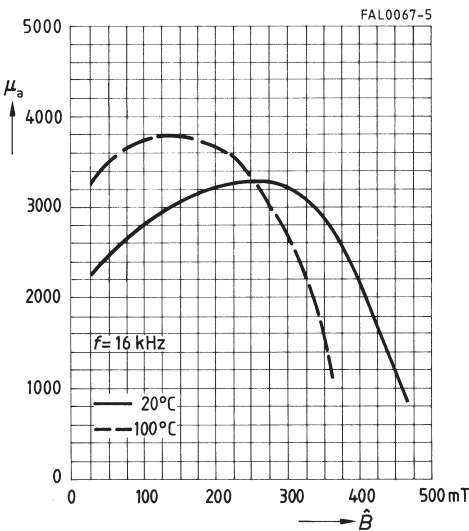

Not for new design

Dynamic magnetization curves

(typical values)

($f = 10 \text{ kHz}$, $T = 25 \text{ }^\circ\text{C}$)

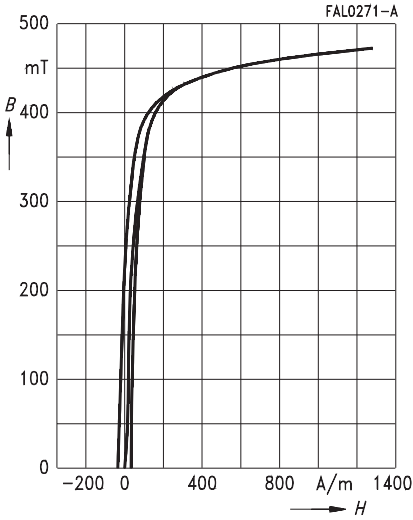

Dynamic magnetization curves

(typical values)

($f = 10 \text{ kHz}$, $T = 100 \text{ }^\circ\text{C}$)

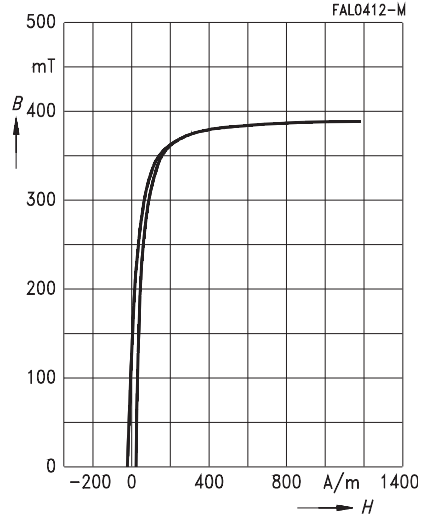

DC magnetic bias

of P, RM, PM and E cores

($\hat{B} \leq 0,25 \text{ mT}$, $f = 10 \text{ kHz}$, $T = 25 \text{ }^\circ\text{C}$)

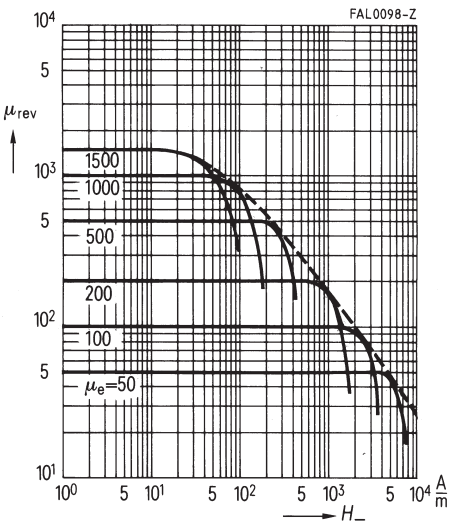

Not for new design

Relative core losses versus AC field flux density
(measured on R16 toroids)

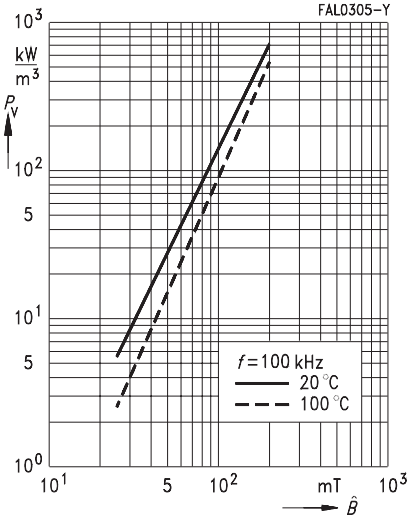

Relative core losses versus temperature
(measured on R16 toroids)

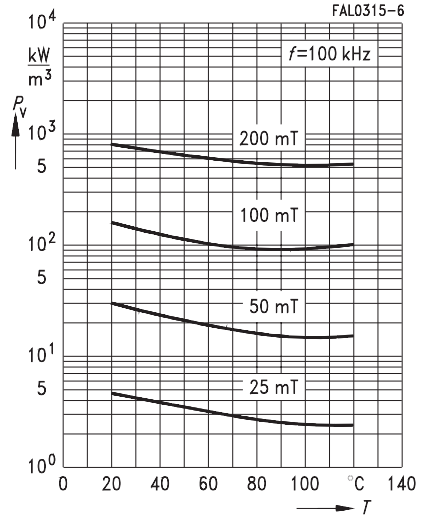

Relative core losses versus frequency
(measured on R16 toroids)

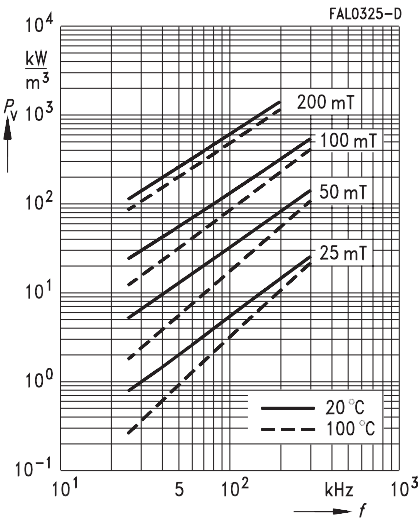

Complex permeability
versus frequency
(measured on R29 toroids, $\hat{B} \leq 0,25$ mT)

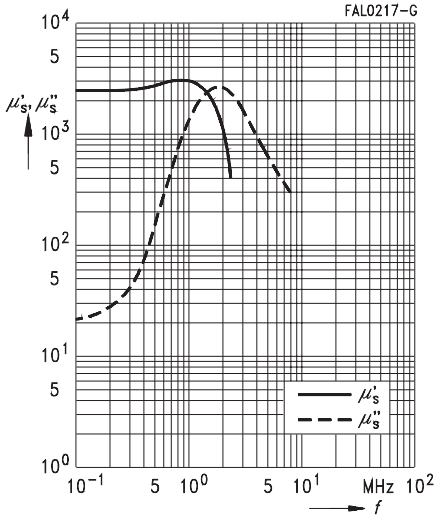

Initial permeability μ_i
versus temperature
(measured on R29 toroids, $\hat{B} \leq 0,25$ mT)

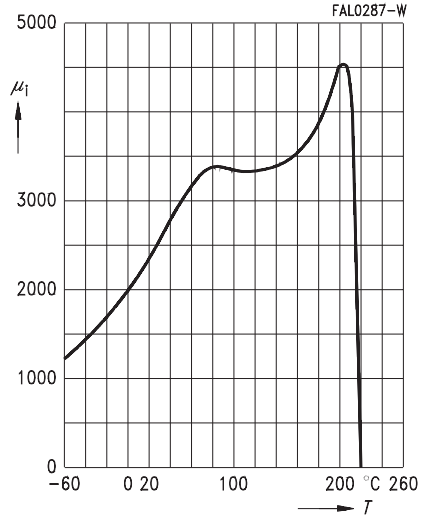

Amplitude permeability versus AC field
flux density
(measured on ungapped U cores)

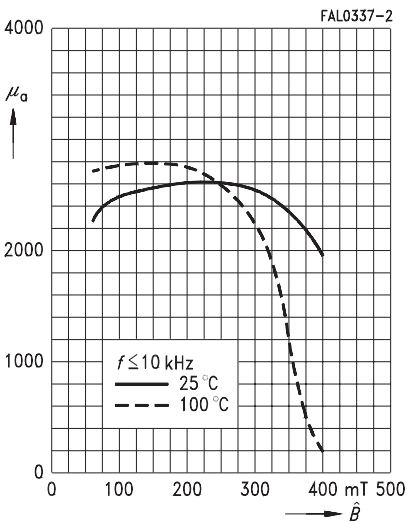

Dynamic magnetization curves
(typical values)
($f = 10 \text{ kHz}$, $T = 25 \text{ }^\circ\text{C}$)

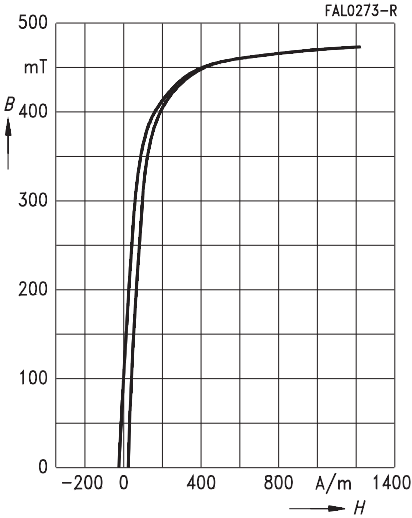

Dynamic magnetization curves
(typical values)
($f = 10 \text{ kHz}$, $T = 100 \text{ }^\circ\text{C}$)

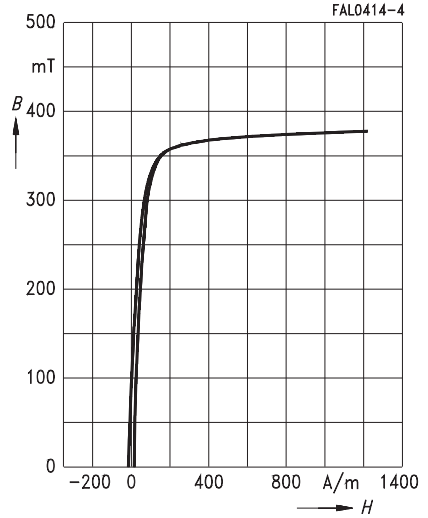

DC magnetic bias of E cores
($\hat{B} \leq 0,25 \text{ mT}$, $f = 10 \text{ kHz}$, $T = 25 \text{ }^\circ\text{C}$)

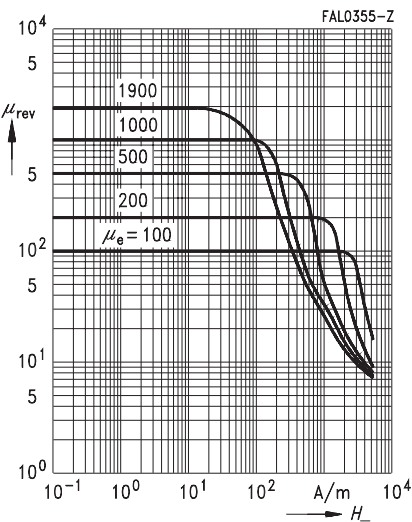

DC magnetic bias of E cores
($\hat{B} \leq 0,25 \text{ mT}$, $f = 10 \text{ kHz}$, $T = 100 \text{ }^\circ\text{C}$)

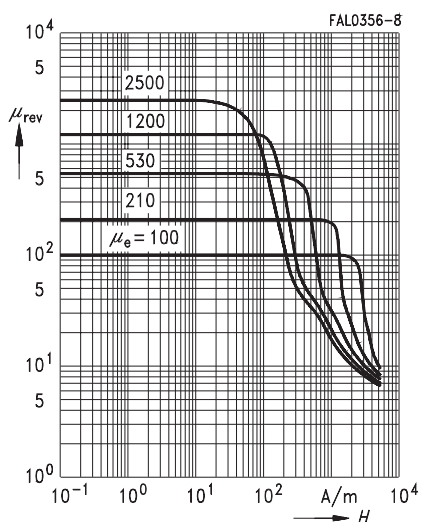

Relative core losses versus AC field flux density
(measured on R29 toroids)

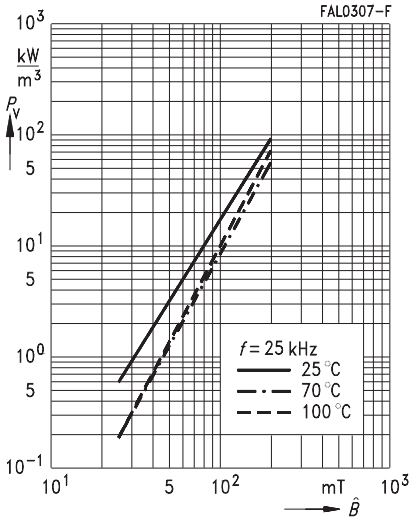

Relative core losses versus temperature
(measured on R29 toroids)

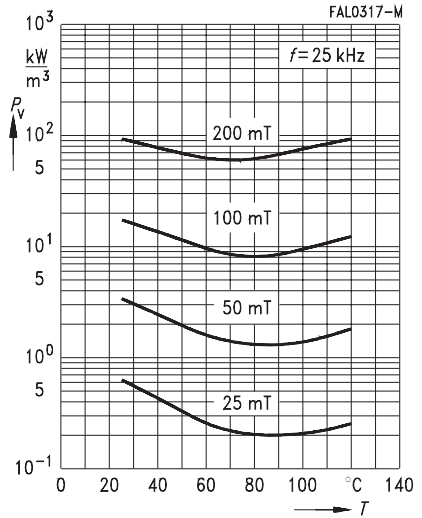

Relative core losses versus frequency
(measured on R29 toroids)

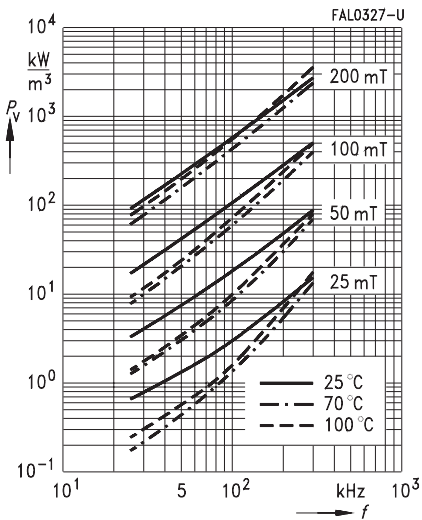

Complex permeability
versus frequency
(measured on R34 toroids, $\hat{B} \leq 0,25$ mT)

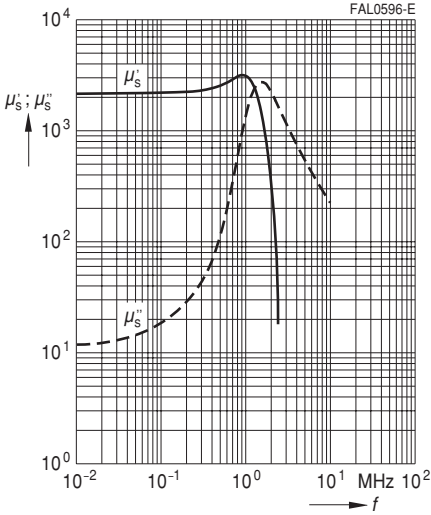

Initial permeability μ_i
versus temperature
(measured on R34 toroids, $\hat{B} \leq 0,25$ mT)

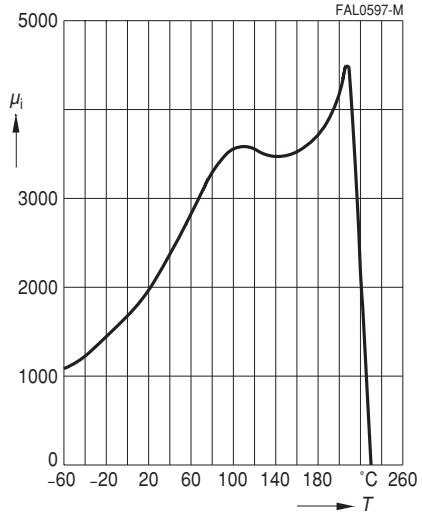

Amplitude permeability
versus AC field flux density
(measured on R34 toroids, $\hat{B} \leq 0,25$ mT)

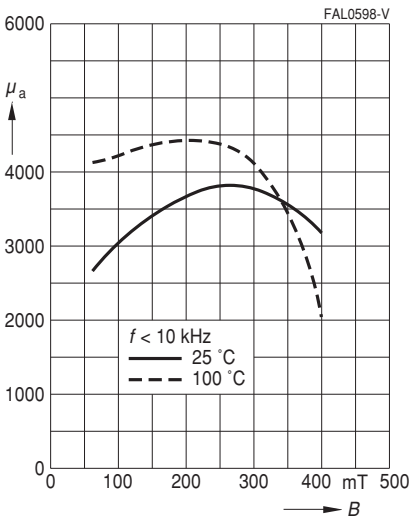

Dynamic magnetization curves
(typical values)
($f = 10 \text{ kHz}$, $T = 25 \text{ }^\circ\text{C}$)

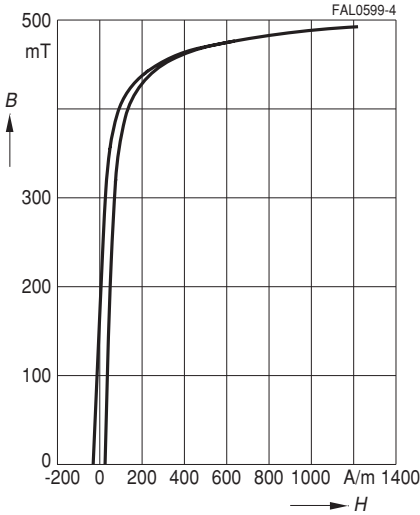

Dynamic magnetization curves
(typical values)
($f = 10 \text{ kHz}$, $T = 100 \text{ }^\circ\text{C}$)

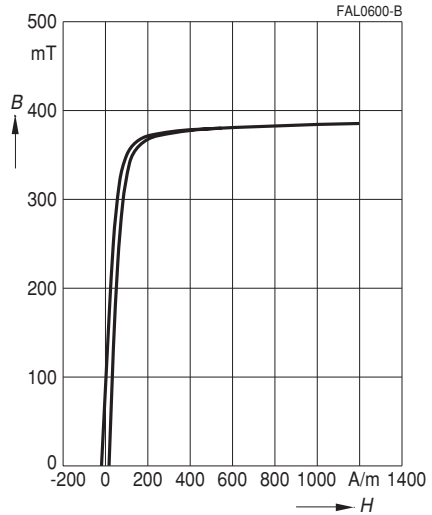

DC magnetic bias
of P, RM, PM and E cores
($\bar{B} \leq 0,25 \text{ mT}$, $f = 10 \text{ kHz}$, $T = 25 \text{ }^\circ\text{C}$)

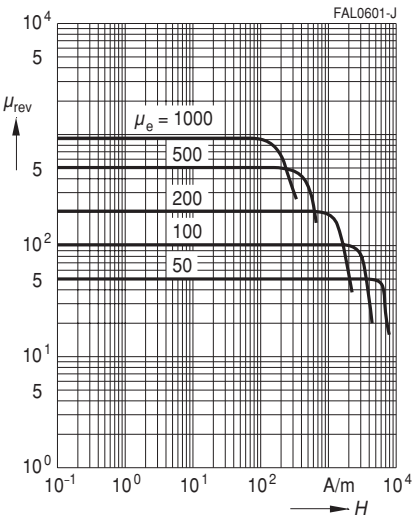

DC magnetic bias
of P, RM, PM and E cores
($\bar{B} \leq 0,25 \text{ mT}$, $f = 10 \text{ kHz}$, $T = 100 \text{ }^\circ\text{C}$)

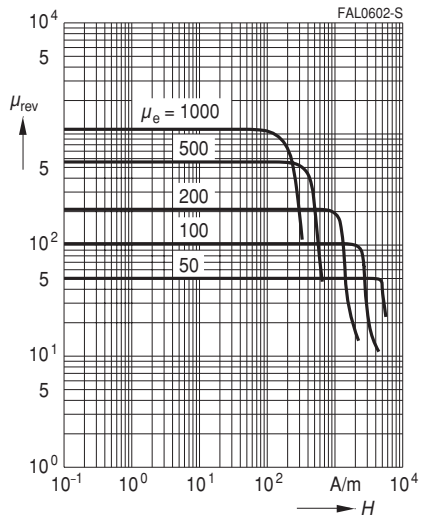

Relative core losses
versus AC field flux density
(measured on R34 toroids)

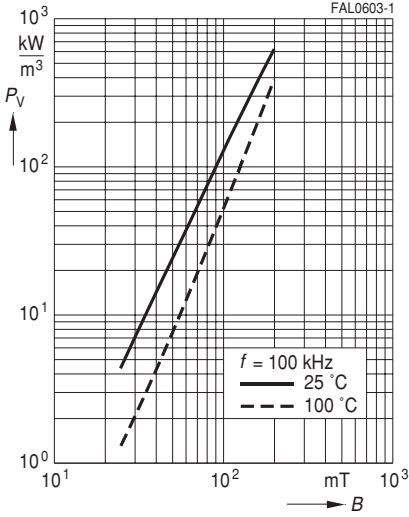

Relative core losses
versus temperature
(measured on R34 toroids)

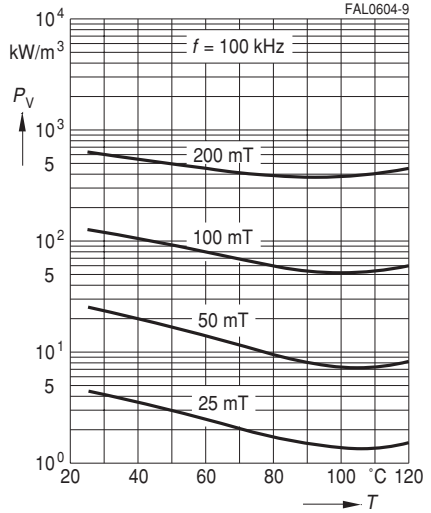

Relative core losses
versus frequency
(measured on R34 toroids)

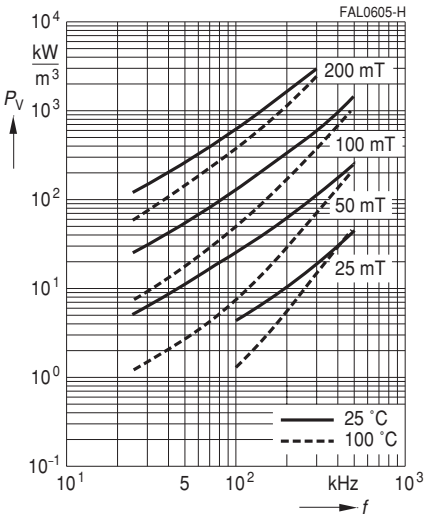

Complex permeability
versus frequency
(measured on R34 toroids, $\hat{B} \leq 0,25$ mT)

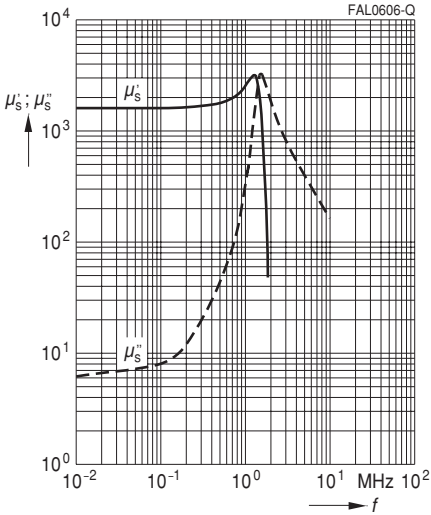

Initial permeability μ_i
versus temperature
(measured on R34 toroids, $\hat{B} \leq 0,25$ mT)

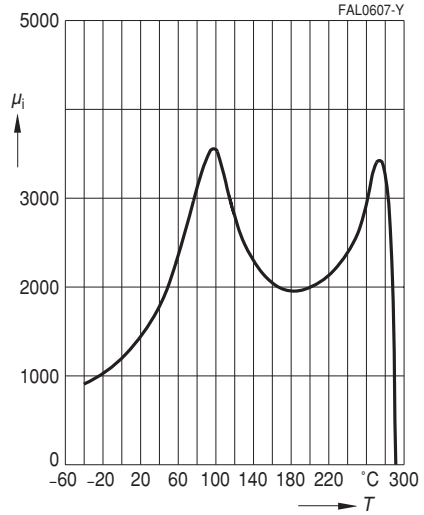

Amplitude permeability
versus AC field flux density
(measured on R34 toroids, $\hat{B} \leq 0,25$ mT)

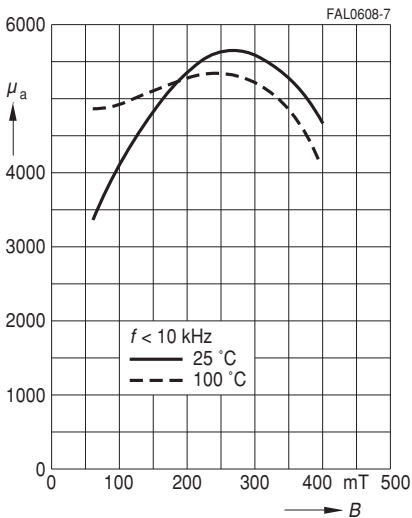

Dynamic magnetization curves
(typical values)
($f = 10 \text{ kHz}$, $T = 25 \text{ }^\circ\text{C}$)

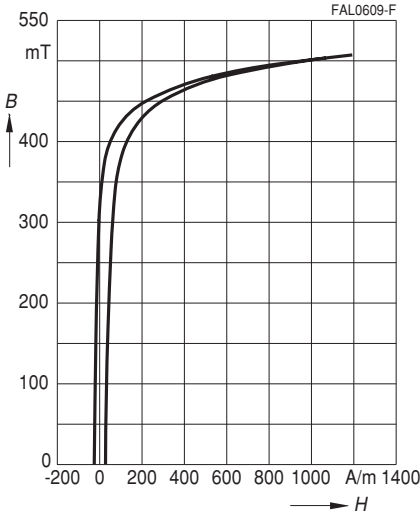

Dynamic magnetization curves
(typical values)
($f = 10 \text{ kHz}$, $T = 100 \text{ }^\circ\text{C}$)

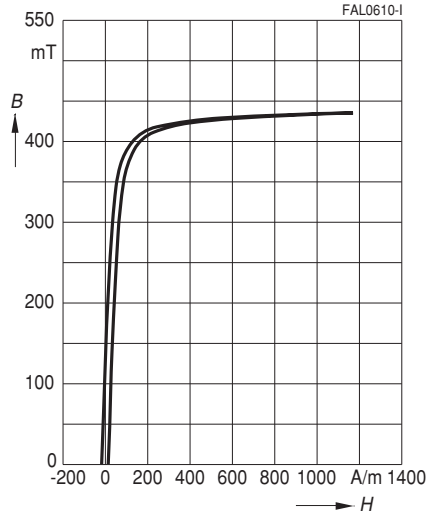

DC magnetic bias
measured on ETD cores
($\bar{B} \leq 0,25 \text{ mT}$, $f = 10 \text{ kHz}$, $T = 25 \text{ }^\circ\text{C}$)

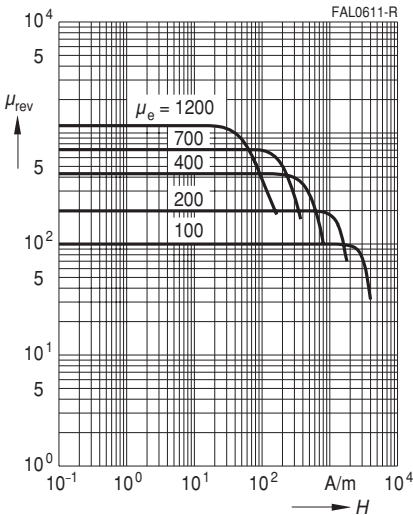

DC magnetic bias
measured on ETD cores
($\bar{B} \leq 0,25 \text{ mT}$, $f = 10 \text{ kHz}$, $T = 100 \text{ }^\circ\text{C}$)

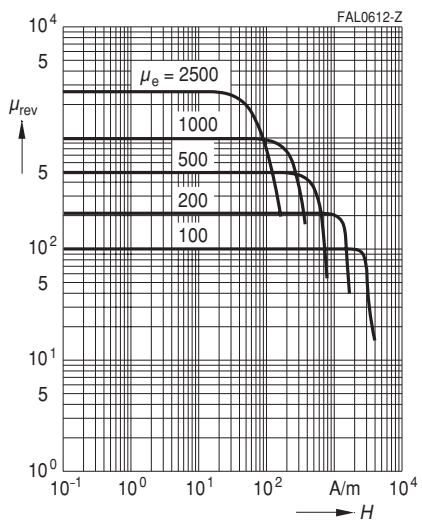

Relative core losses
versus AC field flux density
(measured on R34 toroids)

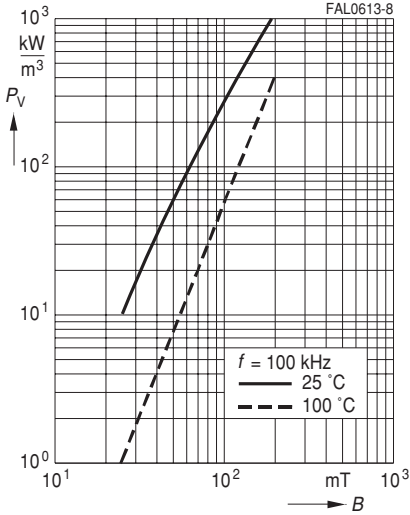

Relative core losses
versus temperature
(measured on R34 toroids)

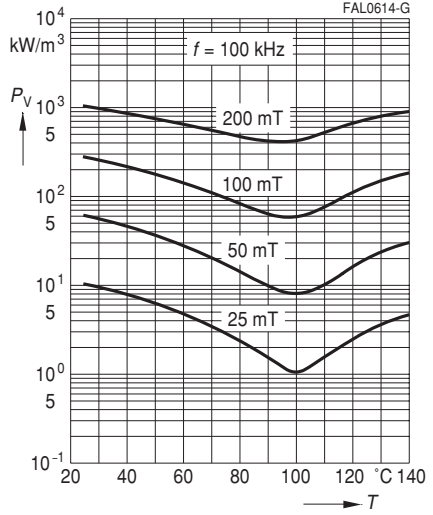

Relative core losses
versus frequency
(measured on R34 toroids)

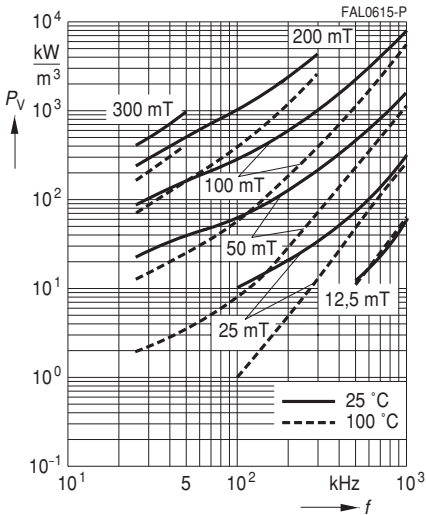

Complex permeability
versus frequency
(measured on R34 toroids, $\hat{B} \leq 0,25$ mT)

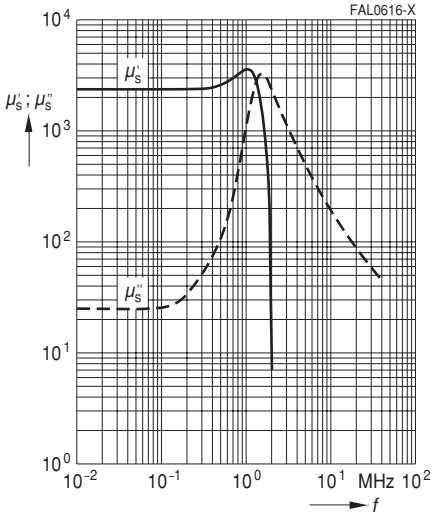

Initial permeability μ_i
versus temperature
(measured on R34 toroids, $\hat{B} \leq 0,25$ mT)

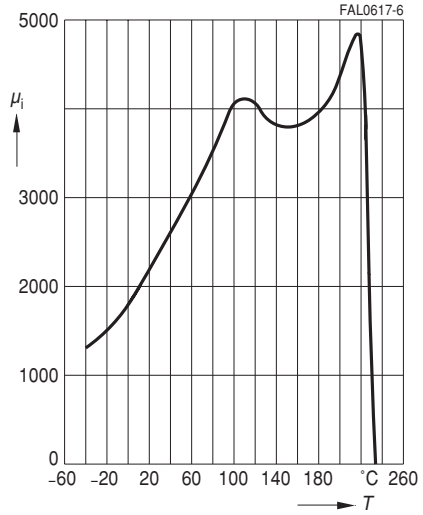

Amplitude permeability
versus AC field flux density
(measured on R34 toroids, $\hat{B} \leq 0,25$ mT)

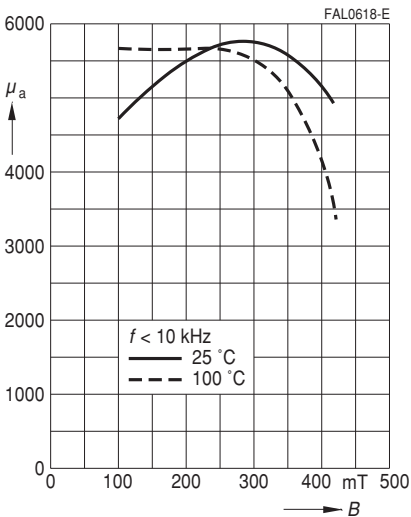

Dynamic magnetization curves
(typical values)
($f = 10 \text{ kHz}$, $T = 25 \text{ °C}$)

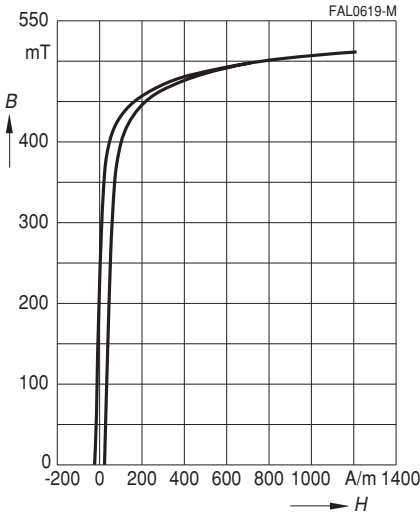

Dynamic magnetization curves
(typical values)
($f = 10 \text{ kHz}$, $T = 100 \text{ °C}$)

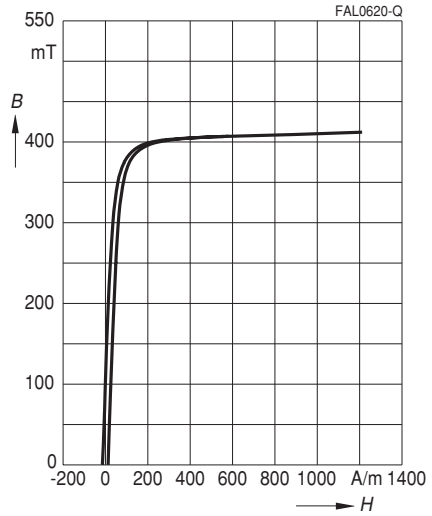

DC magnetic bias
measured on ETD cores
($\bar{B} \leq 0,25 \text{ mT}$, $f = 10 \text{ kHz}$, $T = 25 \text{ °C}$)

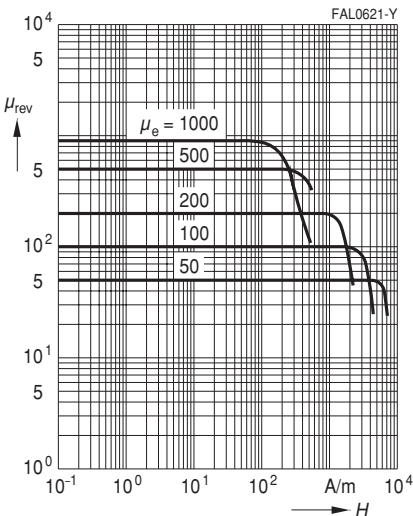

DC magnetic bias
measured on ETD cores
($\bar{B} \leq 0,25 \text{ mT}$, $f = 10 \text{ kHz}$, $T = 100 \text{ °C}$)

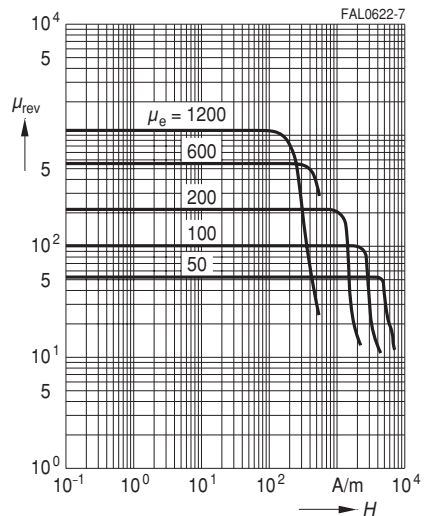

Relative core losses
versus AC field flux density
(measured on R34 toroids)

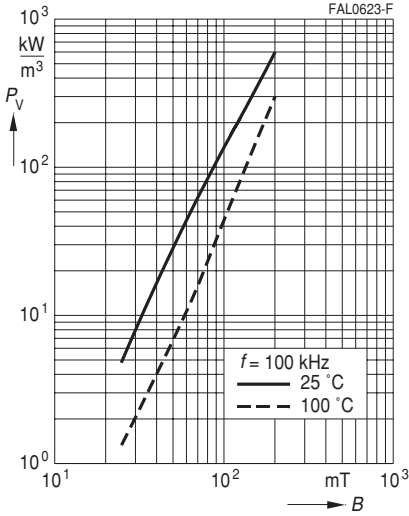

Relative core losses
versus temperature
(measured on R34 toroids)

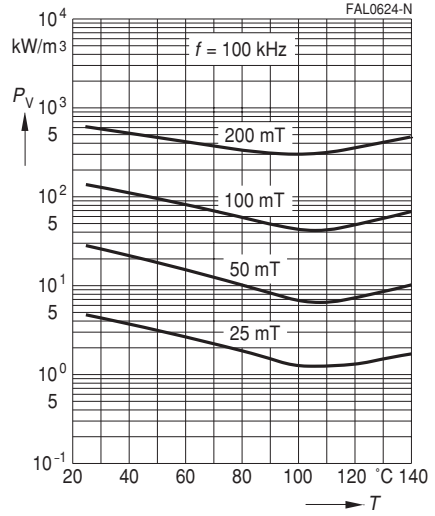

Relative core losses
versus frequency
(measured on R34 toroids)

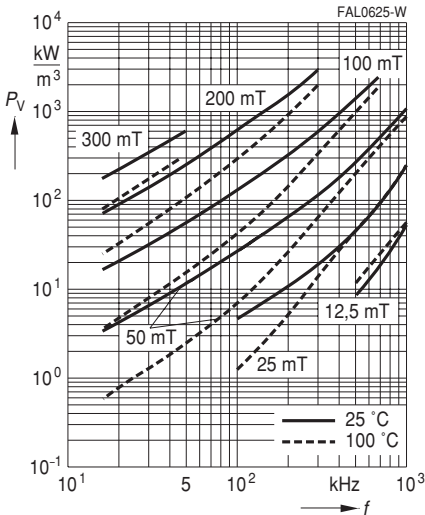

Complex permeability
versus frequency
(measured on R10 toroids, $\hat{B} \leq 0,25$ mT)

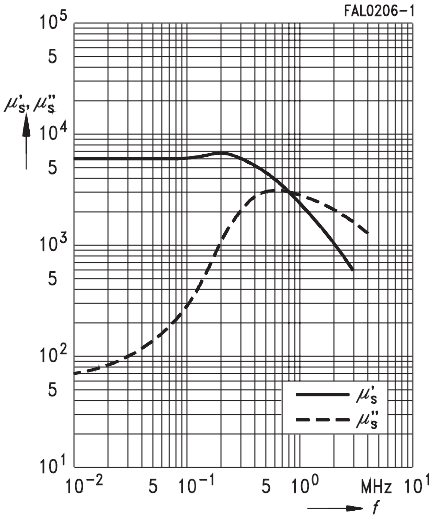

Initial permeability μ_i
versus temperature
(measured on R16 toroids, $\hat{B} \leq 0,25$ mT)

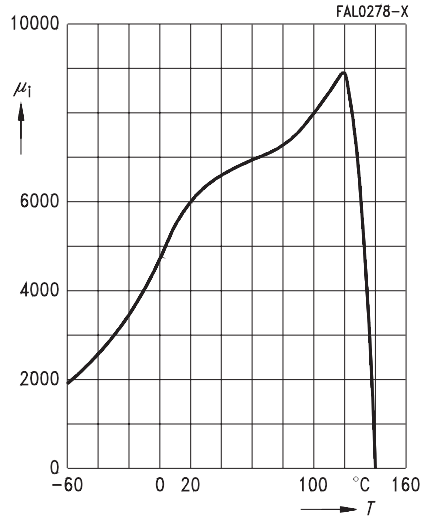

Variation of initial permeability
with temperature
(measured on R16 toroids, $\hat{B} \leq 0,25$ mT)

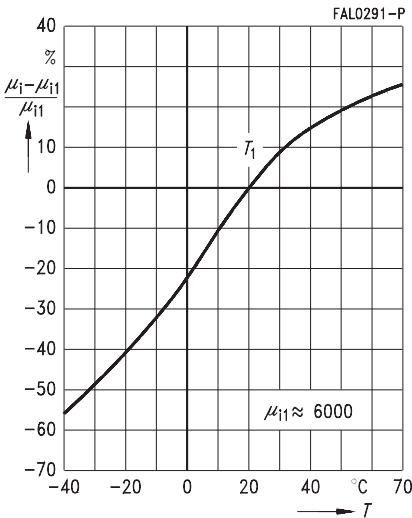

Relative loss factor
versus frequency
(measured on R16 toroids, $\hat{B} \leq 0,25$ mT)

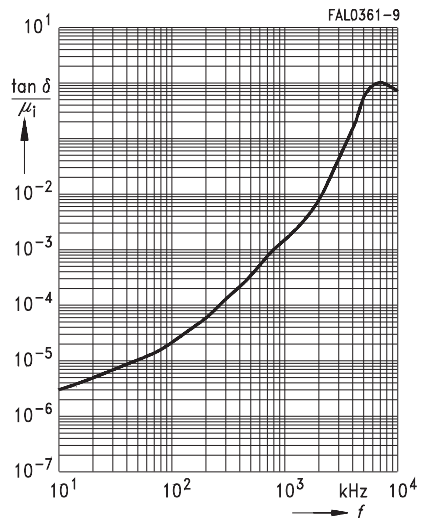

Dynamic magnetization curves
(typical values)
($f = 10 \text{ kHz}$, $T = 25 \text{ }^\circ\text{C}$)

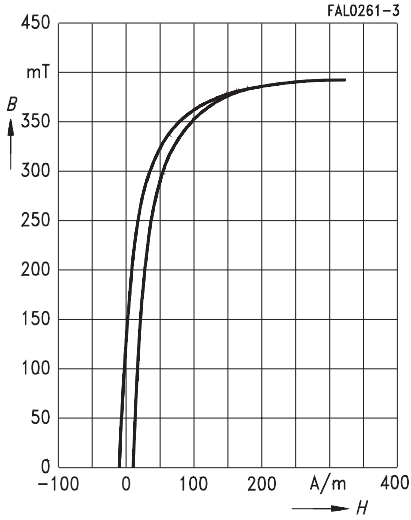

Dynamic magnetization curves
(typical values)
($f = 10 \text{ kHz}$, $T = 100 \text{ }^\circ\text{C}$)

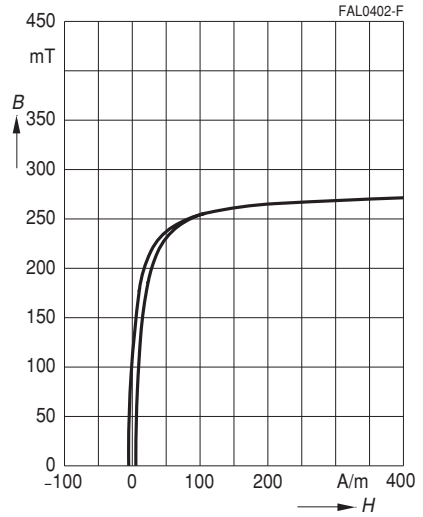

DC magnetic bias
(measured on RM cores, typical values)
($\bar{B} \leq 0,25 \text{ mT}$, $f = 10 \text{ kHz}$, $T = 25 \text{ }^\circ\text{C}$)

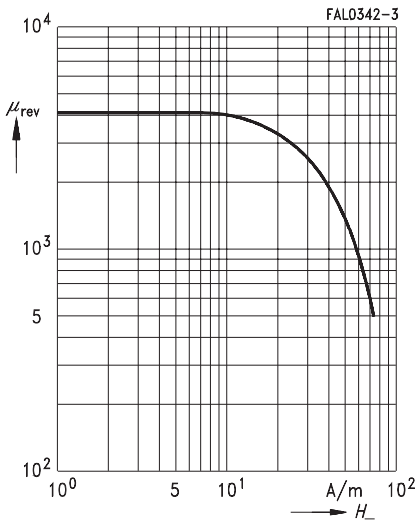

Complex permeability
versus frequency
(measured on R16 toroids, $\hat{B} \leq 0,25$ mT)

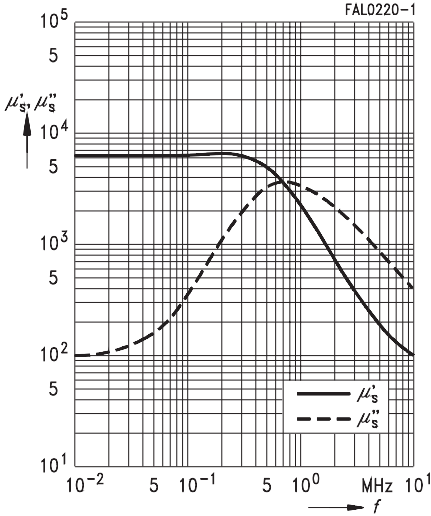

Initial permeability μ_i
versus temperature
(measured on R22 toroids, $\hat{B} \leq 0,25$ mT)

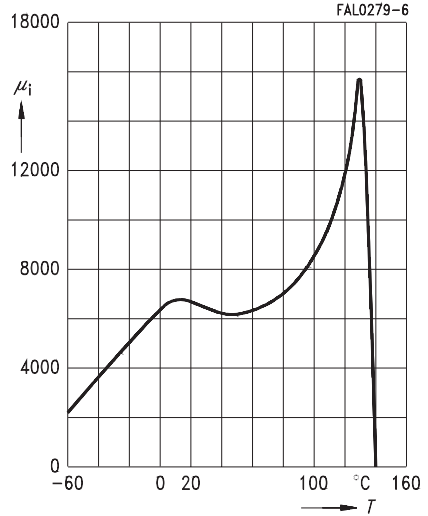

Variation of initial permeability
with temperature
(measured on R22 toroids, $\hat{B} \leq 0,25$ mT)

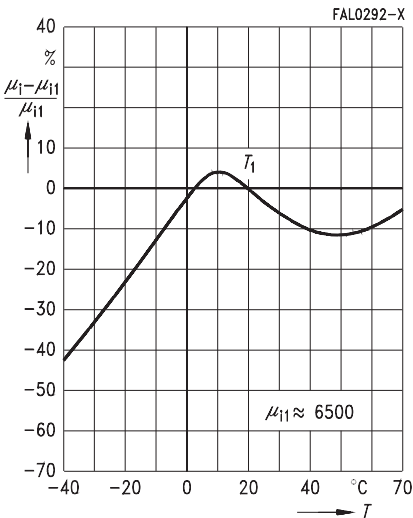

Relative loss factor
versus frequency
(measured on R16 toroids, $\hat{B} \leq 0,25$ mT)

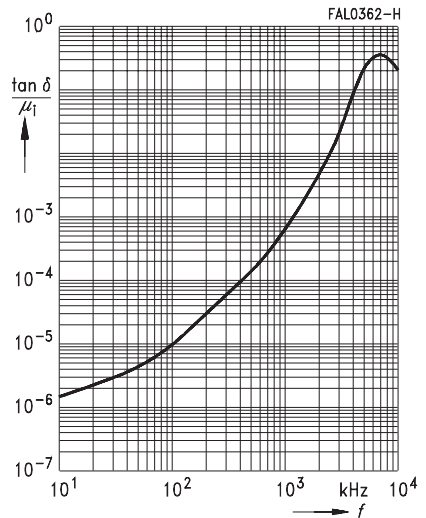

Dynamic magnetization curves
(typical values)
($f = 10 \text{ kHz}$, $T = 25 \text{ }^\circ\text{C}$)

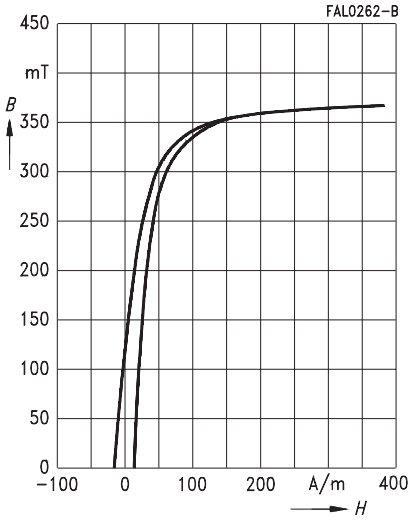

Dynamic magnetization curves
(typical values)
($f = 10 \text{ kHz}$, $T = 100 \text{ }^\circ\text{C}$)

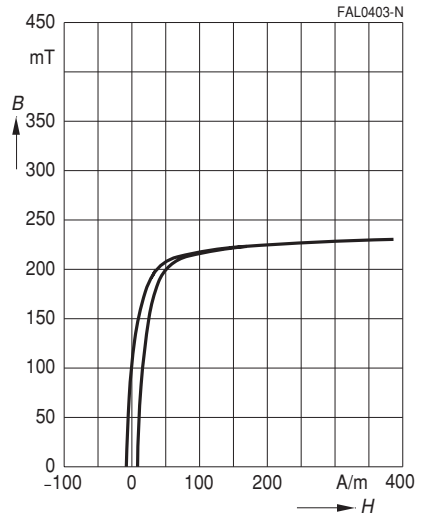

DC magnetic bias
(measured on RM cores, typical values)
($\hat{B} \leq 0,25 \text{ mT}$, $f = 10 \text{ kHz}$, $T = 25 \text{ }^\circ\text{C}$)

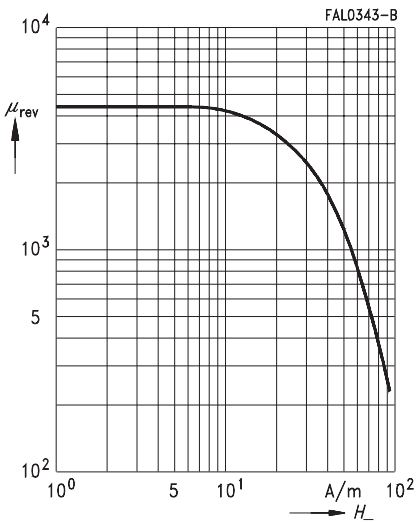

Complex permeability
versus frequency
(measured on R10 toroids, $\hat{B} \leq 0,25$ mT)

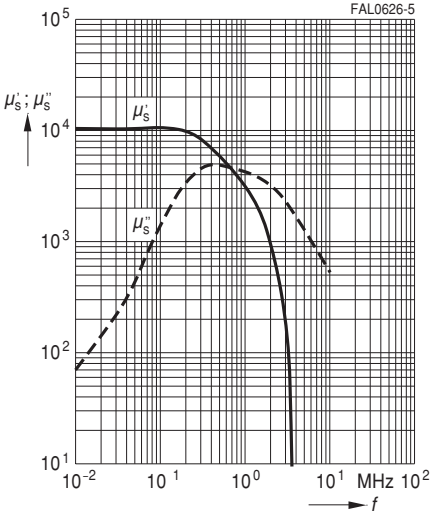

Initial permeability μ_i
versus temperature
(measured on R10 toroids, $\hat{B} \leq 0,25$ mT)

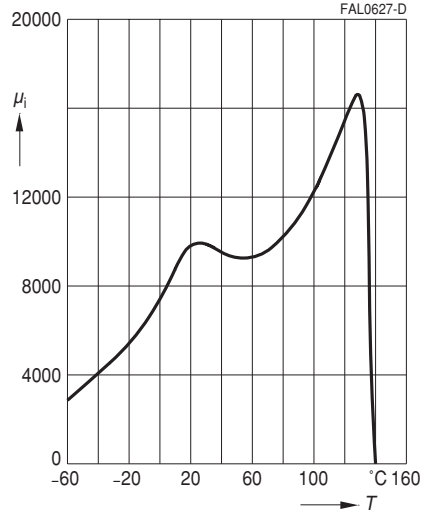

Variation of initial permeability
with temperature
(measured on R10 toroids, $\hat{B} \leq 0,25$ mT)

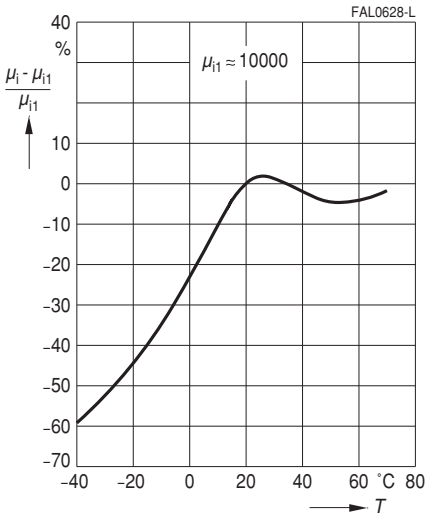

Relative loss factor
versus frequency
(measured on R10 toroids, $\hat{B} \leq 0,25$ mT)

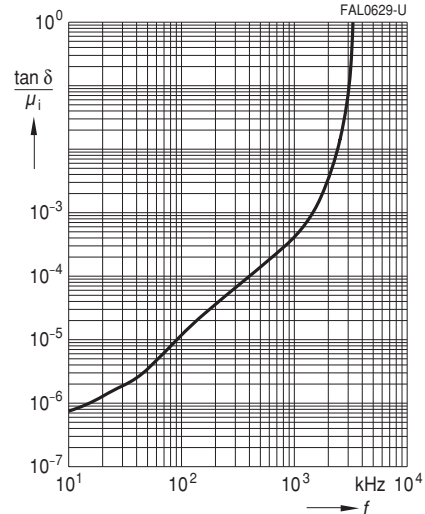

Dynamic magnetization curves
(typical values)
($f = 10 \text{ kHz}$, $T = 25 \text{ °C}$)

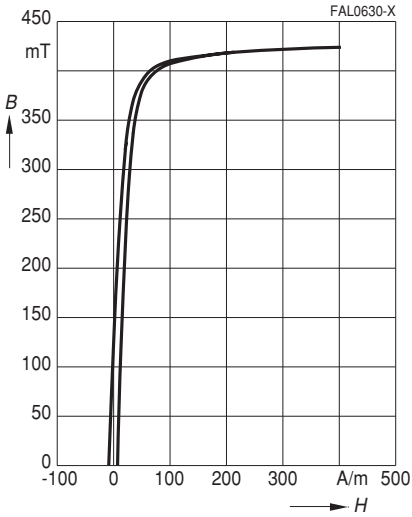

Dynamic magnetization curves
(typical values)
($f = 10 \text{ kHz}$, $T = 100 \text{ °C}$)

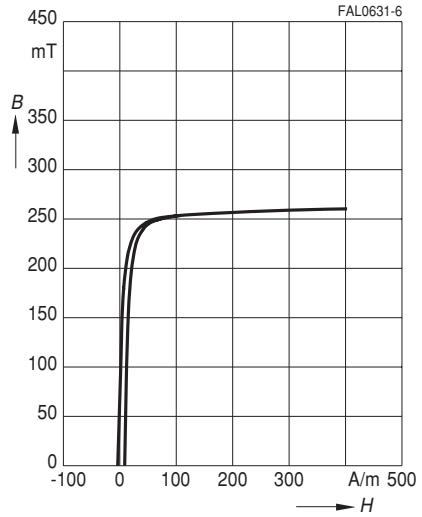

DC magnetic bias
(measured on RM cores, typical values)
($\bar{B} \leq 0,25 \text{ mT}$, $f = 10 \text{ kHz}$, $T = 25 \text{ °C}$)

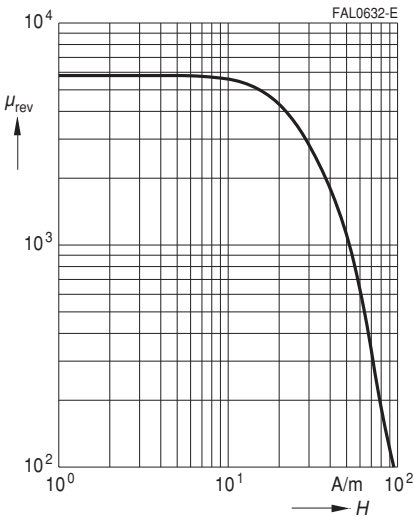

Complex permeability
versus frequency
(measured on R9,5 toroids, $\hat{B} \leq 0,25$ mT)

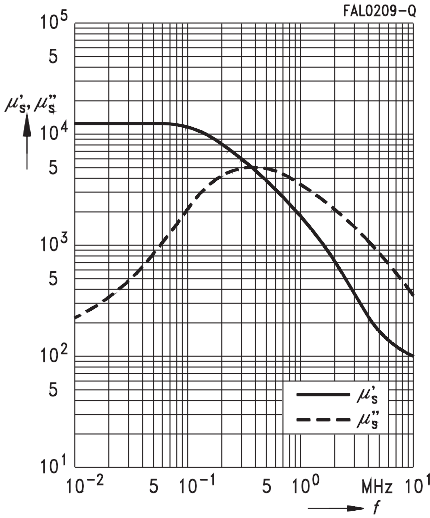

Initial permeability μ_i
versus temperature
(measured on R9,5 toroids, $\hat{B} \leq 0,25$ mT)

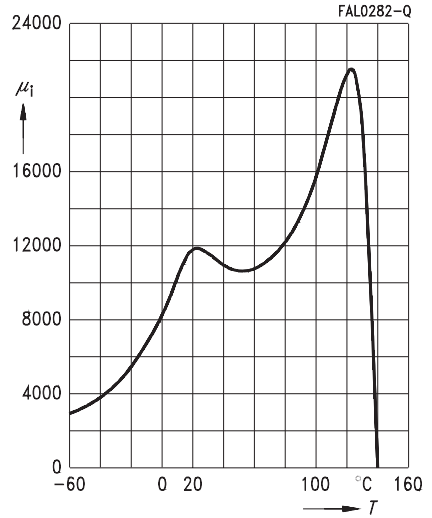

Variation of initial permeability
with temperature
(measured on R9,5 toroids, $\hat{B} \leq 0,25$ mT)

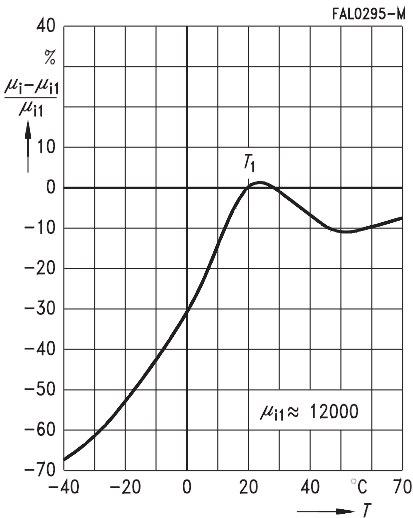

Relative loss factor
versus frequency
(measured on R9,5 toroids, $\hat{B} \leq 0,25$ mT)

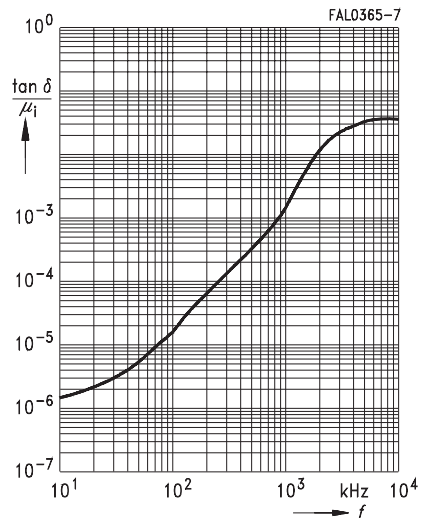

Dynamic magnetization curves
(typical values)
($f = 10 \text{ kHz}$, $T = 25 \text{ }^\circ\text{C}$)

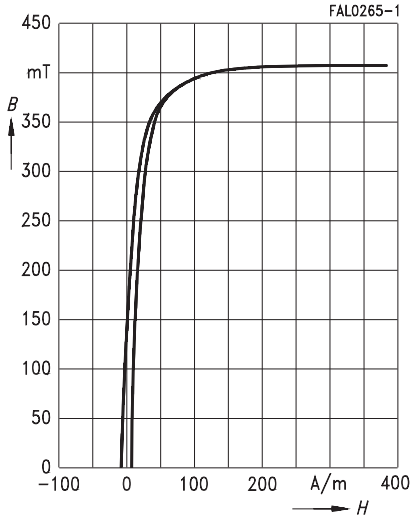

Dynamic magnetization curves
(typical values)
($f = 10 \text{ kHz}$, $T = 100 \text{ }^\circ\text{C}$)

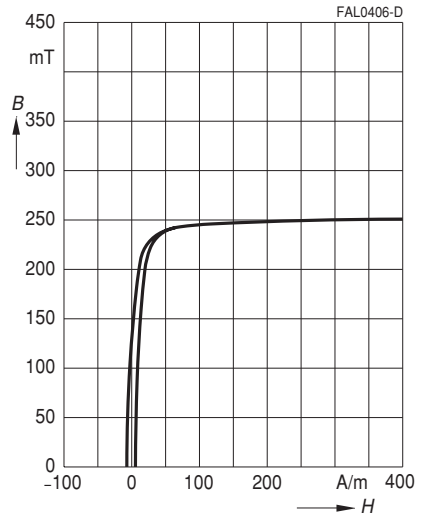

DC magnetic bias
(measured on RM cores, typical values)
($\bar{B} \leq 0,25 \text{ mT}$, $f = 10 \text{ kHz}$, $T = 25 \text{ }^\circ\text{C}$)

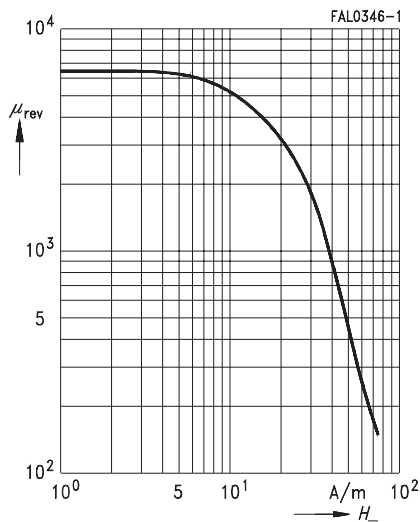

Complex permeability
versus frequency
(measured on R10 toroids, $\hat{B} \leq 0,25$ mT)

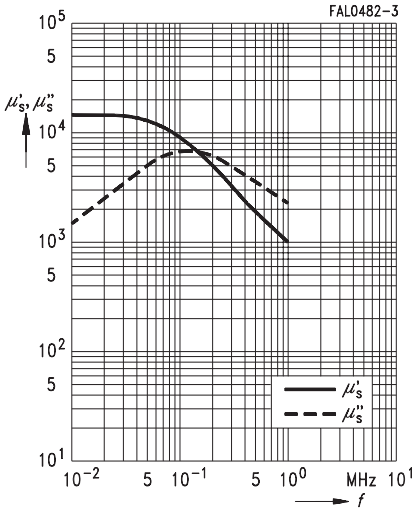

Initial permeability μ_i
versus temperature
(measured on R10 toroids, $\hat{B} \leq 0,25$ mT)

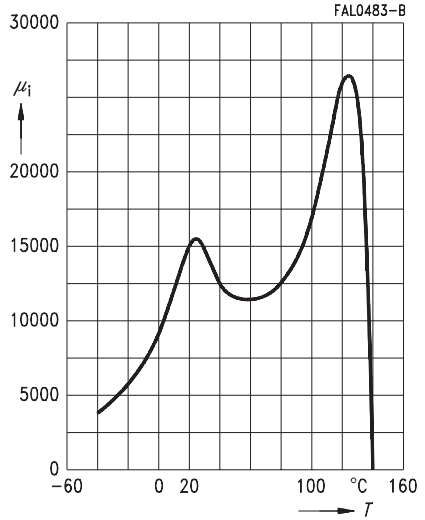

Variation of initial permeability
with temperature
(measured on R10 toroids, $\hat{B} \leq 0,25$ mT)

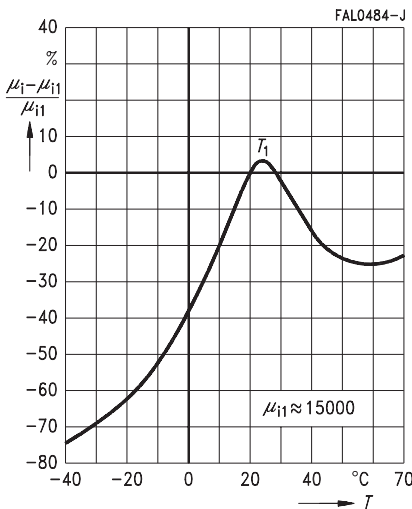

Relative loss factor
versus frequency
(measured on R10 toroids, $\hat{B} \leq 0,25$ mT)

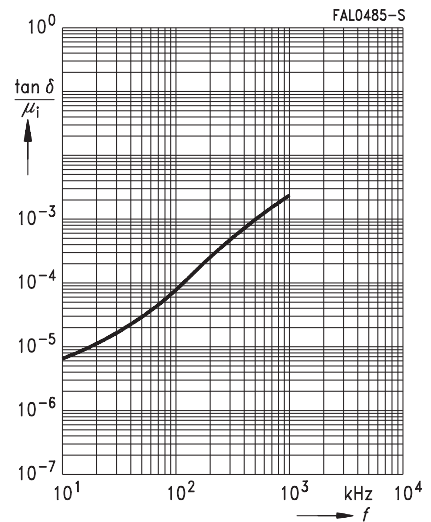

Dynamic magnetization curves
(typical values)
($f = 10 \text{ kHz}$, $T = 25 \text{ }^\circ\text{C}$)

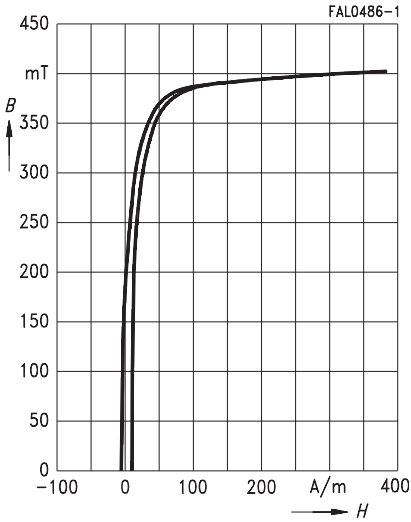

Dynamic magnetization curves
(typical values)
($f = 10 \text{ kHz}$, $T = 100 \text{ }^\circ\text{C}$)

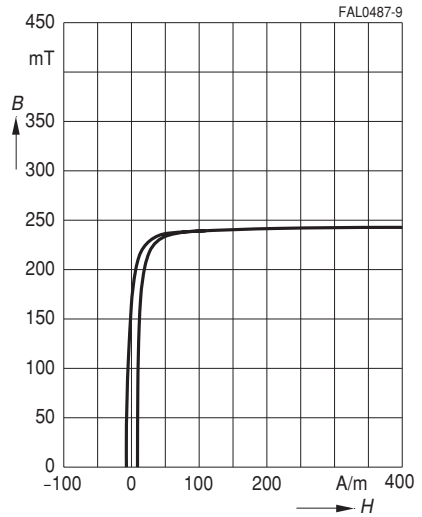

Complex permeability
versus frequency
(measured on R12,5 toroids, $\hat{B} \leq 0,25$ mT)

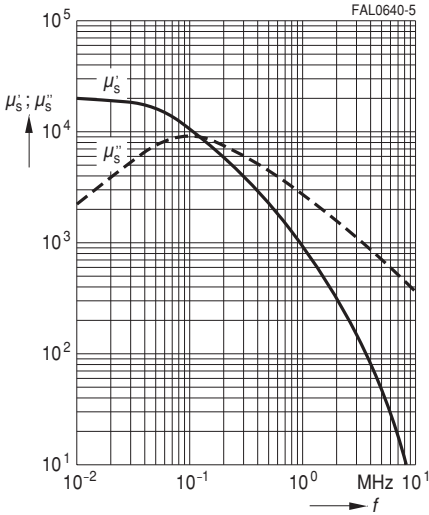

Initial permeability μ_i
versus temperature
(measured on R12,5 toroids, $\hat{B} \leq 0,25$ mT)

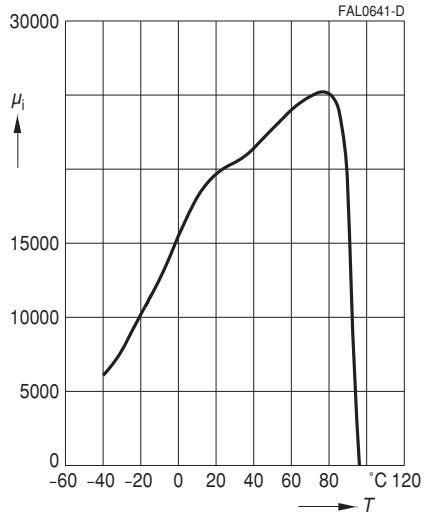

Variation of initial permeability
with temperature
(measured on R12,5 toroids, $\hat{B} \leq 0,25$ mT)

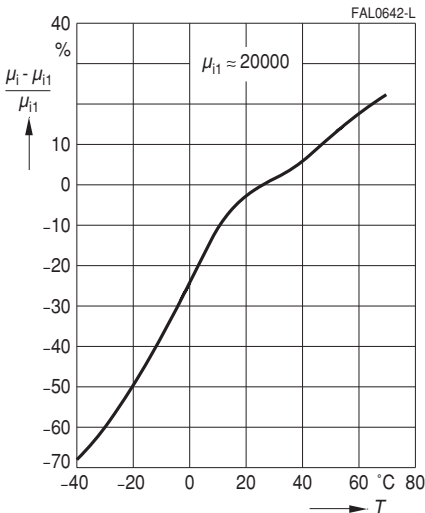

Relative loss factor
versus frequency
(measured on R12,5 toroids, $\hat{B} \leq 0,25$ mT)

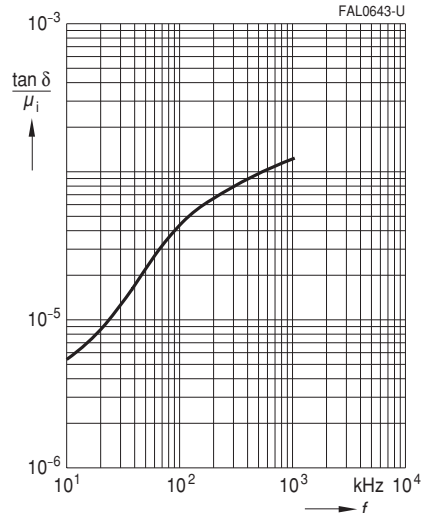

Dynamic magnetization curves

(typical values)

($f = 10 \text{ kHz}$, $T = 25 \text{ °C}$)



Complex permeability
versus frequency
(measured on R17 toroids, $\hat{B} \leq 0,25 \text{ mT}$)

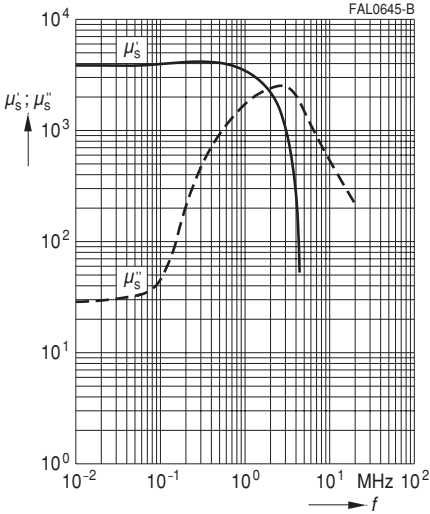

Initial permeability μ_i
versus temperature
(measured on R17 toroids, $\hat{B} \leq 0,25 \text{ mT}$)

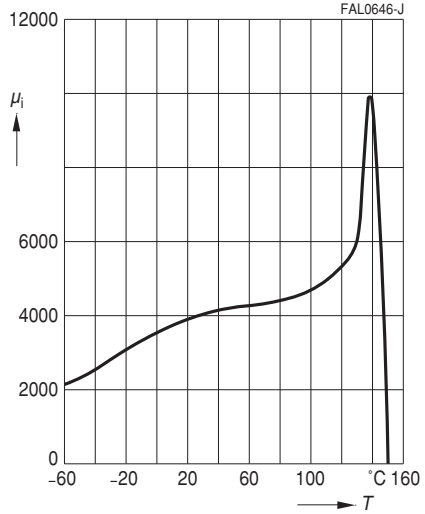

Variation of initial permeability
with temperature
(measured on R17 toroids, $\hat{B} \leq 0,25 \text{ mT}$)

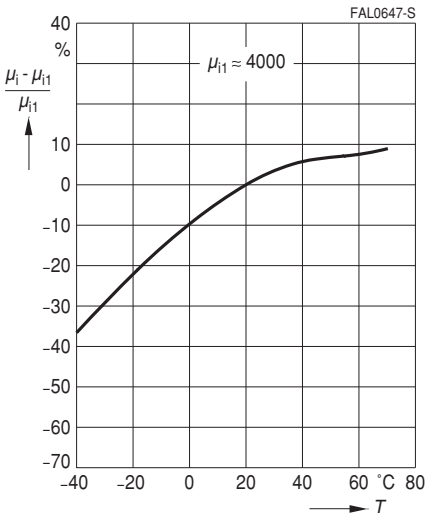

Relative loss factor
versus frequency
(measured on R17 toroids, $\hat{B} \leq 0,25 \text{ mT}$)

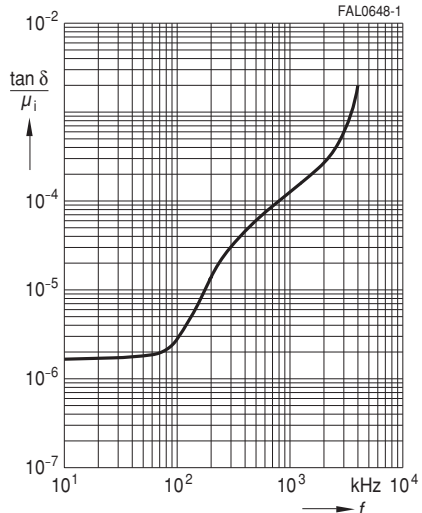

Dynamic magnetization curves
(typical values)
($f = 10 \text{ kHz}$, $T = 25 \text{ °C}$)

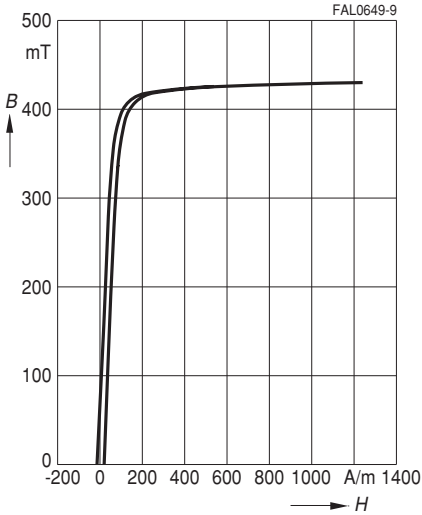

Dynamic magnetization curves
(typical values)
($f = 10 \text{ kHz}$, $T = 100 \text{ °C}$)

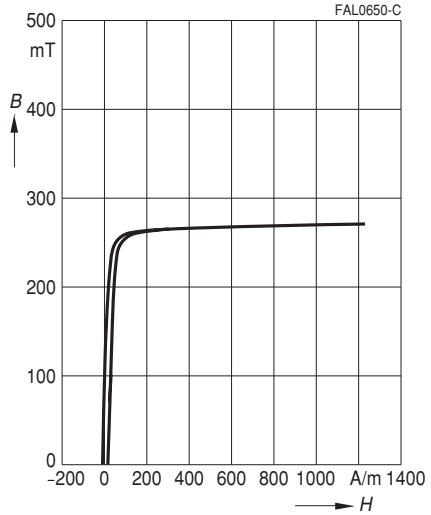

Reversible permeability versus temperature
(measured on toroids at $f = 100 \text{ kHz}$,
 $H_{DC} = 27,5 \text{ A/m}$, $\hat{B} = 6 \text{ mT}$)

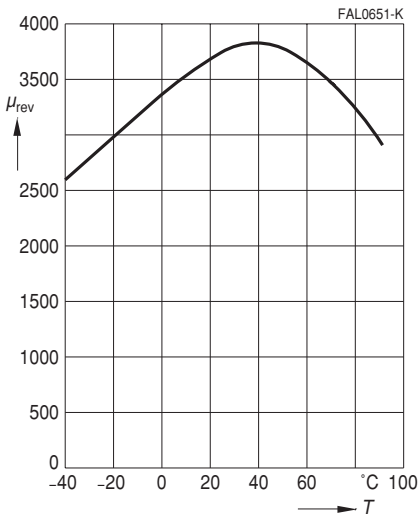

Complex permeability
versus frequency
(measured on R29 toroids, $\hat{B} \leq 0,25$ mT)

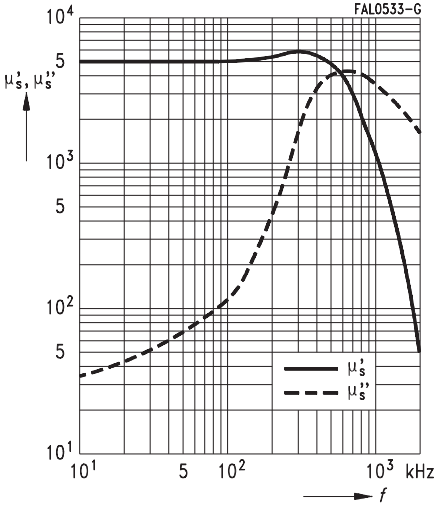

Initial permeability μ_i
versus temperature
(measured on R29 toroids, $\hat{B} \leq 0,25$ mT)

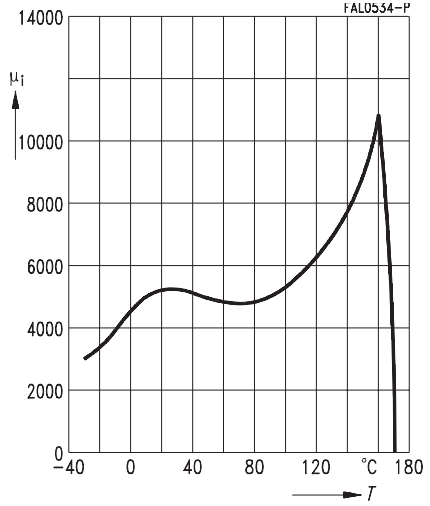

Variation of initial permeability
with temperature
(measured on R29 toroids, $\hat{B} \leq 0,25$ mT)

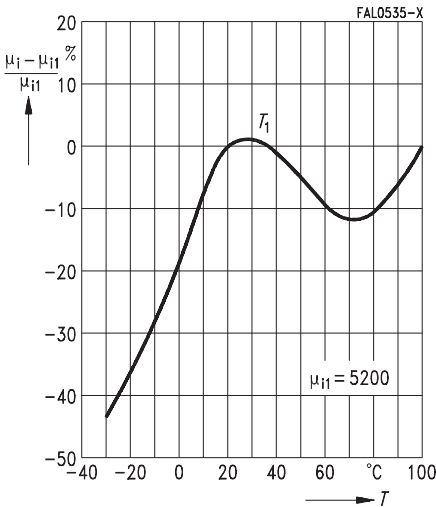

Relative loss factor
versus frequency
(measured on R29 toroids, $\hat{B} \leq 0,25$ mT)

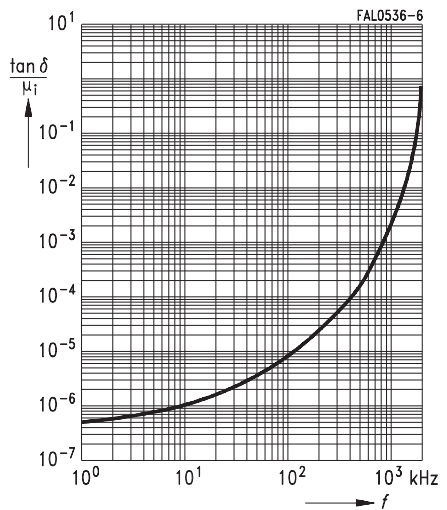

Dynamic magnetization curves

(typical values)

($f = 10 \text{ kHz}$, $T = 25 \text{ °C}$)

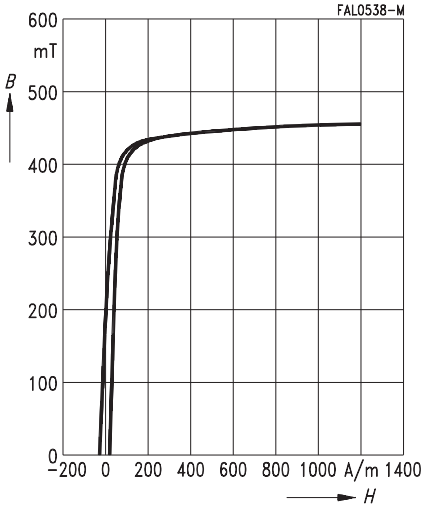

Dynamic magnetization curves

(typical values)

($f = 10 \text{ kHz}$, $T = 100 \text{ °C}$)

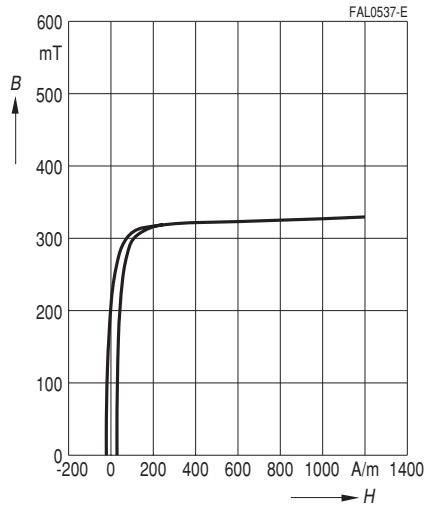

DC magnetic bias

(measured on RM cores, typical values)

($\hat{B} \leq 0,25 \text{ mT}$, $f = 10 \text{ kHz}$, $T = 25 \text{ °C}$)

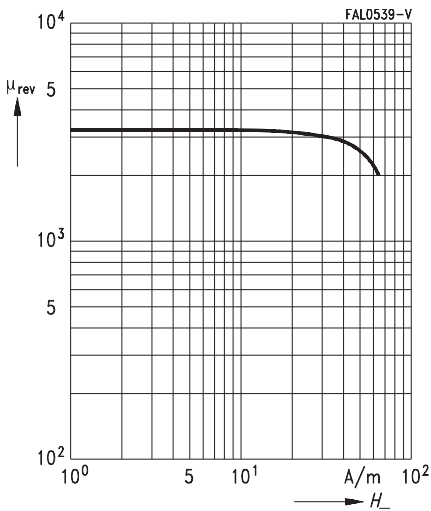

5 Plastic materials, manufacturers and UL numbers

- RM coil formers of thermosetting plastic, color code blue (molded-in pins):
Bakelite UP 3420® [E 61040 (M)]; Bakelite
- RM, EP and EFD coil formers of thermosetting plastic, color code black (post-inserted pins):
Sumikon PM 9630® [E41429 (M)]; Sumitomo Bakelite
- RM, EP and EFD coil formers of thermosetting plastic, color code green (post-inserted pins):
Vyncolit/X611® [E167521 (M)]; Vyncolit NV
- EP7 special coil former of thermosetting plastic:
AMC 2568® [E 48036 (M)], blue; Synres-Almoco BV
- RM power, P, PM, E, ETD, ER coil formers
and terminal carriers P7×4, P9×5, P11×7, P36×22 (Polyterephthalate):
Valox 420-SE0® [E 45329 (M)], black; General Electric Plastics
Vestodur GF30-FR1® [E66645 (M)], black; Degussa Hüls
Crastin CE 7931® [E 69578 (M)], black; DuPont
Pocan 4235® [E 41613 (M)], black; Bayer
Arnite TV4264SN® [E 47960 (M)], black; DSM
Rynite FR 530® [E 69578 (M)], black; DuPont
- Terminal carrier P4,6×4,1 (Polyether Ketone):
Luvocom 1105/GF/20/EM® [---], natural; Lehmann u. Voss & Co.
- Terminal carriers P14×8, P18×11, P22×13, P26×16, P30×19 (Polyterephthalate):
Pocan 4235® [E 41613 (M)], grey; Bayer
- SMD coil formers (Liquid cristal polymer):
Sumika Super E4008® [E 54705 (M)], black; Sumitomo Chemical
Zenite 7130® [E 123598 (M)], black; DuPont
Vectra C 130 [E 83005 (M)], black; Ticona
- Insulating washers:
Makrofol KL 3 – 1005/1 [E 41613 (M)], natural; Bayer
Pokalon SN [E 167358 (M)], natural; LOFO HIGH TECH FILM

Rights to change material reserved.

Further information is given on the packing label.

The trade names are registered trademarks of the listed manufacturers.

Further information to the UL certifications are available in the internet under <http://www.UL.com>

Here you get the newest update of the yellow card.

EPCOS is an assigned molder with the UL file no. E 178623 (M).

The assigned designation is A 1770.

Herausgegeben von EPCOS AG

Marketing Kommunikation, Postfach 80 17 09, 81617 München, DEUTSCHLAND

© EPCOS AG 2000. Alle Rechte vorbehalten. Vervielfältigung, Veröffentlichung, Verbreitung und Verwertung dieser Broschüre und ihres Inhalts ohne ausdrückliche Genehmigung der EPCOS AG nicht gestattet.

Mit den Angaben in dieser Broschüre werden die Bauelemente spezifiziert, keine Eigenschaften zugesichert. Bestellungen unterliegen den vom ZVEI empfohlenen Allgemeinen Lieferbedingungen für Erzeugnisse und Leistungen der Elektroindustrie, soweit nichts anderes vereinbart wird.

Diese Broschüre ersetzt die vorige Ausgabe.

Fragen über Technik, Preise und Liefermöglichkeiten richten Sie bitte an den Ihnen nächstgelegenen Vertrieb der EPCOS AG oder an unsere Vertriebsgesellschaften im Ausland.

Bauelemente können aufgrund technischer Erfordernisse Gefahrstoffe enthalten. Auskünfte darüber bitten wir unter Angabe des betreffenden Typs ebenfalls über die zuständige Vertriebsgesellschaft einzuholen.

Published by EPCOS AG

Marketing Communications, P.O. Box 80 17 09, 81617 Munich, GERMANY

© EPCOS AG 2000. All Rights Reserved. Reproduction, publication and dissemination of this brochure and the information contained therein without EPCOS' prior express consent is prohibited.

The information contained in this brochure describes the type of component and shall not be considered as guaranteed characteristics. Purchase orders are subject to the General Conditions for the Supply of Products and Services of the Electrical and Electronics Industry recommended by the ZVEI (German Electrical and Electronic Manufacturers' Association), unless otherwise agreed.

This brochure replaces the previous edition.

For questions on technology, prices and delivery please contact the Sales Offices of EPCOS AG or the international Representatives.

Due to technical requirements components may contain dangerous substances. For information on the type in question please also contact one of our Sales Offices.