

np*: Connectors not populated, may be added for own Software development

Zust.	Änderung	Datum	Name	Projekt:	Test-Board_CPD02-TX_02-a	
-00	Erstausgabe	24.10.06	RM	Seite:	PCB	
-01	Photocoupler, VReg updated	12.02.07	RM	Variante:	<alle>	
-02	L2, L3 single parts	29.03.07	RM			
-02a	R23 changed to 180R	16.04.07	RM			

Datum:	Test-Board_CPD02-TX_02-a.T3001	Blatt	1
Datum:	16.04.2007	100,00%	1 Bl.



Reimesch Kommunikationssysteme GmbH
Friedrich-Ebert-Str. 1 D-51429 Bergisch Gladbach

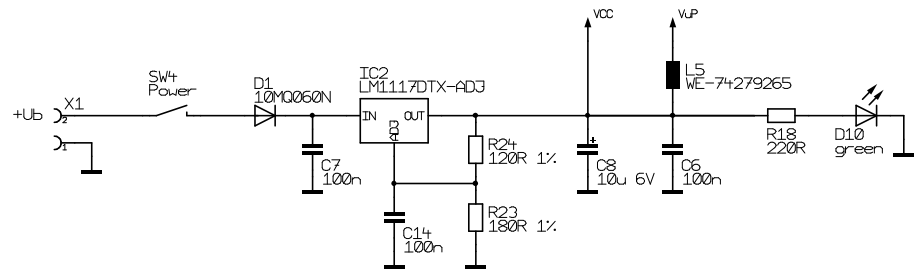
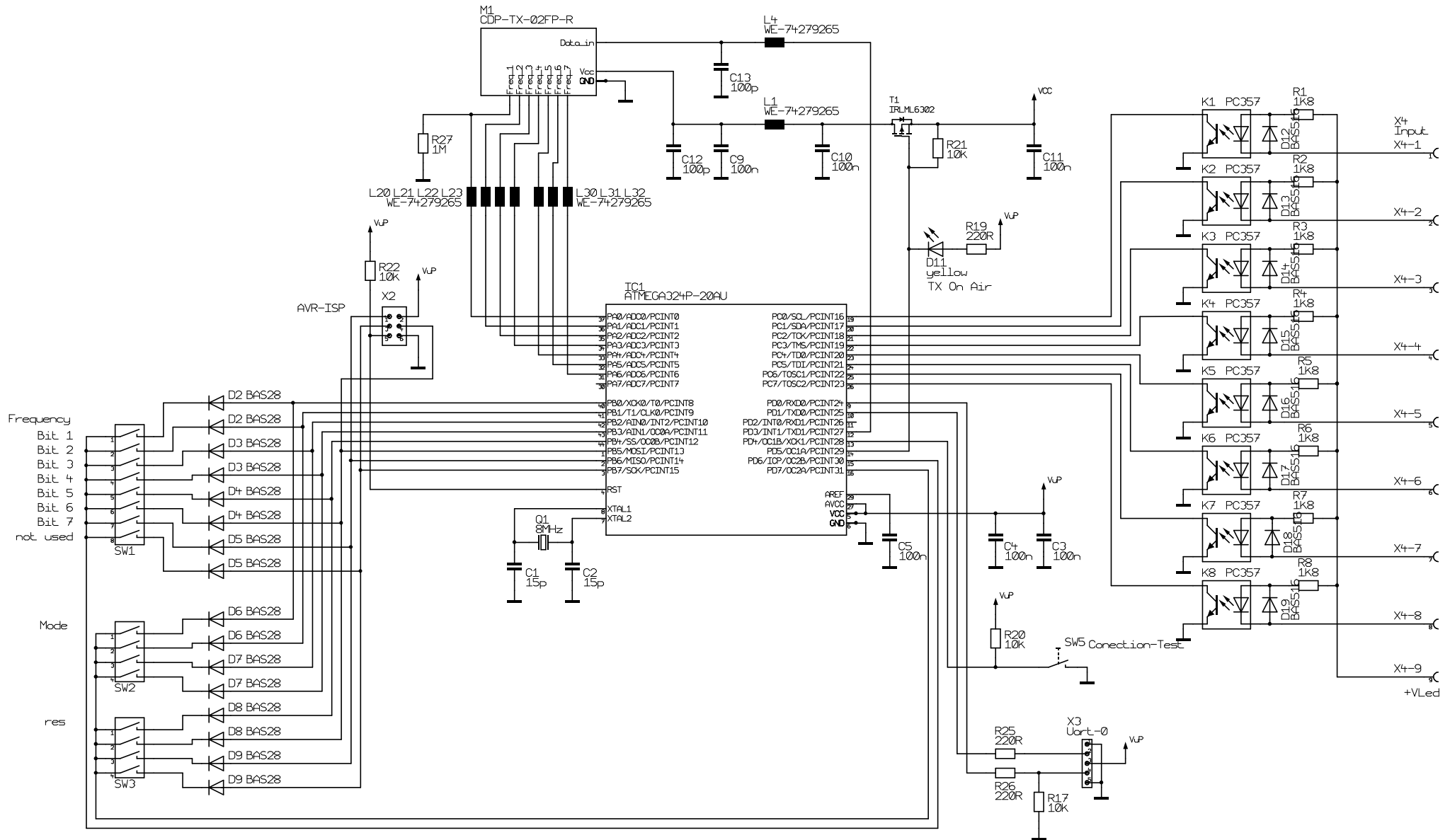

Zust.	Änderung	Datum	Name	Projekt:	Test-Board_CPD02-TX_02-a	
-00	Erstausgabe	24.10.06	RM	Variante:	<alle>	
-01	Photocoupler_VReg updated	12.02.07	RM			
-02	L2, L3 single parts	29.03.07	RM			
-02a	R23 changed to 180R	16.04.07	RM			
				Datum:	Test-Board_CPD02-TX_02-a.T3001	Blatt 1
				Datum:	16.04.2007	1 Bl.

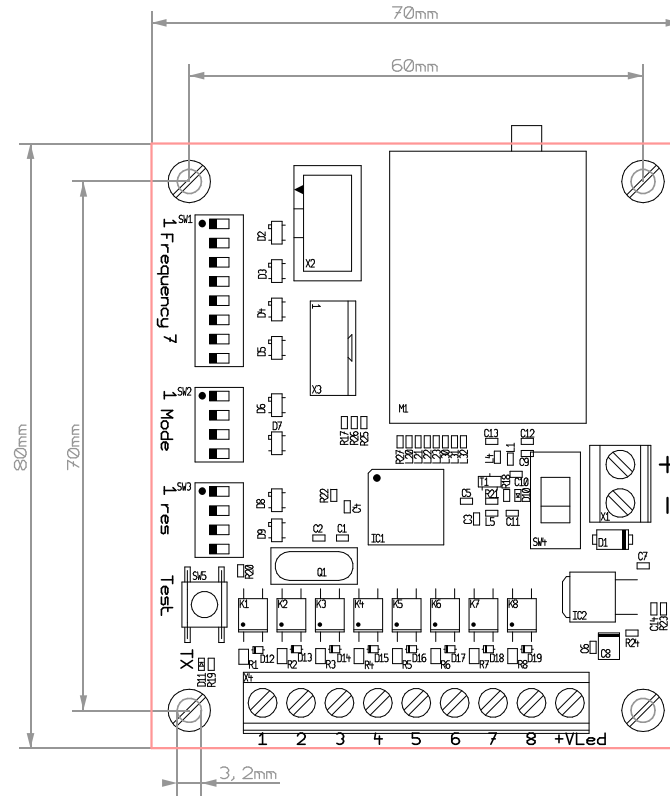

Zust.	Änderung	Datum	Name	Projekt:	Test-Board_CPD02-TX_02-a	
-00	Erstausgabe	24.10.06	RM	Seite:	PCB	
-01	Photocoupler, VReg updated	12.02.07	RM	Variante:	<alle>	
-02	L2, L3 single parts	29.03.07	RM			
-02a	R23 changed to 180R	16.04.07	RM			



Reimesch Kommunikationssysteme GmbH
 Friedrich-Ebert-Str. 1 D-51429 Bergisch Gladbach

Datei:	Test-Board_CPD02-TX_02-a.T3001	Blatt	1
Datum:	16.04.2007		

100,00% 1 Bl.

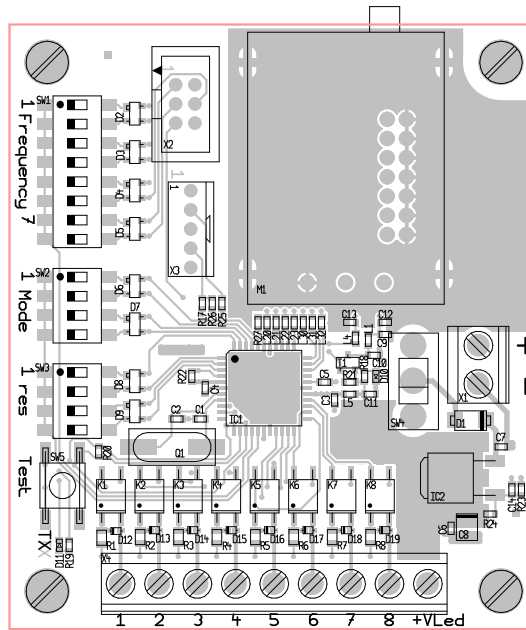

Zust.	Änderung	Datum	Name	Projekt:	Test-Board_CPD02-TX_02-a	
-00	Erstausgabe	24.10.06	RM	Seite:	PCB	
-01	Photocoupler, VReg updated	12.02.07	RM	Variante:	<alle>	
-02	L2, L3 single parts	29.03.07	RM			
-02a	R23 changed to 180R	16.04.07	RM			



Reimesch Kommunikationssysteme GmbH
Friedrich-Ebert-Str. 1 D-51429 Bergisch Gladbach

Datei:	Test-Board_CPD02-TX_02-a.T3001	Blatt	1
Datum:	16.04.2007	100,00%	1 Bl.

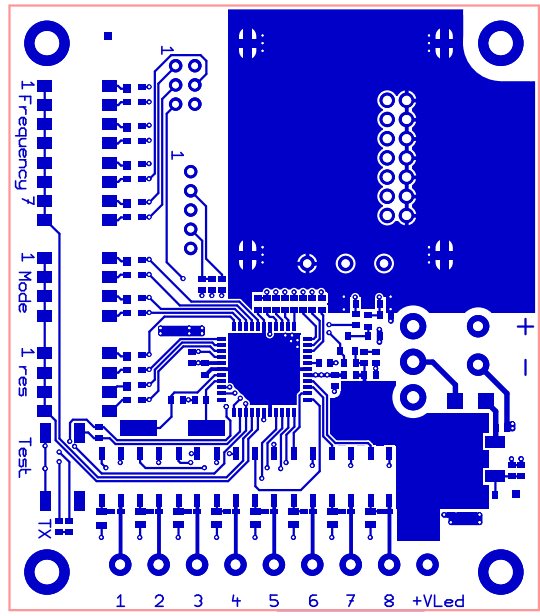

Zust.	Änderung	Datum	Name	Projekt:	Test-Board_CPD02-TX_02-a	
-00	Erstausgabe	24.10.06	RM	Seite:	PCB	
-01	Photocoupler, VReg updated	12.02.07	RM	Variante:	<alle>	
-02	L2, L3 single parts	29.03.07	RM			
-02a	R23 changed to 180R	16.04.07	RM			



Reimesch Kommunikationssysteme GmbH
 Friedrich-Ebert-Str. 1 D-51429 Bergisch Gladbach

Datei:	Test-Board_CPD02-TX_02-a.T3001	Blatt	1
Datum:	16.04.2007	100,00%	1 Bl.

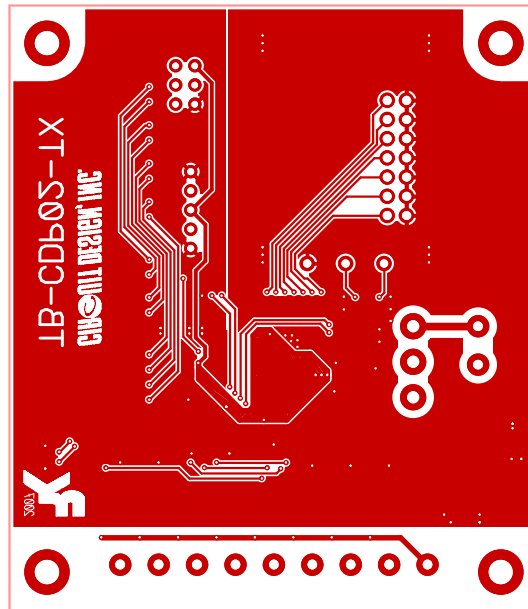

Zust.	Änderung	Datum	Name	Projekt:	Test-Board_CPD02-TX_02-a	
-00	Erstausgabe	24.10.06	RM	Seite:	PCB	
-01	Photocoupler, VReg updated	12.02.07	RM	Variante:	<alle>	
-02	L2, L3 single parts	29.03.07	RM			
-02a	R23 changed to 180R	16.04.07	RM			



Reimesch Kommunikationssysteme GmbH
 Friedrich-Ebert-Str. 1 D-51429 Bergisch Gladbach

Datei: Test-Board_CPD02-TX_02-a.T3001 Datum: 16.04.2007	Blatt 1 1 Bl.
--	------------------