

Fig. 4.

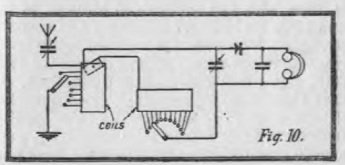

Fig. 10.

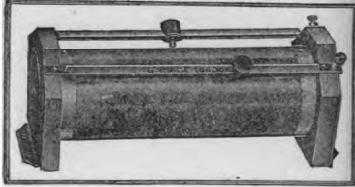

Fig. 5.

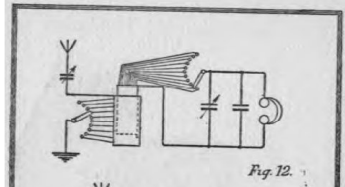

Fig. 12.

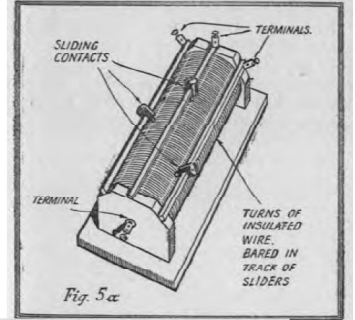

Fig. 5a

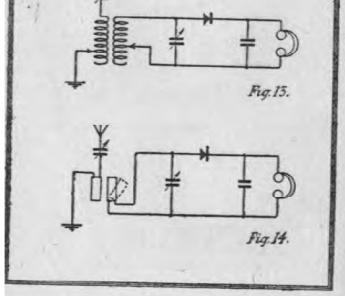

Fig. 15.



Fig. 14.

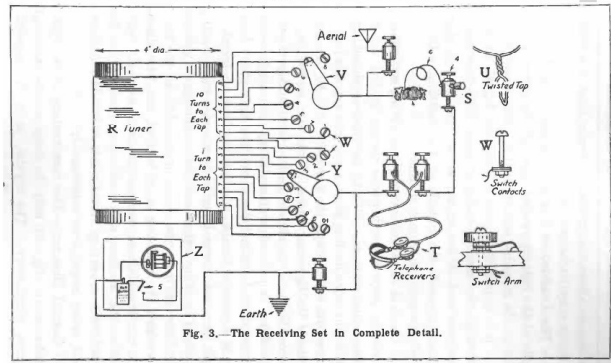
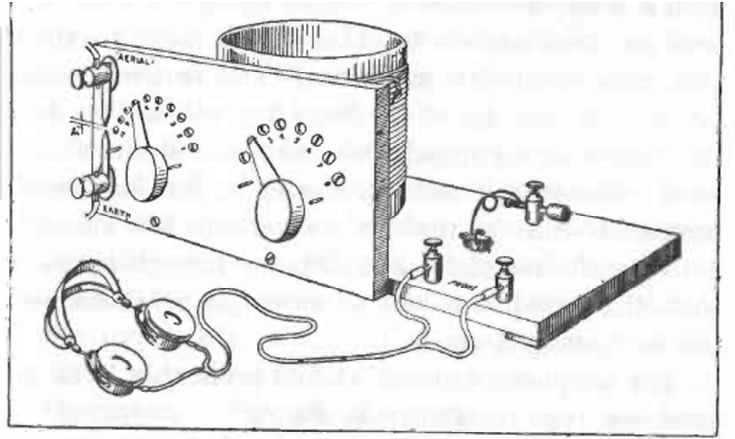

Fig. 3.—The Receiving Set in Complete Detail.

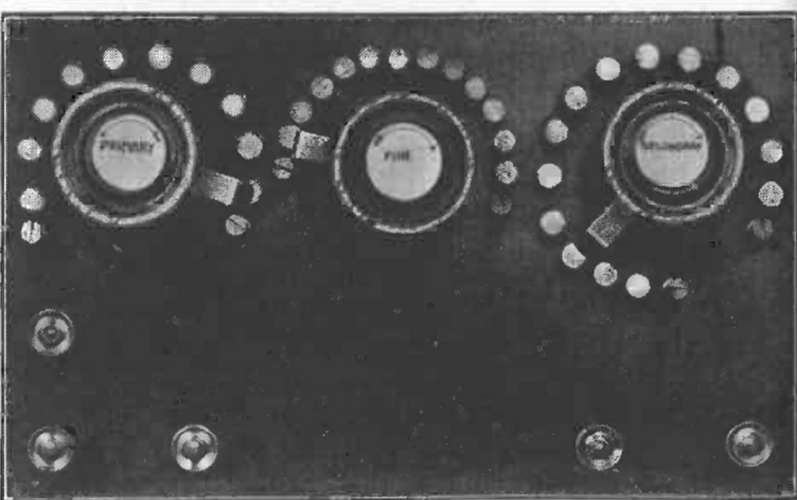
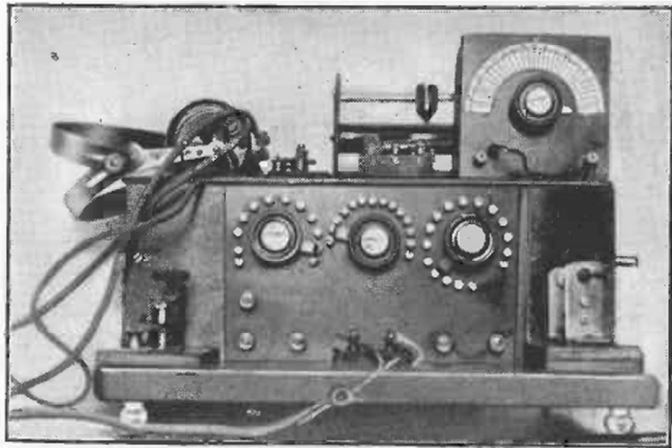
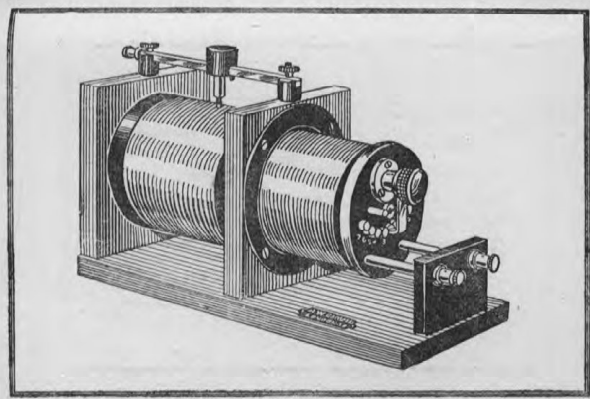

Fig. 34.—Photograph of Panel and Tuning Switches.

