



ELECTRONICS

Approval

TO :

DATE : September. 05. 2007

SAMSUNG TFT-LCD

MODEL NO. : LMS700KF05

Customer Approval

Any Modification of Spec is not allowed without SEC's permission.

Approved by : Se chun, Oh

AMLCD DIVISION

Samsung Electronics Co . , LTD.





Contents ELECTRONICS

Revision History	-----	(3)
General Description	-----	(4)
1. Absolute Maximum Ratings	-----	(6)
1.1 Absolute Ratings Of Environment		
1.2 Electrical Absolute Ratings		
2. Optical Characteristics	-----	(8)
3. Electrical Characteristics	-----	(13)
3.1 TFT-LCD Module		
3.2 Back-light Unit		
4. Block Diagram	-----	(15)
4.1 TFT-LCD Module with Back Light Unit		
4.2 Back Light Unit		
5. Input Terminal Pin Assignment	-----	(17)
5.1 Input Signal & Power		
5.2 Input Signal, Basic Display Colors and Gray Scale of Each Colors		
5.3 Pixel Format		
6. Interface Timing	-----	(20)
6.1 Vertical Timing		
6.2 Horizontal Timing		
6.3 Interface Timing		
6.4 AC Characteristic		
7. Power Up/Down Sequence	-----	(23)
7.1 Power up sequence		
7.2 Power up sequence		
8. Outline Dimension	-----	(25)
9. Packing	-----	(26)
10. Marking & Others	-----	(27)
11. General Precaution	-----	(28)
11.1 Handling		
11.2 Storage		
11.3 Operation		
11.4 Others		

Revision History

Approval

Data	Rev. No.	Page	Summary
Aug. 31. 2007	000		Rev.000 is first issued.

General Description

* Description

LMS700KF05 is a TMR(Transmissive with Micro Reflective) type color active matrix TFT (Thin Film Transistor) liquid crystal display (LCD) that uses amorphous silicon TFT as a switching devices. This model is composed of a TFT-LCD module, a driver circuit and a back-light unit. The resolution of a 7.0" contains 800 x 480(RGB) dots and can display up to 16.7M colors.

* Features

- Triple-Gate Technology applied
- Transmissive with Micro Reflective type and Back-light with LED is available.
- TN (Twisted Nematic) mode
- 24bit RGB Interface
- Back Light with 24 LEDs (Light Emitting Diode)

* Applications

- Display terminals for PMP(Portable Multimedia Player) , Portable CNS(P-CNS) , AV , UMPC (Ultra Mobile PC) application products.

*** General information**

Items	Specification	Unit	Note
Display area	152.4(H) x 91.44(V)	mm	-
Driver element	a-Si TFT active matrix	-	-
Display colors	16.7M	colors	-
Number of pixels	800(H) x 480 x RGB(V)	dot	-
Pixel arrangement	RGB stripe type (Horizontal)	-	-
Pixel pitch	0.1905(H) x 0.1905(V)	mm	-
Display mode	Normally white	-	-
Viewing direction	6	o'clock	-

*** Mechanical information**

Item		Min.	Typ.	Max.	Unit	Note
Module size	Horizontal(H)	162.9	163.2	163.5	mm	-
	Vertical(V)	103.7	104.0	104.3	mm	(1)
	Depth(D)	3.2	3.4	3.6	mm	(1)
Weight		-	105	-	g	-

Note (1) Not include FPC

Refer to the Outline Dimension in the "8.Outline Dimension" for further information.

1. Absolute Maximum Ratings

1.1 Absolute Ratings of Environment

Item	Symbol	Min.	Max.	Unit	Note
Storage temperature	T _{STG}	-30	70	°C	(1)
Operating temperature (Ambient temperature)	T _{OPR}	-20	60	°C	(1),(2)

Note (1) 90 % RH Max. (40 °C ≥ Ta)

Maximum wet-bulb temperature at 39 °C or less. (Ta > 40 °C) No condensation.

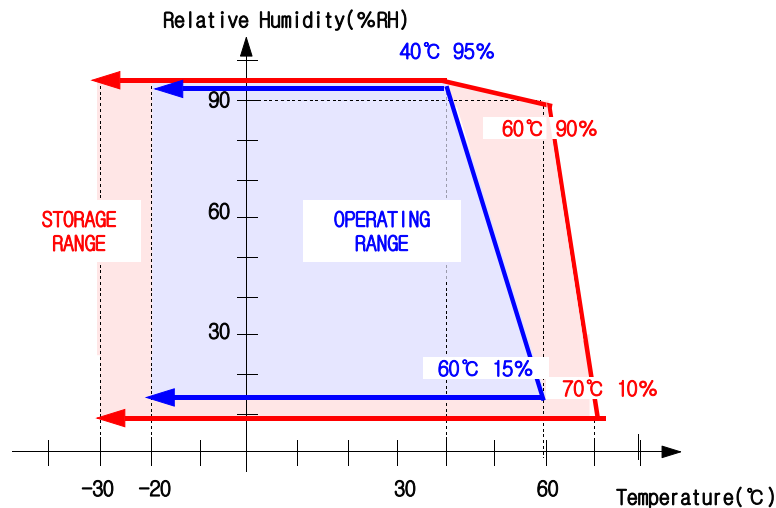

(2) In case of below 0°, the response time of liquid crystal (LC) becomes slower and the color of panel becomes darker than normal one.

Level of retardation depends on temperature, because of LC's characteristics.

(3) If any fixed pattern is displayed on LCD for minutes, image-sticking phenomenon may occur.

1.2 Electrical Absolute Ratings

(1) TFT-LCD Module

(Ta = 25°C, V_{SS}=GND=0V)

Characteristics	Symbol	Min.	Max.	Unit	Note
Power supply voltage	V _{CC}	-0.5	5.0	V	-

(2) Back-Light Unit

(Ta = 25 ± 2°C)

Item	Symbol	Min.	Max.	Unit.	Note
LED Current	I _L	-	30	mA	(1)

Note (1) Permanent damage to the device may occur if maximum values are exceeded or reverse voltage is loaded.

Functional operation should be restricted to the conditions described under normal operating conditions.

2. Optical Characteristics

The following items are measured under stable conditions. The optical characteristics should be measured in a dark room or equivalent state with the methods shown in Note (1).

Measuring equipment: SR-3, BM-7, EZ-Contrast

($T_a = 25 \pm 2^\circ\text{C}$, $V_{CC} = 3.3\text{V}$, $f_B = 60\text{Hz}$, $I_B = 20\text{mA}$)

Item	Symbol	Condition	Min.	Typ.	Max.	Unit	Note
Contrast ratio (Center point)	C/R	NOTE (1)	200	400	-	-	(2) SR-3
Luminance of white (Center point)	YL		280	350	-	cd/m ²	(3) SR-3
Response time	Rising:Tr Falling:Tf		$\phi = 0$ $\theta = 0$	-	25.0	50	msec
Color chromaticity (CIE 1931)	White	Wx	0.266	0.316	0.366	-	(6) SR-3
		Wy	0.285	0.335	0.385		
	Red	Rx	0.507	0.607	0.607		
		Ry	0.321	0.371	0.421		
	Green	Gx	0.295	0.345	0.395		
		Gy	0.521	0.571	0.621		
	Blue	Bx	0.099	0.149	0.199		
		By	0.064	0.114	0.164		
Viewing angle	Hor.	θ_L	55	65	-	Degrees	(7) Ez-Contrast
		θ_R	55	65	-		
	Ver.	ϕ_H	40	50	-		
		ϕ_L	50	60	-		
Brightness Uniformity (9 point)	B _{uni}		70	80	-	-	(4) SR-3
Crosstalk			-	-	5	%	(8) SR-3

Note (1) Test Equipment Setup

After stabilizing and leaving the panel alone at a given temperature for 30 min , the measurement should be executed. Measurement should be executed in a stable, windless, and dark room. 30 min after lighting the back-light. This should be measured in the center of screen.

Environment condition : $T_a = 25 \pm 2 \text{ }^\circ\text{C}$

Back-Light On condition

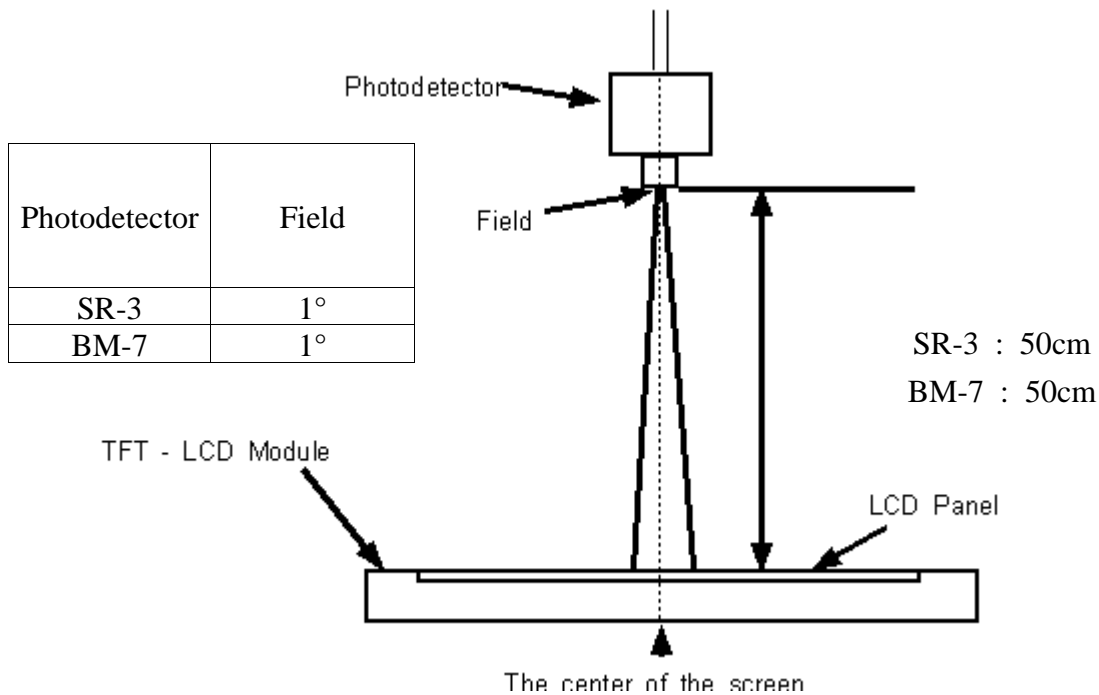

Note (2) Definition of Contrast Ratio (C/R) : Ratio of gray max (Gmax) & gray min (Gmin) at the center point

$$CR = \frac{G_{\max}}{G_{\min}}$$

* Gmax : Luminance with all pixels white

* Gmin : Luminance with all pixels black

Note (3) Definition of Luminance of White : Luminance of white at the center point

Note (4) Definition of White Uniformity :

$$\text{White Uniformity} = \frac{\text{Min luminance of white among 9-points}}{\text{Max luminance of white among 9-points}} \times 100$$

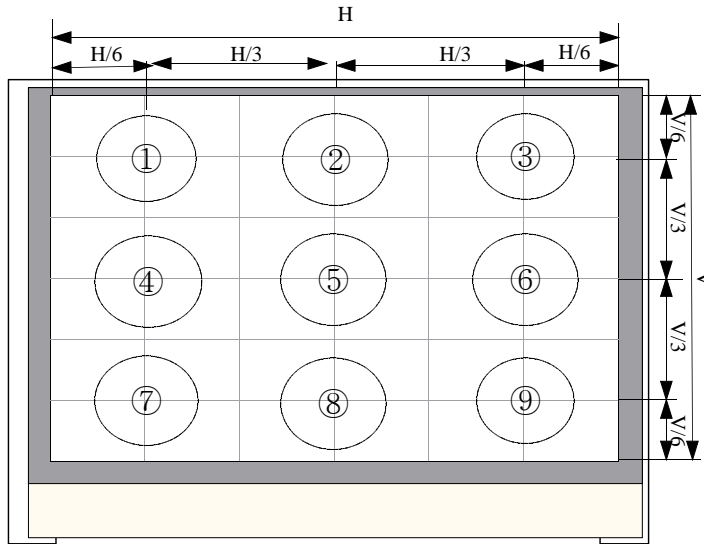

Note (5) Definition of Response time : Sum of T_r , T_f

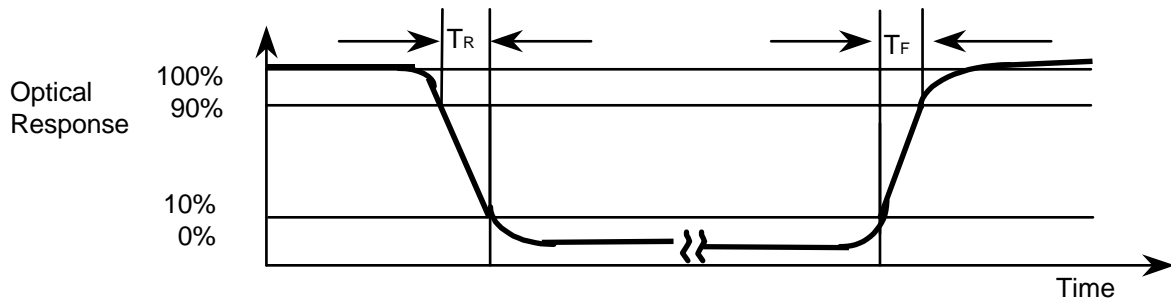
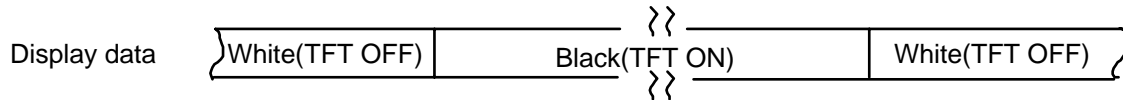

Note (6) Definition of Color Chromaticity (CIE 1931)

Color coordinate of white & red, green, blue at center point.

Note (7) Definition of Viewing Angle : Viewing angle range ($CR \geq 10$)

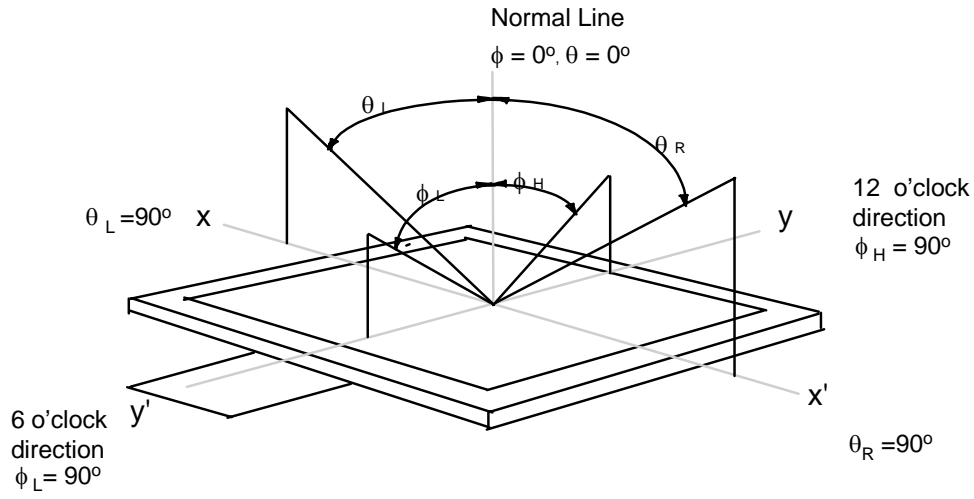

Note (8) Crosstalk

$$\text{Crosstalk Modulation Ratio}(D_{SHA}) = \frac{|Y_A - Y_B|}{Y_A} \times 100 (\%)$$

Where

Y_A, Y_B measurement = 2° Viewing Angle (Measurement area $\varphi 12\text{mm}$)

The pattern except the Black Bar is a gray 127.

Ⓐ Horizontal-Crosstalk measurement method

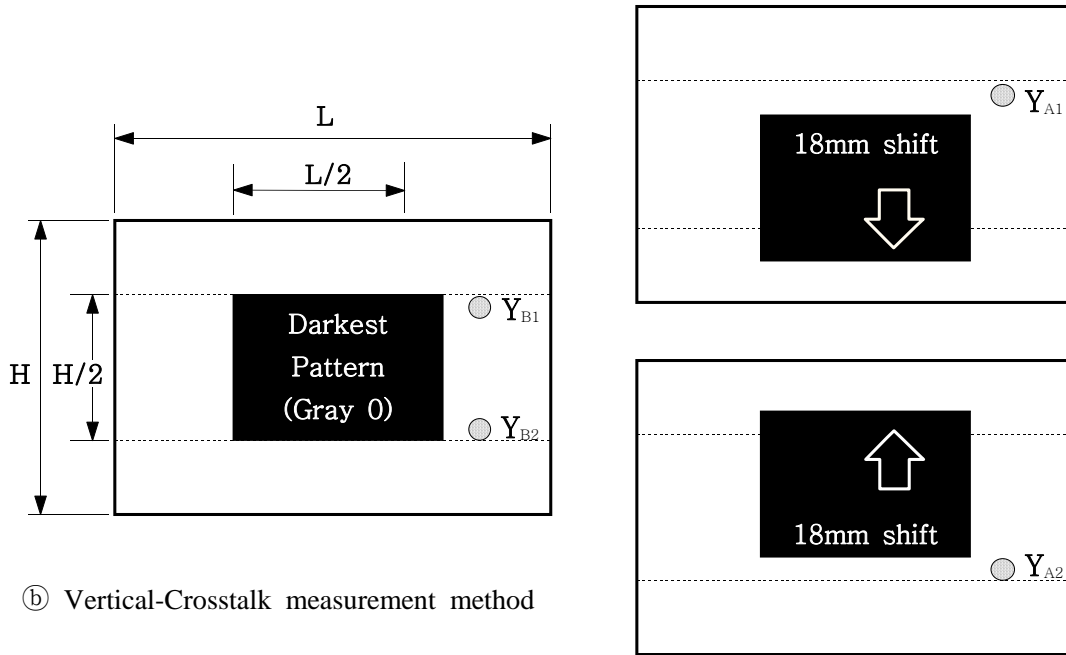

Ⓑ Vertical-Crosstalk measurement method

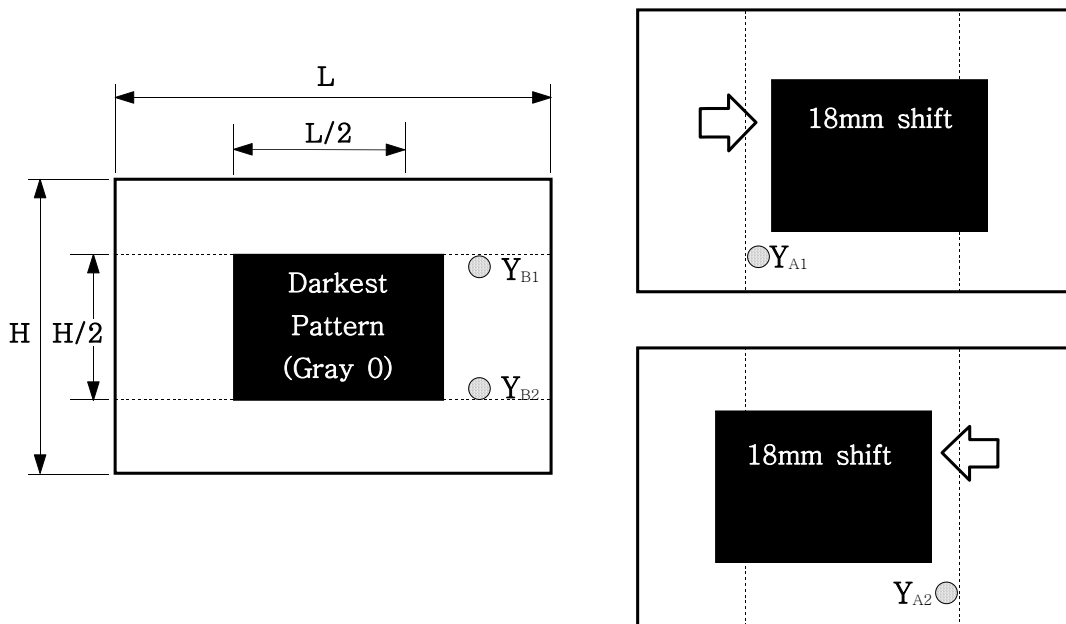

3. Electrical Characteristics

3.1 TFT-LCD Module

 $T_a = 25 \pm 2^\circ\text{C}$

Characteristics	Symbol	Min.	Typ.	Max.	Unit	Note
Power supply voltage	V_{CC}	3.0	3.3	3.6	V	-
Power Dissipation	White	-	300	390	mW	(1),(2)
	Black	-	300	390		
	1 DOT	-	450	590		
Frame frequency	f_{Frame}	55	60	-	Hz	-
Dot Clock	DOTCLK	-	24.5	-	MHz	-

* To prevent a latch-up or DC operation of the LCD module, the power on/off sequence should be as the Chapter 7. Power Up/Down Sequence.

Note (1) $V_{CC} = 3.3\text{V}$, $f_{\text{Frame}} = 60\text{Hz}$, $\text{DOTCLK} = 24.5\text{MHz}$
 (2) Dissipation current check pattern

► White pattern

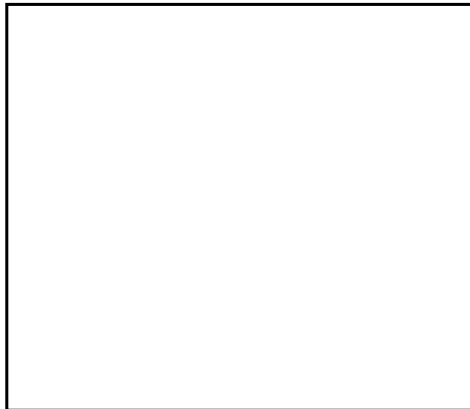

► Black pattern

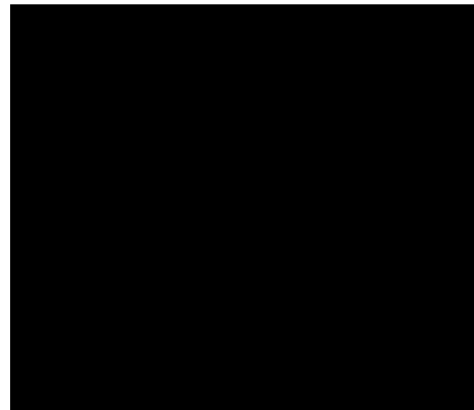

► 1 Dot pattern

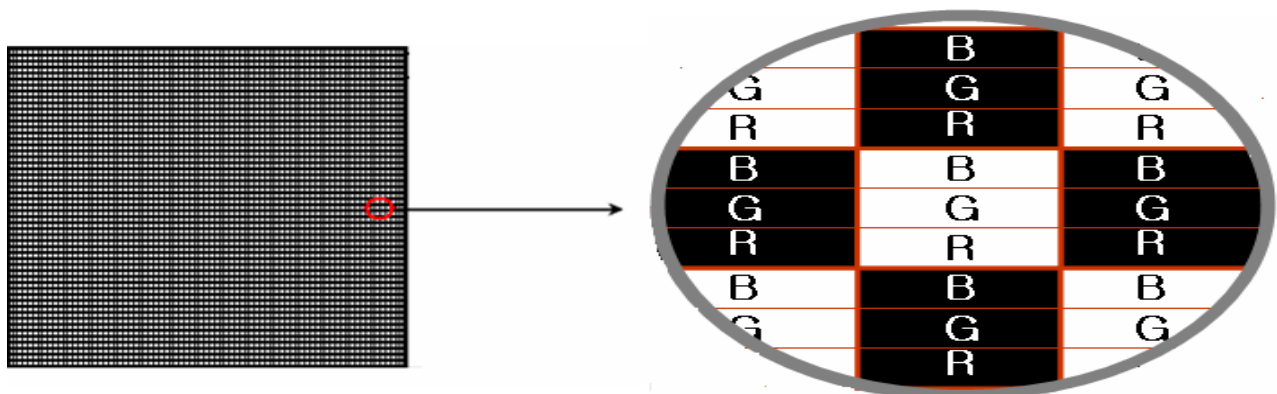

3.2 Back-Light unit

The Back Light system is an edge-lighting type with 24 white LED (Light Emitting Diode)s.

($T_a=25 \pm 2^\circ\text{C}$)

Item	Symbol	Min.	Typ.	Max.	Unit	Note
LEDs Current	I_B	15	20	25	mA	(1)
Power Consumption	P_{BL}	1.2	1.6	2.0	W	-

Note (1) The LEDs parallel type (Refer to 4.2)

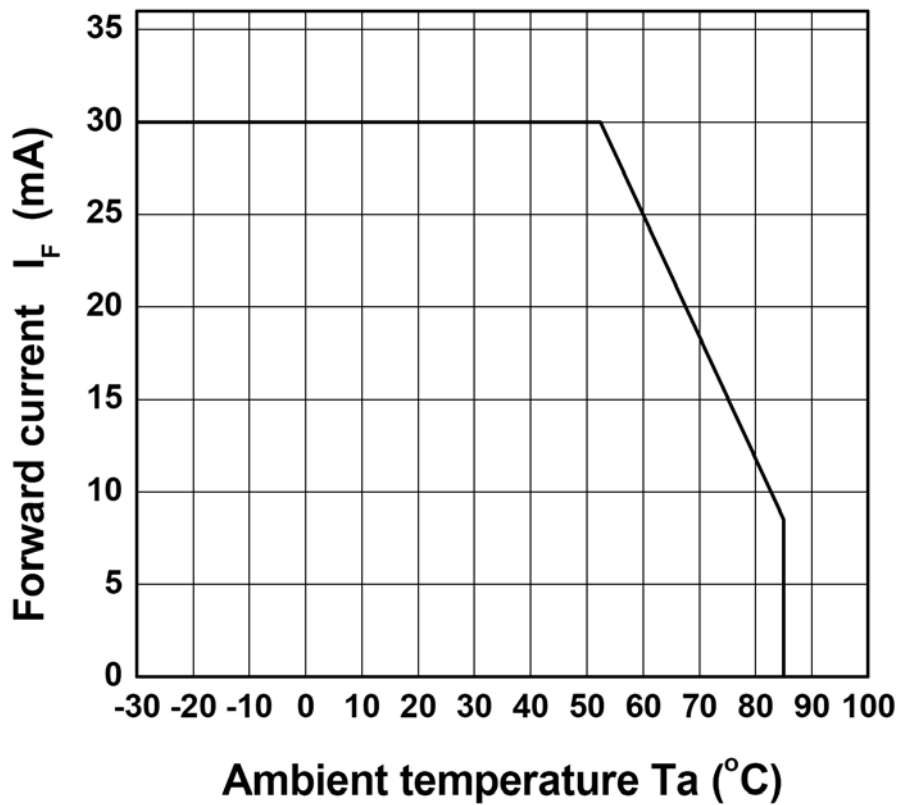

4. Block Diagram

4.1 TFT-LCD Module (Interface System Structure) with Back Light Unit

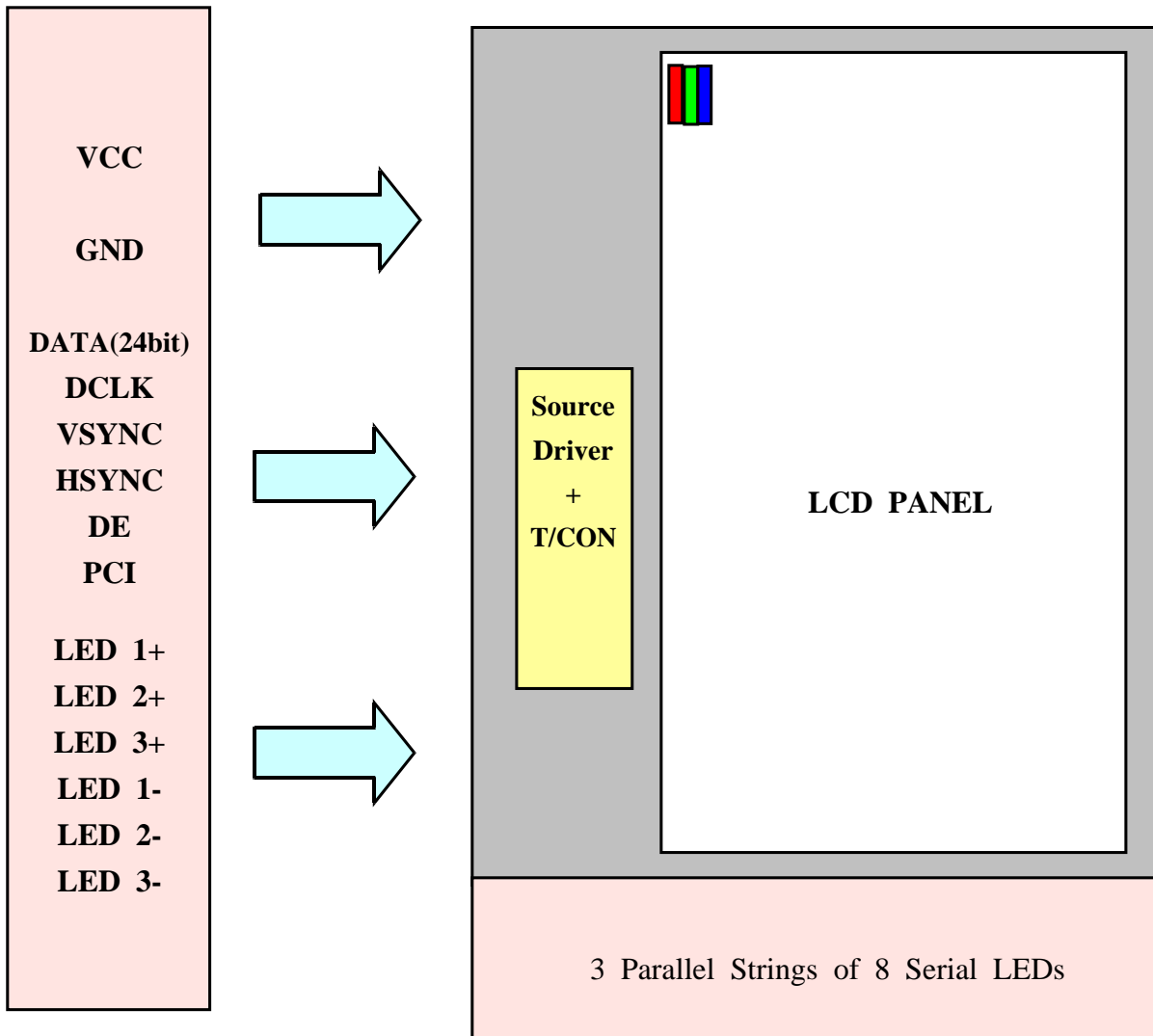

4.2 Back Light Unit

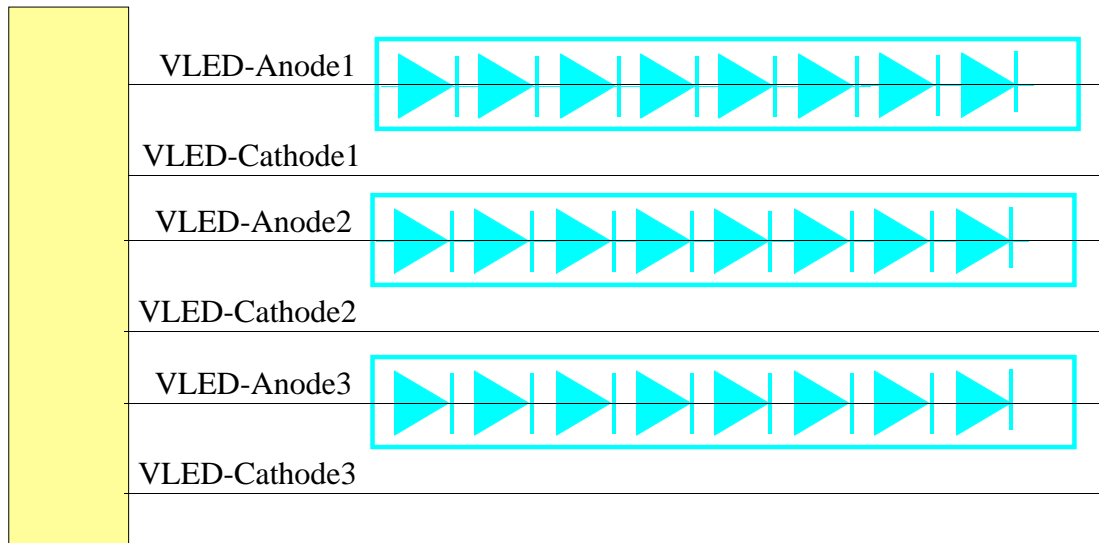

Pin No.	Pin Description
#1	VLED-Anode1
#2	VLED-Cathode1
#3	VLED-Anode2
#4	VLED-Cathode2
#5	VLED-Anode3
#6	VLED-Cathode3

* Note) LED FPC Connector : 04-6298-006-000-883 (Kyocera) or compatible connector is preferred

5. Input Terminal Pin Assignment

5.1 Input Signal & Power (Connector : 40Pin FPC Connector type, 0.5mm,
ex.) Hirose connector FH28H-40S-0.5SH or compatible Connector used.)

Pin No	Symbol	Description	I/O	Pin No	Symbol	Description	I/O
1	GND	GND	I	21	PD0	Graphic Data 0 (B0)	I
2	GND	GND	I	22	PD1	Graphic Data 1 (B1)	I
3	Vcc	System Power Supply	I	23	PD2	Graphic Data 2 (B2)	I
4	Vcc	System Power Supply	I	24	PD3	Graphic Data 3 (B3)	I
5	PD16	Graphic Data 16 (R0)	I	25	PD4	Graphic Data 4 (B4)	I
6	PD17	Graphic Data 17 (R1)	I	26	PD5	Graphic Data 5 (B5)	I
7	PD18	Graphic Data 18 (R2)	I	27	PD6	Graphic Data 6 (B6)	I
8	PD19	Graphic Data 19 (R3)	I	28	PD7	Graphic Data 7 (B7)	I
9	PD20	Graphic Data 20 (R4)	I	29	GND	GND	I
10	PD21	Graphic Data 21 (R5)	I	30	DOTCLK	DOT CLOCK	I
11	PD22	Graphic Data 22 (R6)	I	31	PCI	Display Mode *Note	I
12	PD23	Graphic Data 23 (R7)	I	32	HSYNC	HSYNC	I
13	PD8	Graphic Data 8 (G0)	I	33	VSYNC	VSYNC	I
14	PD9	Graphic Data 9 (G1)	I	34	DE	Data Enabling Signal	I
15	PD10	Graphic Data 10 (G2)	I	35	NC	No Connect	-
16	PD11	Graphic Data 11 (G3)	I	36	NC	No Connect	-
17	PD12	Graphic Data 12 (G4)	I	37	GND	GND	I
18	PD13	Graphic Data 13 (G5)	I	38	GND	GND	I
19	PD14	Graphic Data 14 (G6)	I	39	NC	No Connect	-
20	PD15	Graphic Data 15 (G7)	I	40	NC	No Connect	-

*** Note** : Regarding to the PCI, Please refer to the Power up/down sequence

5.2 Input Signal, Basic Display Colors and Gray Scale of Each Colors

COLOR	DISPLAY	DATA SIGNAL																				GRAY SCALE LEVEL				
		RED							GREEN							BLUE										
		R0	R1	R2	R3	R4	R5	R6	R7	G0	G1	G2	G3	G4	G5	G6	G7	B0	B1	B2	B3		B4	B5	B6	B7
BASIC COLOR	BLACK	0	0	0	0	0	0	0	0	0	0	0	0	0	0	0	0	0	0	0	0	0	0	0	0	-
	BLUE	0	0	0	0	0	0	0	0	0	0	0	0	0	0	0	0	1	1	1	1	1	1	1	1	-
	GREEN	0	0	0	0	0	0	0	0	1	1	1	1	1	1	1	1	0	0	0	0	0	0	0	0	-
	CYAN	0	0	0	0	0	0	0	0	1	1	1	1	1	1	1	1	1	1	1	1	1	1	1	1	-
	RED	1	1	1	1	1	1	1	1	0	0	0	0	0	0	0	0	0	0	0	0	0	0	0	0	-
	MAGENTA	1	1	1	1	1	1	1	1	0	0	0	0	0	0	0	0	1	1	1	1	1	1	1	1	-
	YELLOW	1	1	1	1	1	1	1	1	1	1	1	1	1	1	1	1	0	0	0	0	0	0	0	0	-
	WHITE	1	1	1	1	1	1	1	1	1	1	1	1	1	1	1	1	1	1	1	1	1	1	1	1	-
GRAY SCALE OF RED	BLACK	0	0	0	0	0	0	0	0	0	0	0	0	0	0	0	0	0	0	0	0	0	0	0	R0	
	DARK ↑	R1	1	0	0	0	0	0	0	0	0	0	0	0	0	0	0	0	0	0	0	0	0	0	0	R1
		R2	0	1	0	0	0	0	0	0	0	0	0	0	0	0	0	0	0	0	0	0	0	0	0	R2
		: :	: :	: :	: :	: :	: :	: :	: :	: :	: :	: :	: :	: :	: :	: :	: :	: :	: :	: :	: :	: :	: :	: :	: :	R3~R252
		↓ LIGHT	1	0	1	1	1	1	1	1	0	0	0	0	0	0	0	0	0	0	0	0	0	0	0	
	R254	0	1	1	1	1	1	1	1	0	0	0	0	0	0	0	0	0	0	0	0	0	0	0	R254	
	RED	1	1	1	1	1	1	1	1	0	0	0	0	0	0	0	0	0	0	0	0	0	0	0	R255	
	GRAY SCALE OF GREEN	BLACK	0	0	0	0	0	0	0	0	0	0	0	0	0	0	0	0	0	0	0	0	0	0	0	G0
DARK ↑		G1	0	0	0	0	0	0	0	0	1	0	0	0	0	0	0	0	0	0	0	0	0	0	0	G1
		G2	0	0	0	0	0	0	0	0	0	1	0	0	0	0	0	0	0	0	0	0	0	0	0	G2
		: :	: :	: :	: :	: :	: :	: :	: :	: :	: :	: :	: :	: :	: :	: :	: :	: :	: :	: :	: :	: :	: :	: :	: :	G3~G252
		↓ LIGHT	0	0	0	0	0	0	0	0	1	0	1	1	1	1	1	1	0	0	0	0	0	0	0	
G254		0	0	0	0	0	0	0	0	0	1	1	1	1	1	1	1	0	0	0	0	0	0	0	G254	
GREEN		0	0	0	0	0	0	0	0	1	1	1	1	1	1	1	1	0	0	0	0	0	0	0	G255	
GRAY SCALE OF BLUE		BLACK	0	0	0	0	0	0	0	0	0	0	0	0	0	0	0	0	0	0	0	0	0	0	0	B0
	DARK ↑	B1	0	0	0	0	0	0	0	0	0	0	0	0	0	0	0	1	0	0	0	0	0	0	0	B1
		B2	0	0	0	0	0	0	0	0	0	0	0	0	0	0	0	0	1	0	0	0	0	0	0	B2
		: :	: :	: :	: :	: :	: :	: :	: :	: :	: :	: :	: :	: :	: :	: :	: :	: :	: :	: :	: :	: :	: :	: :	: :	B3~B252
		↓ LIGHT	0	0	0	0	0	0	0	0	0	0	0	0	0	0	0	0	1	0	1	1	1	1	1	
	B254	0	0	0	0	0	0	0	0	0	0	0	0	0	0	0	0	0	1	1	1	1	1	1	B254	
	BLUE	0	0	0	0	0	0	0	0	0	0	0	0	0	0	0	0	1	1	1	1	1	1	1	B255	

Note) Definition of Gray :

Rn : Red Gray, Gn : Green Gray, Bn : Blue Gray (n = Gray level)

Input Signal : 0 = Low level voltage, 1 = High level voltage

5.3 Pixel Format

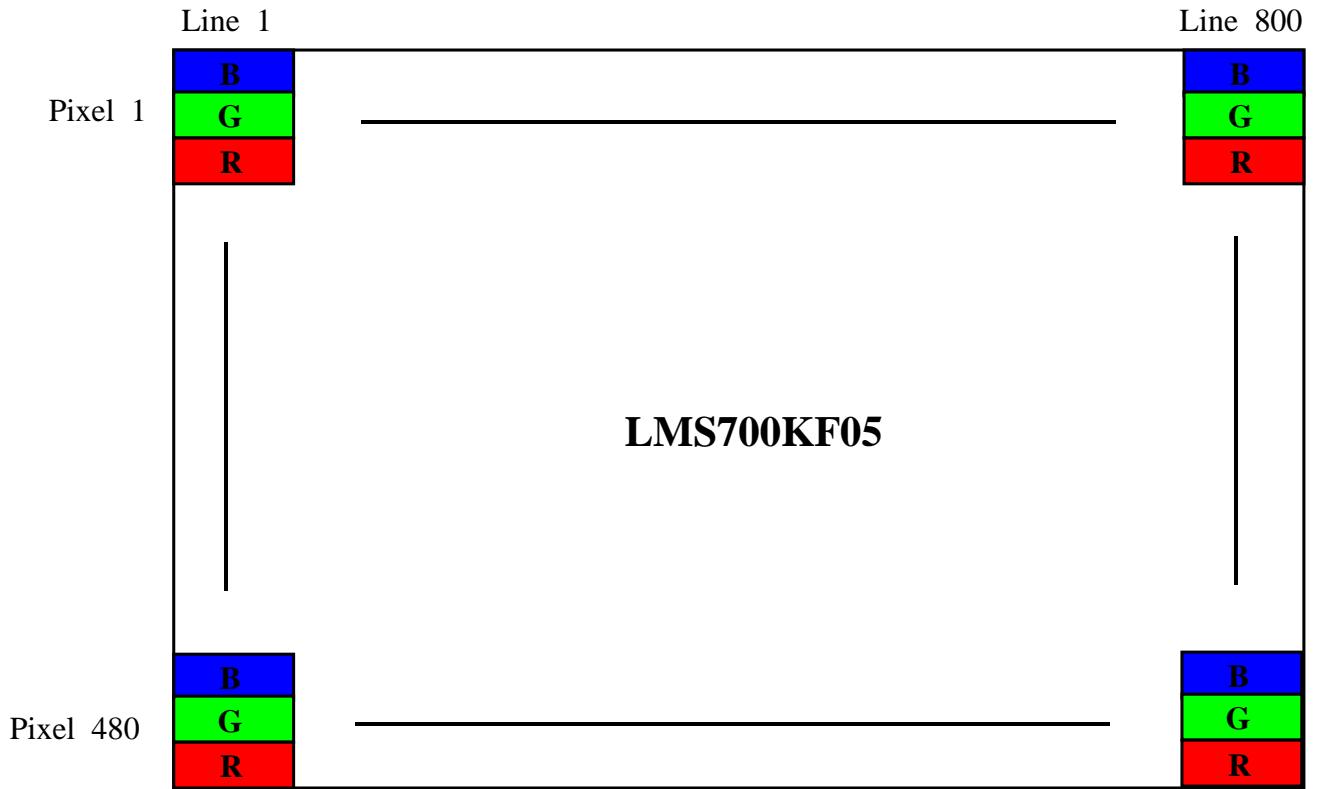

6. INTERFACE TIMING

6-1. Vertical timing

Signal	Symbol	Min.	Typ.	Max.	Unit	Note
Frame Frequency	fFRM	-	60	-	Hz	
Vertical Back porch	VBP	-	8	-	H	*Note
Vertical Front porch	VFP	-	5	-	H	*Note

6-2. Horizontal timing

Signal	Symbol	Min.	Typ.	Max.	Unit	Note
Horizontal Back porch	HBP	-	16	-	DOTCLK	*Note
Horizontal Front porch	HFP	-	8	-	DOTCLK	*Note
DOTCLK Frequency	f _{DOTCLK}	-	24.5	-	MHz	@fFRM=60Hz

*Note). VBP, VFP, HBP, HFP are fixed, set those timing data as the above data.

6.3 Interface Timing

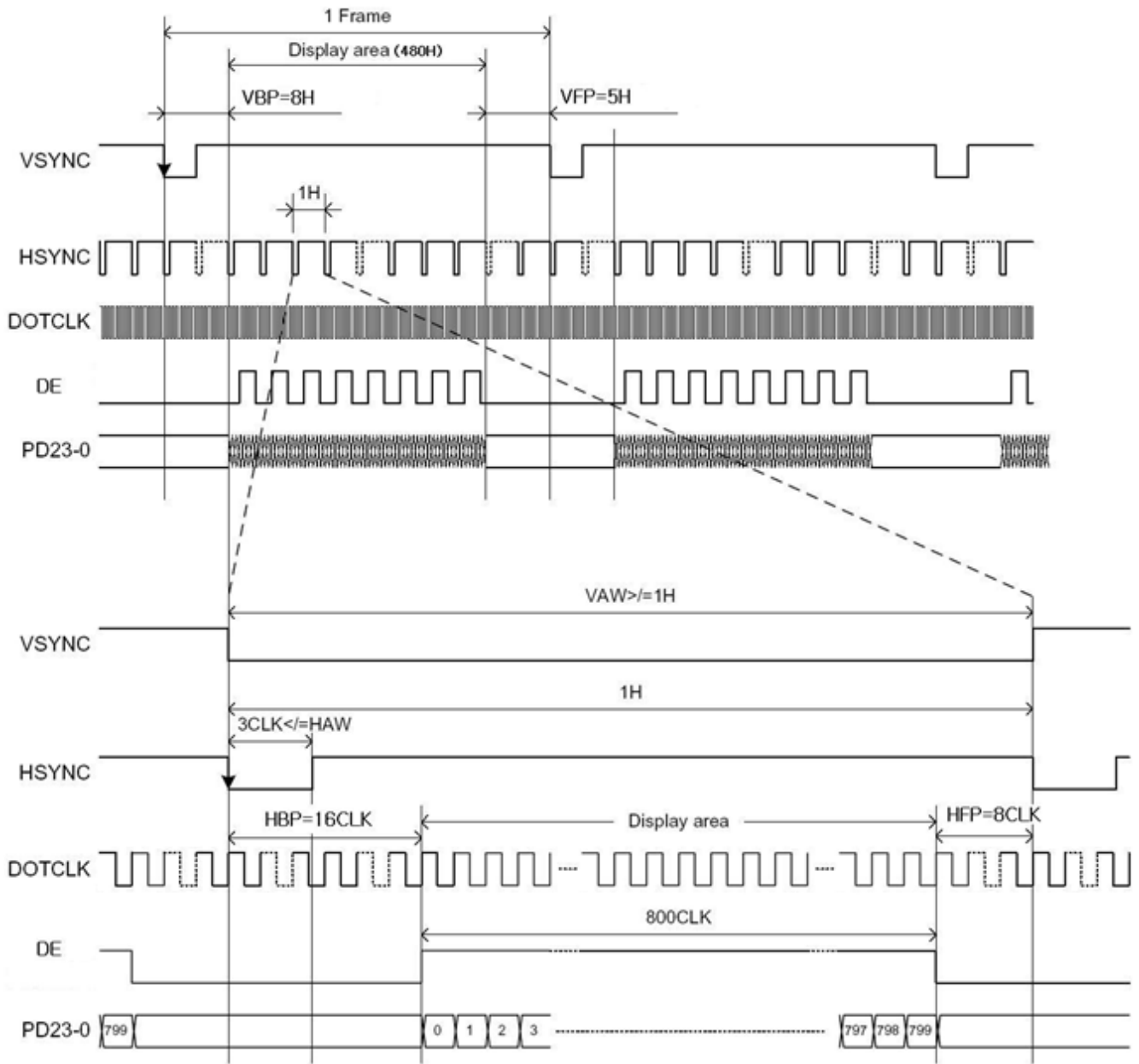

6.4 AC Characteristic

(Ta=-20 to +60 °C)

Parameter	Symbol	Min.	Typ.	Max.	Unit
VSYNC setup time	tVSS	5	-	-	ns
VSYNC hold time	tVSH	5	-	-	
HSYNC setup time	tHSS	5	-	-	
HSYNC hold time	tHSH	5	-	-	
DOTCLK cycle time	tDCYC	28	-	-	
DOTCLK rise/fall time	tR,tF		-	2	
DOTCLK Pulse width high	tDCHW	8	-	-	
DOTCLK Pulse width low	tDCLW	8	-	-	
DE setup time	tENS	5	-	-	
DE hold time	tENH	5	-	-	
PD data setup time	tPDS	5	-	-	
PD data hold time	tPDH	5	-	-	

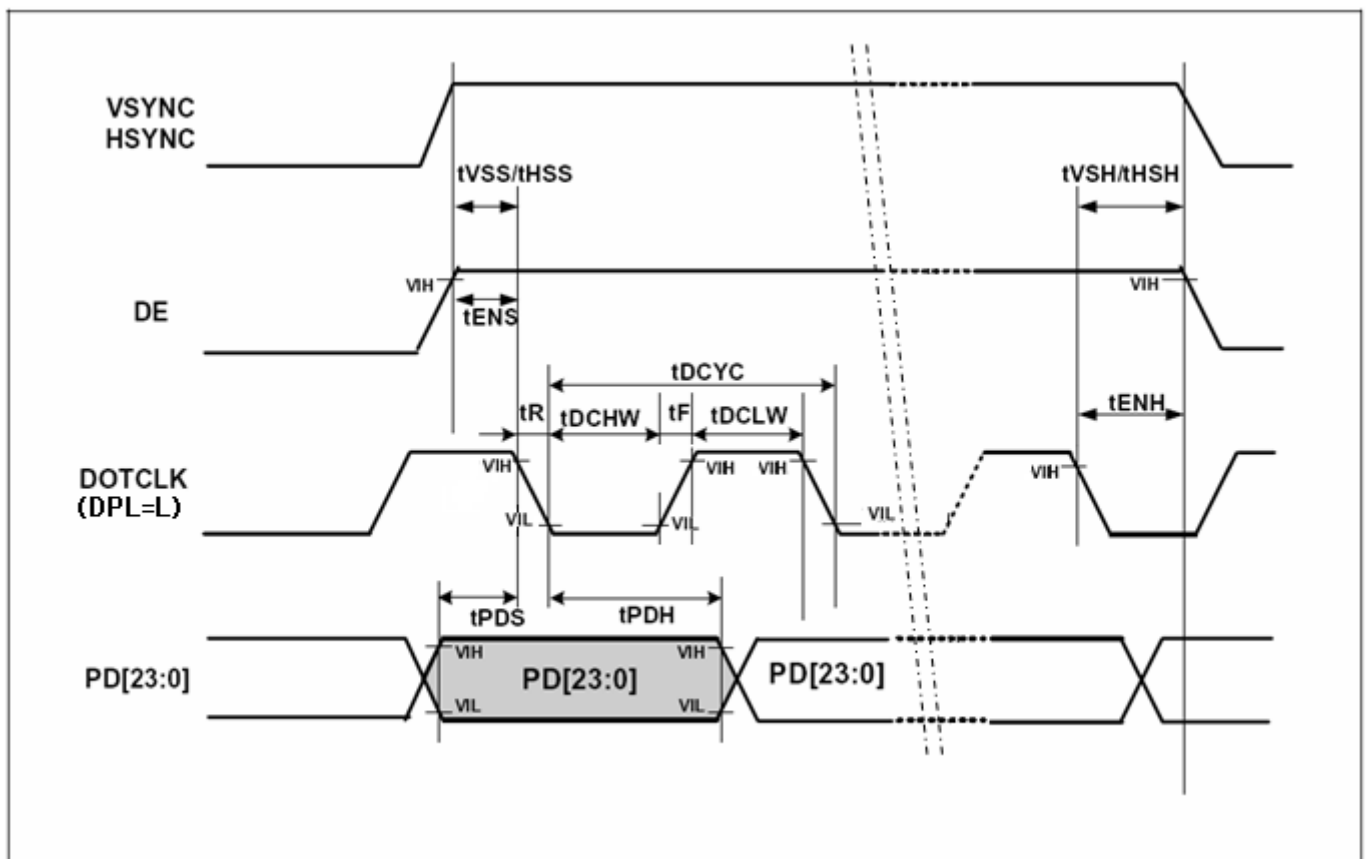

7. Power Up/Down sequence

7.1 Power up sequence.

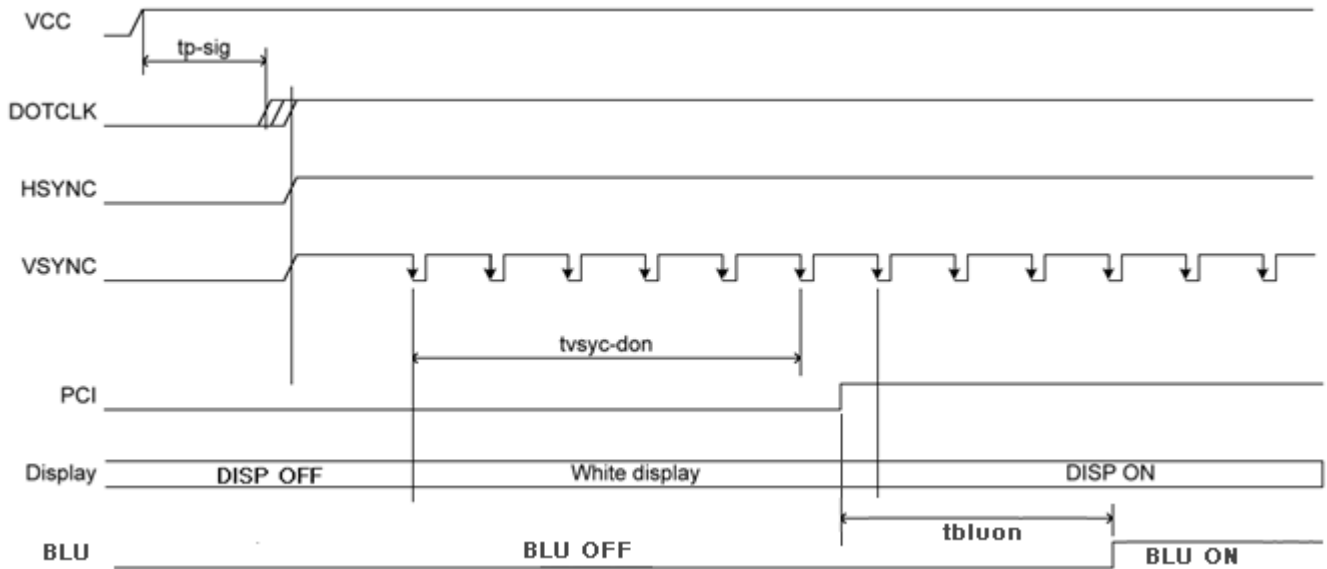

Characteristics		MIN	TYP	MAX	Unit
VCC on to Signal input	t_{p-sig}	10			mS
Waiting time to DISP ON from 1st VSYNC	$t_{vsync-don}$	16.7			mS
		1			Frame
BLU On Time (Duration time after PCI gets high)	t_{bluon}	50			mS

Note) From the 1st Vsync after PCI set high, it starts display on.

7.2 Power down sequence.

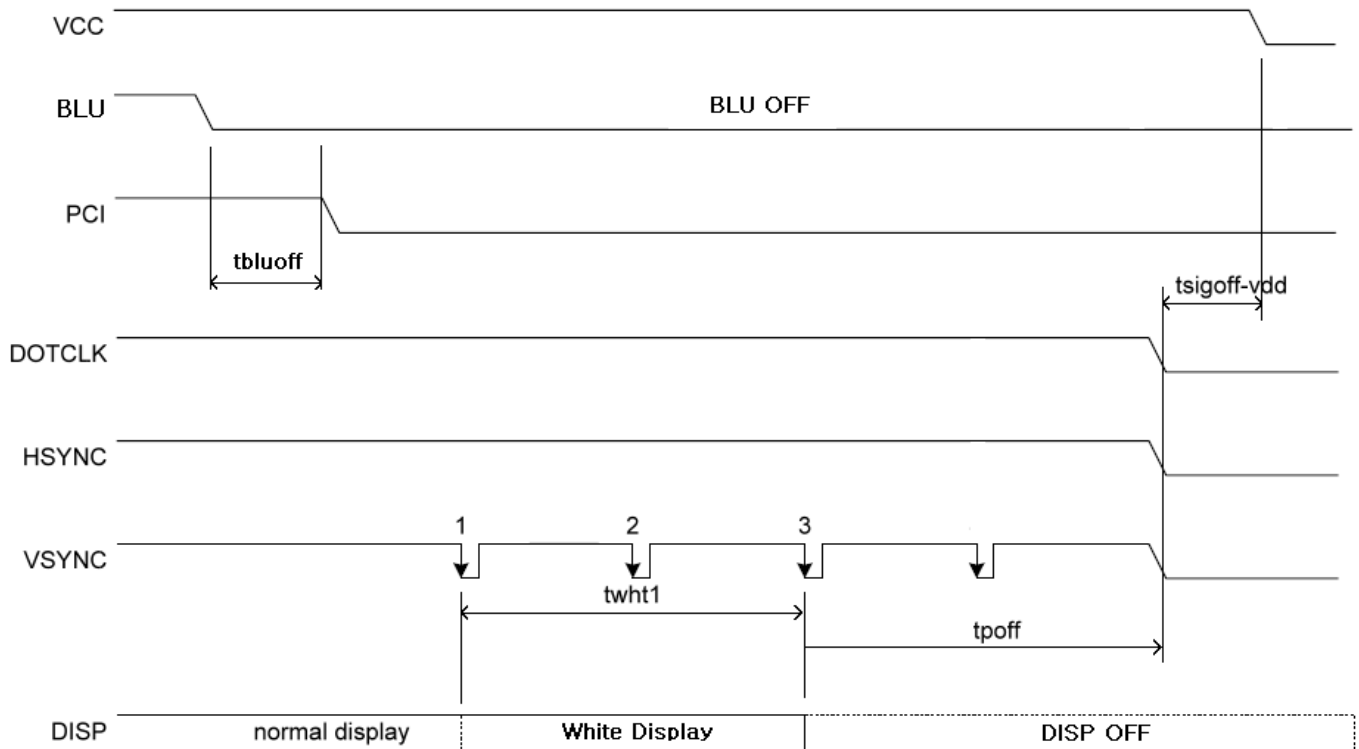

Characteristics		MIN	TYP	MAX	Unit
BLU Off Time (Duration time before PCI gets low)	t_{bluoff}	50			mS
White Display Time (from 1st Vsync at PCI=L)	$twht1$	33.3			mS
		2			Frame
DISP OFF Time (from 3rd Vsync at PCI=L)	$tpoff$	16.7			mS
		1			Frame
Input-signal off to VCC Off	$t_{sigoff-vdd}$	10			mS

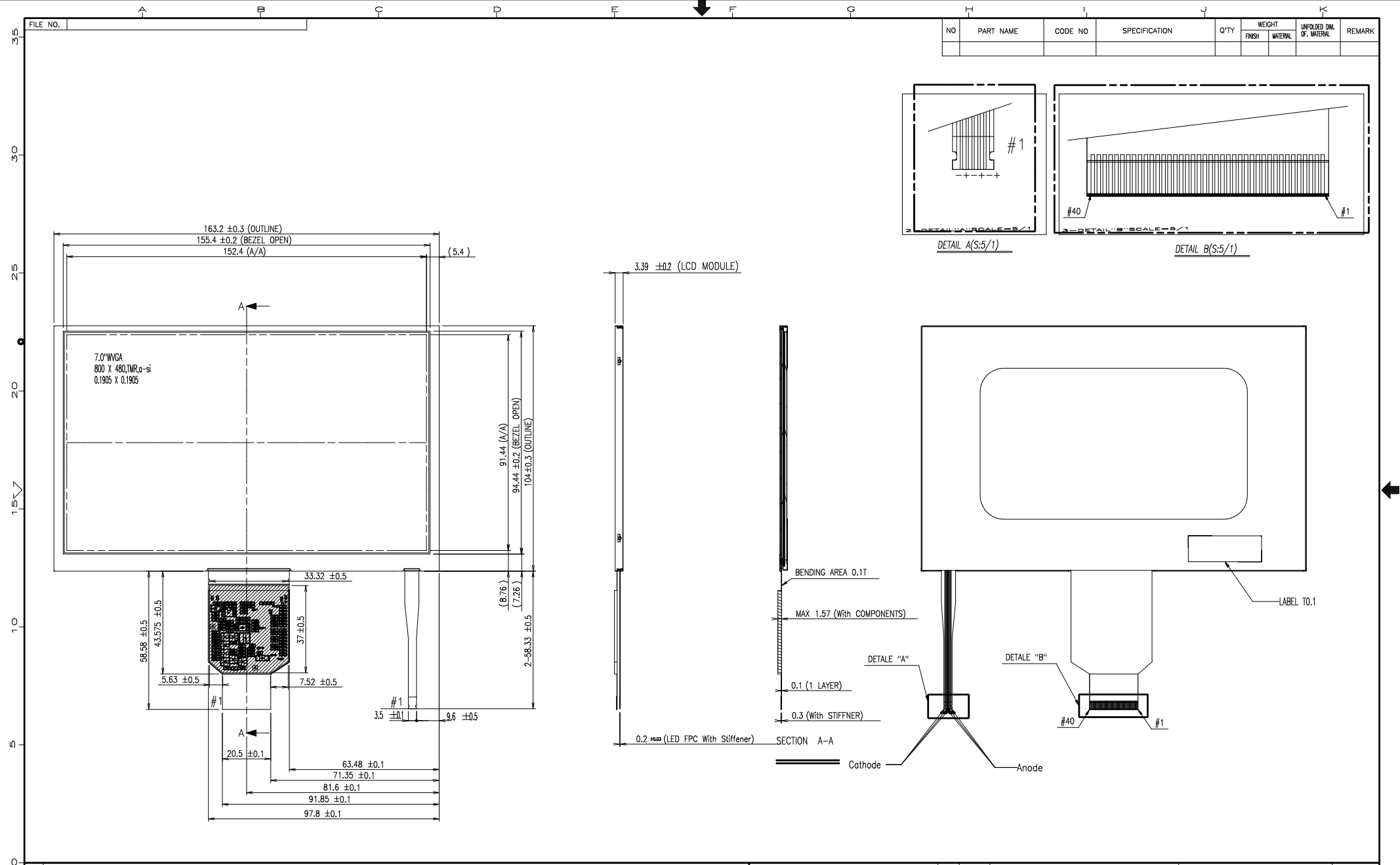

NO	PART NAME	CODE NO	SPECIFICATION	Q'TY	WEIGHT FINISH MATERIAL	UNFOLDED DIM. OF MATERIAL	REMARK

REVIS
NOTS

GENERAL TOLERANCE				REV	DATE	DESCRIPTION OF REVISION			REASON		CHK'D BY
STEP	LEVEL 1	LEVEL 2	LEVEL 3	UNIT	mm	DRA'N BY	DES'D BY	CHK'D BY	APP'D BY	MODEL NAME	
0 < X ≤ 4	±0.05	±0.1	±0.2	SCALE	1/1	Y.H.KIM	I.S.LEE	Y.B.CHU		LMS700KF05	
4 < X ≤ 16	±0.08	±0.15	±0.3	TOLERANCE						PART/SHEET NAME	OUTLINE DIMENSION
16 < X ≤ 64	±0.12	±0.25	±0.5	LEVEL 3		07.08.31	07.08.31	07.08.31		SHEET	1/1
64 < X ≤ 256	±0.25	±0.4	±0.8	SPEC. NO						CODE NO.	
SAMSUNG ELECTRONICS											VER. 000

9. Packing

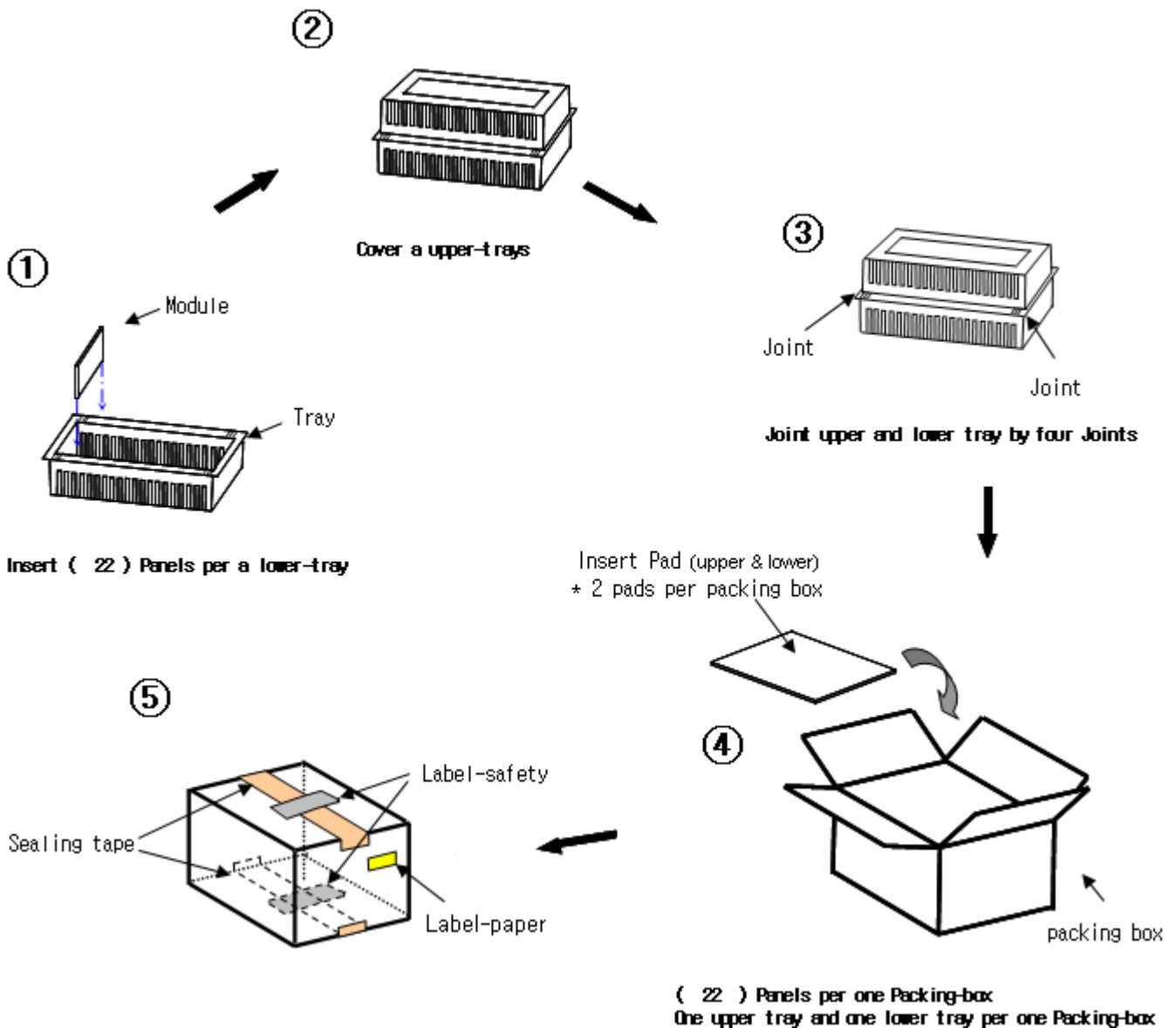

Note

- (1) Total : Packing box : Approx. 2.84kg
- (2) Size :355(W) x 250(D) x 156(H)
- (3) Place the panels in the tray facing the direction shown in the figure.
- (4) Place lower tray and cover upper tray and pads inside the packing-box.
- (5) Seal the packing-box. Affix the label-safety.

10. Marking & Others

A nameplate bearing followed by is affixed to a shipped product at the Specified location on each product.

(1) Module attach

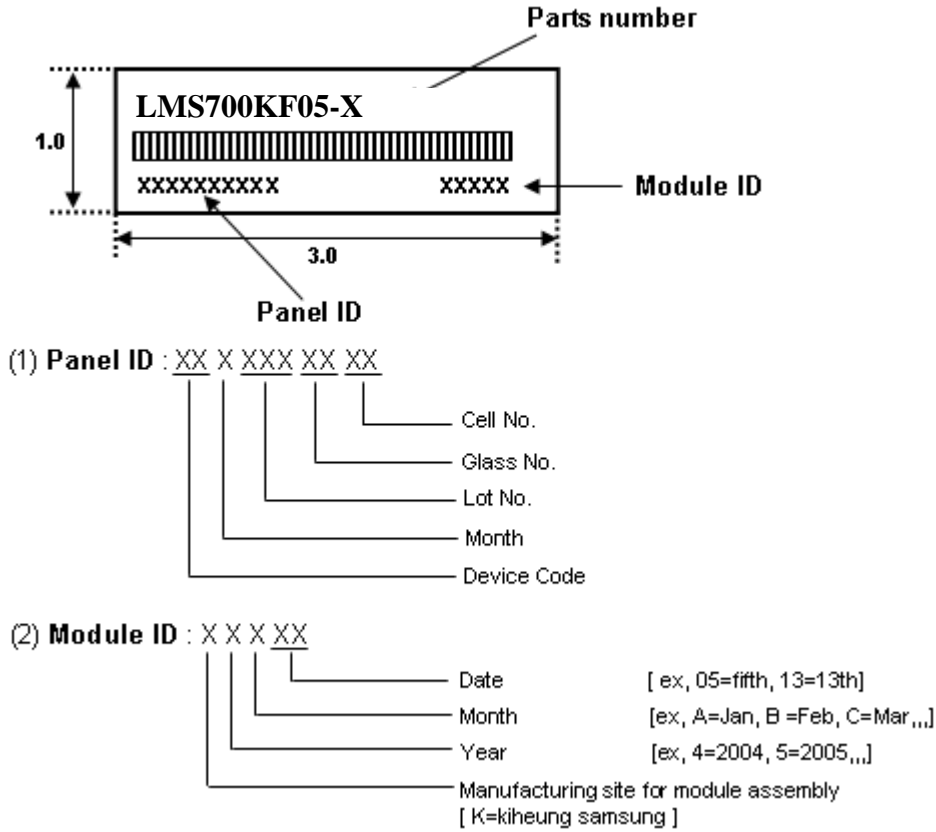

(2) Packing Case attach

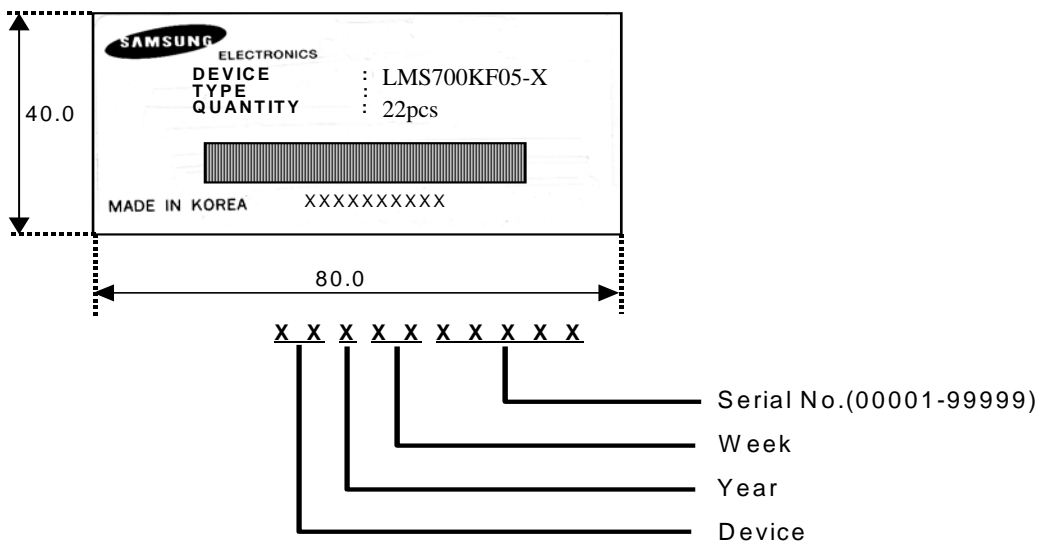

11. General Precautions

11.1 Handling

- (a) When the module is assembled, it should be attached to the system firmly. Be careful not to twist and bend the module.
- (b) Refrain from strong mechanical shock and / or any force to the module. In addition to damage, this may cause improper operation or damage to the module and back-light unit.
- (c) Note that polarizers are very fragile and could be easily damaged. Do not press or scratch the surface harder than a HB pencil lead.
- (d) Wipe off water droplets or oil immediately. If you leave the droplets for a long time, Staining and discoloration may occur.
- (e) If the surface of the polarizer is dirty, clean it using some absorbent cotton or soft cloth.
- (f) The desirable cleaners are water, IPA(Isopropyl Alcohol) or Hexane. Do not use Ketone type materials(ex. Acetone), Ethyl alcohol, Toluene, Ethyl acid or Methyl chloride. It might permanent damage to the polarizer due to chemical reaction.
- (g) If the liquid crystal material leaks from the panel, it should be kept away from the eyes or mouth. In case of contact with hands, legs or clothes, it must be washed away thoroughly with soap.
- (h) Protect the module from static , it may cause damage to the Integrated Gate Circuit.
- (i) Use finger-stalls with soft gloves in order to keep display clean during the incoming inspection and assembly process.
- (j) Do not disassemble the module.
- (k) Protection film for polarizer on the module shall be slowly peeled off just before use so that the electrostatic charge can be minimized.
- (l) Pins of I/F connector shall not be touched directly with bare hands

11.2 Storage

- (a) Do not leave the panel in high temperature, and high humidity for a long time. It is highly recommended to store the module with temperature from 0 to 35°C and relative humidity of less than 70%.
- (b) Do not store the TFT-LCD module in direct sunlight.
- (c) The module shall be stored in a dark place. It is prohibited to apply sunlight or fluorescent light during the store.

11.3 Operation

- (a) Do not connect, disconnect the module in the "Power On" condition.
- (b) Power supply should always be turned on/off by the "Power on/off sequence"

11.4 Others

- (a) The Liquid crystal is deteriorated by ultraviolet, do not leave it in direct sunlight and strong ultraviolet ray for many hours.
- (b) Avoid condensation of water. It may result in improper operation or disconnection of electrode.
- (c) Do not exceed the absolute maximum rating value. (the supply voltage variation, input voltage variation, variation in part contents and environmental temperature, and so on) Otherwise the panel may be damaged.
- (d) If the panel displays the same pattern continuously for a long period of time, it can be the situation when the image "Sticks" to the screen.
- (e) This panel has its circuitry FPC on the bottom side and should be handled carefully in order not to be stressed.