

Netz

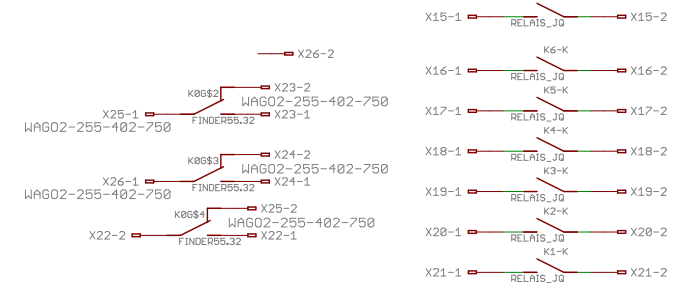

Stromversorgung

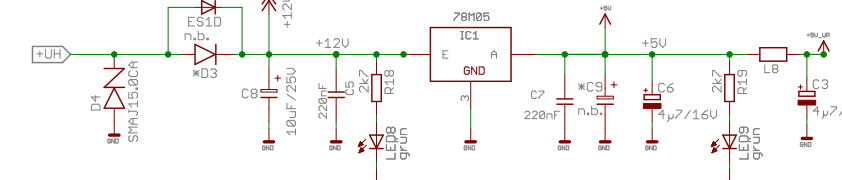

Uhr + EEPROM



Display

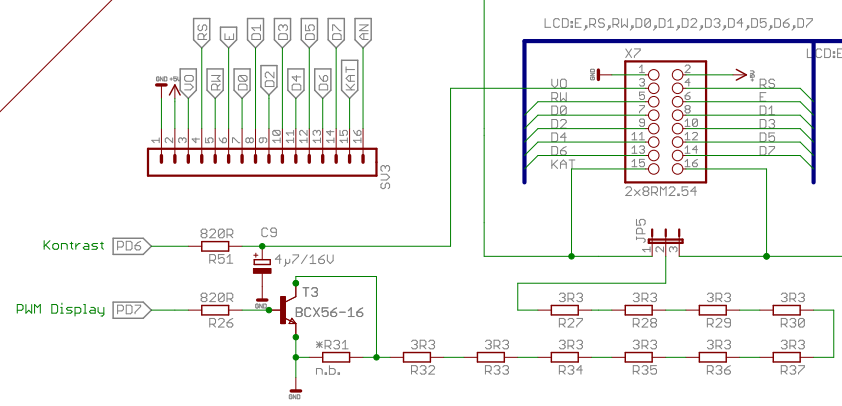

Digital Out

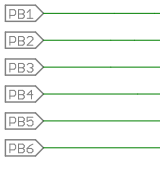

Digital Out

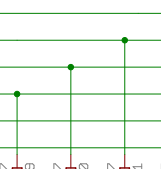

Analog

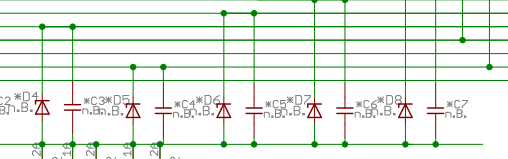

Digital In

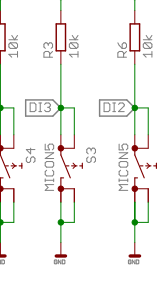

Port E

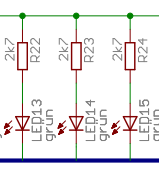

Port B



IC2 MAX232

