

## Request For Quotation

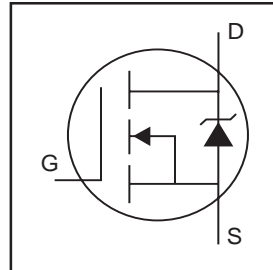
Order the parts you need from our real-time inventory database. Simply complete a request for quotation form with your part information and a sales representative will respond to you with price and availability.

[Request For Quotation](#)

**Your free datasheet starts on the next page.**

More datasheets and data books are available from our homepage: <http://www.datasheetarchive.com>

- Logic-Level Gate Drive
- Surface Mount (IRLR024N)
- Straight Lead (IRLU024N)
- Advanced Process Technology
- Fast Switching
- Fully Avalanche Rated

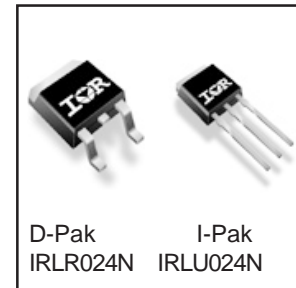


|                            |
|----------------------------|
| $V_{DSS} = 55V$            |
| $R_{DS(on)} = 0.065\Omega$ |
| $I_D = 17A$                |

### Description

Fifth Generation HEXFET® Power MOSFETs from International Rectifier utilize advanced processing techniques to achieve the lowest possible on-resistance per silicon area. This benefit, combined with the fast switching speed and ruggedized device design that HEXFET power MOSFETs are well known for, provides the designer with an extremely efficient device for use in a wide variety of applications.

The D-PAK is designed for surface mounting using vapor phase, infrared, or wave soldering techniques. The straight lead version (IRFU series) is for through-hole mounting applications. Power dissipation levels up to 1.5 watts are possible in typical surface mount applications.



D-Pak IRLR024N      I-Pak IRLU024N

### Absolute Maximum Ratings

|                           | Parameter                                | Max.                   | Units |
|---------------------------|--|------------------------|-------|
| $I_D @ T_C = 25^\circ C$  | Continuous Drain Current, $V_{GS} @ 10V$ | 17                     | A     |
| $I_D @ T_C = 100^\circ C$ | Continuous Drain Current, $V_{GS} @ 10V$ | 12                     |       |
| $I_{DM}$                  | Pulsed Drain Current ①                   | 72                     |       |
| $P_D @ T_C = 25^\circ C$  | Power Dissipation                        | 45                     | W     |
|                           | Linear Derating Factor                   | 0.3                    | W/°C  |
| $V_{GS}$                  | Gate-to-Source Voltage                   | $\pm 16$               | V     |
| $E_{AS}$                  | Single Pulse Avalanche Energy②           | 68                     | mJ    |
| $I_{AR}$                  | Avalanche Current①                       | 11                     | A     |
| $E_{AR}$                  | Repetitive Avalanche Energy①             | 4.5                    | mJ    |
| dv/dt                     | Peak Diode Recovery dv/dt ③              | 5.0                    | V/ns  |
| $T_J$                     | Operating Junction and                   | -55 to + 175           | °C    |
| $T_{STG}$                 | Storage Temperature Range                |                        |       |
|                           | Soldering Temperature, for 10 seconds    | 300 (1.6mm from case ) |       |

### Thermal Resistance

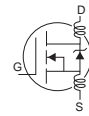
|                 | Parameter                     | Typ. | Max. | Units |
|-----------------|-------------------------------|------|------|-------|
| $R_{\theta JC}$ | Junction-to-Case              | —    | 3.3  | °C/W  |
| $R_{\theta JA}$ | Case-to-Ambient (PCB mount)** | —    | 50   |       |
| $R_{\theta JA}$ | Junction-to-Ambient           | —    | 110  |       |

\*\* When mounted on 1" square PCB (FR-4 or G-10 Material) .

For recommended footprint and soldering techniques refer to application note #AN-994

## Electrical Characteristics @ $T_J = 25^\circ\text{C}$ (unless otherwise specified)

|                                 | Parameter                            | Min. | Typ.  | Max.  | Units    | Conditions  |
|---------------------------------|--------------------------------------|------|-------|-------|----------|---|
| $V_{(BR)DSS}$                   | Drain-to-Source Breakdown Voltage    | 55   | —     | —     | V        | $V_{GS} = 0V, I_D = 250\mu A$   |
| $\Delta V_{(BR)DSS}/\Delta T_J$ | Breakdown Voltage Temp. Coefficient  | —    | 0.061 | —     | V/°C     | Reference to $25^\circ\text{C}, I_D = 1\text{mA}$                           |
| $R_{DS(on)}$                    | Static Drain-to-Source On-Resistance | —    | —     | 0.065 | $\Omega$ | $V_{GS} = 10V, I_D = 10A$ ④   |
|                                 |                                      | —    | —     | 0.080 |          | $V_{GS} = 5.0V, I_D = 10A$ ④  |
|                                 |                                      | —    | —     | 0.110 |          | $V_{GS} = 4.0V, I_D = 9.0A$ ④   |
| $V_{GS(th)}$                    | Gate Threshold Voltage               | 1.0  | —     | 2.0   | V        | $V_{DS} = V_{GS}, I_D = 250\mu A$   |
| $g_{fs}$                        | Forward Transconductance             | 8.3  | —     | —     | S        | $V_{DS} = 25V, I_D = 11A$   |
| $I_{DSS}$                       | Drain-to-Source Leakage Current      | —    | —     | 25    | $\mu A$  | $V_{DS} = 55V, V_{GS} = 0V$   |
|                                 |                                      | —    | —     | 250   |          | $V_{DS} = 44V, V_{GS} = 0V, T_J = 150^\circ\text{C}$                        |
| $I_{GSS}$                       | Gate-to-Source Forward Leakage       | —    | —     | 100   | nA       | $V_{GS} = 16V$  |
|                                 | Gate-to-Source Reverse Leakage       | —    | —     | -100  |          | $V_{GS} = -16V$   |
| $Q_g$                           | Total Gate Charge                    | —    | —     | 15    | nC       | $I_D = 11A$   |
| $Q_{gs}$                        | Gate-to-Source Charge                | —    | —     | 3.7   |          | $V_{DS} = 44V$  |
| $Q_{gd}$                        | Gate-to-Drain ("Miller") Charge      | —    | —     | 8.5   |          | $V_{GS} = 5.0V$ , See Fig. 6 and 13 ④ ⑥                                     |
| $t_{d(on)}$                     | Turn-On Delay Time                   | —    | 7.1   | —     | ns       | $V_{DD} = 28V$  |
| $t_r$                           | Rise Time                            | —    | 74    | —     |          | $I_D = 11A$   |
| $t_{d(off)}$                    | Turn-Off Delay Time                  | —    | 20    | —     |          | $R_G = 12\Omega, V_{GS} = 5.0V$   |
| $t_f$                           | Fall Time                            | —    | 29    | —     |          | $R_D = 2.4\Omega$ , See Fig. 10 ④ ⑥   |
| $L_D$                           | Internal Drain Inductance            | —    | 4.5   | —     | nH       | Between lead,<br>6mm (0.25in.)<br>from package<br>and center of die contact |
| $L_S$                           | Internal Source Inductance           | —    | 7.5   | —     |          |   |
| $C_{iss}$                       | Input Capacitance                    | —    | 480   | —     | pF       | $V_{GS} = 0V$   |
| $C_{oss}$                       | Output Capacitance                   | —    | 130   | —     |          | $V_{DS} = 25V$  |
| $C_{rss}$                       | Reverse Transfer Capacitance         | —    | 61    | —     |          | $f = 1.0\text{MHz}$ , See Fig. 5 ⑥  |



## Source-Drain Ratings and Characteristics

|          | Parameter                              | Min.  | Typ. | Max. | Units | Conditions   |
|----------|--|---|------|------|-------|--|
| $I_S$    | Continuous Source Current (Body Diode) | —   | —    | 17   | A     | MOSFET symbol showing the integral reverse p-n junction diode. |
| $I_{SM}$ | Pulsed Source Current (Body Diode) ①   | —   | —    | 72   |       |  |
| $V_{SD}$ | Diode Forward Voltage                  | —   | —    | 1.3  | V     | $T_J = 25^\circ\text{C}, I_S = 11A, V_{GS} = 0V$ ④             |
| $t_{rr}$ | Reverse Recovery Time                  | —   | 60   | 90   | ns    | $T_J = 25^\circ\text{C}, I_F = 11A$                            |
| $Q_{rr}$ | Reverse Recovery Charge                | —   | 130  | 200  | nC    | $di/dt = 100A/\mu s$ ④   |
| $t_{on}$ | Forward Turn-On Time                   | Intrinsic turn-on time is negligible (turn-on is dominated by $L_S + L_D$ ) |      |      |       |  |

### Notes:

- ① Repetitive rating; pulse width limited by max. junction temperature. (See fig. 11)
- ②  $V_{DD} = 25V$ , starting  $T_J = 25^\circ\text{C}$ ,  $L = 790\mu H$ ,  $R_G = 25\Omega$ ,  $I_{AS} = 11A$ . (See Figure 12)
- ③  $I_{SD} \leq 11A$ ,  $di/dt \leq 290A/\mu s$ ,  $V_{DD} \leq V_{(BR)DSS}$ ,  $T_J \leq 175^\circ\text{C}$

④ Pulse width  $\leq 300\mu s$ ; duty cycle  $\leq 2\%$ .

⑤ This is applied for I-PAK,  $L_S$  of D-PAK is measured between lead and center of die contact

⑥ Uses IRLZ24N data and test conditions.

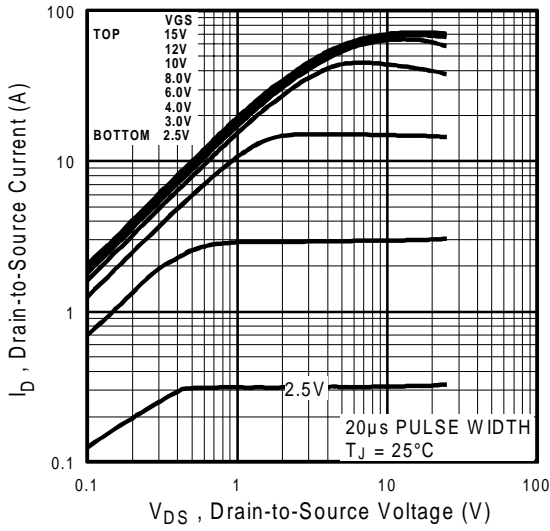


Fig 1. Typical Output Characteristics

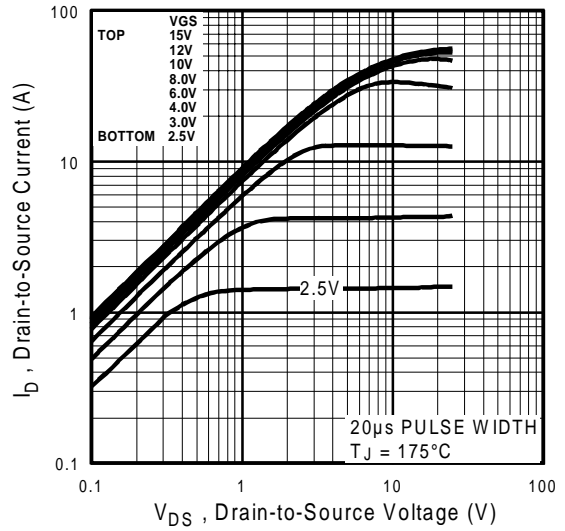


Fig 2. Typical Output Characteristics

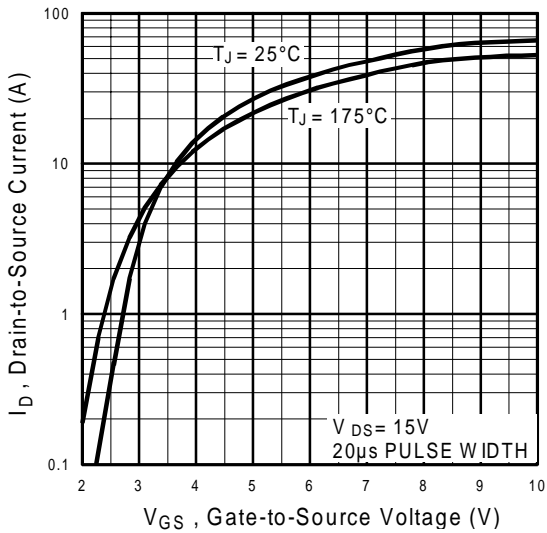


Fig 3. Typical Transfer Characteristics

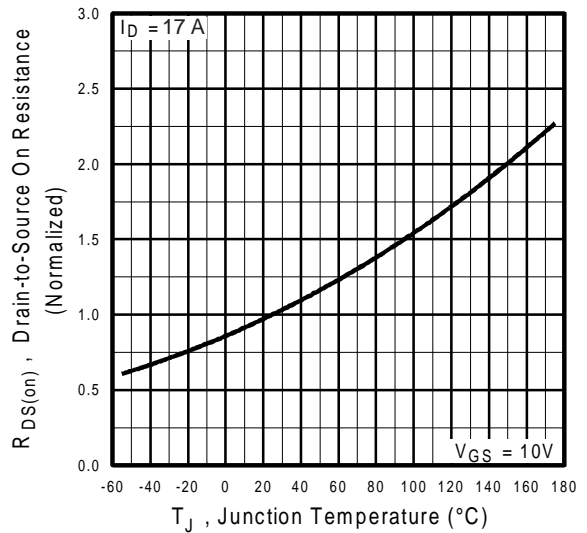
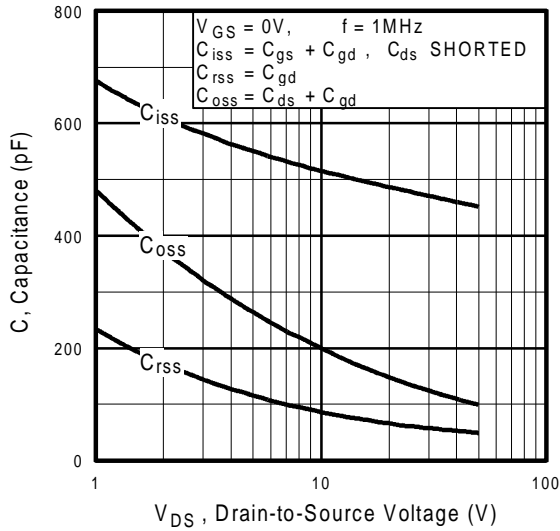
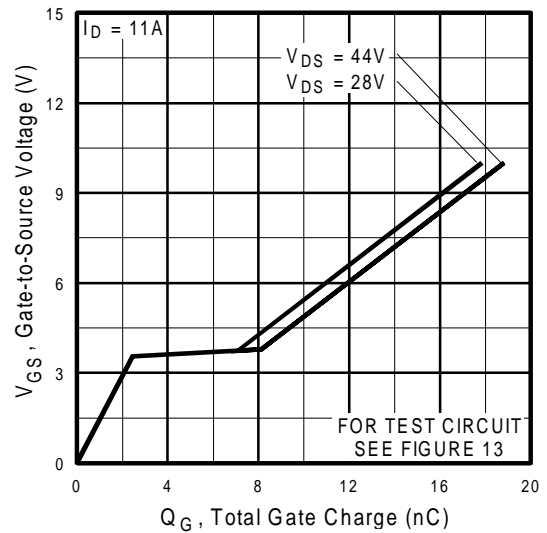


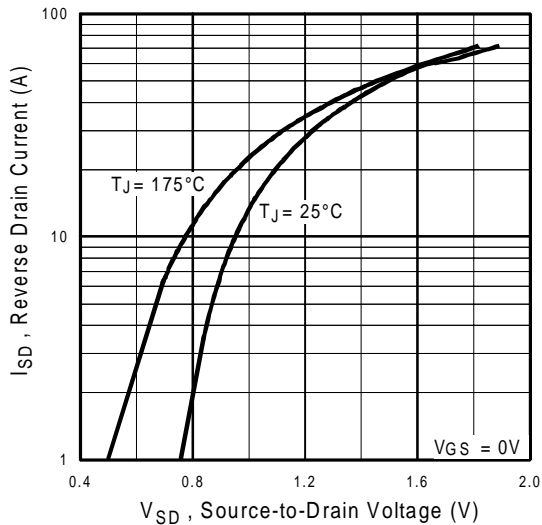
Fig 4. Normalized On-Resistance Vs. Temperature



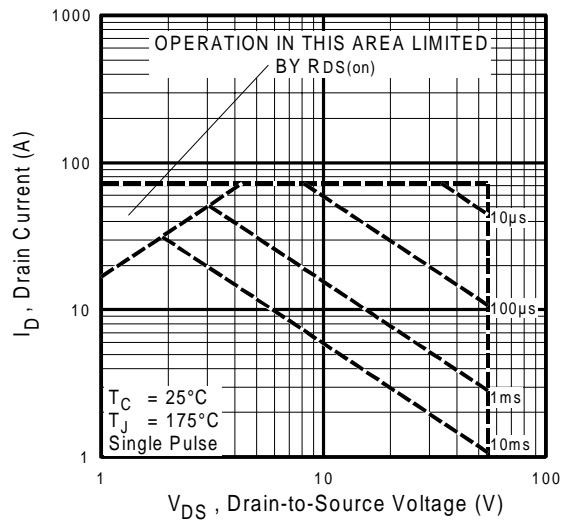
**Fig 5.** Typical Capacitance Vs. Drain-to-Source Voltage



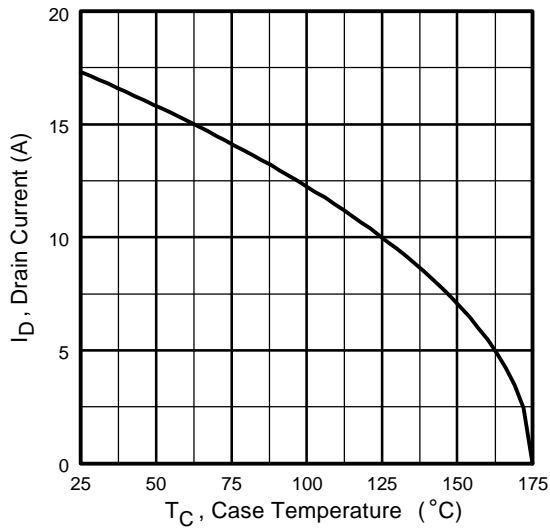
**Fig 6.** Typical Gate Charge Vs. Gate-to-Source Voltage



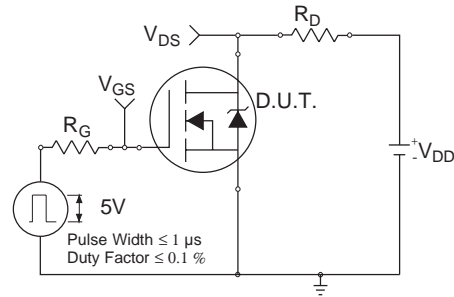
**Fig 7.** Typical Source-Drain Diode Forward Voltage



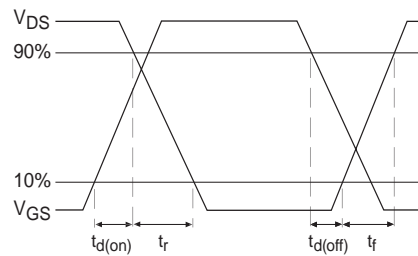
**Fig 8.** Maximum Safe Operating Area



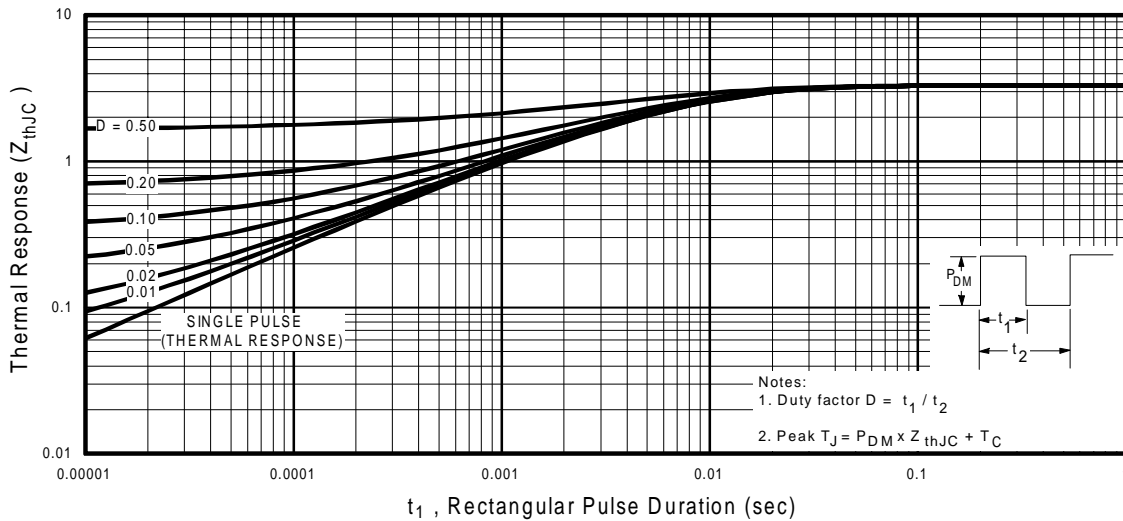
**Fig 9.** Maximum Drain Current Vs. Case Temperature



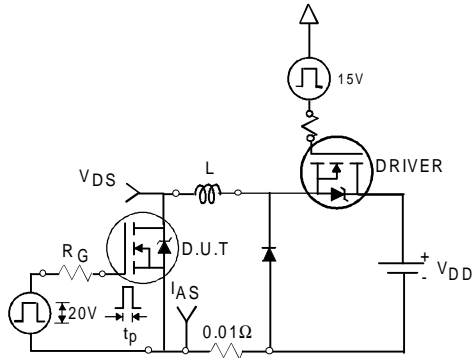
**Fig 10a.** Switching Time Test Circuit



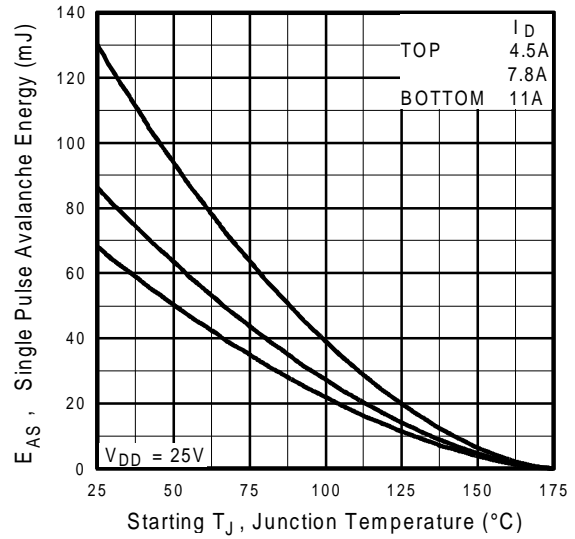
**Fig 10b.** Switching Time Waveforms



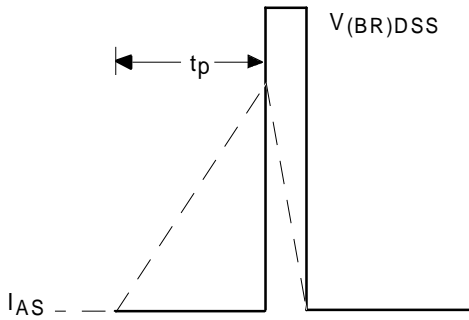
**Fig 11.** Maximum Effective Transient Thermal Impedance, Junction-to-Case



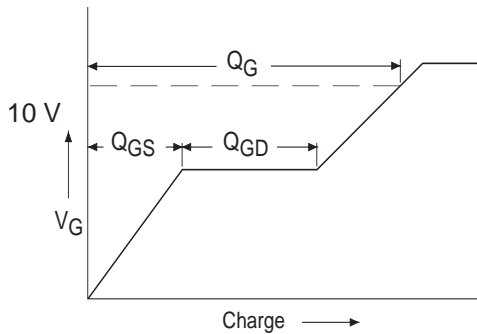
**Fig 12a.** Unclamped Inductive Test Circuit



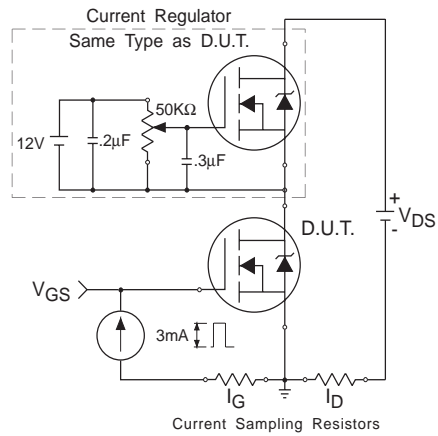
**Fig 12c.** Maximum Avalanche Energy Vs. Drain Current



**Fig 12b.** Unclamped Inductive Waveforms

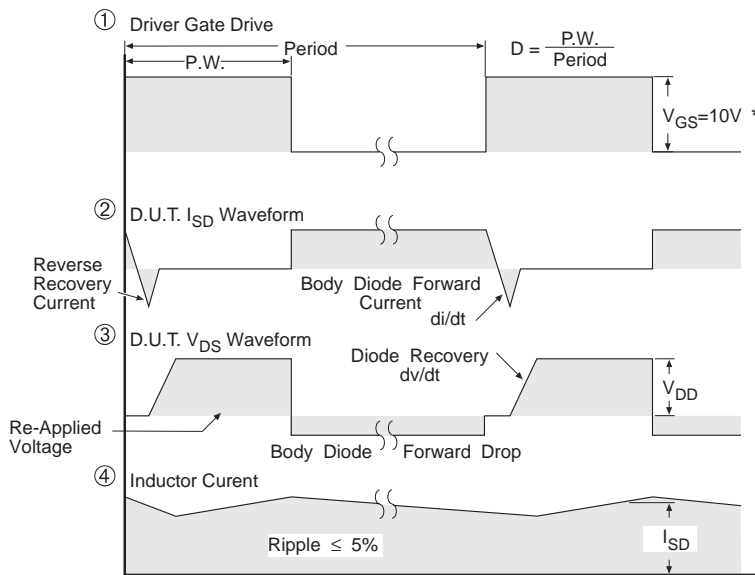
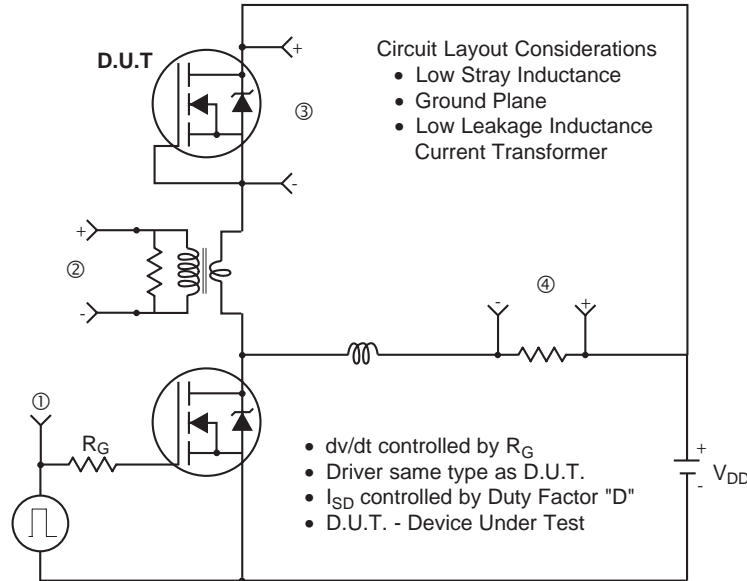


**Fig 13a.** Basic Gate Charge Waveform



**Fig 13b.** Gate Charge Test Circuit

**Peak Diode Recovery dv/dt Test Circuit**



\*  $V_{GS} = 5V$  for Logic Level Devices

**Fig 14.** For N-Channel HEXFET® MOSFETs

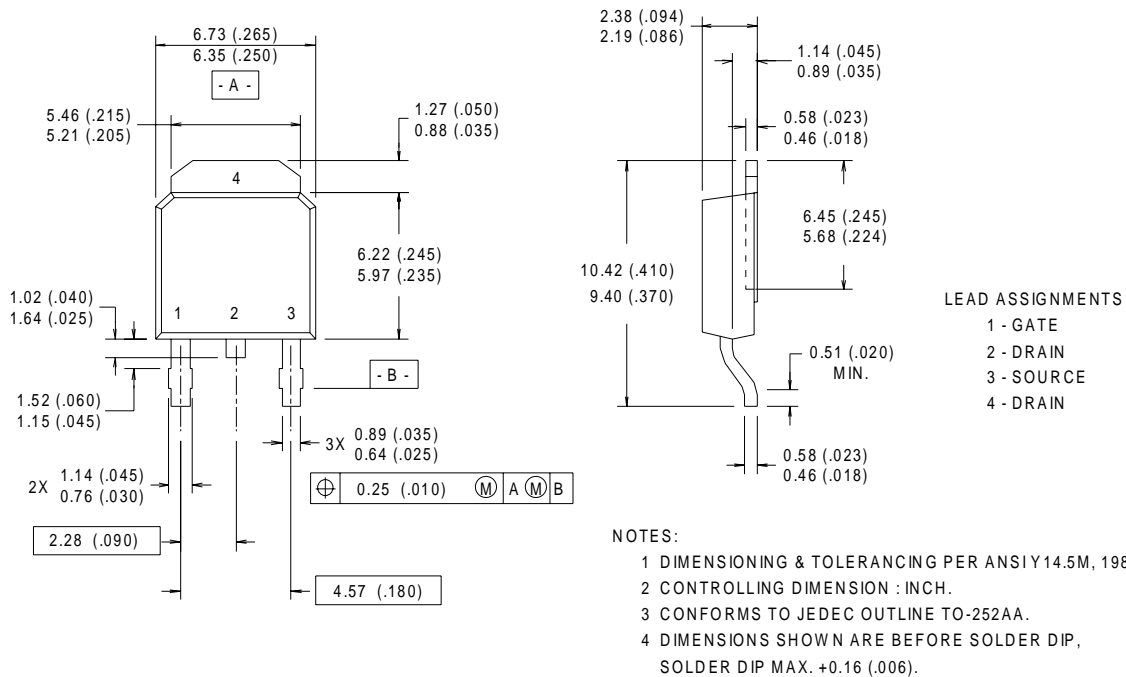


# IRLR/U024N

International  
**IR** Rectifier

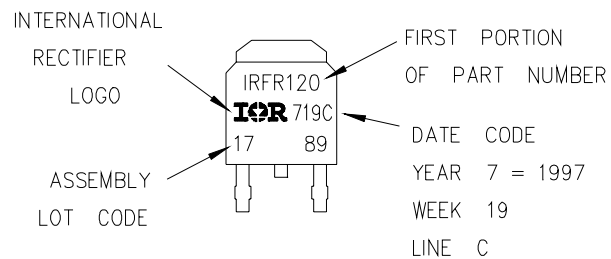
## D-Pak (TO-252AA) Package Outline

Dimensions are shown in millimeters (inches)



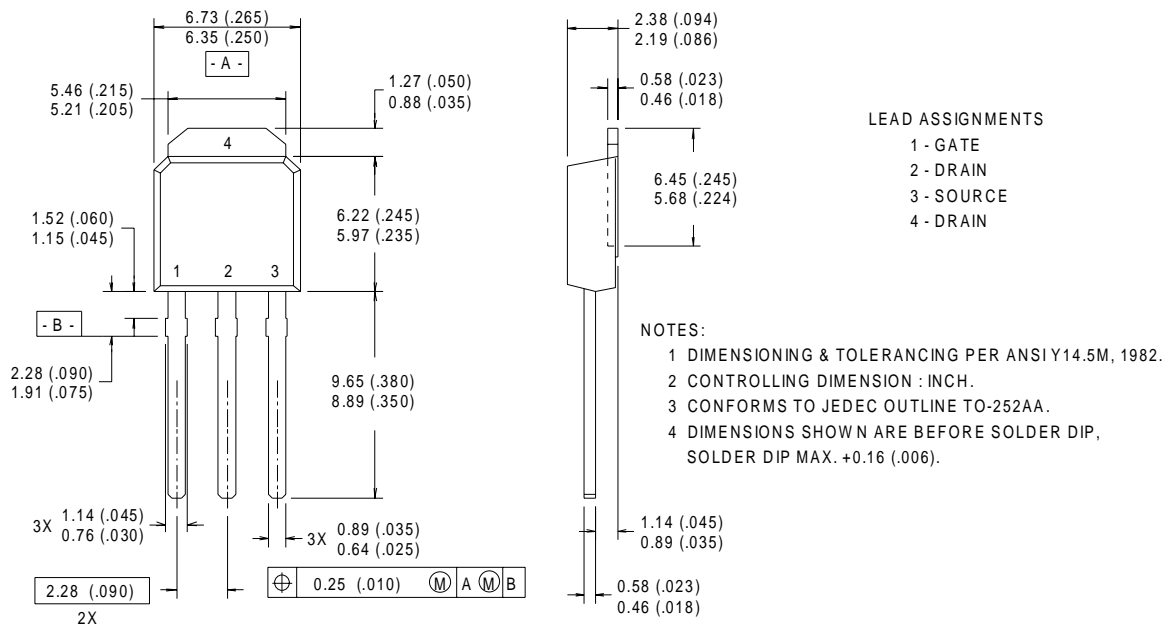
## D-Pak (TO-252AA) Part Marking Information

EXAMPLE: THIS IS AN IRFR120  
LOT CODE 1789  
ASSEMBLED ON WW 19, 1997  
IN THE ASSEMBLY LINE "C"



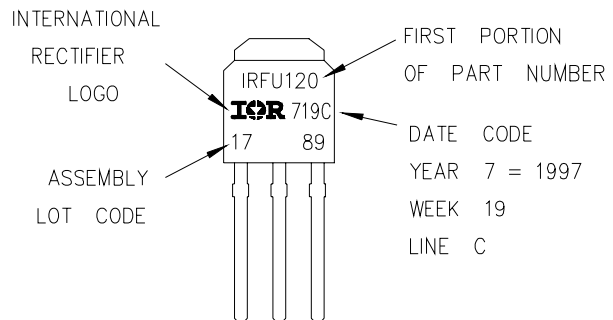
## I-Pak (TO-251AA) Package Outline

Dimensions are shown in millimeters (inches)



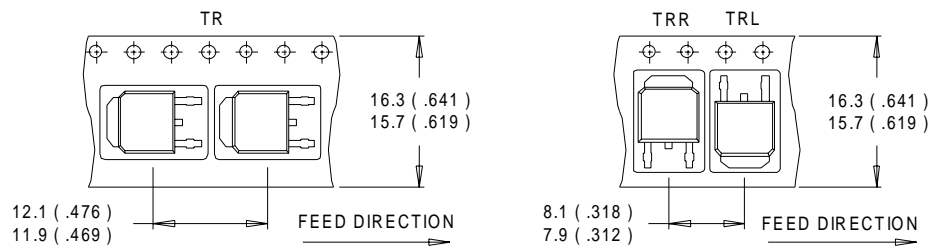
## I-Pak (TO-251AA) Part Marking Information

EXAMPLE: THIS IS AN IRFU120  
 LOT CODE 1789  
 ASSEMBLED ON WW 19, 1997  
 IN THE ASSEMBLY LINE "C"



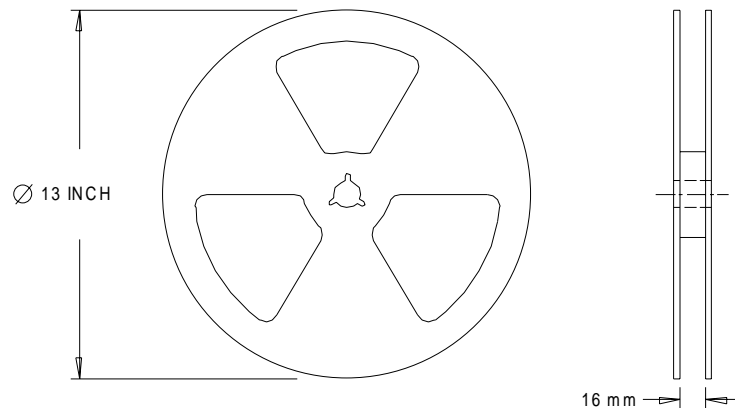
## D-Pak (TO-252AA) Tape & Reel Information

Dimensions are shown in millimeters (inches)



**NOTES :**

1. CONTROLLING DIMENSION : MILLIMETER.
2. ALL DIMENSIONS ARE SHOWN IN MILLIMETERS ( INCHES ).
3. OUTLINE CONFORMS TO EIA-481 & EIA-541.



**NOTES :**

1. OUTLINE CONFORMS TO EIA-481.