

LMV7219 7 nsec, 2.7V to 5V Comparator with Rail-to-Rail Output

Check for Samples: [LMV7219](#)

FEATURES

- ($V_S = 5V$, $T_A = 25^\circ C$, Typical Values Unless Specified)
- Propagation Delay 7ns
- Low Supply Current 1.1mA
- Input Common Mode Voltage Range Extends 200mV Below Ground
- Ideal for 2.7V and 5V Single Supply Applications
- Internal Hysteresis Ensures Clean Switching
- Fast Rise and Fall Time 1.3ns
- Available in Space-saving Packages: SC70 and SOT-23

DESCRIPTION

The LMV7219 is a low-power, high-speed comparator with internal hysteresis. The LMV7219 operating voltage ranges from 2.7V to 5V with push/pull rail-to-rail output. This device achieves a 7ns propagation delay while consuming only 1.1mA of supply current at 5V.

The LMV7219 inputs have a common mode voltage range that extends 200mV below ground, allowing ground sensing. The internal hysteresis ensures clean output transitions even with slow-moving inputs signals.

The LMV7219 is available in the SC70 and SOT-23 packages, which are ideal for systems where small size and low power are critical.

APPLICATIONS

- Portable and Battery-powered Systems
- Scanners
- Set Top Boxes
- High Speed Differential Line Receiver
- Window Comparators
- Zero-crossing Detectors
- High-speed Sampling Circuits

Typical Application

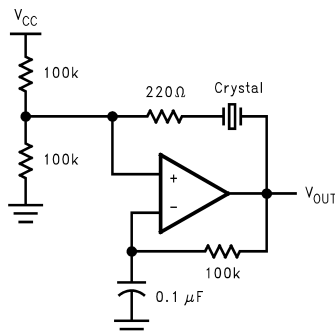

Please be aware that an important notice concerning availability, standard warranty, and use in critical applications of Texas Instruments semiconductor products and disclaimers thereto appears at the end of this data sheet.

All trademarks are the property of their respective owners.

Connection Diagram

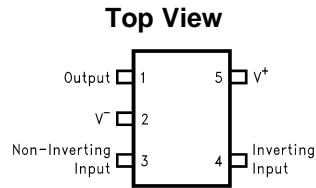

**Figure 1. SC70 and SOT-23 Packages
See Package Numbers DCK0005A and DBV0005A**

Simplified Schematic

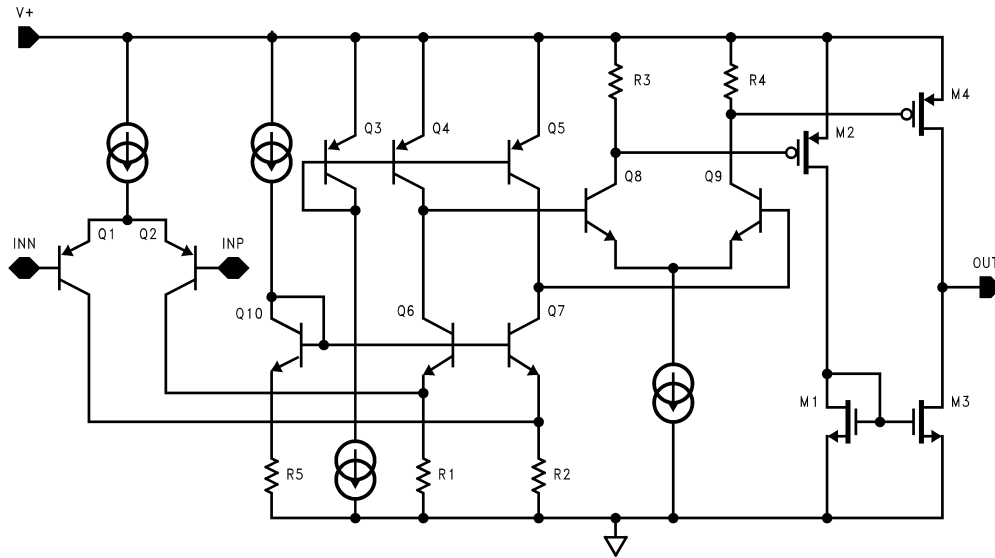

These devices have limited built-in ESD protection. The leads should be shorted together or the device placed in conductive foam during storage or handling to prevent electrostatic damage to the MOS gates.

Absolute Maximum Ratings⁽¹⁾⁽²⁾

ESD Tolerance ⁽³⁾	Machine Body	150V
	Human Model Body	2000V
Differential Input Voltage		± Supply Voltage
Output Short Circuit Duration		See ⁽⁴⁾
Supply Voltage (V ⁺ - V ⁻)		5.5V
Soldering Information	Infrared or Convection (20 sec)	235°C
	Wave Soldering (10 sec)	260°C (lead temp)
Voltage at Input/Output pins		(V ⁺) + 0.4V (V ⁻) - 0.4V
Current at Input Pin ⁽⁵⁾		±10mA
Maximum Junction Temperature		150°C

- (1) Absolute Maximum Ratings indicate limits beyond which damage to the device may occur. Operating Ratings indicate conditions for which the device is intended to be functional, but specific performance is not guaranteed. For guaranteed specifications and the test conditions, see the Electrical characteristics.
- (2) If Military/Aerospace specified devices are required, please contact the Texas Instruments Sales Office/ Distributors for availability and specifications.
- (3) Human body model, 1.5 kΩ in series with 100 pF. Machine model, 200Ω in series with 100 pF.
- (4) Applies to both single-supply and split-supply operation. Continuous short circuit operation at elevated ambient temperature can result in exceeding the maximum allowed junction temperature of 150°C. Output currents in excess of ±30mA over long term may adversely affect reliability.
- (5) Limiting input pin current is only necessary for input voltages that exceed absolute maximum input voltage ratings.

Operating Ratings

Supply voltages (V ⁺ - V ⁻)		2.7V to 5V
Operating Temperature Range ⁽¹⁾		-40°C to +85°C
Storage Temperature Range		-65°C to +150°C
Package Thermal Resistance	SC70	478°C/W
	SOT-23	265°C/W

- (1) The maximum power dissipation is a function of T_{J(MAX)}, θ_{JA}, and T_A. The maximum allowable power dissipation at any ambient temperature is P_D = (T_{J(MAX)} - T_A)/θ_{JA}. All numbers apply for packages soldered directly into a PC board.

2.7V Electrical Characteristics

Unless otherwise specified, all limits guaranteed for T_J = 25°C, V_{CM} = V⁺/2, V⁺ = 2.7V, V⁻ = 0V, C_L = 10 pF and R_L > 1 MΩ to V⁻. **Boldface** limits apply at the temperature extremes.

Parameter		Test Conditions	Typ ⁽¹⁾	Limit ⁽²⁾	Units
V _{OS}	Input Offset Voltage		1	6 8	mV max
I _B	Input Bias Current		450	950 2000	nA max
I _{OS}	Input Offset Current		50	200 400	nA max
CMRR	Common Mode Rejection Ratio	0V < V _{CM} < 1.50V	85	62 55	dB min
PSRR	Power Supply Rejection Ratio	V ⁺ = 2.7V to 5V	85	65 55	dB min
V _{CM}	Input Common-Voltage Range	CMRR > 50 dB	V _{CC} -1	V _{CC} -1.2 V_{CC} -1.3	V min
			-0.2	-0.1 0	V max

- (1) Typical Values represent the most likely parametric norm.
- (2) All limits are guaranteed by testing or statistical analysis.

2.7V Electrical Characteristics (continued)

Unless otherwise specified, all limits guaranteed for $T_J = 25^\circ\text{C}$, $V_{CM} = V^+/2$, $V^+ = 2.7\text{V}$, $V^- = 0\text{V}$, $C_L = 10\text{ pF}$ and $R_L > 1\text{ M}\Omega$ to V^- . **Boldface** limits apply at the temperature extremes.

Parameter		Test Conditions	Typ ⁽¹⁾	Limit ⁽²⁾	Units
V _O	Output Swing High	I _L = 4 mA, V _{ID} = 500 mV	V _{CC} -0.22	V _{CC} -0.3 V_{CC} -0.4	V min
		I _L = 0.4 mA, V _{ID} = 500 mV	V _{CC} -0.02	V _{CC} -0.05 V_{CC} -0.15	
	Output Swing Low	I _L = -4 mA, V _{ID} = -500 mV	130	200 300	mV max
		I _L = -0.4 mA, V _{ID} = -500 mV	15	50 150	
I _{SC}	Output Short Circuit Current	Sourcing, V _O = 0V ⁽³⁾	20		mA
		Sinking, V _O = 2.7V ⁽³⁾	20		
I _S	Supply Current	No Load	0.9	1.6 2.2	mA max
V _{HYST}	Input Hysteresis Voltage	See ⁽⁴⁾	7		mV
V _{TRIP+}	Input Referred Positive Trip Point	(see Figure 15)	3	8	mV max
V _{TRIP-}	Input Referred Negative Trip Point	(see Figure 15)	-4	-8	mV min
t _{PD}	Propagation Delay	Overdrive = 5 mV V _{CM} = 0V ⁽⁵⁾	12		ns max
		Overdrive = 15 mV V _{CM} = 0V ⁽⁵⁾	11		
		Overdrive = 50 mV V _{CM} = 0V ⁽⁵⁾	10	20	
t _{SKEW}	Propagation Delay Skew	See ⁽⁶⁾	1		ns
t _r	Output Rise Time	10% to 90%	2.5		ns
t _f	Output Fall Time	90% to 10%	2		ns

(3) Applies to both single-supply and split-supply operation. Continuous short circuit operation at elevated ambient temperature can result in exceeding the maximum allowed junction temperature of 150°C. Output currents in excess of ±30mA over long term may adversely affect reliability.

(4) The LMV7219 comparator has internal hysteresis. The trip points are the input voltage needed to change the output state in each direction. The offset voltage is defined as the average of V_{trip+} and V_{trip-}, while the hysteresis voltage is the difference of these two.

(5) Propagation delay measurements made with 100 mV steps. Overdrive is measure relative to V_{TRIP-}.

(6) Propagation Delay Skew is defined as absolute value of the difference between t_{PD LH} and t_{PD HL}.

5V Electrical Characteristics

Unless otherwise specified, all limits guaranteed for $T_J = 25^\circ\text{C}$, $V_{CM} = V^+/2$, $V^+ = 5\text{V}$, $V^- = 0\text{V}$, $C_L = 10\text{ pF}$ and $R_L > 1\text{ M}\Omega$ to V^- . **Boldface** limits apply at the temperature extremes.

Parameter		Test Conditions	Typ ⁽¹⁾	Limit ⁽²⁾	Units
V _{OS}	Input Offset Voltage		1	6 8	mV max
I _B	Input Bias Current		500	950 2000	nA max
I _{OS}	Input Offset Current		50	200 400	nA max
CMRR	Common Mode Rejection Ratio	0V < V _{CM} < 3.8V	85	65 55	dB min
PSRR	Power Supply Rejection Ratio	V ⁺ = 2.7V to 5V	85	65 55	dB min

(1) Typical Values represent the most likely parametric norm.

(2) All limits are guaranteed by testing or statistical analysis.

5V Electrical Characteristics (continued)

Unless otherwise specified, all limits guaranteed for $T_J = 25^\circ\text{C}$, $V_{CM} = V^+/2$, $V^+ = 5\text{V}$, $V^- = 0\text{V}$, $C_L = 10\text{ pF}$ and $R_L > 1\text{ M}\Omega$ to V^- . **Boldface** limits apply at the temperature extremes.

Parameter	Test Conditions	Typ ⁽¹⁾	Limit ⁽²⁾	Units	
V_{CM}	Input Common-Mode Voltage Range	CMRR > 50 dB	$V_{CC} - 1$	$V_{CC} - 1.2$ $V_{CC} - 1.3$	V min
			-0.2	-0.1 0	V max
V_O	Output Swing High	$I_L = 4\text{ mA}$, $V_{ID} = 500\text{ mV}$	$V_{CC} - 0.13$	$V_{CC} - 0.2$ $V_{CC} - 0.3$	V min
		$I_L = 0.4\text{ mA}$, $V_{ID} = 500\text{ mV}$	$V_{CC} - 0.02$	$V_{CC} - 0.05$ $V_{CC} - 0.15$	
	Output Swing Low	$I_L = -4\text{ mA}$, $V_{ID} = -500\text{ mV}$	80	180 280	mV max
		$I_L = -0.4\text{ mA}$, $V_{ID} = -500\text{ mV}$	10	50 150	
I_{SC}	Output Short Circuit Current	Sourcing, $V_O = 0\text{V}^{(3)}$	68	30 20	mA min
		Sinking, $V_O = 5\text{V}^{(3)}$	65	30 20	
I_S	Supply Current	No Load	1.1	1.8 2.4	mA max
V_{HYST}	Input Hysteresis Voltage	See ⁽⁴⁾	7.5		mV
V_{TRIP^+}	Input Referred Positive Trip Point	(See Figure 15)	3.5	8	mV max
V_{TRIP^-}	Input Referred Negative Trip Point	(See Figure 15)	-4	-8	mV min
t_{PD}	Propagation Delay	Overdrive = 5 mV $V_{CM} = 0\text{V}^{(5)}$	9		ns max
		Overdrive = 15mV $V_{CM} = 0\text{V}^{(5)}$	8	20	
		Overdrive = 50 mV $V_{CM} = 0\text{V}^{(5)}$	7	19	
t_{SKEW}	Propagation Delay Skew	See ⁽⁶⁾	0.4		ns
t_r	Output Rise Time	10% to 90%	1.3		ns
t_f	Output Fall Time	90% to 10%	1.25		ns

(3) Applies to both single-supply and split-supply operation. Continuous short circuit operation at elevated ambient temperature can result in exceeding the maximum allowed junction temperature of 150°C . Output currents in excess of $\pm 30\text{mA}$ over long term may adversely affect reliability.

(4) The LMV7219 comparator has internal hysteresis. The trip points are the input voltage needed to change the output state in each direction. The offset voltage is defined as the average of V_{TRIP^+} and V_{TRIP^-} , while the hysteresis voltage is the difference of these two.

(5) Propagation delay measurements made with 100 mV steps. Overdrive is measure relative to V_{TRIP} .

(6) Propagation Delay Skew is defined as absolute value of the difference between t_{PDLH} and t_{PDHL} .

Typical Performance Characteristics

Unless otherwise specified, $V_S = 5V$, $C_L = 10\text{ pF}$, $T_A = 25^\circ\text{C}$

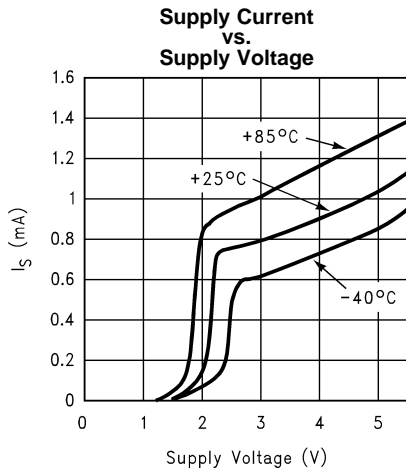

Figure 2.

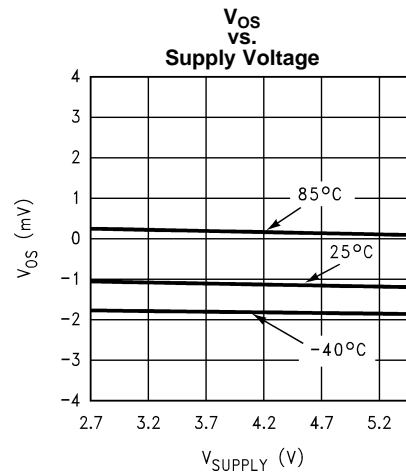

Figure 3.

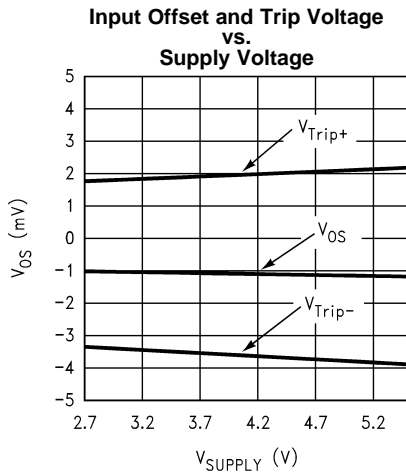

Figure 4.

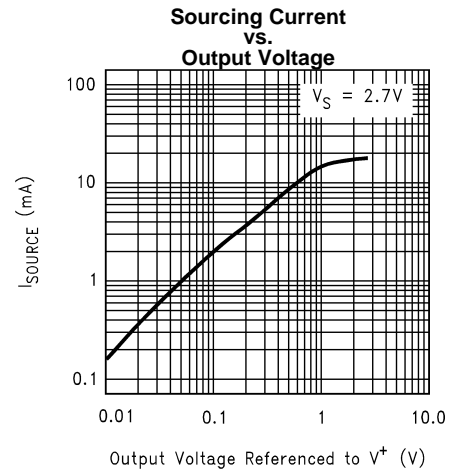

Figure 5.

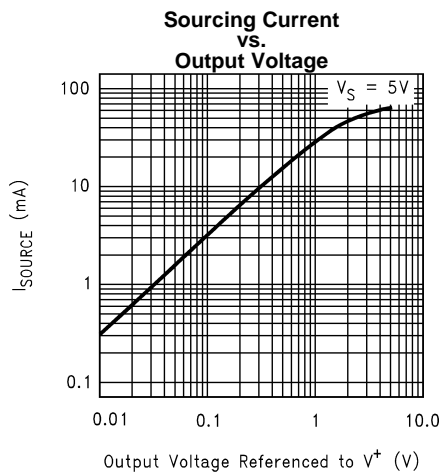

Figure 6.

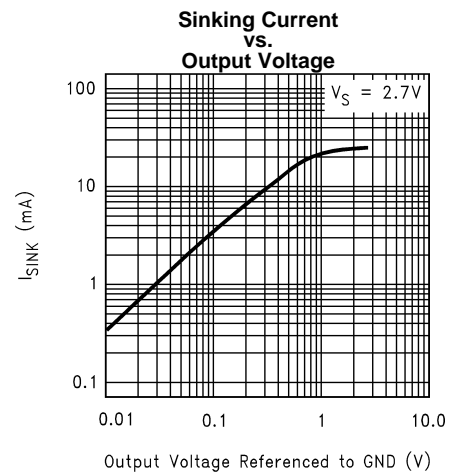

Figure 7.

Typical Performance Characteristics (continued)

Unless otherwise specified, $V_S = 5V$, $C_L = 10\text{ pF}$, $T_A = 25^\circ\text{C}$

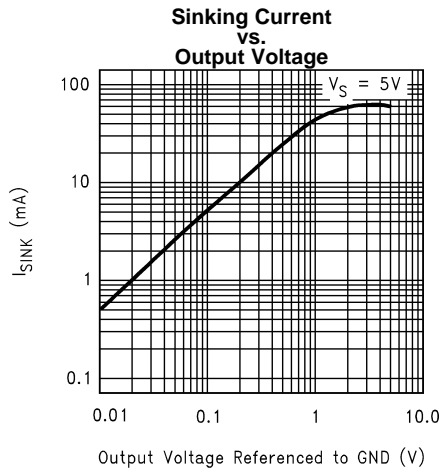

Figure 8.

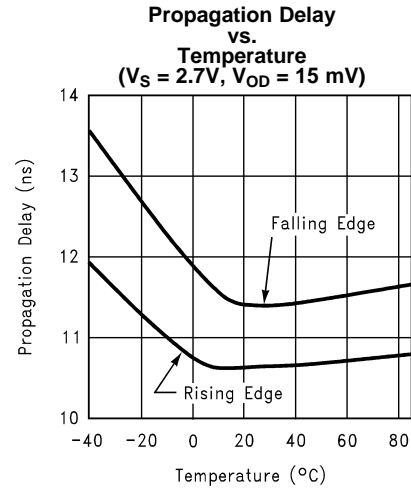

Figure 9.

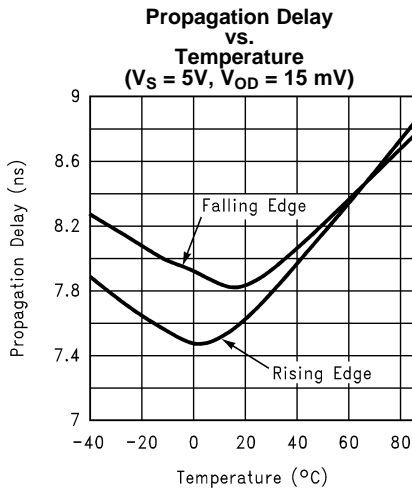

Figure 10.

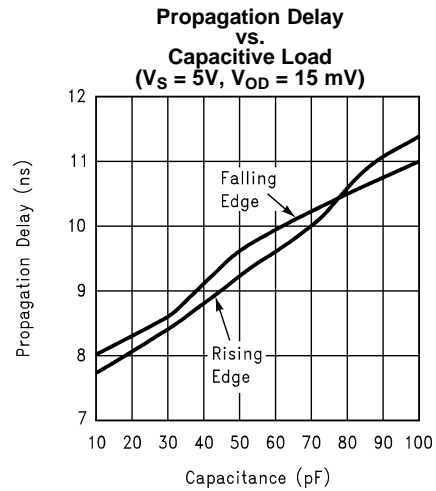

Figure 11.

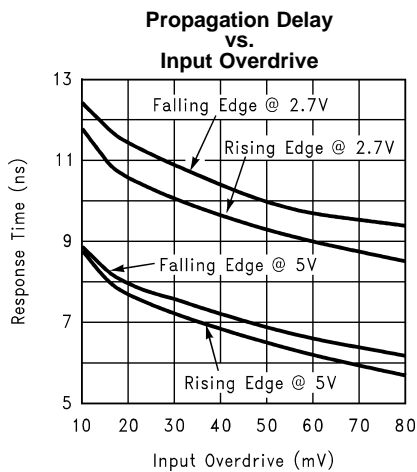

Figure 12.

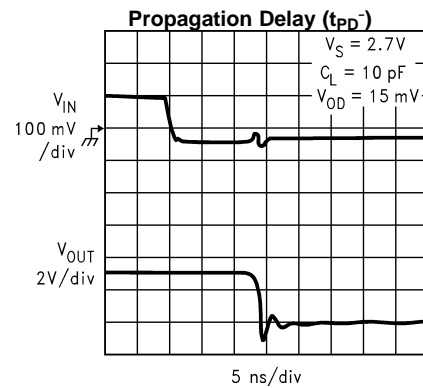
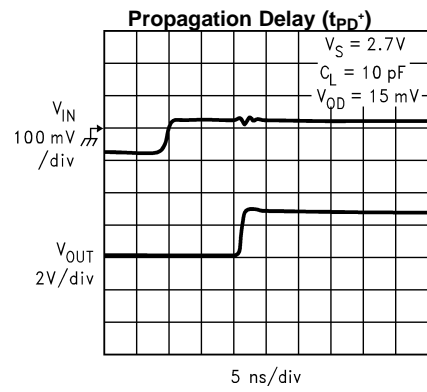

Figure 13.

Typical Performance Characteristics (continued)Unless otherwise specified, $V_S = 5V$, $C_L = 10\text{ pF}$, $T_A = 25^\circ\text{C}$ 

APPLICATION SECTION

LMV7219 is a single supply comparator with internal hysteresis, 7ns of propagation delay and only 1.1mA of supply current.

The LMV7219 has a typical input common mode voltage range of $-0.2V$ below the ground to $1V$ below V_{CC} . The differential input stage is a pair of PNP transistors, therefore, the input bias current flows out of the device. If either of the input signals falls below the negative common mode limit, the parasitic PN junction formed by the substrate and the base of the PNP will turn on, resulting in an increase of input bias current.

If one of the inputs goes above the positive common mode limit, the output will still maintain the correct logic level as long as the other input stays within the common mode range. However, the propagation delay will increase. When both inputs are outside the common mode voltage range, current saturation occurs in the input stage, and the output becomes unpredictable.

The propagation delay does not increase significantly with large differential input voltages. However, large differential voltages greater than the supply voltage should be avoided to prevent damages to the input stage.

The LMV7219 has a push pull output. When the output switches, there is a direct path between V_{CC} and ground, causing high output sinking or sourcing current during the transition. After the transition, the output current decreases and the supply current settles back to about 1.1mA at 5V, thus conserving power consumption.

Most high-speed comparators oscillate when the voltage of one of the inputs is close to or equal to the voltage on the other input due to noise or undesirable feedback. The LMV7219 have 7mV of internal hysteresis to counter parasitic effects and noise. The hysteresis does not change significantly with the supply voltages and the common mode input voltages as reflected in the specification table.

The internal hysteresis creates two trip points, one for the rising input voltage and one for the falling input voltage. The difference between the trip points is the hysteresis. With internal hysteresis, when the comparator's input voltages are equal, the hysteresis effectively causes one comparator-input voltage to move quickly past the other, thus taking the input out of the region where oscillation occurs. Standard comparators require hysteresis to be added with external resistors. The fixed internal hysteresis eliminates these resistors.

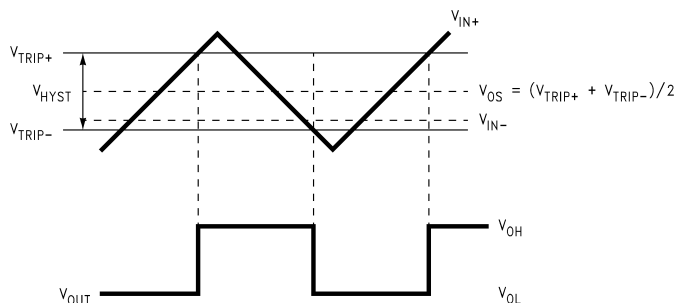

Figure 15. Input and Output Waveforms, Non-Inverting Input Varied

Additional Hysteresis

If additional hysteresis is desired, this can be done with the addition of three resistors using positive feedback, as shown in Figure 16. The positive feedback method slows the comparator response time. Calculate the resistor values as follows:

1) Select R3. The current through R3 should be greater than the input bias current to minimize errors. The current through R3 (I_F) at the trip point is $(V_{REF} - V_{OUT}) / R3$. Consider the two possible output states when solving for R3, and use the smaller of the two resulting resistor values. The two formulas are:

$$R3 = V_{REF} / I_F$$

where

- $V_{OUT} = 0$ (1)

$$R3 = V_{CC} - V_{REF} / I_F$$

where

- $V_{OUT} = V_{CC}$ (2)

- 2) Choose a hysteresis band required (V_{HB}).
- 3) Calculate R_1 , where $R_1 = R_3 \times (V_{HB}/V_{CC})$
- 4) Choose the trip point for V_{IN} rising. This is the threshold voltage (V_{THR}) at which the comparator switches from low to high as V_{IN} rises about the trip point.
- 5) Calculate R_2 as follows:

$$R_2 = \frac{1}{\left(\frac{V_{THR}}{V_{REF} \times R_1}\right) - \frac{1}{R_1} - \frac{1}{R_3}} \quad (3)$$

- 6) Verify the trip voltage and hysteresis as follows:

$$V_{IN} \text{ rising: } V_{THR} = V_{REF} \times R_1 \times \left(\frac{1}{R_1} + \frac{1}{R_2} + \frac{1}{R_3}\right)$$

$$V_{IN} \text{ falling: } V_{THF} = V_{THR} - \left(\frac{R_1 \times V_{CC}}{R_3}\right)$$

$$\text{Hysteresis} = V_{THR} - V_{THF} \quad (4)$$

This method is recommended for additional hysteresis of up to a few hundred millivolts. Beyond that, the impedance of R_3 is low enough to affect the bias string and adjustment of R_1 may be also required.

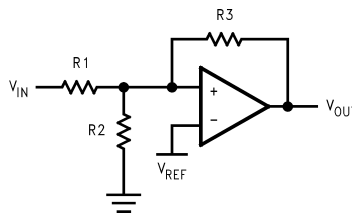

Figure 16. Additional Hysteresis

Circuit Layout and Bypassing

The LMV7219 requires high-speed layout. Follow these layout guidelines:

1. Power supply bypassing is critical, and will improve stability and transient response. A decoupling capacitor such as 0.1 μ F ceramic should be placed as close as possible to V^+ pin. An additional 2.2 μ F tantalum capacitor may be required for extra noise reduction.
2. Keep all leads short to reduce stray capacitance and lead inductance. It will also minimize unwanted parasitic feedback around the comparator.
3. The device should be soldered directly to the PC board instead of using a socket.
4. Use a PC board with a good, unbroken low inductance ground plane. Make sure ground paths are low-impedance, especially where heavier currents are flowing.
5. Input traces should be kept away from output traces. This can be achieved by running a topside ground plane between the output and inputs.
6. Run the ground trace under the device up to the bypass capacitor to shield the inputs from the outputs.
7. To prevent parasitic feedback when input signals are slow-moving, a small capacitor of 1000pF or less can be placed between the inputs. It can also help eliminate oscillations in the transition region. However, this capacitor can cause some degradation to t_{pd} when the source impedance is low.

Zero-Crossing Detector

The inverting input is connected to ground and the non-inverting input is connected to 100mVp-p signal. As the signal at the non-inverting input crosses 0V, the comparator's output Changes State.

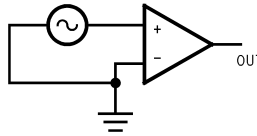

Figure 17. Zero-Crossing Detector

Threshold Detector

Instead of tying the inverting input to 0V, the inverting input can be tied to a reference voltage. The non-inverting input is connected to the input. As the input passes the V_{REF} threshold, the comparator's output changes state.

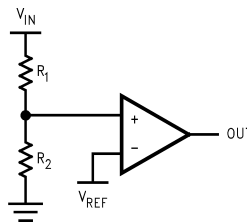

Figure 18. Threshold Detector

Crystal Oscillator

A simple crystal oscillator using the LMV7219 is shown below. Resistors R1 and R2 set the bias point at the comparator's non-inverting input. Resistors R3, R4 and C1 sets the inverting input node at an appropriate DC average level based on the output. The crystal's path provides resonant positive feedback and stable oscillation occurs. The output duty cycle for this circuit is roughly 50%, but it is affected by resistor tolerances and to a lesser extent by the comparator offset.

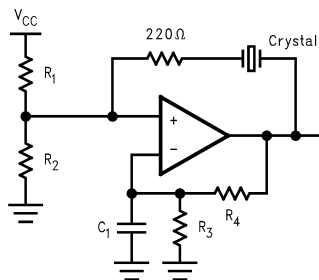

Figure 19. Crystal Oscillator

IR Receiver

The LMV7219 is an ideal candidate to be used as an infrared receiver. The infrared photo diode creates a current relative to the amount of infrared light present. The current creates a voltage across R_D . When this voltage level crosses the voltage applied by the voltage divider to the inverting input, the output transitions.

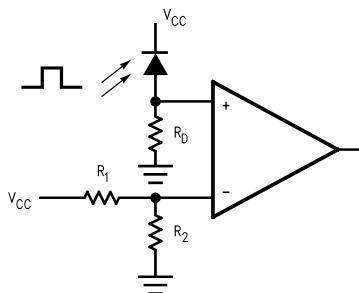

Figure 20. IR Receiver

PACKAGING INFORMATION

Orderable Device	Status (1)	Package Type	Package Drawing	Pins	Package Qty	Eco Plan (2)	Lead/Ball Finish	MSL Peak Temp (3)	Op Temp (°C)	Top-Side Markings (4)	Samples
LMV7219M5	ACTIVE	SOT-23	DBV	5	1000	TBD	CU SNPB	Level-1-260C-UNLIM	-40 to 85	C14A	Samples
LMV7219M5/NOPB	ACTIVE	SOT-23	DBV	5	1000	Green (RoHS & no Sb/Br)	CU SN	Level-1-260C-UNLIM	-40 to 85	C14A	Samples
LMV7219M5X	ACTIVE	SOT-23	DBV	5	3000	TBD	CU SNPB	Level-1-260C-UNLIM	-40 to 85	C14A	Samples
LMV7219M5X/NOPB	ACTIVE	SOT-23	DBV	5	3000	Green (RoHS & no Sb/Br)	CU SN	Level-1-260C-UNLIM	-40 to 85	C14A	Samples
LMV7219M7	ACTIVE	SC70	DCK	5	1000	TBD	CU SNPB	Level-1-260C-UNLIM	-40 to 85	C15	Samples
LMV7219M7/NOPB	ACTIVE	SC70	DCK	5	1000	Green (RoHS & no Sb/Br)	CU SN	Level-1-260C-UNLIM	-40 to 85	C15	Samples
LMV7219M7X	ACTIVE	SC70	DCK	5	3000	TBD	CU SNPB	Level-1-260C-UNLIM	-40 to 85	C15	Samples
LMV7219M7X/NOPB	ACTIVE	SC70	DCK	5	3000	Green (RoHS & no Sb/Br)	CU SN	Level-1-260C-UNLIM	-40 to 85	C15	Samples

(1) The marketing status values are defined as follows:

ACTIVE: Product device recommended for new designs.

LIFEBUY: TI has announced that the device will be discontinued, and a lifetime-buy period is in effect.

NRND: Not recommended for new designs. Device is in production to support existing customers, but TI does not recommend using this part in a new design.

PREVIEW: Device has been announced but is not in production. Samples may or may not be available.

OBSOLETE: TI has discontinued the production of the device.

(2) Eco Plan - The planned eco-friendly classification: Pb-Free (RoHS), Pb-Free (RoHS Exempt), or Green (RoHS & no Sb/Br) - please check <http://www.ti.com/productcontent> for the latest availability information and additional product content details.

TBD: The Pb-Free/Green conversion plan has not been defined.

Pb-Free (RoHS): TI's terms "Lead-Free" or "Pb-Free" mean semiconductor products that are compatible with the current RoHS requirements for all 6 substances, including the requirement that lead not exceed 0.1% by weight in homogeneous materials. Where designed to be soldered at high temperatures, TI Pb-Free products are suitable for use in specified lead-free processes.

Pb-Free (RoHS Exempt): This component has a RoHS exemption for either 1) lead-based flip-chip solder bumps used between the die and package, or 2) lead-based die adhesive used between the die and leadframe. The component is otherwise considered Pb-Free (RoHS compatible) as defined above.

Green (RoHS & no Sb/Br): TI defines "Green" to mean Pb-Free (RoHS compatible), and free of Bromine (Br) and Antimony (Sb) based flame retardants (Br or Sb do not exceed 0.1% by weight in homogeneous material)

(3) MSL, Peak Temp. -- The Moisture Sensitivity Level rating according to the JEDEC industry standard classifications, and peak solder temperature.

(4) Only one of markings shown within the brackets will appear on the physical device.

Important Information and Disclaimer: The information provided on this page represents TI's knowledge and belief as of the date that it is provided. TI bases its knowledge and belief on information provided by third parties, and makes no representation or warranty as to the accuracy of such information. Efforts are underway to better integrate information from third parties. TI has taken and continues to take reasonable steps to provide representative and accurate information but may not have conducted destructive testing or chemical analysis on incoming materials and chemicals. TI and TI suppliers consider certain information to be proprietary, and thus CAS numbers and other limited information may not be available for release.

In no event shall TI's liability arising out of such information exceed the total purchase price of the TI part(s) at issue in this document sold by TI to Customer on an annual basis.

TAPE AND REEL INFORMATION

QUADRANT ASSIGNMENTS FOR PIN 1 ORIENTATION IN TAPE

*All dimensions are nominal

Device	Package Type	Package Drawing	Pins	SPQ	Reel Diameter (mm)	Reel Width W1 (mm)	A0 (mm)	B0 (mm)	K0 (mm)	P1 (mm)	W (mm)	Pin1 Quadrant
LMV7219M5	SOT-23	DBV	5	1000	178.0	8.4	3.2	3.2	1.4	4.0	8.0	Q3
LMV7219M5/NOPB	SOT-23	DBV	5	1000	178.0	8.4	3.2	3.2	1.4	4.0	8.0	Q3
LMV7219M5X	SOT-23	DBV	5	3000	178.0	8.4	3.2	3.2	1.4	4.0	8.0	Q3
LMV7219M5X/NOPB	SOT-23	DBV	5	3000	178.0	8.4	3.2	3.2	1.4	4.0	8.0	Q3
LMV7219M7	SC70	DCK	5	1000	178.0	8.4	2.25	2.45	1.2	4.0	8.0	Q3
LMV7219M7/NOPB	SC70	DCK	5	1000	178.0	8.4	2.25	2.45	1.2	4.0	8.0	Q3
LMV7219M7X	SC70	DCK	5	3000	178.0	8.4	2.25	2.45	1.2	4.0	8.0	Q3
LMV7219M7X/NOPB	SC70	DCK	5	3000	178.0	8.4	2.25	2.45	1.2	4.0	8.0	Q3

TAPE AND REEL BOX DIMENSIONS

*All dimensions are nominal

Device	Package Type	Package Drawing	Pins	SPQ	Length (mm)	Width (mm)	Height (mm)
LMV7219M5	SOT-23	DBV	5	1000	203.0	190.0	41.0
LMV7219M5/NOPB	SOT-23	DBV	5	1000	203.0	190.0	41.0
LMV7219M5X	SOT-23	DBV	5	3000	206.0	191.0	90.0
LMV7219M5X/NOPB	SOT-23	DBV	5	3000	206.0	191.0	90.0
LMV7219M7	SC70	DCK	5	1000	203.0	190.0	41.0
LMV7219M7/NOPB	SC70	DCK	5	1000	203.0	190.0	41.0
LMV7219M7X	SC70	DCK	5	3000	206.0	191.0	90.0
LMV7219M7X/NOPB	SC70	DCK	5	3000	206.0	191.0	90.0

DBV (R-PDSO-G5)

PLASTIC SMALL-OUTLINE PACKAGE

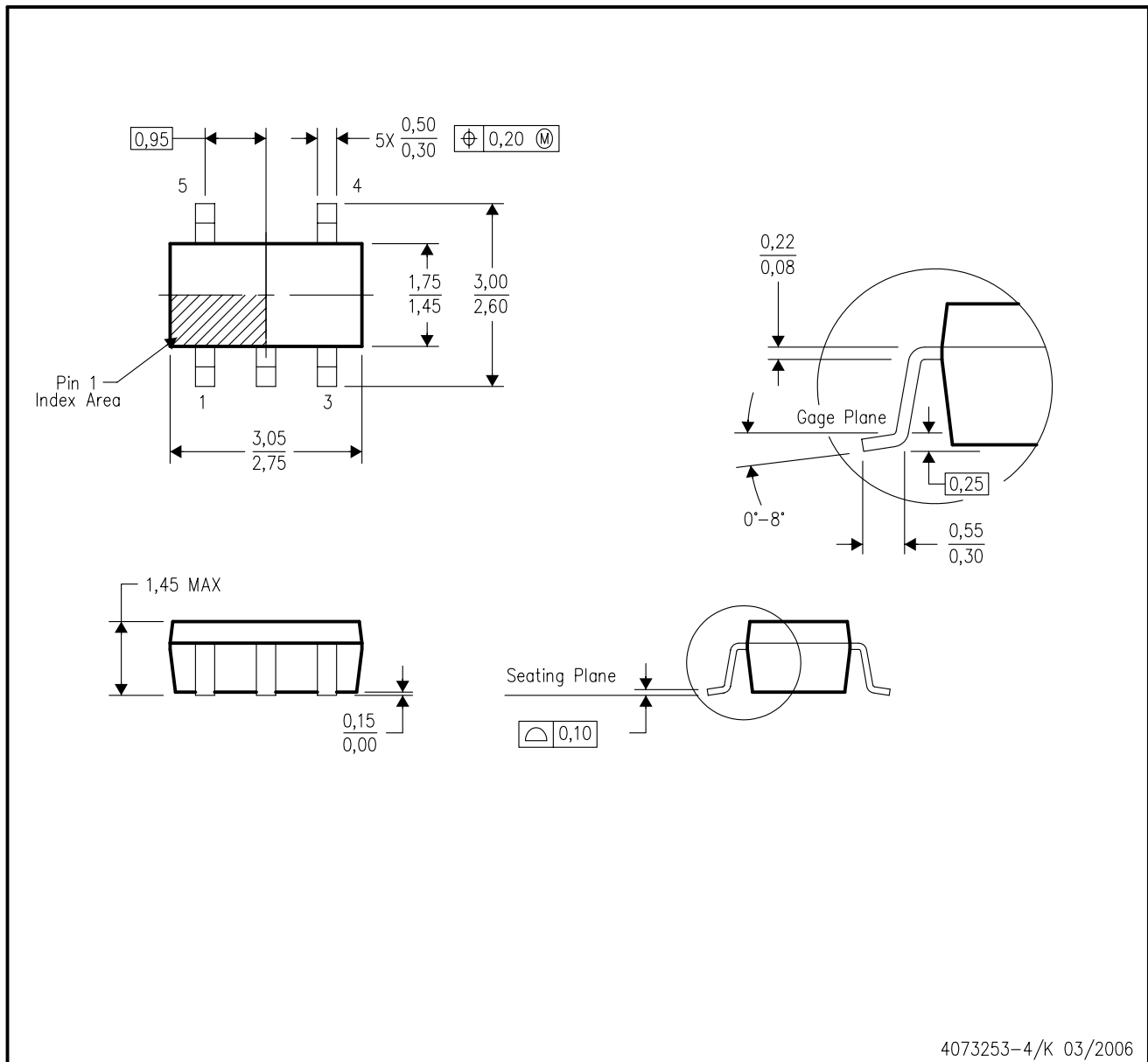

- NOTES:
- A. All linear dimensions are in millimeters.
 - B. This drawing is subject to change without notice.
 - C. Body dimensions do not include mold flash or protrusion. Mold flash and protrusion shall not exceed 0.15 per side.
 - D. Falls within JEDEC MO-178 Variation AA.

DBV (R-PDSO-G5)

PLASTIC SMALL OUTLINE



- NOTES:
- A. All linear dimensions are in millimeters.
 - B. This drawing is subject to change without notice.
 - C. Customers should place a note on the circuit board fabrication drawing not to alter the center solder mask defined pad.
 - D. Publication IPC-7351 is recommended for alternate designs.
 - E. Laser cutting apertures with trapezoidal walls and also rounding corners will offer better paste release. Customers should contact their board assembly site for stencil design recommendations. Example stencil design based on a 50% volumetric metal load solder paste. Refer to IPC-7525 for other stencil recommendations.

DCK (R-PDSO-G5)

PLASTIC SMALL-OUTLINE PACKAGE



- NOTES:
- A. All linear dimensions are in millimeters.
 - B. This drawing is subject to change without notice.
 - C. Body dimensions do not include mold flash or protrusion. Mold flash and protrusion shall not exceed 0.15 per side.
 - D. Falls within JEDEC MO-203 variation AA.

IMPORTANT NOTICE

Texas Instruments Incorporated and its subsidiaries (TI) reserve the right to make corrections, enhancements, improvements and other changes to its semiconductor products and services per JESD46, latest issue, and to discontinue any product or service per JESD48, latest issue. Buyers should obtain the latest relevant information before placing orders and should verify that such information is current and complete. All semiconductor products (also referred to herein as "components") are sold subject to TI's terms and conditions of sale supplied at the time of order acknowledgment.

TI warrants performance of its components to the specifications applicable at the time of sale, in accordance with the warranty in TI's terms and conditions of sale of semiconductor products. Testing and other quality control techniques are used to the extent TI deems necessary to support this warranty. Except where mandated by applicable law, testing of all parameters of each component is not necessarily performed.

TI assumes no liability for applications assistance or the design of Buyers' products. Buyers are responsible for their products and applications using TI components. To minimize the risks associated with Buyers' products and applications, Buyers should provide adequate design and operating safeguards.

TI does not warrant or represent that any license, either express or implied, is granted under any patent right, copyright, mask work right, or other intellectual property right relating to any combination, machine, or process in which TI components or services are used. Information published by TI regarding third-party products or services does not constitute a license to use such products or services or a warranty or endorsement thereof. Use of such information may require a license from a third party under the patents or other intellectual property of the third party, or a license from TI under the patents or other intellectual property of TI.

Reproduction of significant portions of TI information in TI data books or data sheets is permissible only if reproduction is without alteration and is accompanied by all associated warranties, conditions, limitations, and notices. TI is not responsible or liable for such altered documentation. Information of third parties may be subject to additional restrictions.

Resale of TI components or services with statements different from or beyond the parameters stated by TI for that component or service voids all express and any implied warranties for the associated TI component or service and is an unfair and deceptive business practice. TI is not responsible or liable for any such statements.

Buyer acknowledges and agrees that it is solely responsible for compliance with all legal, regulatory and safety-related requirements concerning its products, and any use of TI components in its applications, notwithstanding any applications-related information or support that may be provided by TI. Buyer represents and agrees that it has all the necessary expertise to create and implement safeguards which anticipate dangerous consequences of failures, monitor failures and their consequences, lessen the likelihood of failures that might cause harm and take appropriate remedial actions. Buyer will fully indemnify TI and its representatives against any damages arising out of the use of any TI components in safety-critical applications.

In some cases, TI components may be promoted specifically to facilitate safety-related applications. With such components, TI's goal is to help enable customers to design and create their own end-product solutions that meet applicable functional safety standards and requirements. Nonetheless, such components are subject to these terms.

No TI components are authorized for use in FDA Class III (or similar life-critical medical equipment) unless authorized officers of the parties have executed a special agreement specifically governing such use.

Only those TI components which TI has specifically designated as military grade or "enhanced plastic" are designed and intended for use in military/aerospace applications or environments. Buyer acknowledges and agrees that any military or aerospace use of TI components which have **not** been so designated is solely at the Buyer's risk, and that Buyer is solely responsible for compliance with all legal and regulatory requirements in connection with such use.

TI has specifically designated certain components as meeting ISO/TS16949 requirements, mainly for automotive use. In any case of use of non-designated products, TI will not be responsible for any failure to meet ISO/TS16949.

Products

Audio	www.ti.com/audio
Amplifiers	amplifier.ti.com
Data Converters	dataconverter.ti.com
DLP® Products	www.dlp.com
DSP	dsp.ti.com
Clocks and Timers	www.ti.com/clocks
Interface	interface.ti.com
Logic	logic.ti.com
Power Mgmt	power.ti.com
Microcontrollers	microcontroller.ti.com
RFID	www.ti-rfid.com
OMAP Applications Processors	www.ti.com/omap
Wireless Connectivity	www.ti.com/wirelessconnectivity

Applications

Automotive and Transportation	www.ti.com/automotive
Communications and Telecom	www.ti.com/communications
Computers and Peripherals	www.ti.com/computers
Consumer Electronics	www.ti.com/consumer-apps
Energy and Lighting	www.ti.com/energy
Industrial	www.ti.com/industrial
Medical	www.ti.com/medical
Security	www.ti.com/security
Space, Avionics and Defense	www.ti.com/space-avionics-defense
Video and Imaging	www.ti.com/video

TI E2E Community

e2e.ti.com