

# MOC3020 THRU MOC3023 OPTOCOUPLED/OPTOISOLATORS

SOES025A – OCTOBER 1986 – REVISED APRIL 1998

- 400 V Phototriac Driver Output
- Gallium-Arsenide-Diode Infrared Source and Optically-Coupled Silicon Triac Driver (Bilateral Switch)
- UL Recognized . . . File Number E65085
- High Isolation . . . 7500 V Peak
- Output Driver Designed for 220 Vac
- Standard 6-Terminal Plastic DIP
- Directly Interchangeable with Motorola MOC3020, MOC3021, MOC3022, and MOC3023

## typical 115/240 Vac(rms) applications

- Solenoid/Valve Controls
- Lamp Ballasts
- Interfacing Microprocessors to 115/240 Vac Peripherals
- Motor Controls
- Incandescent Lamp Dimmers

## MOC3020 – MOC3023 . . . PACKAGE (TOP VIEW)

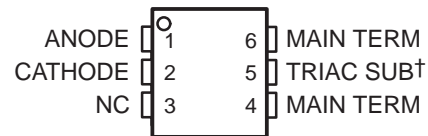

† Do not connect this terminal  
NC – No internal connection

## logic diagram

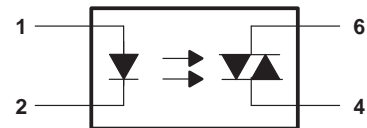

## absolute maximum ratings at 25°C free-air temperature (unless otherwise noted)†

Input-to-output peak voltage, 5 s maximum duration, 60 Hz (see Note 1)	7.5 kV
Input diode reverse voltage	3 V
Input diode forward current, continuous	50 mA
Output repetitive peak off-state voltage	400 V
Output on-state current, total rms value (50-60 Hz, full sine wave): $T_A = 25^\circ\text{C}$	100 mA
$T_A = 70^\circ\text{C}$	50 mA
Output driver nonrepetitive peak on-state current ( $t_w = 10$ ms, duty cycle = 10%, see Figure 7)	1.2 A
Continuous power dissipation at (or below) 25°C free-air temperature:	
Infrared-emitting diode (see Note 2)	100 mW
Phototriac (see Note 3)	300 mW
Total device (see Note 4)	330 mW
Operating junction temperature range, $T_J$	-40°C to 100°C
Storage temperature range, $T_{stg}$	-40°C to 150°C
Lead temperature 1,6 (1/16 inch) from case for 10 seconds	260°C

† Stresses beyond those listed under "absolute maximum ratings" may cause permanent damage to the device. These are stress ratings only, and functional operation of the device at these or any other conditions beyond those indicated under "recommended operating conditions" is not implied. Exposure to absolute-maximum-rated conditions for extended periods may affect device reliability.

- NOTES:
1. Input-to-output peak voltage is the internal device dielectric breakdown rating.
  2. Derate linearly to 100°C free-air temperature at the rate of 1.33 mW/°C.
  3. Derate linearly to 100°C free-air temperature at the rate of 4 mW/°C.
  4. Derate linearly to 100°C free-air temperature at the rate of 4.4 mW/°C.

# MOC3020 THRU MOC3023 OPTOCOUPLEDERS/OPTOISOLATORS

SOES025A – OCTOBER 1986 – REVISED APRIL 1998

## electrical characteristics at 25°C free-air temperature (unless otherwise noted)

PARAMETER		TEST CONDITIONS	MIN	TYP	MAX	UNIT
$I_R$	Static reverse current	$V_R = 3\text{ V}$		0.05	100	$\mu\text{A}$
$V_F$	Static forward voltage	$I_F = 10\text{ mA}$		1.2	1.5	V
$I_{(DRM)}$	Repetitive off-state current, either direction	$V_{(DRM)} = 400\text{ V}$ , See Note 5		10	100	nA
$dv/dt$	Critical rate of rise of off-state voltage	See Figure 1		100		$\text{V}/\mu\text{s}$
$dv/dt(c)$	Critical rate of rise of commutating voltage	$I_O = 15\text{ mA}$ , See Figure 1		0.15		$\text{V}/\mu\text{s}$
$I_{FT}$	Input trigger current, either direction	Output supply voltage = 3 V	MOC3020	15	30	mA
			MOC3021	8	15	
			MOC3022	5	10	
			MOC3023	3	5	
$V_{TM}$	Peak on-state voltage, either direction	$I_{TM} = 100\text{ mA}$		1.4	3	V
$I_H$	Holding current, either direction			100		$\mu\text{A}$

NOTE 5: Test voltage must be applied at a rate no higher than 12 V/ $\mu\text{s}$ .

## PARAMETER MEASUREMENT INFORMATION

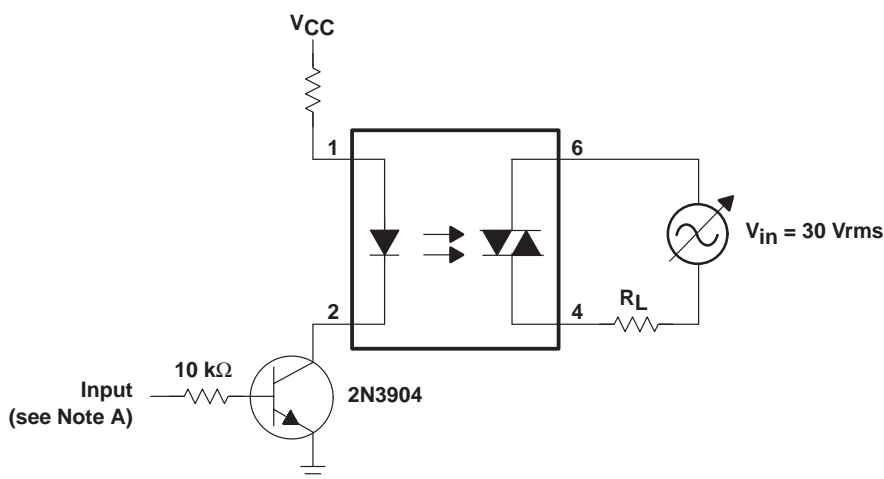

NOTE A. The critical rate of rise of off-state voltage,  $dv/dt$ , is measured with the input at 0 V. The frequency of  $V_{in}$  is increased until the phototriac turns on. This frequency is then used to calculate the  $dv/dt$  according to the formula:

$$dv/dt = 2\sqrt{2}\pi fV_{in}$$

The critical rate of rise of commutating voltage,  $dv/dt(c)$ , is measured by applying occasional 5-V pulses to the input and increasing the frequency of  $V_{in}$  until the phototriac stays on (latches) after the input pulse has ceased. With no further input pulses, the frequency of  $V_{in}$  is then gradually decreased until the phototriac turns off. The frequency at which turn-off occurs may then be used to calculate the  $dv/dt(c)$  according to the formula shown above.

Figure 1. Critical Rate of Rise Test Circuit

TYPICAL CHARACTERISTICS

EMITTING-DIODE TRIGGER CURRENT (NORMALIZED)  
vs  
FREE-AIR TEMPERATURE

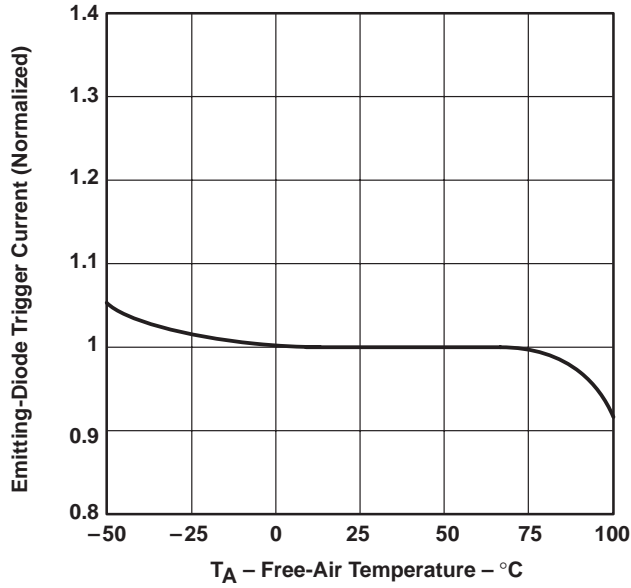

Figure 2

ON-STATE CHARACTERISTICS

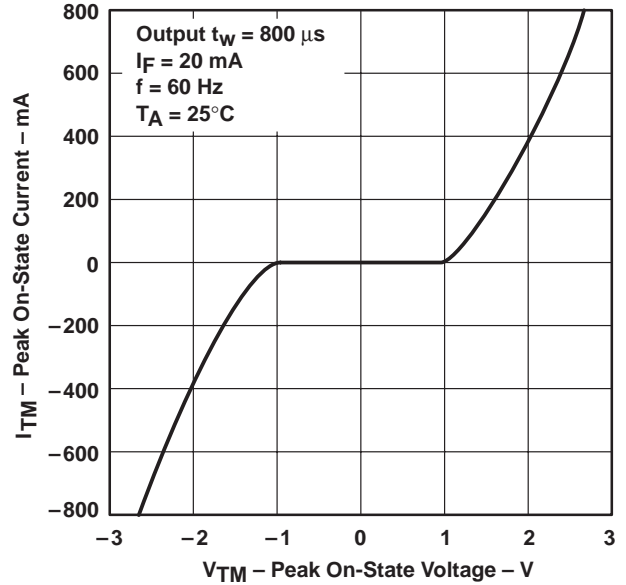

Figure 3

NONREPETITIVE PEAK ON-STATE CURRENT  
vs  
PULSE DURATION

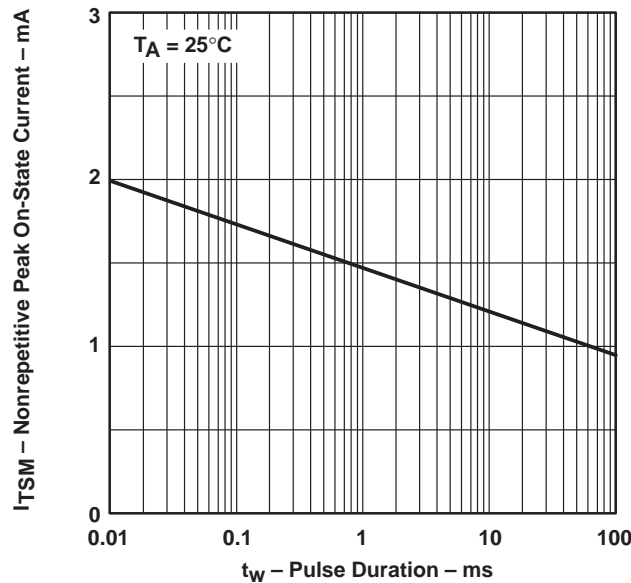

Figure 4

APPLICATIONS INFORMATION

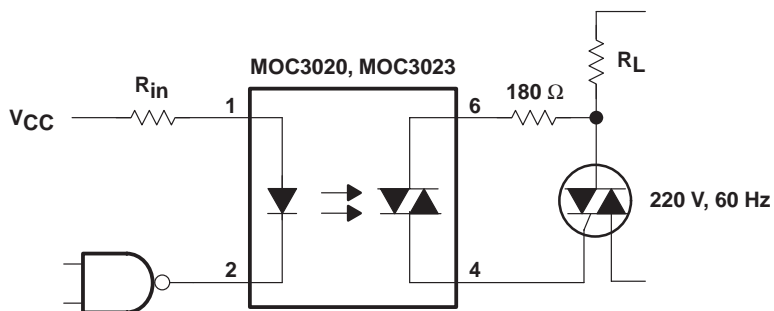

Figure 5. Resistive Load

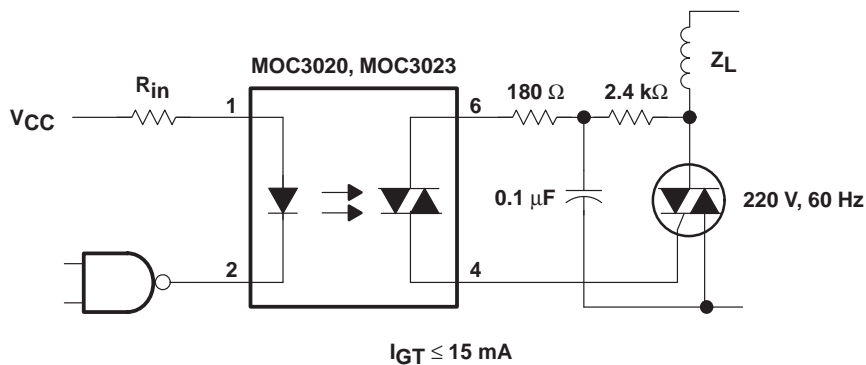

Figure 6. Inductive Load With Sensitive-Gate Triac

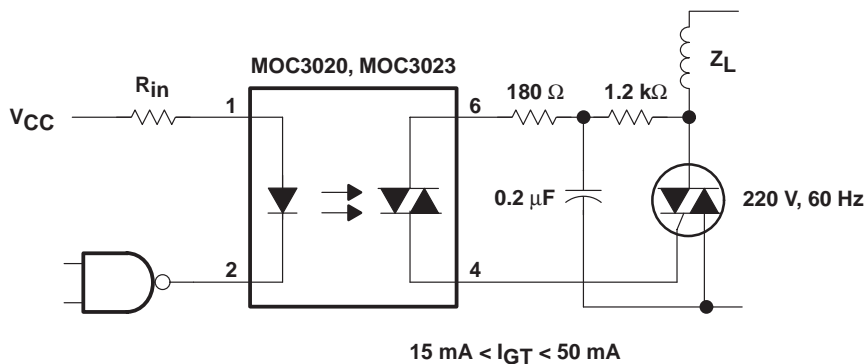
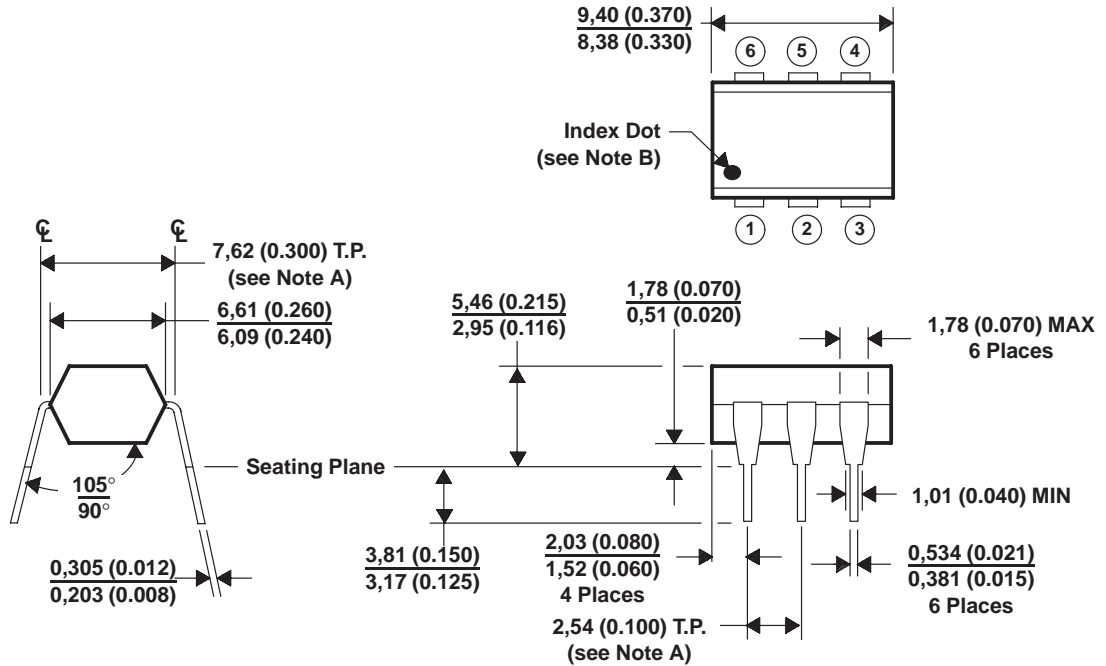

Figure 7. Inductive Load With Nonsensitive-Gate Triac

MECHANICAL INFORMATION

Each device consists of a gallium-arsenide infrared-emitting diode optically coupled to a silicon phototriac mounted on a 6-terminal lead frame encapsulated within an electrically nonconductive plastic compound. The case can withstand soldering temperature with no deformation and device performance characteristics remain stable when operated in high-humidity conditions.



- NOTES: A. Leads are within 0,13 (0.005) radius of true position (T.P.) with maximum material condition and unit installed.  
 B. Pin 1 identified by index dot.  
 C. The dimensions given fall within JEDEC MO-001 AM dimensions.  
 D. All linear dimensions are given in millimeters and parenthetically given in inches.

Figure 8. Packaging Specifications



## **IMPORTANT NOTICE**

Texas Instruments and its subsidiaries (TI) reserve the right to make changes to their products or to discontinue any product or service without notice, and advise customers to obtain the latest version of relevant information to verify, before placing orders, that information being relied on is current and complete. All products are sold subject to the terms and conditions of sale supplied at the time of order acknowledgement, including those pertaining to warranty, patent infringement, and limitation of liability.

TI warrants performance of its semiconductor products to the specifications applicable at the time of sale in accordance with TI's standard warranty. Testing and other quality control techniques are utilized to the extent TI deems necessary to support this warranty. Specific testing of all parameters of each device is not necessarily performed, except those mandated by government requirements.

**CERTAIN APPLICATIONS USING SEMICONDUCTOR PRODUCTS MAY INVOLVE POTENTIAL RISKS OF DEATH, PERSONAL INJURY, OR SEVERE PROPERTY OR ENVIRONMENTAL DAMAGE ("CRITICAL APPLICATIONS"). TI SEMICONDUCTOR PRODUCTS ARE NOT DESIGNED, AUTHORIZED, OR WARRANTED TO BE SUITABLE FOR USE IN LIFE-SUPPORT DEVICES OR SYSTEMS OR OTHER CRITICAL APPLICATIONS. INCLUSION OF TI PRODUCTS IN SUCH APPLICATIONS IS UNDERSTOOD TO BE FULLY AT THE CUSTOMER'S RISK.**

In order to minimize risks associated with the customer's applications, adequate design and operating safeguards must be provided by the customer to minimize inherent or procedural hazards.

TI assumes no liability for applications assistance or customer product design. TI does not warrant or represent that any license, either express or implied, is granted under any patent right, copyright, mask work right, or other intellectual property right of TI covering or relating to any combination, machine, or process in which such semiconductor products or services might be or are used. TI's publication of information regarding any third party's products or services does not constitute TI's approval, warranty or endorsement thereof.