

MSM518221

262,214-Word × 8-Bit Field Memory

DESCRIPTION

The OKI MSM518221 is a high performance 2M bits, 256K×8 bits, Field Memory designed for high-speed serial access applications such as HDTVs, conventional NTSC TVs, VTRs, digital movies and Multi-media systems. The 2M bits capacity fits for one field of conventional NTSC TV screen.

Each of the 8-bits planes has separate serial write and read ports that employ independent control clocks to support asynchronous read and write operations. Different clock rates are also supported that allow alternate data rates between write and read data streams.

The MSM518221 provides high speed FIFO, First-In First-Out, operation without external refreshing: MSM518221 refreshes its DRAM storage cells automatically, so that it appears fully static to the users.

Moreover, fully static type memory cells and decoders for serial access enable the serial access operation refresh free, so that serial read and/or write control clock can be halted high or low for any time as long as the power is on. Internal conflicts of any memory access and refreshing operation are prevented by special arbitration logic.

The MSM518221's function is simple like that of a digital delay device whose delay-bit-length is easily set by reset timing. The delay length, number of read delay clocks between write and read, is determined by externally controlled write and read reset timings.

Additional SRAM serial registers, or line buffers, for the initial access of 256×8 bits enable high speed first-bit-access with no clock delay just after the write or read reset timings.

The MSM518221 is similar in operation and functionality to OKI 1Mbits Field memory MSM514221A besides that MSM518221 has write mask function or input enable function (IE) and read-data skipping function or output enable function (OE). The differences between write enable (WE) and input enable (IE), and between read enable (RE) and output enable (OE) are that WE and RE can stop serial write/read address increments but IE and OE can not stop the increment when write/read clocking is continuously applied to MSM518221.

The input enable (IE) function allows the user to write into selected locations of the memory only leaving the rest of the memory contents unchanged. This facilitate data processing as "picture in picture" on a TV screen simply.

FEATURES

- 512 Rows × 512 Column × 8 bits
- Fast FIFO (First-In First-Out) Operation
- High Speed Asynchronous Serial Access
 - Read/Write Cycle Time 25ns/30ns/40ns
 - Access Time 25ns/25ns/30ns
- Functional Compatibility with OKI MSM514221A
- Write Mask Function (Input Enable Control)
- Data Skipping Function (Output Enable Control)
- Self Refresh (No refresh control is required)
- Package : 28-Pin Plastic SOJ (SOJ 28-P-400)
28-Pin Plastic ZIP (ZIP 28-P-400)

PRODUCT FAMILY

Family	Access Time (Max.)	Cycle Time (Min.)	Package
MSM518221-JS-25	25ns	25ns	400mil28PinSOJ
MSM518221-JS-30	25ns	30ns	400mil28PinSOJ
MSM518221-JS-40	30ns	40ns	400mil28PinSOJ
MSM518221-ZS-25	25ns	25ns	400mil28PinZIP
MSM518221-ZS-30	25ns	30ns	400mil28PinZIP
MSM518221-ZS-40	30ns	40ns	400mil28PinZIP

PIN CONFIGURATION (TOP VIEW)

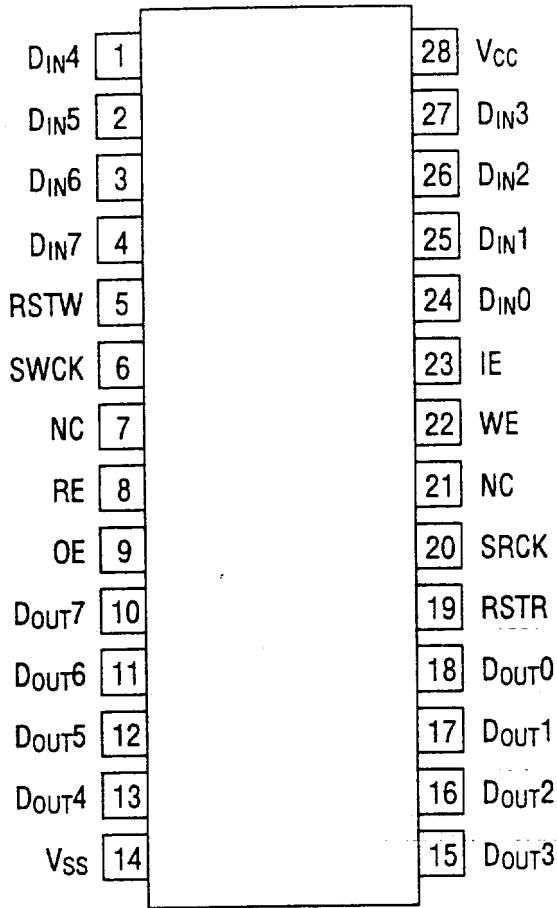

28-PIN SOJ

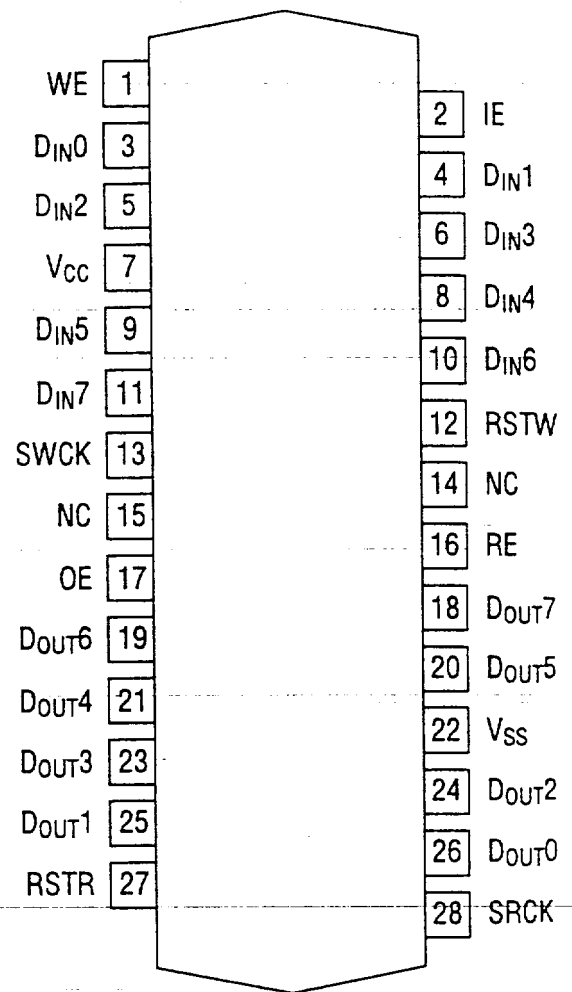

28-PIN ZIP

Pin Name	Function
SRCK	Serial Read Clock
SWCK	Serial Write Clock
WE	Write Enable
RE	Read Enable
IE	Input Enable
OE	Output Enable
RSTW	Write Reset Clock
RSTR	Read Reset Clock
DIN0-7	Data Input
DOUT0-7	Data Output
VCC	Power Supply (5V)
VSS	Ground (0V)
NC	No Connection

FUNCTIONAL BLOCK DIAGRAM

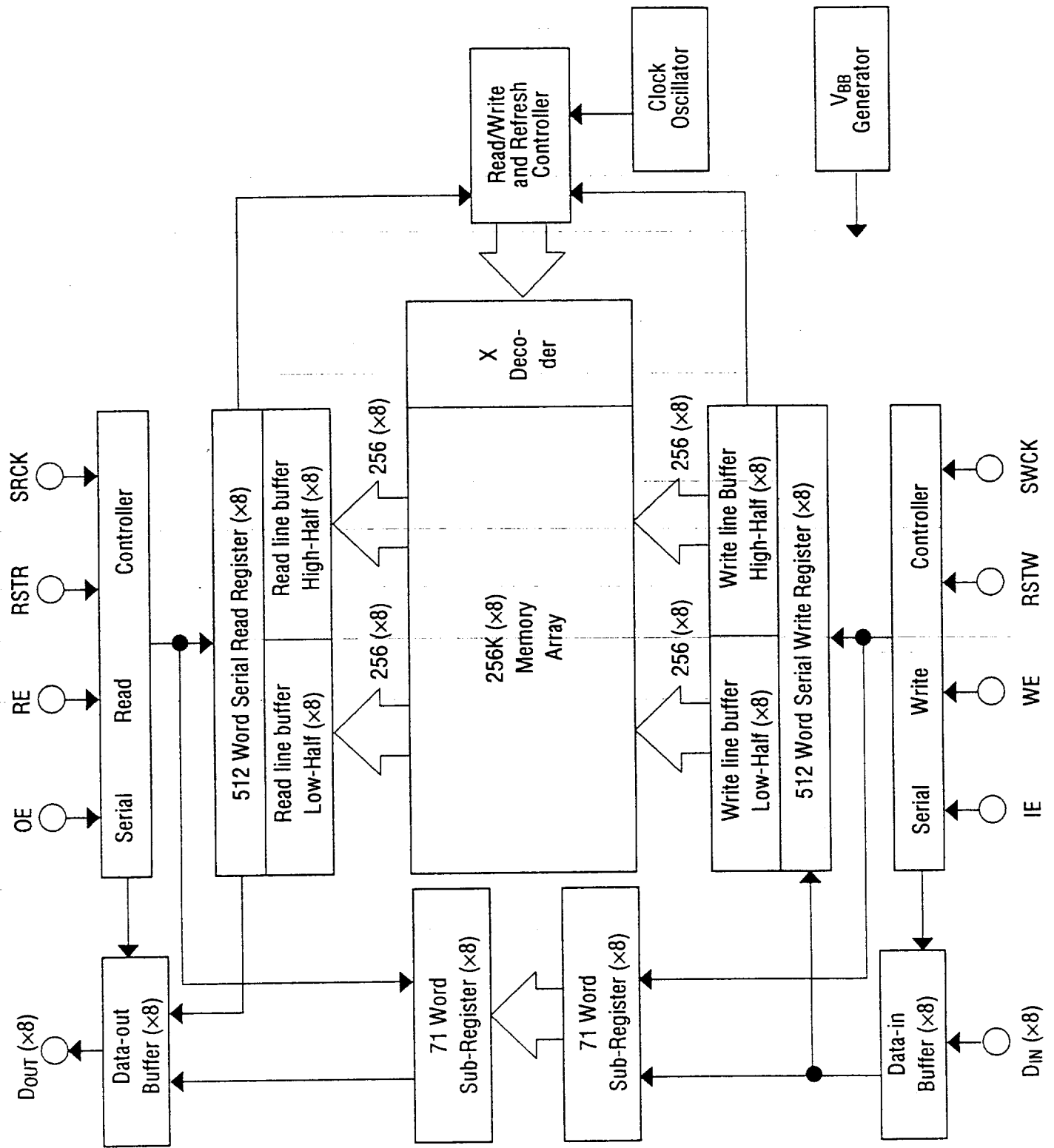

OPERATION

Write Operation

The write operation is controlled by three clocks, SWCK, RSTW, and WE. Write operation is accomplished by cycling SWCK and holding WE high after write address pointer reset operation or RSTW.

Each write operation, which begins after RSTW, must contain at least 80 active write cycles, ie. SWCK cycles while WE is high. To transfer the last data, which at that time are stored in the serial data registers attached to DRAM array, to the DRAM array, an RSTW operation is required after the last SWCK cycle.

Write Reset: RSTW

The first positive transition of SWCK after RSTW going high resets the write address counters to zero. RSTW setup and hold times are referenced to the rising edge of SWCK. Because the write reset function is solely controlled by SWCK rising edge after high level of RSTW, the states of WE and IE are don't care in the write reset cycle.

Before RSTW may be brought high again for a further reset operation, it must have been low for at least two SWCK cycles.

Data Inputs: D_{IN}0-3

Write Clock: SWCK

The SWCK latches the input data on chip when WE is high and also increments the internal write address pointer. Data-in setup time, t_{DS} and hold time, t_{DH} , are referenced to the rising edge of SWCK.

Write Enable: WE

WE is used for data write enable/disable control. WE high level enables the input, and WE low level disables the input and holds the internal write address pointer. There are no WE disable time (low) and WE enable time (high) restrictions because MSM518221 is fully static operation as long as power is on. Note that WE setup and hold times are referenced to the rising edge of SWCK.

Input Enable: IE

IE is used to enable/disable writing into memory. IE high level enables writing. The internal write address pointer is always incremented by cycling SWCK regardless of IE level. Note that IE setup and hold times are referenced to the rising edge of SWCK.

Read Operation

The read operation is controlled by tree clocks, SRCK, RSTR, and RE. Read operation is accomplished by cycling SRCK and holding RE high after read address pointer reset operation or RSTR. Each read operation, which begins after RSTR, must contain at least 80 active read cycles, i.e. SRCK cycles while RE is high.

Read Reset: RSTR

The first positive transition of SRCK after RSTR going high resets the read address counters to zero. RSTR setup and hold times are referenced to the rising edge of SRCK. Because the read reset function is solely controlled by SRCK rising edge after high level of RSTR, the states of RE and RE are don't care in the read reset cycle.

Before RSTR may be brought high again for a further reset operation, it must have been low for at least two SRCK cycles.

Data Out: D_{OUT}0-7

Read Clock: SRCK

Data is shifted out of the data registers triggered by the rising edge of SRCK when RE is high during a read operation. The SRCK input increments the internal read address pointer when RE is high.

The three-state output buffer provides direct TTL compatibility (no pullup resistor required). Data out is the same polarity as data in. The output becomes valid after the access time interval t_{AC} that begins with the rising edge of SRCK. There are no output valid time restriction on MSM518221.

Read Enable: RE

The function of RE is gating of the SRCK clock, for incrementing the read pointer. When RE is high before the rising edge of SRCK, the read pointer is incremented. When RE is low, the read pointer is not incremented. RE setup times (t_{RENS} and t_{RDSS}) and RE hold times (t_{RENH} and t_{RDSh}) are referenced to the rising edge of the SRCK clock.

Output Enable: OE

OE is used to enable/disable the outputs. OE high level enables the outputs. The internal read address pointer is always incremented by cycling SRCK regardless of OE level. Note that OE setup and hold times are referenced to the rising edge of SRCK.

Power-up and Initialization

On Powering up, the device is designed to begin proper operation after at least 100 μ s after V_{CC} has stabilized to a value within the range of recommended operating conditions. After this 100 μ s stabilization interval, the following initialization sequence must be performed.

Because the read and write address counters are not valid after power-up, a minimum of 80 dummy write operations (SWCK cycles) and read operations (SRCK cycles) must be performed, followed by an RSTW operation and an RSTR operation, to properly initialize the write and the read address pointer. Dummy write cycles/RSTW and dummy read cycles/RSTR may occur simultaneously.

If these dummy read and write operations start while V_{CC} and/or the substrate voltage have not stabilized, it is required to perform an RSTR operation plus a minimum of 80 SRCK cycles plus another RSTR operation, and an RSTW operation plus a minimum of 80 SRCK cycles plus another RSTW operation to properly initialize read and write address pointers.

Old/New Data Access

There must be minimum delay of 600 SWCK cycles between writing into memory and reading out from memory if reading from the first field starts with an RSTR operation, before the start of writing the second field, (before the next RSTW operation), then the data just written in will be read out.

The start of reading out the first field of data may be delayed past the beginning of writing in the second field of data for as many as 70 SWCK cycles. If the RSTR operation for the first field read-out occurs less than 70 SWCK cycles after the RSTW operation for the second field write-in, then the internal buffering of the device assures that the first field will still be read out. The first field of data that is read out while the second field of data is written is called "old data".

In order to read out "new data", i.e., the second field written in, the delay between an RSTW operation and an RSTR operation must be at least 600 SRCK cycles. If the delay between RSTW and RSTR operations is more than 71 but less than 600 cycles, then the data read out will be undetermined. It may be "old data" or "new" data or a combination of old and new data. Such a timing should be avoided.

ELECTRICAL CHARACTERISTICS

Absolute Maximum Ratings

Parameter	Symbol	Condition	Rating	Unit
Input Output Voltage	V_T	at $T_a = 25^\circ\text{C}$, V_{SS}	-1.0 to 7.0	V
Output Current	I_{OS}	$T_a = 25^\circ\text{C}$	50	mA
Power Dissipation	P_D	$T_a = 25^\circ\text{C}$	1	W
Operating Temperature	T_{opr}	—	0 to 70	$^\circ\text{C}$
Storage Temperature	T_{stg}	—	-55 to 150	$^\circ\text{C}$

Recommended Operating Conditions

Parameter	Symbol	Condition	Min.	Typ.	Max.	Unit
Power Supply Voltage	V_{CC}	—	4.5	5.0	5.5	V
	V_{SS}	—	0	0	0	V
Input High Voltage	V_{IH}	—	2.4	V_{CC}	$V_{CC}+1$	V
Input Low Voltage	V_{IL}	—	-1.0	0	0.8	V

DC Characteristics

Parameter	Symbol	Condition	Min.	Max.	Unit	
Input Leakage Current	I_{LI}	$0 < V_I < V_{CC}+1$, Other Pins Tested at $V=0V$	-10	10	μA	
Output Leakage Current	I_{LO}	$0 < V_O < V_{CC}$	-10	10	μA	
Output "H" Level Voltage	V_{OH}	$I_{OH} = -1\text{mA}$	2.4	—	V	
Output "L" Level Voltage	V_{OL}	$I_{OL} = 2\text{mA}$	—	0.4	V	
Operating Current	I_{CC1}	Minimum Cycle Time, Output Open	-25	—	60	mA
			-30	—	50	
			-40	—	40	
Standby Current	I_{CC2}	Input Pin= V_{IH} / V_{IL}	—	5	mA	

Capacitance

($T_a=25^\circ\text{C}$, $f=1\text{MHz}$)

Parameter	Symbol	Max.	Unit
Input Capacitance (D_{IN} , SW_{CK} , SR_{CK} , $RSTW$, $RSTR$, WE , RE , IE , OE)	C_I	7	pF
Output Capacitance (D_{OUT})	C_O	7	pF

AC Characteristics (1/2)

(V_{CC} = 5V ± 10%, T_a = 0 to 70°C)

Parameter	Symbol	MSM518221-25		MSM518221-30		MSM518221-40		Unit
		Min.	Max.	Min.	Max.	Min.	Max.	
Access Time from SRCK	t _{AC}	6	25	6	25	6	30	ns
DOUT Hold Time from SRCK	t _{DDCK}	6	—	6	—	6	—	ns
DOUT Enable Time from SRCK	t _{DECK}	6	25	6	25	6	25	ns
SWCK "H" Puls Width	t _{WSWH}	9	—	12	—	17	—	ns
SWCK "L" Puls Width	t _{WSWL}	9	—	12	—	17	—	ns
Input Data Setup Time	t _{DS}	5	—	5	—	5	—	ns
Input Data Hold Time	t _{DH}	6	—	6	—	6	—	ns
WE Enable Setup Time	t _{WENS}	4	—	4	—	4	—	ns
WE Enable Hold Time	t _{WENH}	5	—	5	—	5	—	ns
WE Disable Setup Time	t _{WDSS}	0	—	0	—	0	—	ns
WE Disable Hold Time	t _{WDSH}	5	—	5	—	5	—	ns
IE Enable Setup Time	t _{IENS}	4	—	4	—	4	—	ns
IE Enable Hold Time	t _{IENH}	5	—	5	—	5	—	ns
IE Disable Setup Time	t _{IDSS}	0	—	0	—	0	—	ns
IE Disable Hold Time	t _{IDSH}	5	—	5	—	5	—	ns
WE "H" Puls Width	t _{WWEH}	5	—	10	—	10	—	ns
WE "L" Puls Width	t _{WWEL}	5	—	10	—	10	—	ns
IE "H" Puls Width	t _{WIEH}	5	—	10	—	10	—	ns
IE "L" Puls Width	t _{WIEL}	5	—	10	—	10	—	ns
RSTW Setup Time	t _{RSTWS}	0	—	0	—	0	—	ns
RSTW Hold Time	t _{RSTWH}	10	—	10	—	10	—	ns
SRCK "H" Puls Width	t _{WSRH}	9	—	12	—	17	—	ns
SRCK "L" Puls Width	t _{WSRL}	9	—	12	—	17	—	ns
RE Enable Setup Time	t _{RENS}	0	—	0	—	0	—	ns
RE Enable Hold Time	t _{RENH}	5	—	5	—	5	—	ns
RE Disable Setup Time	t _{RDSS}	0	—	0	—	0	—	ns
RE Disable Hold Time	t _{RDSH}	5	—	5	—	5	—	ns
OE Enable Setup Time	t _{OENS}	0	—	0	—	0	—	ns
OE Enable Hold Time	t _{OENH}	5	—	5	—	5	—	ns
OE Disable Setup Time	t _{ODSS}	0	—	0	—	0	—	ns
OE Disable Hold Time	t _{ODSH}	5	—	5	—	5	—	ns
Output Buffer Turn-off Delay from OE	t _{OEZ}	17	—	17	—	17	—	ns
RE "H" Puls Width	t _{WREH}	5	—	10	—	10	—	ns
RE "L" Puls Width	t _{WREL}	5	—	10	—	10	—	ns
OE "H" Puls Width	t _{WOEH}	5	—	10	—	10	—	ns
OE "L" Puls Width	t _{WOEL}	5	—	10	—	10	—	ns
RSTR Setup Time	t _{RSTRS}	0	—	0	—	0	—	ns
RSTR Hold Time	t _{RSTRH}	10	—	10	—	10	—	ns
SWCK Cycle Time	t _{SWC}	25	—	30	—	40	—	ns

AC Characteristics (2/2)

($V_{CC} = 5V \pm 10\%$, $T_a = 0$ to 70°C)

Parameter	Symbol	MSM518221-25		MSM518221-30		MSM518221-40		Unit
		Min.	Max.	Min.	Max.	Min.	Max.	
SRCK Cycle Time	t_{SRC}	25	—	30	—	40	—	ns
Trandition Time (Rise and Fall)	t_T	3	30	3	30	3	30	ns

Notes: 1. Input signal reference levels for the parameter measurement are $V_{IH}=3.0V$ and $V_{IL}=0V$. The transition time t_T is defined to be a transition time that signal transfers between $V_{IH}=3.0V$ and $V_{IL}=0V$.

2. AC measurements assume $t_T=3ns$.
3. Read address must have more than 600 address delay than write address in every cycle when asynchronous read/write is performed.
4. Read must have more than 600 address delay than write in order to read the data written in a current series of write cycle which has been started last write reset cycle: this is called "new data read".

When read has less than 70 address delay than write, the read data are the data written in a previous series of write cycle which had been written before last write reset cycle: this is called "old data read".

5. When the read address delay is between more than 71 and less than 599, read data will be undetermined. However, normal write is achieved in this address condition.
6. Outputs are measured with a load equivalent to 1 TTL load and 30 pF. Output reference levels are $V_{OH}=2.4V$ and $V_{OL}=0.8V$.

TIMING WAVEFORM

Write Cycle Timing (Write Reset)

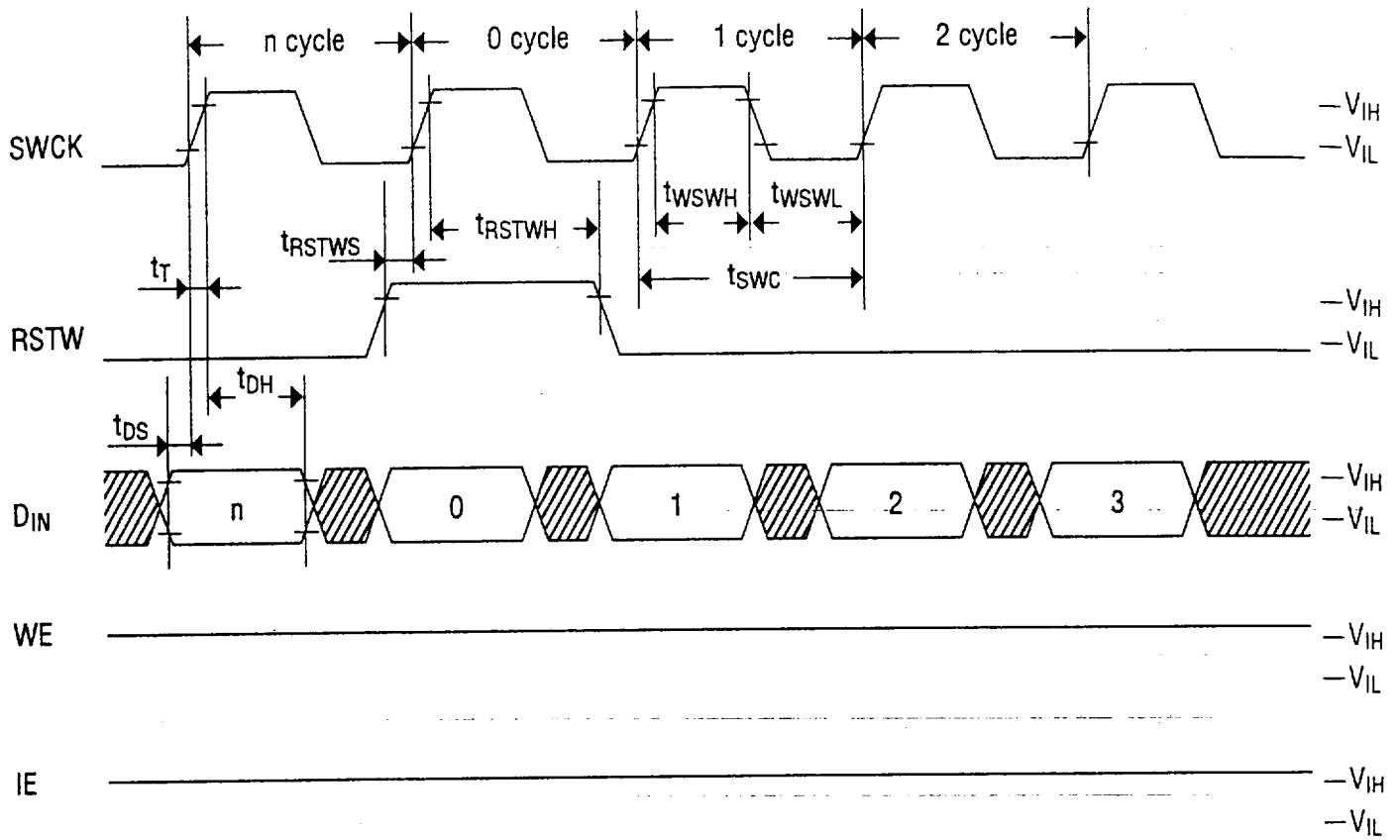

Write Cycle Timing (Write Enable)

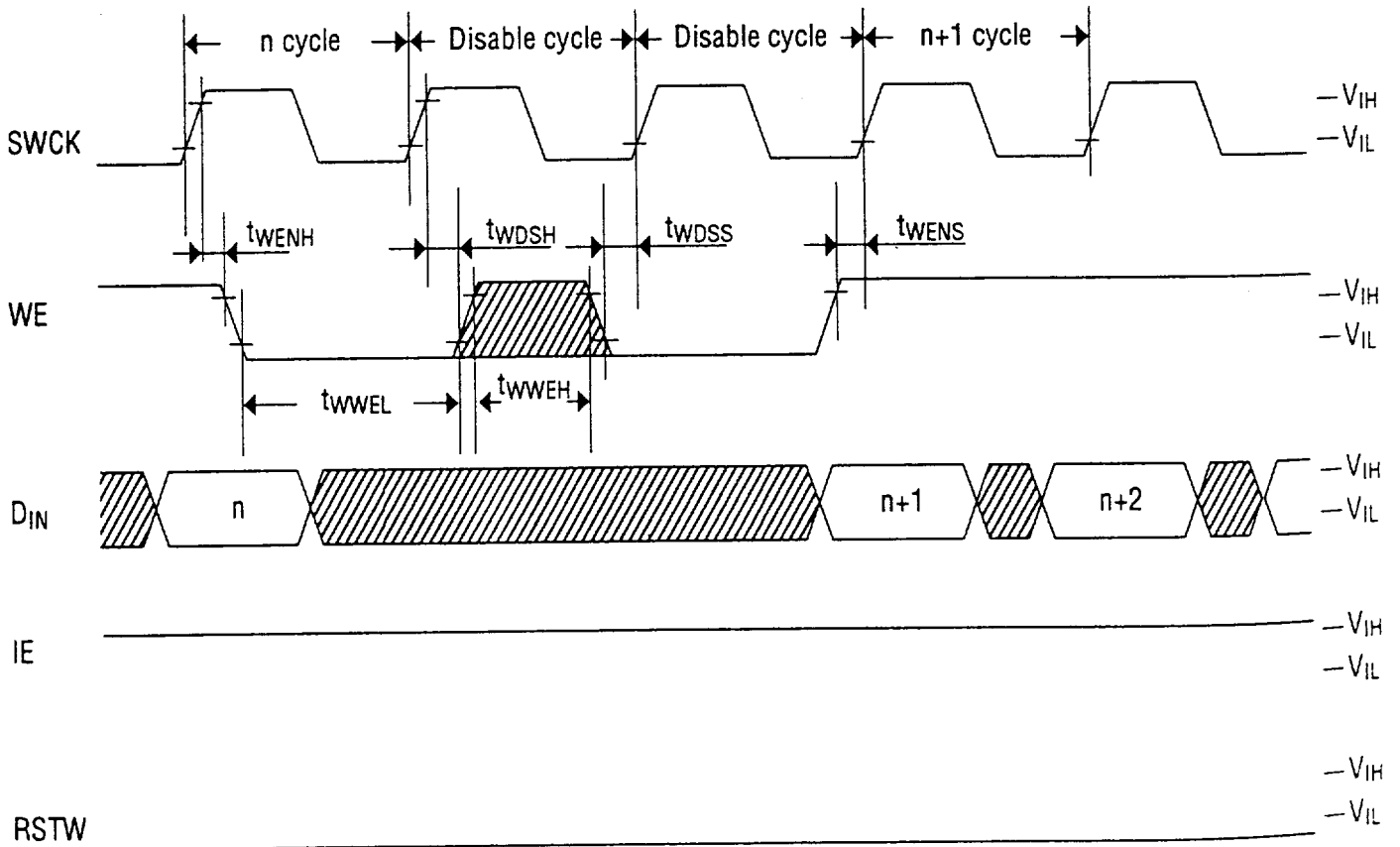

Write Cycle Timing (Input Enable)

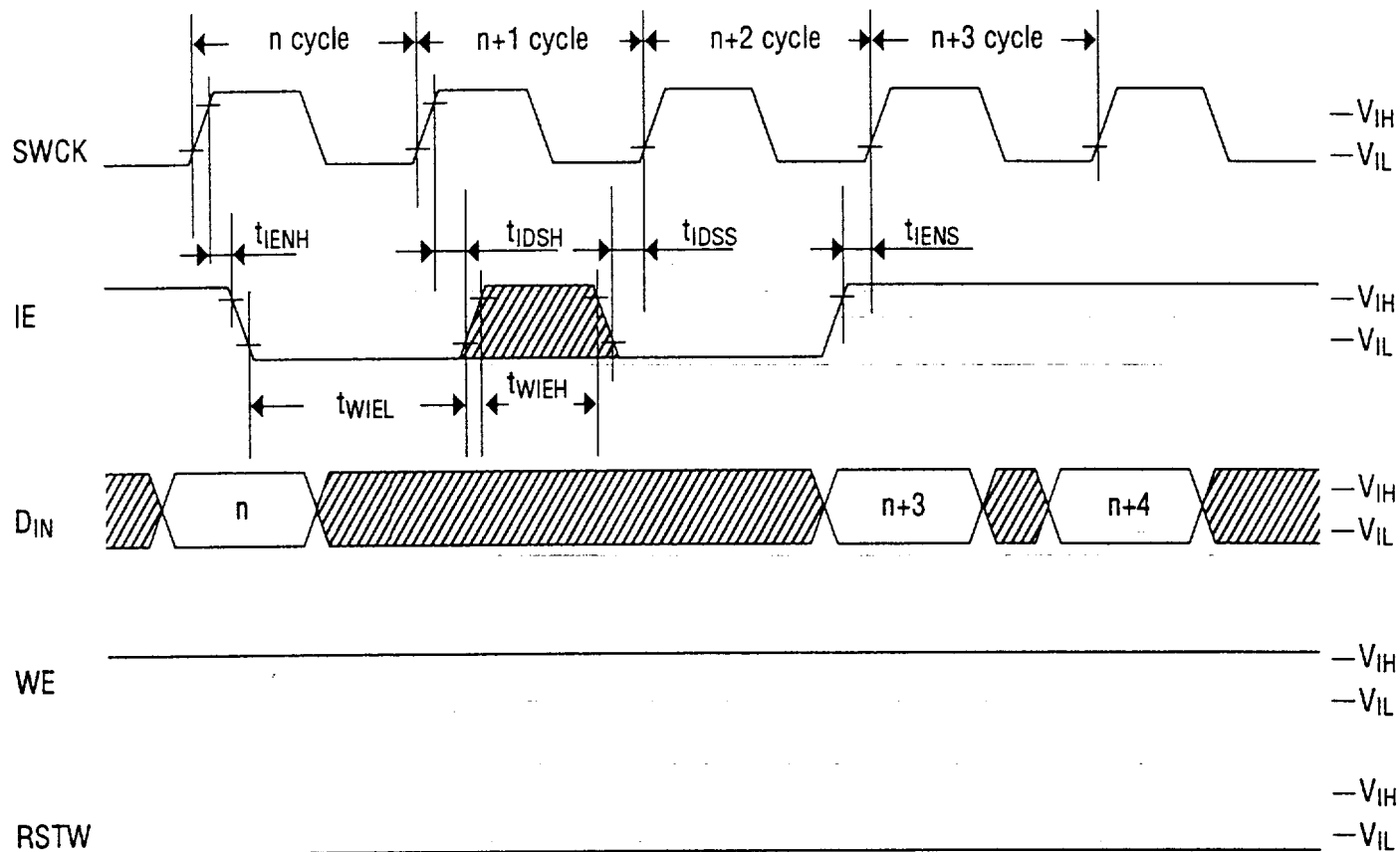

Read Cycle Timing (Read Reset)

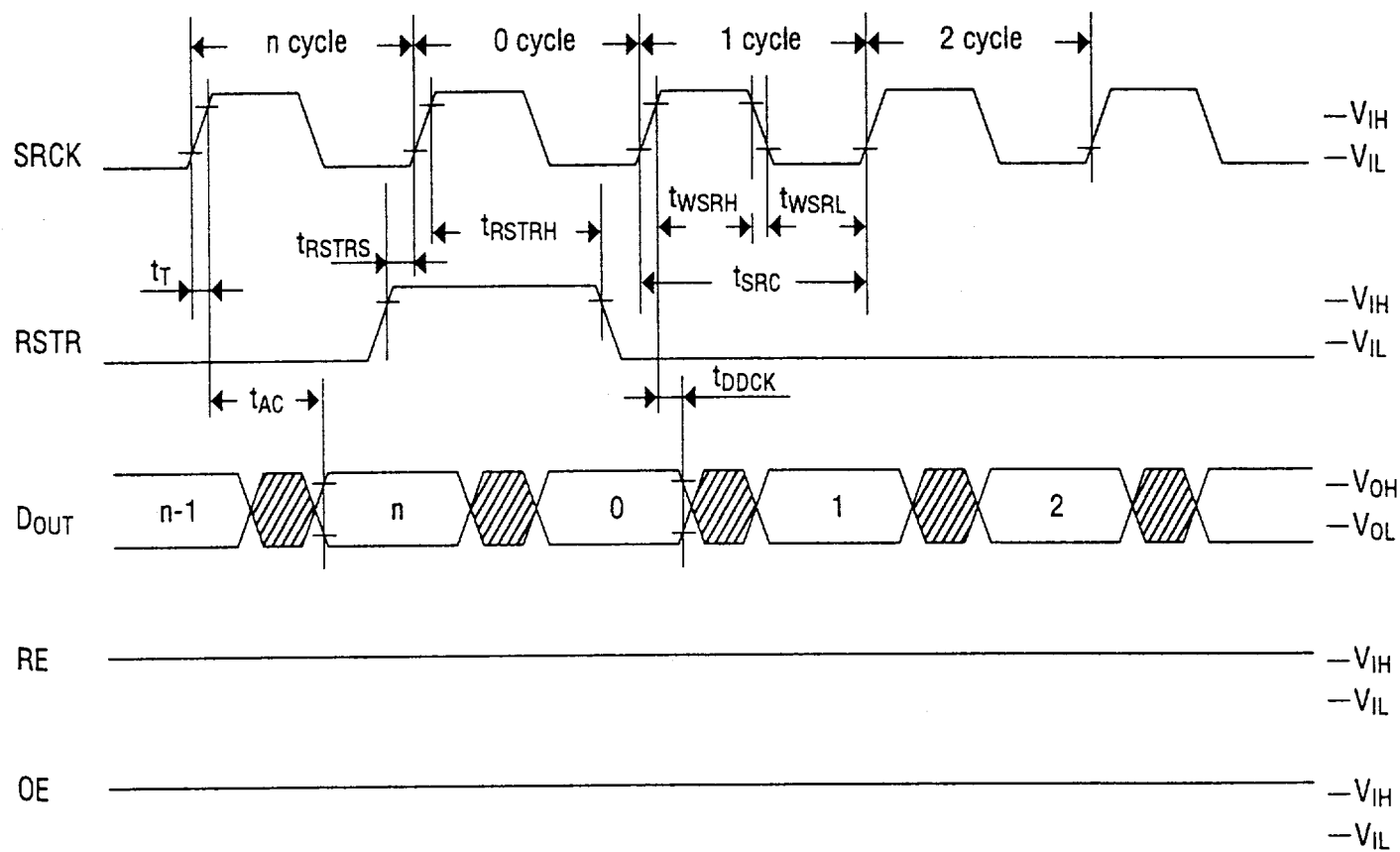

Read Cycle Timing (Read Enable)

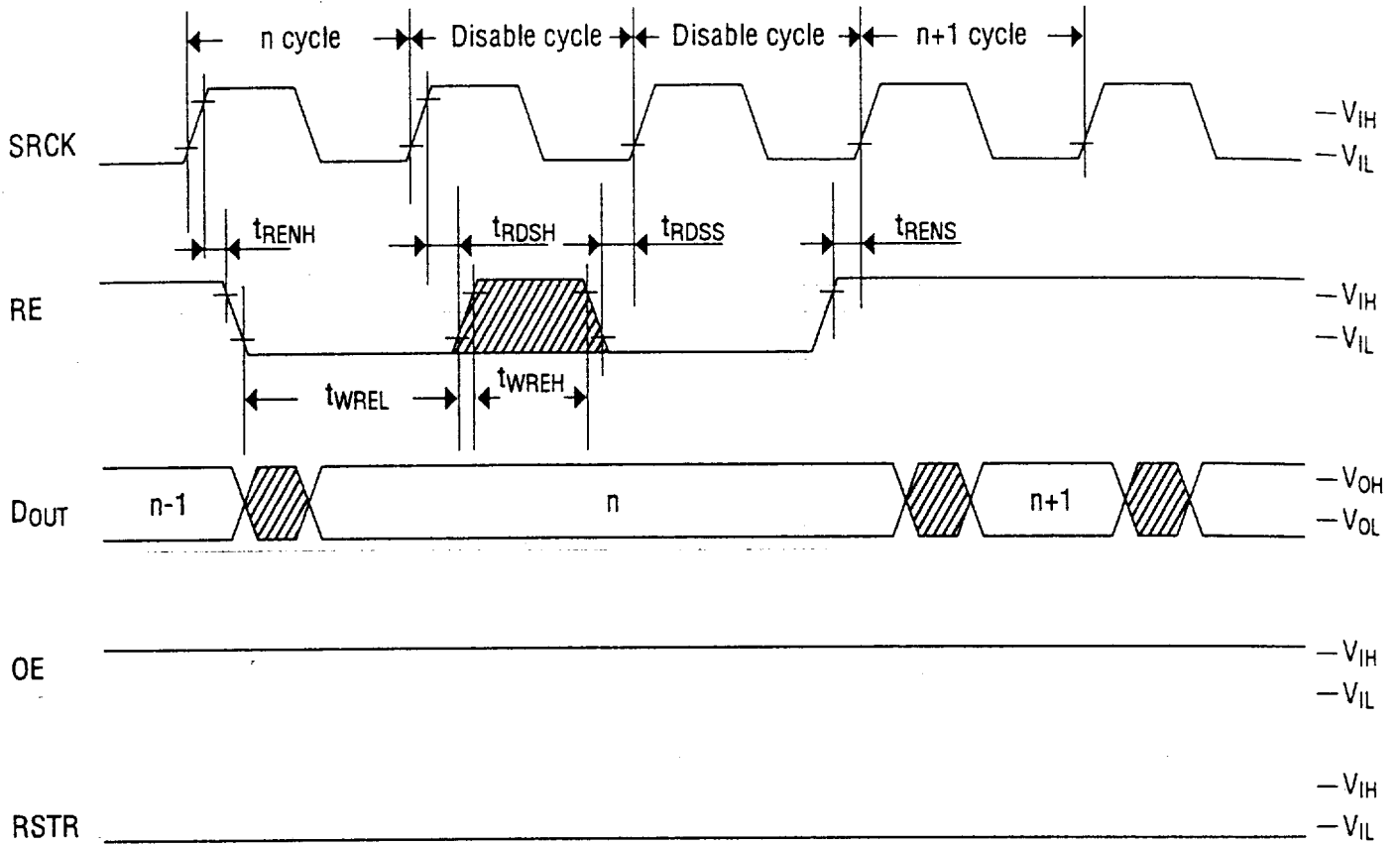

Read Cycle Timing (Output Enable)

