



TS912

RAIL TO RAIL CMOS DUAL OPERATIONAL AMPLIFIER

- RAIL TO RAIL INPUT AND OUTPUT VOLTAGE RANGES
- SINGLE (OR DUAL) SUPPLY OPERATION FROM 2.7V TO 16V
- EXTREMELY LOW INPUT BIAS CURRENT : 1pA typ
- LOW INPUT OFFSET VOLTAGE : 2mV max.
- SPECIFIED FOR 600Ω AND 100Ω LOADS
- LOW SUPPLY CURRENT : 200μA/Ampli ($V_{CC} = 3V$)
- LATCH-UP IMMUNITY
- ESD TOLERANCE : 3KV
- SPICE MACROMODEL INCLUDED IN THIS-SPECIFICATION

DESCRIPTION

The TS912 is a RAIL TO RAIL CMOS dual operational amplifier designed to operate with a single or dual supply voltage.

The input voltage range V_{icm} includes the two supply rails V_{CC}^+ and V_{CC}^- .

At 3V, the output reaches :

- $V_{CC}^- + 30mV$ $V_{CC}^+ - 40mV$ with $R_L = 10k\Omega$
- $V_{CC}^- + 300mV$ $V_{CC}^+ - 400mV$ with $R_L = 600\Omega$

This product offers a broad supply voltage operating range from 2.7V to 16V and a supply current of only 200μA/amp @ $V_{CC} = 3V$.

Source and sink output current capability is typically 40mA at $V_{CC} = 3V$, fixed by an internal limitation circuit.

ORDER CODE

| Part Number | Temperature Range | Package | |
|--------------|-------------------|---------|---|
| | | N | D |
| TS912I/AI/BI | -40, +125°C | • | • |

N = Dual in Line Package (DIP)
D = Small Outline Package (SO) - also available in Tape & Reel (DT)

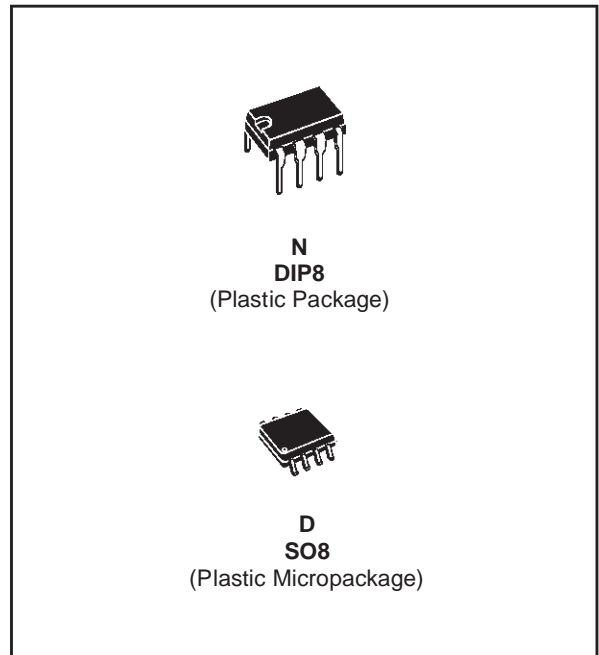

PIN CONNECTIONS (top view)

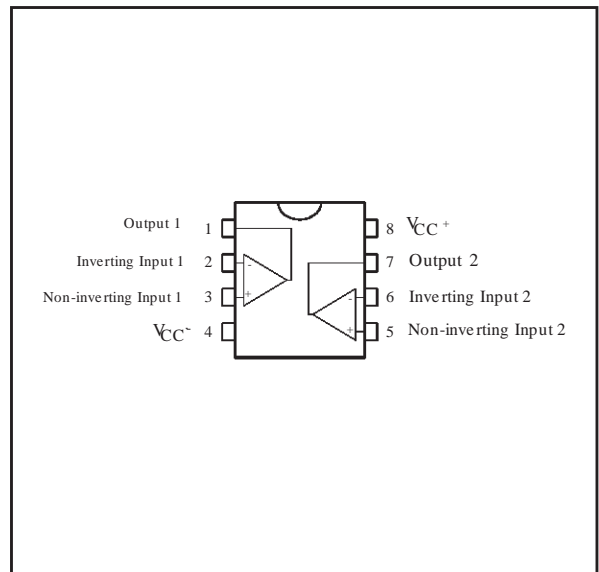

TS912

SCHEMATIC DIAGRAM (1/2 TS912)

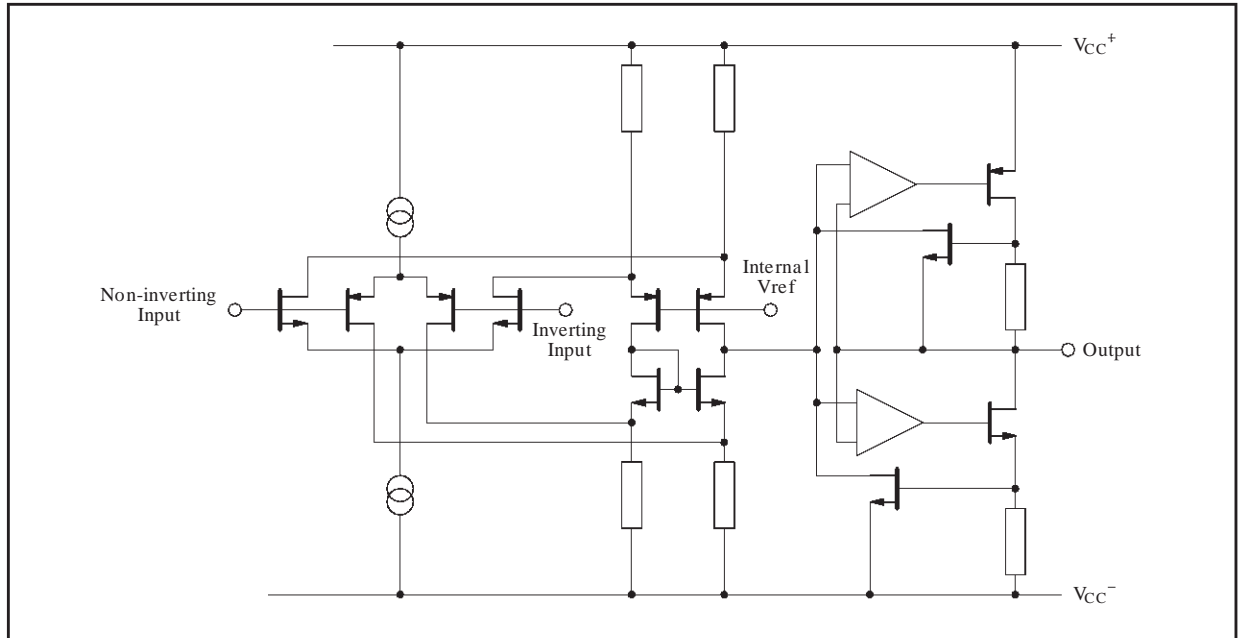

ABSOLUTE MAXIMUM RATINGS

| Symbol | Parameter | Value | Unit |
|------------|---|--------------|--------------------|
| V_{CC} | Supply voltage ¹⁾ | 18 | V |
| V_{id} | Differential Input Voltage ²⁾ | ± 18 | V |
| V_i | Input Voltage ³⁾ | -0.3 to 18 | V |
| I_{in} | Current on Inputs | ± 50 | mA |
| I_o | Current on Outputs | ± 130 | mA |
| T_{oper} | Operating Free Air Temperature Range TS912/AI/BI | -40 to + 125 | $^{\circ}\text{C}$ |
| T_{stg} | Storage Temperature | -65 to +150 | $^{\circ}\text{C}$ |

1. All voltages values, except differential voltage are with respect to network ground terminal.
2. Differential voltages are non-inverting input terminal with respect to the inverting input terminal.
3. The magnitude of input and output voltages must never exceed $V_{CC}^{+} + 0.3\text{V}$.

OPERATING CONDITIONS

| Symbol | Parameter | Value | Unit |
|-----------|---------------------------------|--|------|
| V_{CC} | Supply voltage | 2.7 to 16 | V |
| V_{icm} | Common Mode Input Voltage Range | $V_{CC}^{-} - 0.2$ to $V_{CC}^{+} + 0.2$ | V |

ELECTRICAL CHARACTERISTICS
 $V_{CC^+} = 3V$, $V_{CC^-} = 0V$, R_L , C_L connected to $V_{CC/2}$, $T_{amb} = 25^\circ C$ (unless otherwise specified)

| Symbol | Parameter | Min. | Typ. | Max. | Unit |
|-----------------|---|---|------------------|------------------------------|------------------|
| V_{io} | Input Offset Voltage ($V_{ic} = V_o = V_{CC/2}$) $T_{min.} \leq T_{amb} \leq T_{max.}$ | | | 10 5 2 12 7 3 | mV |
| ΔV_{io} | Input Offset Voltage Drift | | 5 | | $\mu V/^\circ C$ |
| I_{io} | Input Offset Current ¹⁾ $T_{min.} \leq T_{amb} \leq T_{max.}$ | | 1 | 100 200 | pA |
| I_{ib} | Input Bias Current ¹⁾ $T_{min.} \leq T_{amb} \leq T_{max.}$ | | 1 | 150 300 | pA |
| I_{CC} | Supply Current (per amplifier, $A_{VCL} = 1$, no load) $T_{min.} \leq T_{amb} \leq T_{max.}$ | | 200 | 300 400 | μA |
| CMR | Common Mode Rejection Ratio $V_{ic} = 0$ to $3V$, $V_o = 1.5V$ | | 70 | | dB |
| SVR | Supply Voltage Rejection Ratio ($V_{CC^+} = 2.7$ to $3.3V$, $V_o = V_{CC/2}$) | 50 | 80 | | dB |
| A_{vd} | Large Signal Voltage Gain ($R_L = 10k\Omega$, $V_o = 1.2V$ to $1.8V$) $T_{min.} \leq T_{amb} \leq T_{max.}$ | 3 2 | 10 | | V/mV |
| V_{OH} | High Level Output Voltage ($V_{id} = 1V$) $T_{min.} \leq T_{amb} \leq T_{max.}$ | $R_L = 100k\Omega$ 2.95 $R_L = 10k\Omega$ 2.9 $R_L = 600\Omega$ 2.3 $R_L = 100\Omega$ | 2.96 2.6 2 | | V |
| V_{OL} | Low Level Output Voltage ($V_{id} = -1V$) $T_{min.} \leq T_{amb} \leq T_{max.}$ | $R_L = 100k\Omega$ $R_L = 10k\Omega$ $R_L = 600\Omega$ $R_L = 100\Omega$ | 30 300 900 | 50 70 400 | mV |
| I_o | Output Short Circuit Current ($V_{id} = \pm 1V$) Source ($V_o = V_{CC^-}$) Sink ($V_o = V_{CC^+}$) | 20 20 | 40 40 | | mA |
| GBP | Gain Bandwidth Product ($A_{VCL} = 100$, $R_L = 10k\Omega$, $C_L = 100pF$, $f = 100kHz$) | | 0.8 | | MHz |
| SR ⁺ | Slew Rate ($A_{VCL} = 1$, $R_L = 10k\Omega$, $C_L = 100pF$, $V_i = 1.3V$ to $1.7V$) | | 0.4 | | V/ μs |
| SR ⁻ | Slew Rate ($A_{VCL} = 1$, $R_L = 10k\Omega$, $C_L = 100pF$, $V_i = 1.3V$ to $1.7V$) | | 0.3 | | V/ μs |
| ϕ_m | Phase Margin | | 30 | | Degrees |
| en | Equivalent Input Noise Voltage ($R_s = 100\Omega$, $f = 1kHz$) | | 30 | | nV/ \sqrt{Hz} |

1. Maximum values including unavoidable inaccuracies of the industrial test

TS912

ELECTRICAL CHARACTERISTICS

$V_{CC^+} = 5V$, $V_{CC^-} = 0V$, R_L , C_L connected to $V_{CC/2}$, $T_{amb} = 25^\circ C$ (unless otherwise specified)

| Symbol | Parameter | Min. | Typ. | Max. | Unit |
|-----------------|---|--|---------------------------------|------------------------------|------------------|
| V_{io} | Input Offset Voltage ($V_{ic} = V_o = V_{CC/2}$) $T_{min.} \leq T_{amb} \leq T_{max.}$ | | | 10 5 2 12 7 3 | mV |
| ΔV_{io} | Input Offset Voltage Drift | | 5 | | $\mu V/^\circ C$ |
| I_{io} | Input Offset Current ¹⁾ $T_{min.} \leq T_{amb} \leq T_{max.}$ | | 1 | 100 200 | pA |
| I_{ib} | Input Bias Current ¹⁾ $T_{min.} \leq T_{amb} \leq T_{max.}$ | | 1 | 150 300 | pA |
| I_{CC} | Supply Current (per amplifier, $A_{VCL} = 1$, no load) $T_{min.} \leq T_{amb} \leq T_{max.}$ | | 230 | 350 450 | μA |
| CMR | Common Mode Rejection Ratio $V_{ic} = 1.5$ to $3.5V$, $V_o = 2.5V$ | 60 | 85 | | dB |
| SVR | Supply Voltage Rejection Ratio ($V_{CC^+} = 3$ to $5V$, $V_o = V_{CC/2}$) | 55 | 80 | | dB |
| A_{vd} | Large Signal Voltage Gain ($R_L = 10k\Omega$, $V_o = 1.5V$ to $3.5V$) $T_{min.} \leq T_{amb} \leq T_{max.}$ | 10 7 | 40 | | V/mV |
| V_{OH} | High Level Output Voltage ($V_{id} = 1V$) $T_{min.} \leq T_{amb} \leq T_{max.}$ | $R_L = 100k\Omega$ 4.95 $R_L = 10k\Omega$ 4.9 $R_L = 600\Omega$ 4.25 $R_L = 100\Omega$ 4.8 $R_L = 10k\Omega$ 4.1 $R_L = 600\Omega$ | 4.95 4.55 3.7 | | V |
| V_{OL} | Low Level Output Voltage ($V_{id} = -1V$) $T_{min.} \leq T_{amb} \leq T_{max.}$ | $R_L = 100k\Omega$ $R_L = 10k\Omega$ $R_L = 600\Omega$ $R_L = 100\Omega$ $R_L = 10k\Omega$ $R_L = 600\Omega$ | 40 350 1400 150 750 | 50 100 500 | mV |
| I_o | Output Short Circuit Current ($V_{id} = \pm 1V$) Source ($V_o = V_{CC^-}$) Sink ($V_o = V_{CC^+}$) | 45 45 | 65 65 | | mA |
| GBP | Gain Bandwidth Product ($A_{VCL} = 100$, $R_L = 10k\Omega$, $C_L = 100pF$, $f = 100kHz$) | | 1 | | MHz |
| SR^+ | Slew Rate ($A_{VCL} = 1$, $R_L = 10k\Omega$, $C_L = 100pF$, $V_i = 1V$ to $4V$) | | 0.8 | | |
| SR^- | Slew Rate ($A_{VCL} = 1$, $R_L = 10k\Omega$, $C_L = 100pF$, $V_i = 1V$ to $4V$) | | 0.6 | | V/ μs |
| en | Equivalent Input Noise Voltage ($R_s = 100\Omega$, $f = 1kHz$) | | 30 | | nV/ \sqrt{Hz} |
| V_{O1}/V_{O2} | Channel Separation ($f = 1kHz$) | | 120 | | dB |
| ϕm | Phase Margin | | 30 | | Degrees |

1. Maximum values including unavoidable inaccuracies of the industrial test

ELECTRICAL CHARACTERISTICS
 $V_{CC^+} = 10V$, $V_{CC^-} = 0V$, R_L , C_L connected to $V_{CC/2}$, $T_{amb} = 25^\circ C$ (unless otherwise specified)

| Symbol | Parameter | Min. | Typ. | Max. | Unit |
|-------------------|--|--------------------|------|------|------------------|
| V_{io} | Input Offset Voltage ($V_{ic} = V_o = V_{CC/2}$) $T_{min.} \leq T_{amb} \leq T_{max.}$ | TS912 | | 10 | mV |
| | | TS912A | | 5 | |
| | | TS912B | | 2 | |
| | | TS912 | | 12 | |
| | | TS912A | | 7 | |
| TS912B | | 3 | | | |
| ΔV_{io} | Input Offset Voltage Drift | | 5 | | $\mu V/^\circ C$ |
| I_{io} | Input Offset Current ¹⁾ $T_{min.} \leq T_{amb} \leq T_{max.}$ | | 1 | 100 | pA |
| | | | | 200 | |
| I_{ib} | Input Bias Current ¹⁾ $T_{min.} \leq T_{amb} \leq T_{max.}$ | | 1 | 150 | pA |
| | | | | 300 | |
| I_{CC} | Supply Current (per amplifier, $A_{VCL} = 1$, no load) $T_{min.} \leq T_{amb} \leq T_{max.}$ | | 400 | 600 | μA |
| | | | | 700 | |
| CMR | Common Mode Rejection Ratio $V_{ic} = 3$ to $7V$, $V_o = 5V$ $V_{ic} = 0$ to $10V$, $V_o = 5V$ | 60 | 90 | | dB |
| | | 50 | 75 | | |
| SVR | Supply Voltage Rejection Ratio ($V_{CC^+} = 5$ to $10V$, $V_o = V_{CC/2}$) | 60 | 90 | | dB |
| A_{vd} | Large Signal Voltage Gain ($R_L = 10k\Omega$, $V_o = 2.5V$ to $7.5V$) $T_{min.} \leq T_{amb} \leq T_{max.}$ | 15 | 50 | | V/mV |
| | | 10 | | | |
| V_{OH} | High Level Output Voltage ($V_{id} = 1V$) $T_{min.} \leq T_{amb} \leq T_{max.}$ | $R_L = 100k\Omega$ | 9.95 | | V |
| | | $R_L = 10k\Omega$ | 9.85 | 9.95 | |
| | | $R_L = 600\Omega$ | 9 | 9.35 | |
| | | $R_L = 100\Omega$ | | 7.8 | |
| | | $R_L = 10k\Omega$ | 9.8 | | |
| $R_L = 600\Omega$ | 8.8 | | | | |
| V_{OL} | Low Level Output Voltage ($V_{id} = -1V$) $T_{min.} \leq T_{amb} \leq T_{max.}$ | $R_L = 100k\Omega$ | | 50 | mV |
| | | $R_L = 10k\Omega$ | | 150 | |
| | | $R_L = 600\Omega$ | | 800 | |
| | | $R_L = 100\Omega$ | | 2300 | |
| | | $R_L = 10k\Omega$ | | 150 | |
| $R_L = 600\Omega$ | | 900 | | | |
| I_o | Output Short Circuit Current ($V_{id} = \pm 1V$) Source ($V_o = V_{CC^-}$) Sink ($V_o = V_{CC^+}$) | 45 | 65 | | mA |
| | | 50 | 75 | | |
| GBP | Gain Bandwidth Product ($A_{VCL} = 100$, $R_L = 10k\Omega$, $C_L = 100pF$, $f = 100kHz$) | | 1.4 | | MHz |
| SR^+ | Slew Rate ($A_{VCL} = 1$, $R_L = 10k\Omega$, $C_L = 100pF$, $V_i = 2.5V$ to $7.5V$) | | 1.3 | | V/ μs |
| SR^- | Slew Rate ($A_{VCL} = 1$, $R_L = 10k\Omega$, $C_L = 100pF$, $V_i = 2.5V$ to $7.5V$) | | 0.8 | | |
| ϕ_m | Phase Margin | | 40 | | Degrees |
| en | Equivalent Input Noise Voltage ($R_s = 100\Omega$, $f = 1kHz$) | | 30 | | nV/ \sqrt{Hz} |
| THD | Total Harmonic Distortion ($A_{VCL} = 1$, $R_L = 10k\Omega$, $C_L = 100pF$, $V_o = 4.75V$ to $5.25V$, $f = 1kHz$) | | 0.02 | | % |
| C_{in} | Input Capacitance | | 1.5 | | pF |

1. Maximum values including unavoidable inaccuracies of the industrial test

TYPICAL CHARACTERISTICS

Figure 1 : Supply Current (each amplifier) vs Supply Voltage

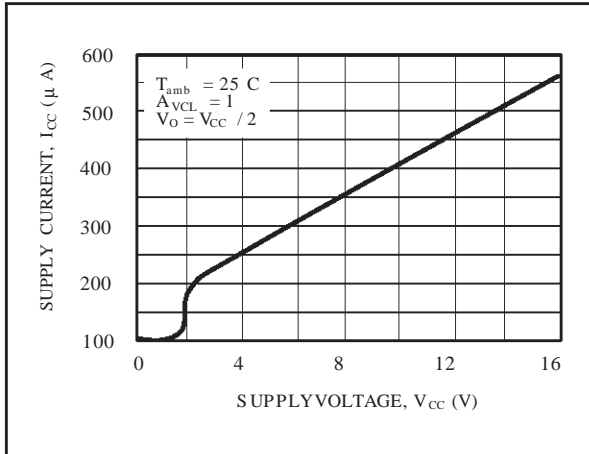

Figure 2 : Input Bias Current vs Temperature

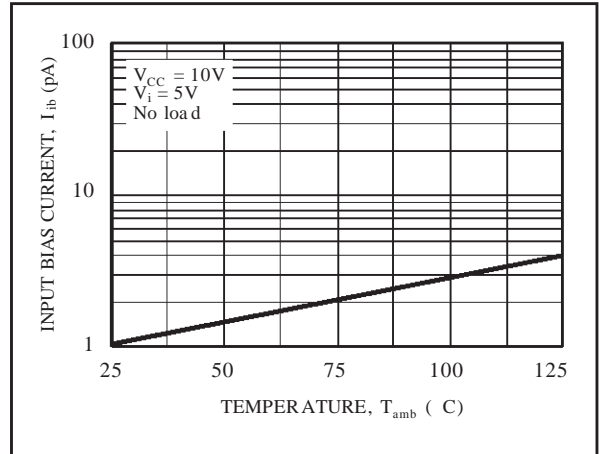

Figure 3a : High Level Output Voltage vs High Level Output Current

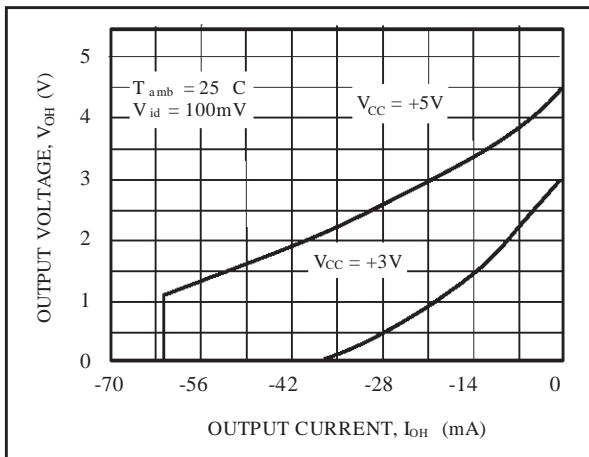

Figure 3b : High Level Output Voltage vs High Level Output Current

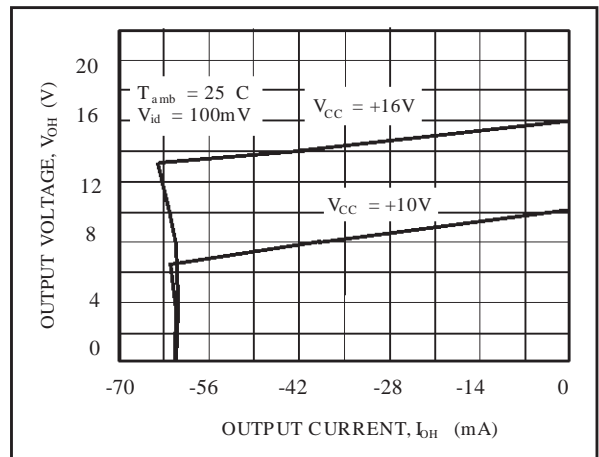

Figure 4a : Low Level Output Voltage vs Low Level Output Current

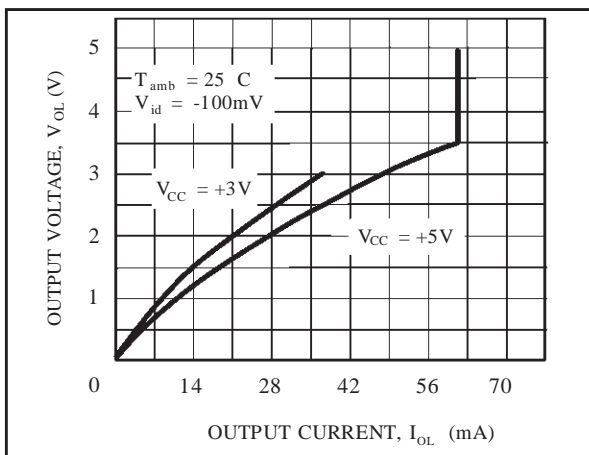

Figure 4b : Low Level Output Voltage vs Low Level Output Current

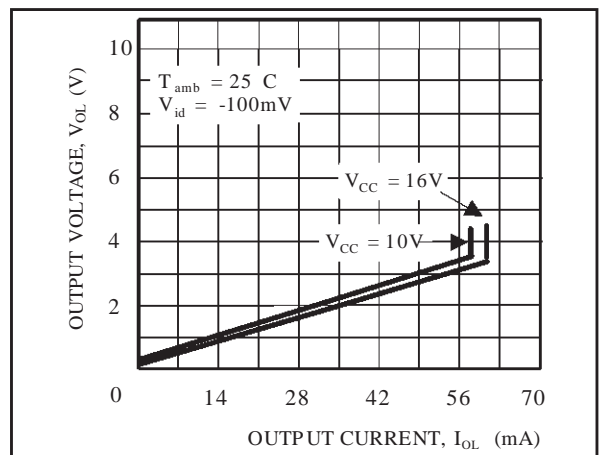

Figure 5a : Gain and Phase vs Frequency

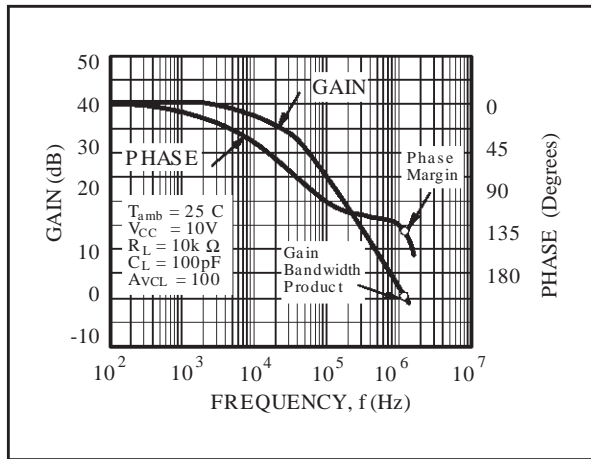

Figure 5b : Gain and Phase vs Frequency

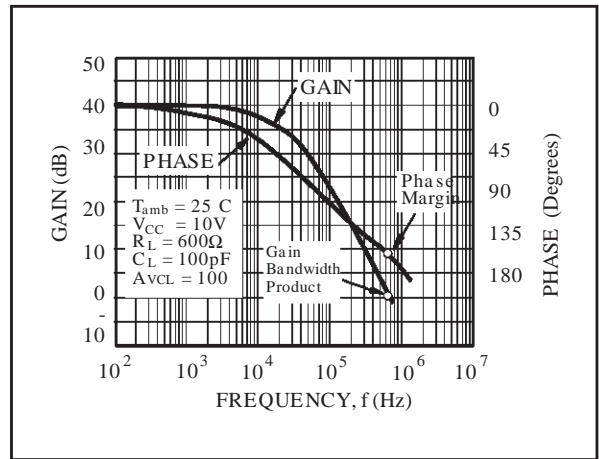

Figure 6a : Gain Bandwidth Product vs Supply Voltage

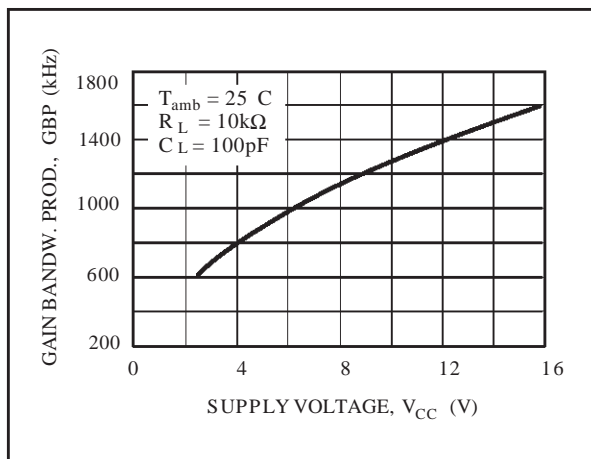

Figure 6b : Gain Bandwidth Product vs Supply Voltage

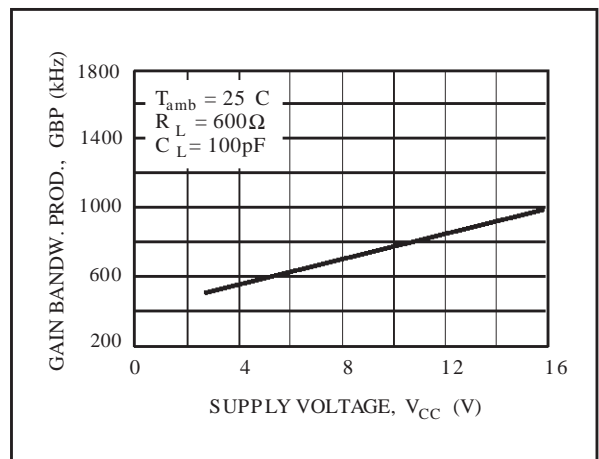

Figure 7a : Phase Margin vs Supply Voltage

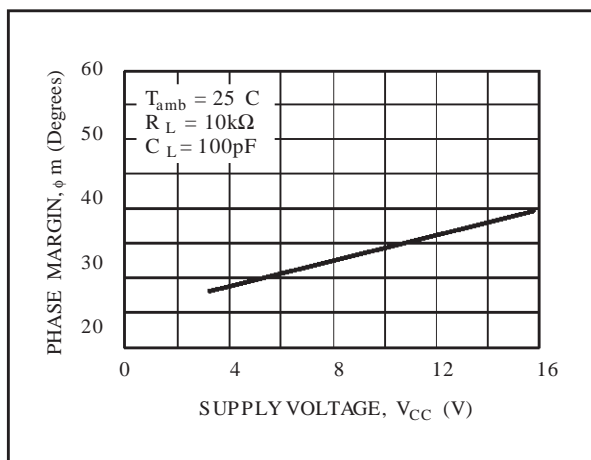

Figure 7b : Phase Margin vs Supply Voltage

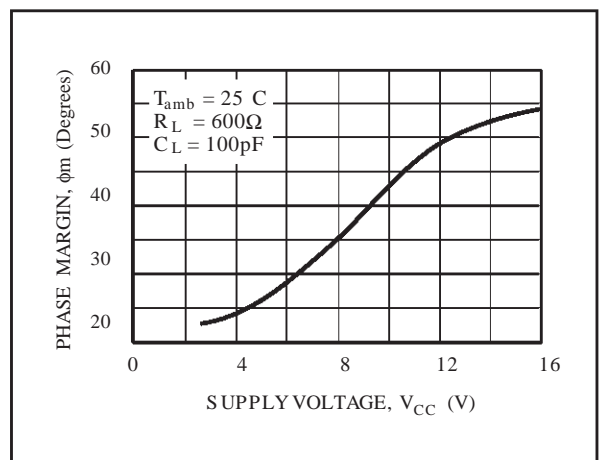
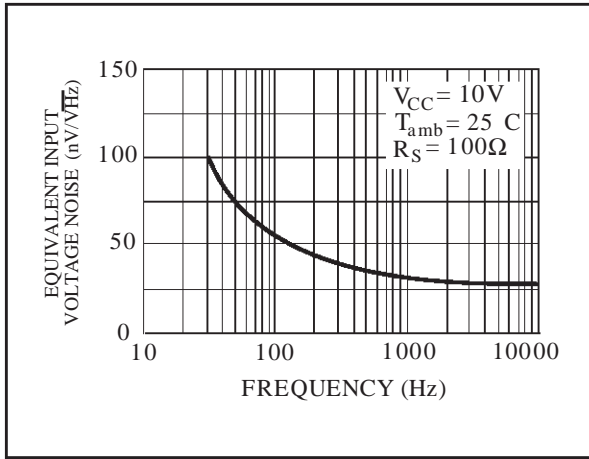

Figure 8 : Input Voltage Noise vs Frequency



MACROMODEL**Applies to : TS912 (V_{CC} = 3V)**

** Standard Linear Ics Macromodels, 1993.

** CONNECTIONS :

* 1 INVERTING INPUT

* 2 NON-INVERTING INPUT

* 3 OUTPUT

* 4 POSITIVE POWER SUPPLY

* 5 NEGATIVE POWER SUPPLY

.SUBCKT TS912_3 1 3 2 4 5 (analog)

.MODEL MDTH D IS=1E-8 KF=6.564344E-14 CJO=10F

* INPUT STAGE

CIP 2 5 1.000000E-12

CIN 1 5 1.000000E-12

EIP 10 5 2 5 1

EIN 16 5 1 5 1

RIP 10 11 6.500000E+00

RIN 15 16 6.500000E+00

RIS 11 15 1.271505E+01

DIP 11 12 MDTH 400E-12

DIN 15 14 MDTH 400E-12

VOFP 12 13 DC 0.000000E+00

VOFN 13 14 DC 0

IPOL 13 5 4.000000E-05

CPS 11 15 2.125860E-08

DINN 17 13 MDTH 400E-12

VIN 17 5 0.000000E+00

DINR 15 18 MDTH 400E-12

VIP 4 18 0.000000E+00

FCP 4 5 VOFP 5.000000E+00

FCN 5 4 VOFN 5.000000E+00

* AMPLIFYING STAGE

FIP 5 19 VOFP 2.750000E+02

FIN 5 19 VOFN 2.750000E+02

RG1 19 5 1.916825E+05

RG2 19 4 1.916825E+05

CC 19 29 2.200000E-08

HZTP 30 29 VOFP 1.3E+03

HZTN 5 30 VOFN 1.3E+03

DOPM 19 22 MDTH 400E-12

DONM 21 19 MDTH 400E-12

HOPM 22 28 VOUT 3800

VIPM 28 4 150

HONM 21 27 VOUT 3800

VINM 5 27 150

EOUT 26 23 19 5 1

VOUT 23 5 0

ROUT 26 3 75

COUT 3 5 1.000000E-12

DOP 19 68 MDTH 400E-12

VOP 4 25 1.724

HSCP 68 25 VSCP1 0.8E8

DON 69 19 MDTH 400E-12

VON 24 5 1.7419107

HSCN 24 69 VSCN1 0.8E+08

VSCTHP 60 61 0.0875

** VSCTHP = le seuil au dessus de vio * 500

** c.a.d 275U-000U dus a l'offset

DSCP1 61 63 MDTH 400E-12

VSCP1 63 64 0

ISCP 64 0 1.000000E-8

DSCP2 0 64 MDTH 400E-12

DSCN2 0 74 MDTH 400E-12

ISCN 74 0 1.000000E-8

VSCN1 73 74 0

DSCN1 71 73 MDTH 400E-12

VSCTHN 71 70 -0.55

** VSCTHN = le seuil au dessous de vio * 2000

** c.a.d -375U-000U dus a l'offset

ESCP 60 0 2 1 500

ESCN 70 0 2 1 -2000

.ENDS

ELECTRICAL CHARACTERISTICSV_{CC}⁺ = 3V, V_{CC}⁻ = 0V, R_L, C_L connected to V_{CC/2}, T_{amb} = 25°C (unless otherwise specified)

| Symbol | Conditions | Value | Unit |
|---------------------|---|-------------|------|
| V _{io} | | 0 | mV |
| A _{vd} | R _L = 10kΩ | 10 | V/mV |
| I _{CC} | No load, per operator | 200 | μA |
| V _{icm} | | -0.2 to 3.2 | V |
| V _{OH} | R _L = 10kΩ | 2.96 | V |
| V _{OL} | R _L = 10kΩ | 30 | mV |
| I _{sink} | V _O = 3V | 40 | mA |
| I _{source} | V _O = 0V | 40 | mA |
| GBP | R _L = 10kΩ, C _L = 100pF | 0.8 | MHz |
| SR | R _L = 10kΩ, C _L = 100pF | 0.3 | V/μs |

TS912

MACROMODEL

Applies to : TS912 ($V_{CC} = 5V$)

** Standard Linear Ics Macromodels, 1993.

** CONNECTIONS :

* 1 INVERTING INPUT

* 2 NON-INVERTING INPUT

* 3 OUTPUT

* 4 POSITIVE POWER SUPPLY

* 5 NEGATIVE POWER SUPPLY

* 6 STANDBY

.SUBCKT TS912_5 1 3 2 4 5 (analog)

.MODEL MDTH D IS=1E-8 KF=6.564344E-14 CJO=10F

* INPUT STAGE

CIP 2 5 1.000000E-12

CIN 1 5 1.000000E-12

EIP 10 5 2 5 1

EIN 16 5 1 5 1

RIP 10 11 6.500000E+00

RIN 15 16 6.500000E+00

RIS 11 15 7.322092E+00

DIP 11 12 MDTH 400E-12

DIN 15 14 MDTH 400E-12

VOFP 12 13 DC 0.000000E+00

VOFN 13 14 DC 0

IPOL 13 5 4.000000E-05

CPS 11 15 2.498970E-08

DINN 17 13 MDTH 400E-12

VIN 17 5 0.000000E+00

DINR 15 18 MDTH 400E-12

VIP 4 18 0.000000E+00

FCP 4 5 VOFP 5.750000E+00

FCN 5 4 VOFN 5.750000E+00

ISTB0 5 4 500N

* AMPLIFYING STAGE

FIP 5 19 VOFP 4.400000E+02

FIN 5 19 VOFN 4.400000E+02

RG1 19 5 4.904961E+05

RG2 19 4 4.904961E+05

CC 19 29 2.200000E-08

HZTP 30 29 VOFP 1.8E+03

HZTN 5 30 VOFN 1.8E+03

DOPM 19 22 MDTH 400E-12

DONM 21 19 MDTH 400E-12

HOPM 22 28 VOUT 3800

VIPM 28 4 230

HONM 21 27 VOUT 3800

VINM 5 27 230

EOUT 26 23 19 5 1

VOUT 23 5 0

ROUT 26 3 82

COU 3 5 1.000000E-12

DOP 19 68 MDTH 400E-12

VOP 4 25 1.724

HSCP 68 25 VSCP1 0.8E+08

DON 69 19 MDTH 400E-12

VON 24 5 1.7419107

HSCN 24 69 VSCN1 0.8E+08

VSCTHP 60 61 0.0875

** VSCTHP = le seuil au dessus de vio * 500

** c.a.d 275U-000U dus a l'offset

DSCP1 61 63 MDTH 400E-12

VSCP1 63 64 0

ISCP 64 0 1.000000E-8

DSCP2 0 64 MDTH 400E-12

DSCN2 0 74 MDTH 400E-12

ISCN 74 0 1.000000E-8

VSCN1 73 74 0

DSCN1 71 73 MDTH 400E-12

VSCTHN 71 70 -0.55

** VSCTHN = le seuil au dessous de vio * 2000

** c.a.d -375U-000U dus a l'offset

ESCP 60 0 2 1 500

ESCN 70 0 2 1 -2000

.ENDS

ELECTRICAL CHARACTERISTICS

$V_{CC+} = 5V$, $V_{CC-} = 0V$, R_L , C_L connected to $V_{CC}/2$, $T_{amb} = 25^\circ C$ (unless otherwise specified)

| Symbol | Conditions | Value | Unit |
|--------------|-----------------------------------|-------------|------------|
| V_{io} | | 0 | mV |
| A_{vd} | $R_L = 10k\Omega$ | 50 | V/mV |
| I_{CC} | No load, per operator | 230 | μA |
| V_{icm} | | -0.2 to 5.2 | V |
| V_{OH} | $R_L = 10k\Omega$ | 4.95 | V |
| V_{OL} | $R_L = 10k\Omega$ | 40 | mV |
| I_{sink} | $V_O = 5V$ | 65 | mA |
| I_{source} | $V_O = 0V$ | 65 | mA |
| GBP | $R_L = 10k\Omega$, $C_L = 100pF$ | 1 | MHz |
| SR | $R_L = 10k\Omega$, $C_L = 100pF$ | 0.8 | V/ μs |

PACKAGE MECHANICAL DATA
8 PINS - PLASTIC DIP

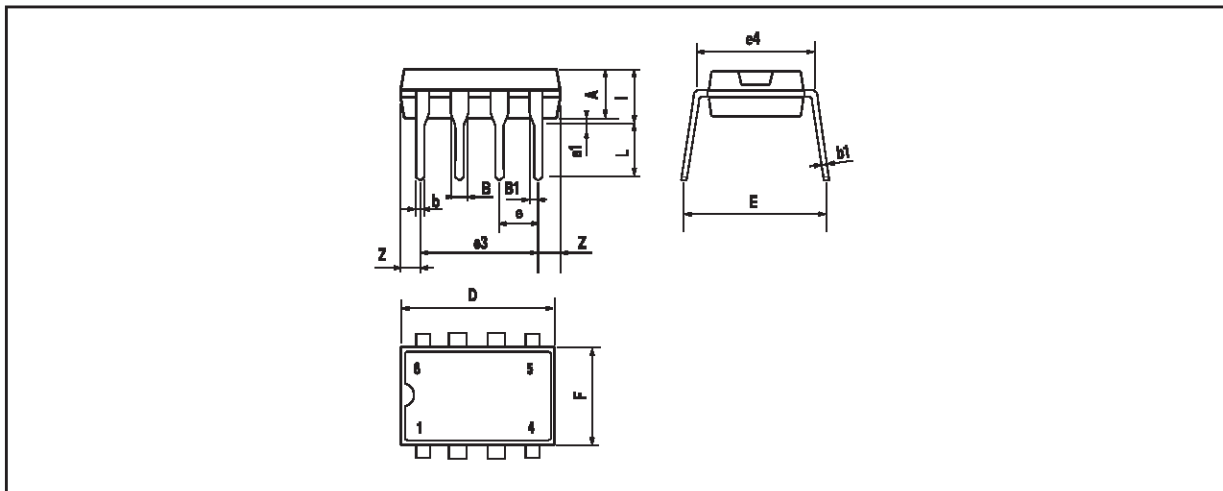

| Dim. | Millimeters | | | Inches | | |
|------|-------------|------|-------|--------|-------|-------|
| | Min. | Typ. | Max. | Min. | Typ. | Max. |
| A | | 3.32 | | | 0.131 | |
| a1 | 0.51 | | | 0.020 | | |
| B | 1.15 | | 1.65 | 0.045 | | 0.065 |
| b | 0.356 | | 0.55 | 0.014 | | 0.022 |
| b1 | 0.204 | | 0.304 | 0.008 | | 0.012 |
| D | | | 10.92 | | | 0.430 |
| E | 7.95 | | 9.75 | 0.313 | | 0.384 |
| e | | 2.54 | | | 0.100 | |
| e3 | | 7.62 | | | 0.300 | |
| e4 | | 7.62 | | | 0.300 | |
| F | | | 6.6 | | | 0.260 |
| i | | | 5.08 | | | 0.200 |
| L | 3.18 | | 3.81 | 0.125 | | 0.150 |
| Z | | | 1.52 | | | 0.060 |

PACKAGE MECHANICAL DATA
8 PINS - PLASTIC MICROPACKAGE (SO)

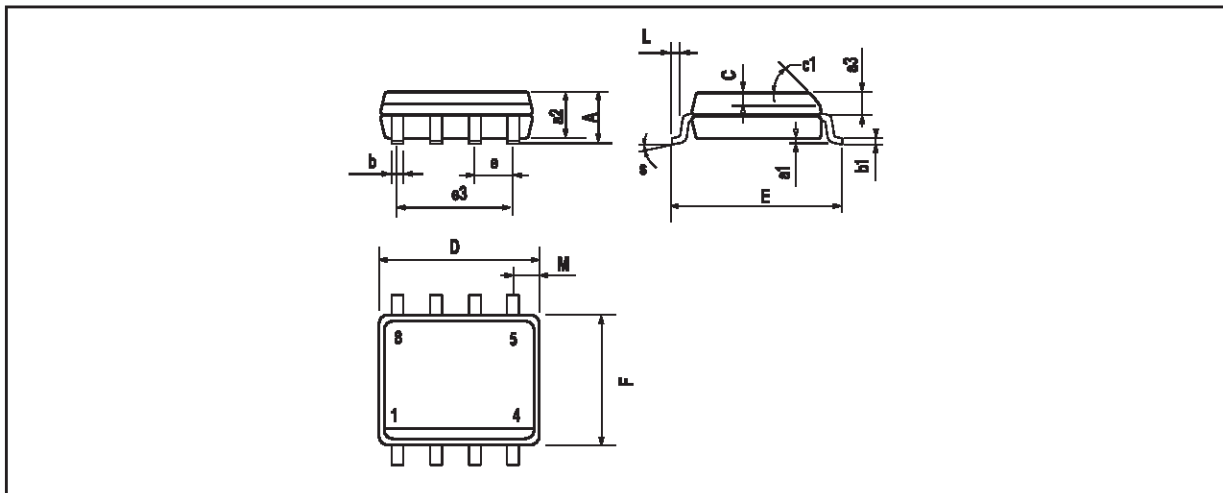

| Dim. | Millimeters | | | Inches | | |
|------|-------------|------|------|--------|-------|-------|
| | Min. | Typ. | Max. | Min. | Typ. | Max. |
| A | | | 1.75 | | | 0.069 |
| a1 | 0.1 | | 0.25 | 0.004 | | 0.010 |
| a2 | | | 1.65 | | | 0.065 |
| a3 | 0.65 | | 0.85 | 0.026 | | 0.033 |
| b | 0.35 | | 0.48 | 0.014 | | 0.019 |
| b1 | 0.19 | | 0.25 | 0.007 | | 0.010 |
| C | 0.25 | | 0.5 | 0.010 | | 0.020 |
| c1 | 45° (typ.) | | | | | |
| D | 4.8 | | 5.0 | 0.189 | | 0.197 |
| E | 5.8 | | 6.2 | 0.228 | | 0.244 |
| e | | 1.27 | | | 0.050 | |
| e3 | | 3.81 | | | 0.150 | |
| F | 3.8 | | 4.0 | 0.150 | | 0.157 |
| L | 0.4 | | 1.27 | 0.016 | | 0.050 |
| M | | | 0.6 | | | 0.024 |
| S | 8° (max.) | | | | | |

Information furnished is believed to be accurate and reliable. However, STMicroelectronics assumes no responsibility for the consequences of use of such information nor for any infringement of patents or other rights of third parties which may result from its use. No license is granted by implication or otherwise under any patent or patent rights of STMicroelectronics. Specifications mentioned in this publication are subject to change without notice. This publication supersedes and replaces all information previously supplied. STMicroelectronics products are not authorized for use as critical components in life support devices or systems without express written approval of STMicroelectronics.

© The ST logo is a registered trademark of STMicroelectronics

© 2001 STMicroelectronics - Printed in Italy - All Rights Reserved
STMicroelectronics GROUP OF COMPANIES

Australia - Brazil - Canada - China - Finland - France - Germany - Hong Kong - India - Israel - Italy - Japan - Malaysia
Malta - Morocco - Singapore - Spain - Sweden - Switzerland - United Kingdom - United States

© <http://www.st.com>