

INTRODUCTION

A growing number of sensitive electronic units can be found in motor vehicles. Unfortunately the presence of electrical disturbances threatens their reliability.

The objective of this paper is to list all these disruptive factors and to suggest appropriate protection devices.

Figure 1. Electronic modules in a car

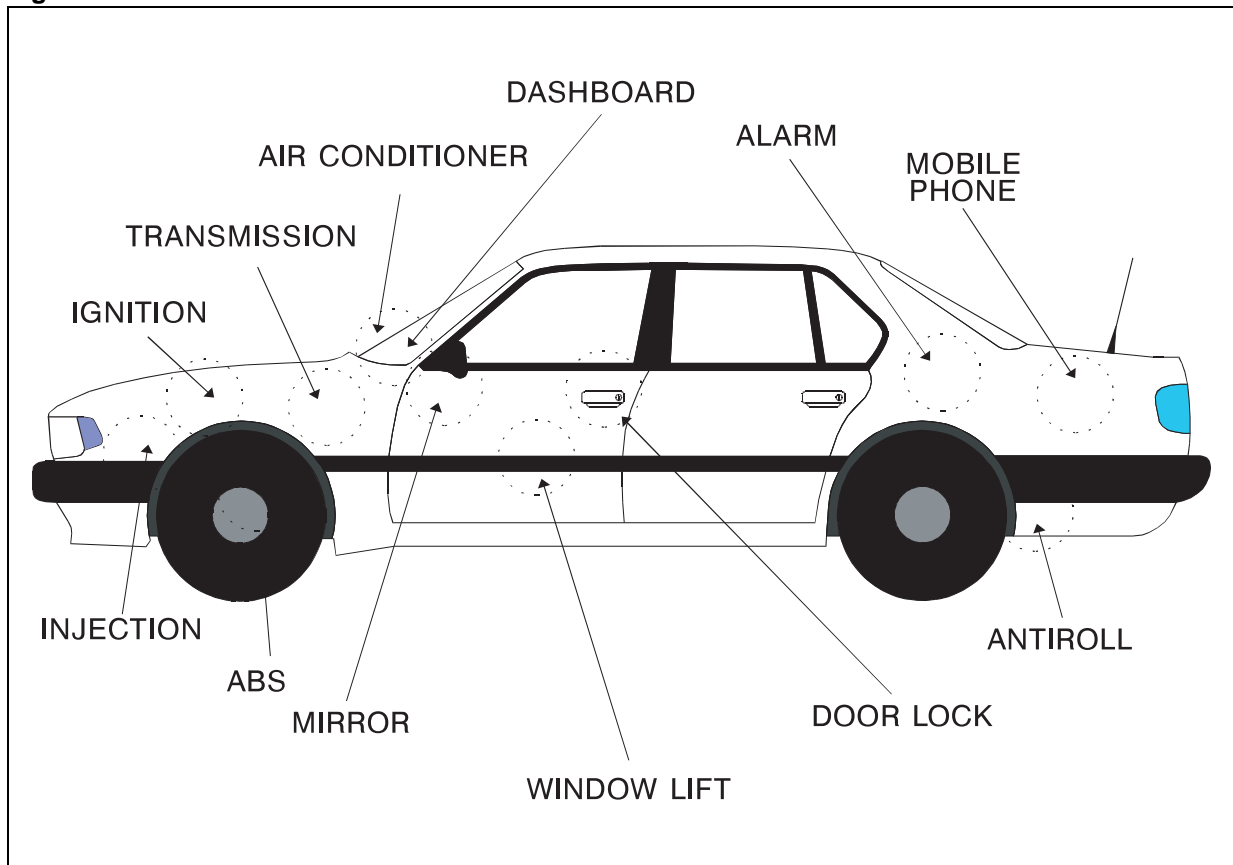

GENERAL INFORMATION

Simplified diagram of an automotive electrical circuit

Coexistence of electromechanical engineering with electronics

Figure 2 shows that the electrical system of a motor vehicle contains some electromechanical engineering which generates disturbances (alternator, ignition system, starter, relays, etc...) and some electronic equipment affected by these disturbances (instrument computer, injection unit, etc...). The role of the protection devices will be to ensure the smooth coexistence of both.

Figure 2. Automotive electrical diagram

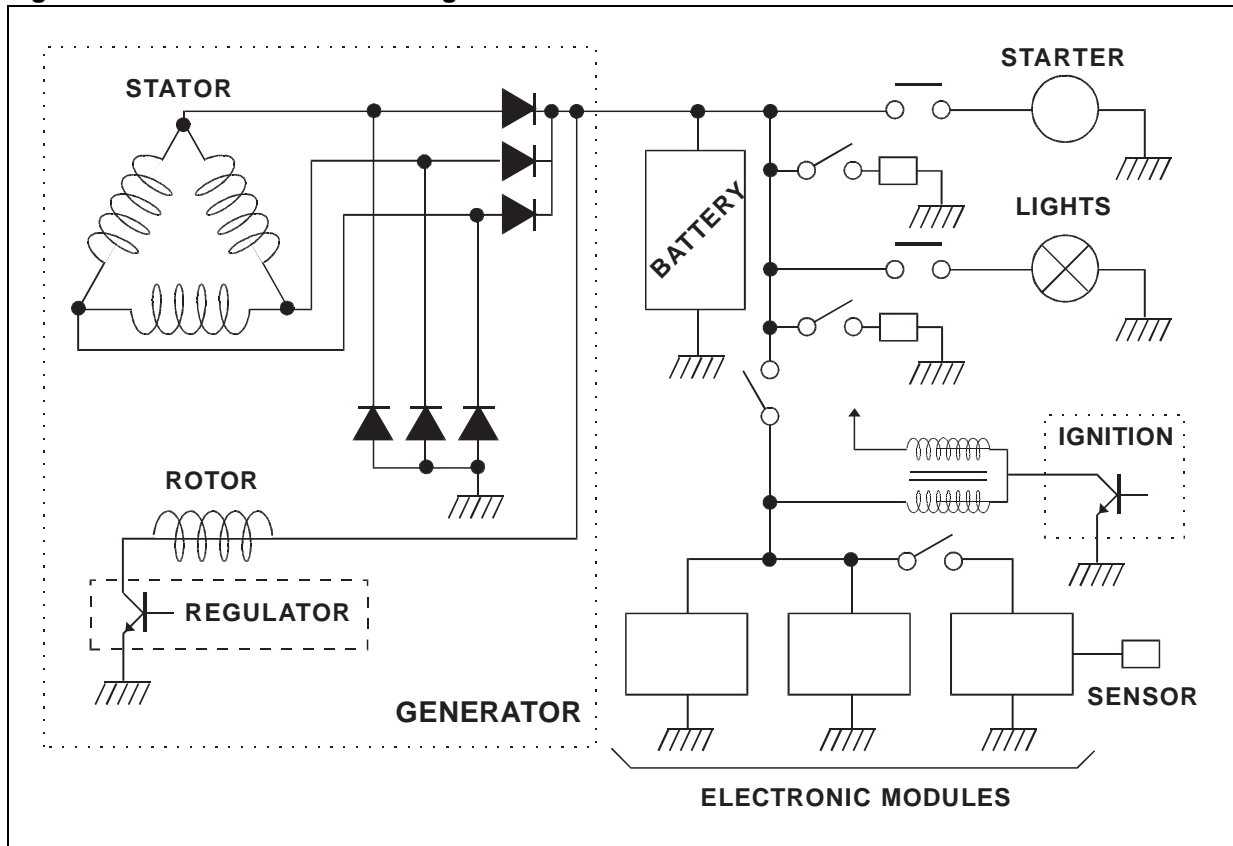

ORIGIN AND WAVEFORM PARAMETERS

Electronic units receive the disturbances through the various cables which are connected to them. They are defined by the ISO/TC 22 standards and described in appropriate technical notes issued by the various motor vehicle manufacturers.

Disconnecting inductive loads

Disconnecting an inductive element causes a high inverted overvoltage on its terminals.

Figure 3. Shape of test pulse 1 (disconnection of Inductive Loads)

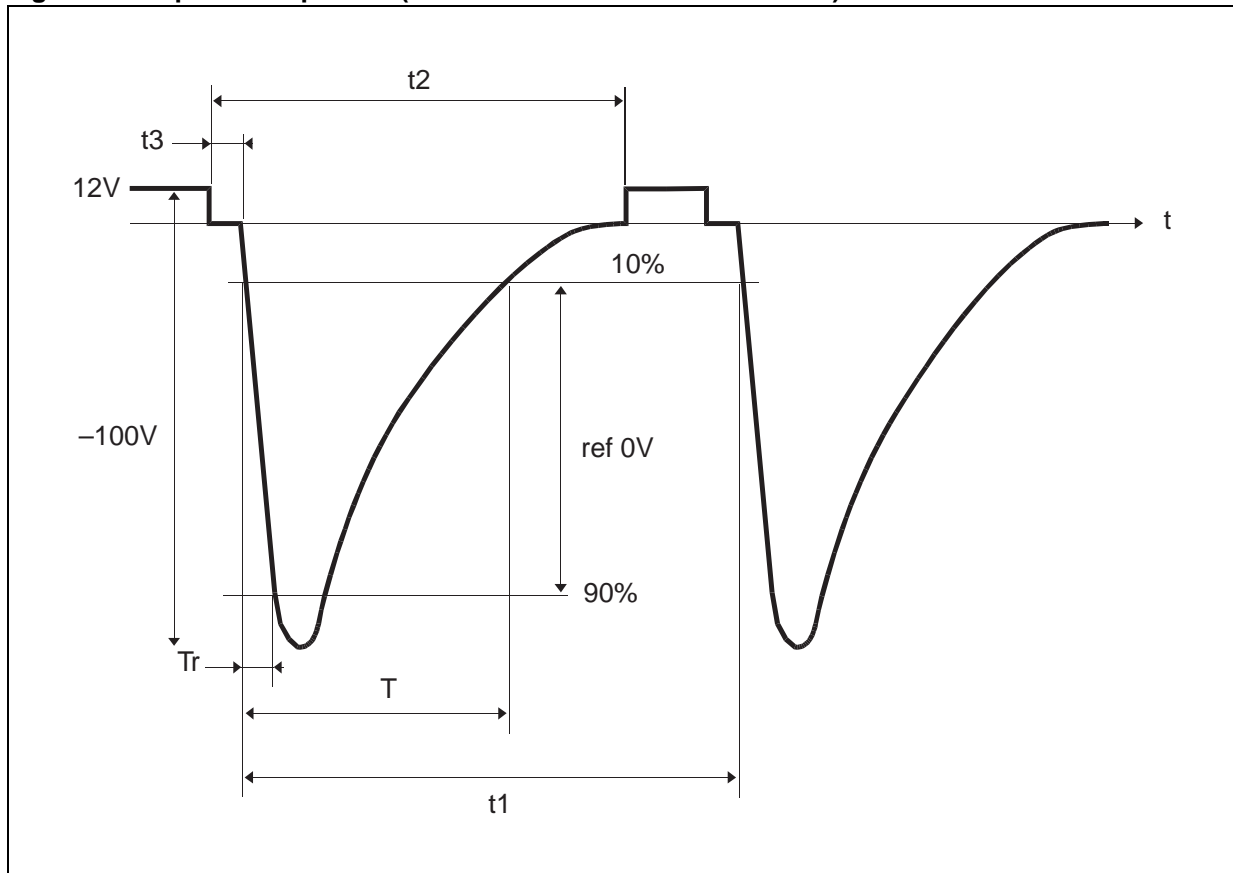

Note: T = 2 milliseconds
 Tr = 1 microsecond
 Ri = 10 ohms (Internal series resistor of the surge generator)
 t1 = 5 seconds
 t2 = 0.2 second
 t3 < 100 ms

Sudden power cut off in the main circuit

After the battery supply circuit is cut by the ignition key, the ignition circuit continues to release disturbances until the engine stops rotating.

Overvoltages are generated by switching the power supplied by electric motors acting as generators, e.g. the air conditioning fan. Their amplitude is increased by the absence of the filtering which would normally be carried out by the battery.

Figure 4. Shape of test pulse 2 (Sudden Interruption of Series Current)

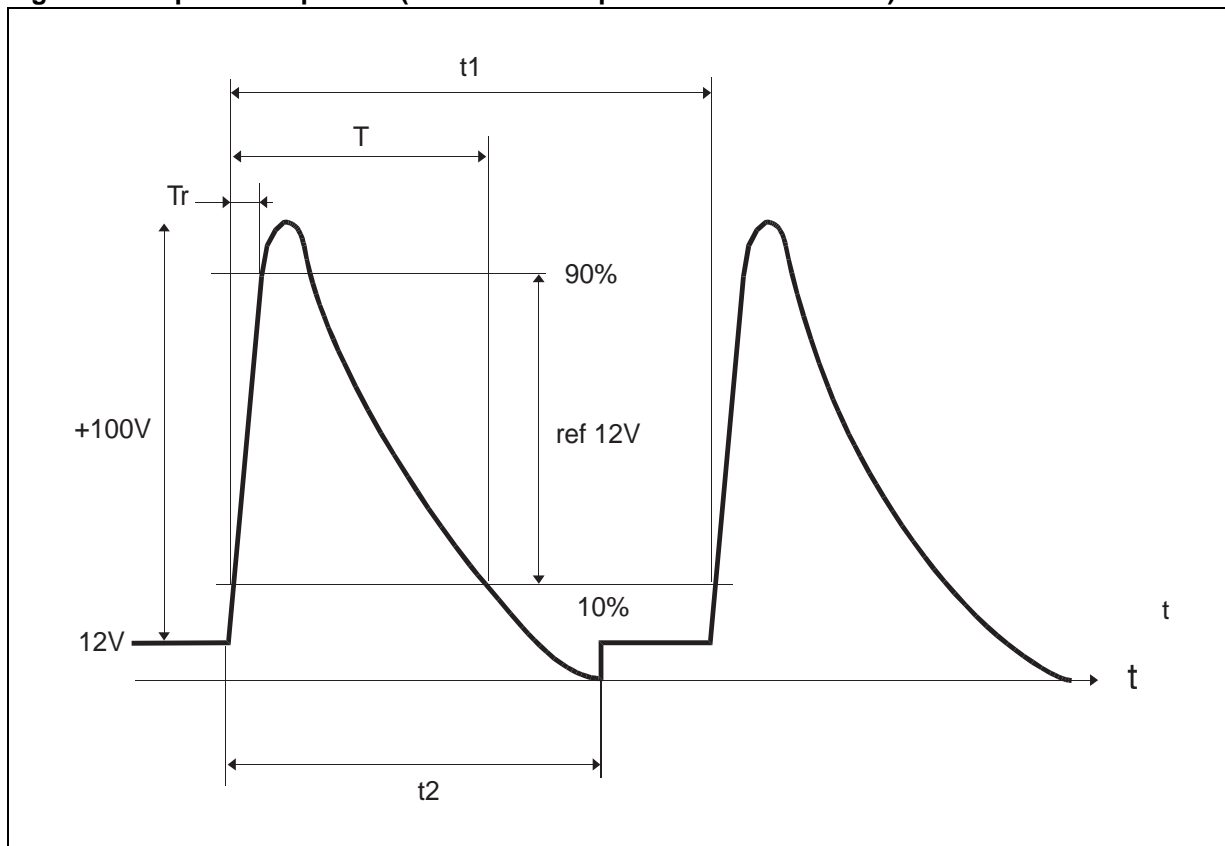

Note: T = 2 milliseconds
Tr = 1 microsecond
Ri = 10 ohms
t1 = 0.5 to 5 seconds
t2 = 0.2 second

Switch bounce

Power cut-off in the supply network capacitances and inductances, resulting from switch rebounds, generates sets of disturbances.

Figure 5. Shape of test pulse 3A (switching spikes)

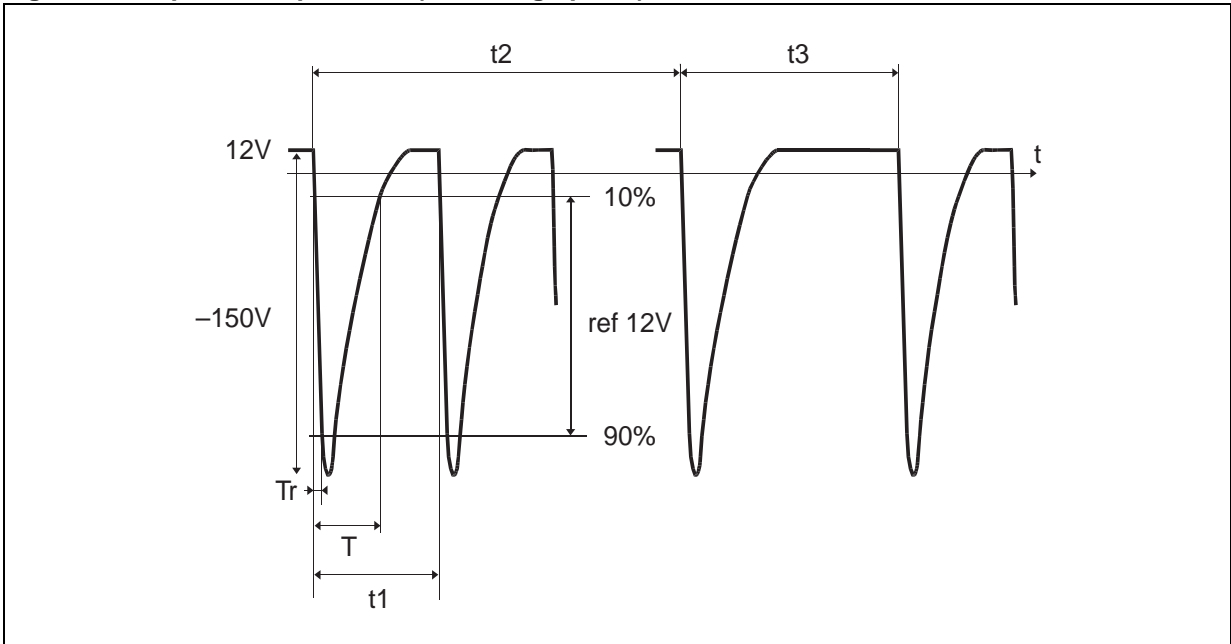

Note: T = 0.1 microsecond
 Tr = 5 nanoseconds
 Ri = 50 ohms
 t1 = 100 microseconds
 t2 = 10 milliseconds
 t3 = 90 milliseconds

Figure 6. Shape of test pulse 3B (switching spikes)

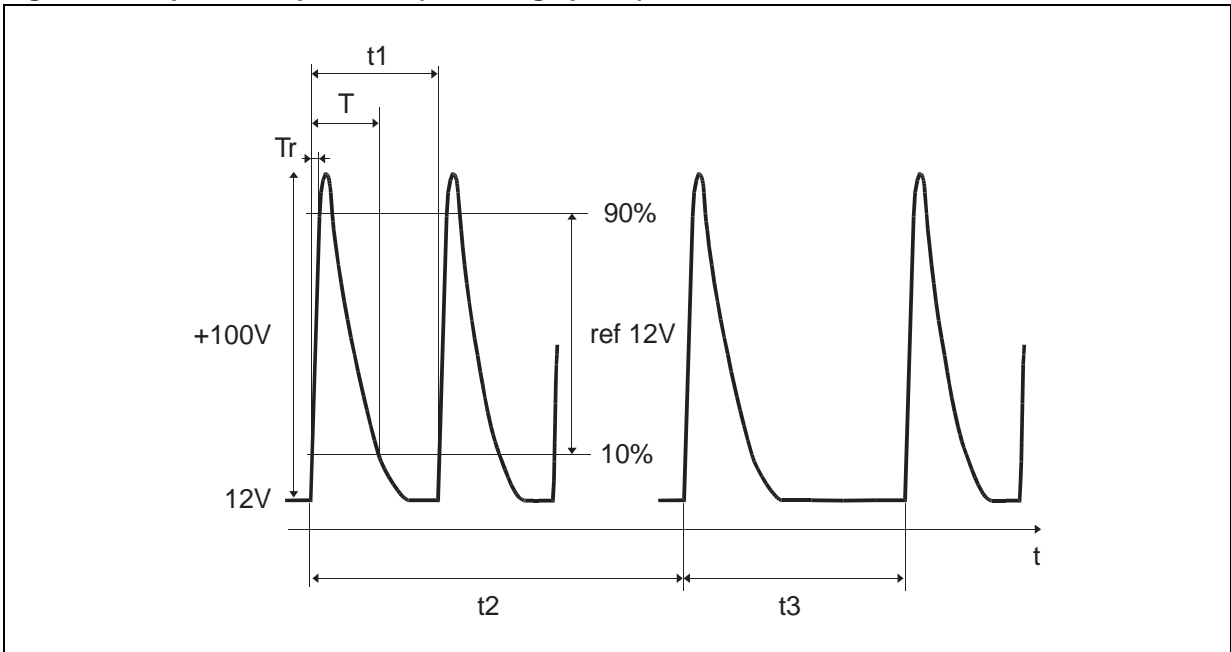

Note: T = 0.1 microsecond
 Tr = 5 nanoseconds
 Ri = 50 ohms
 t1 = 100 microseconds
 t2 = 10 milliseconds
 t3 = 90 milliseconds

AN553 APPLICATION NOTE

Activating the starter

When the starter circuit is activated, a voltage drop occurs in the supply source.

Figure 7. Shape of test pulse 4 (starter motor engagement disturbance)

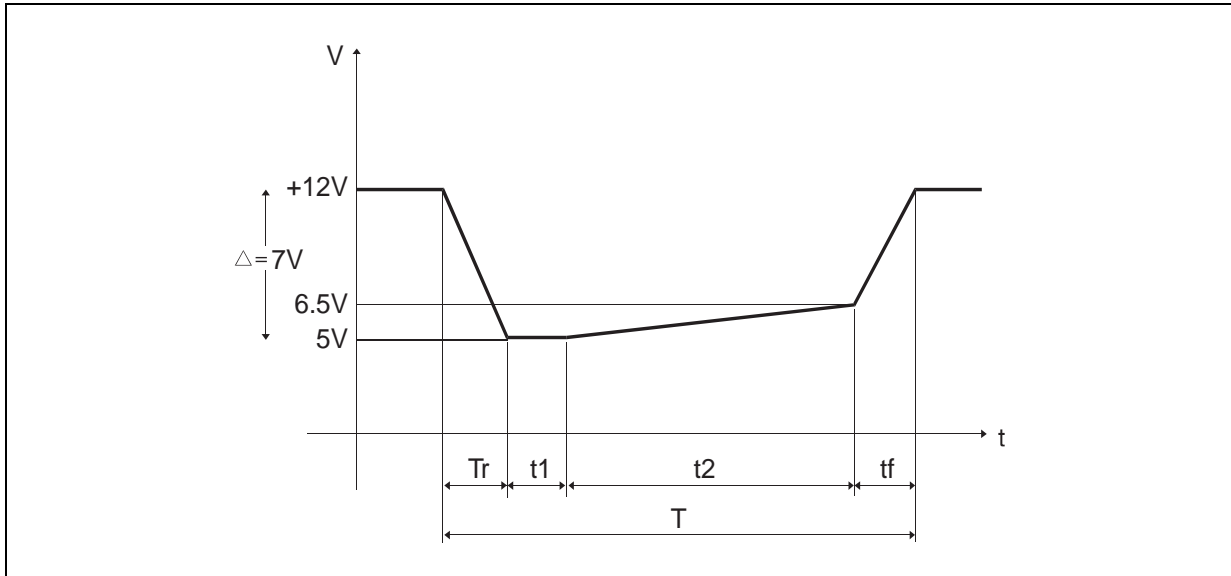

Note: T = 130 milliseconds
Ri = 0.01 ohm
Tr = 10 milliseconds
t1 = 10 milliseconds
t2 = 100 milliseconds
Tf = 10 milliseconds

Load dump

This happens when the battery is disconnected whilst being charged by the alternator.

During this load dump, the voltage on the alternator terminals increases rapidly. The length of this disturbance depends on the time constant of the generator excitation circuit.

Figure 8. Shape of test pulse 5 (load dump)

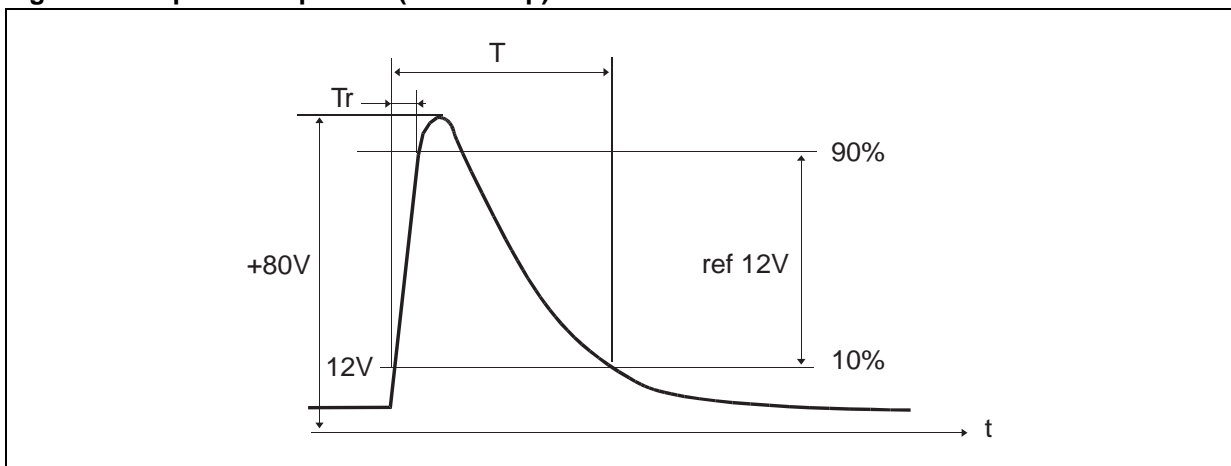

Note: Tr < 10 milliseconds
Ri = 2 ohms
T = 300 ms

Power cut off in the ignition coil

This disturbance occurs when the ignition contact is cut off.

Figure 9. Shape of test pulse 6 (ignition coil current interruption)

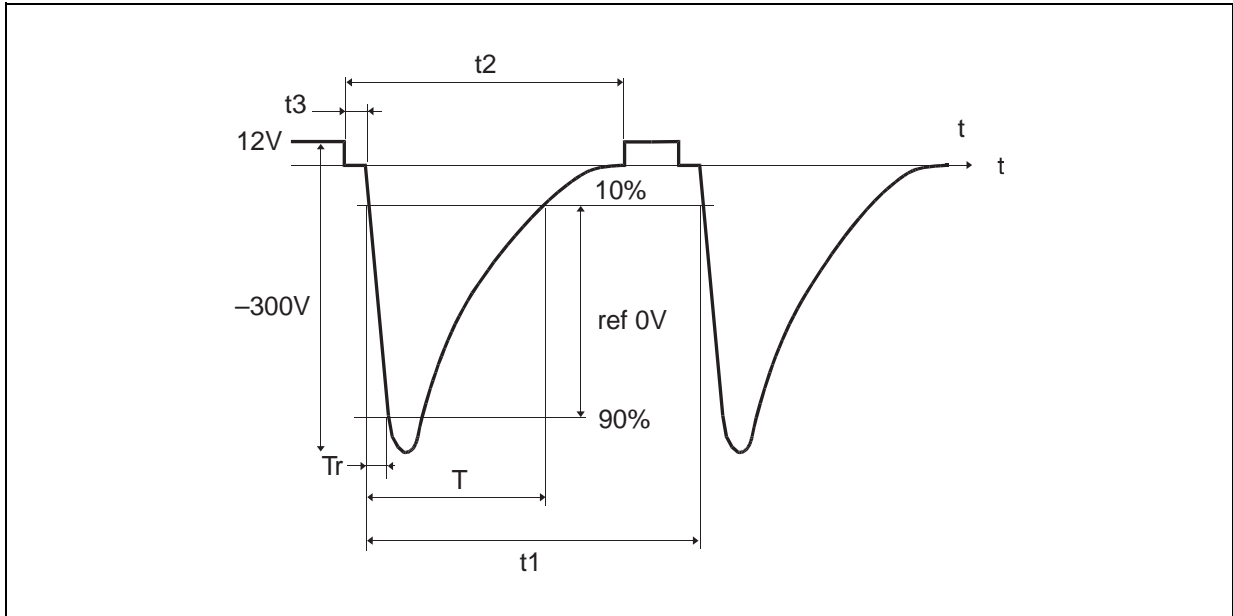

Note: T = 300 microseconds
 Tr = 60 microseconds
 Ri = 30 ohms
 t1 = 15 seconds
 t2 = 1 second
 t3 < 100 microseconds

Alternator magnetic field decay

This negative overvoltage appears when the magnetic field of the alternator disappears (when the engine stops turning).

Figure 10. Shape of test pulse 7 (alternator field transient at engine stop)

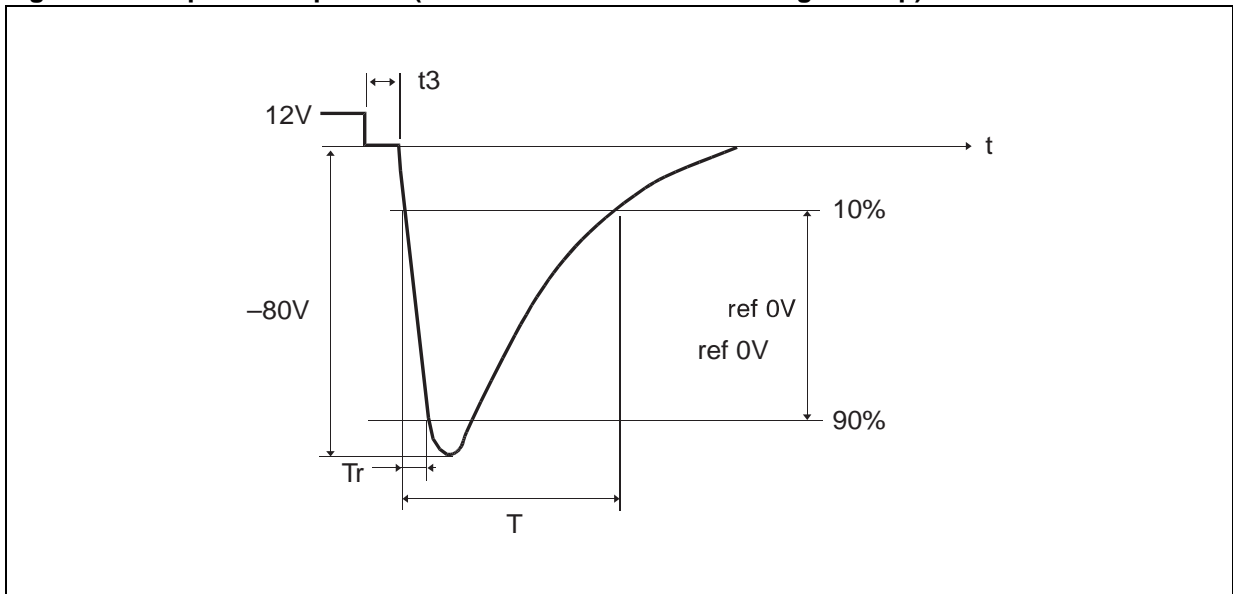

Note: T = 100 milliseconds
Tr = 5 to 10 milliseconds
Ri = 10 ohms
t3 < 100 microseconds

Regulator failure

This type of problem can cause the output generated to be permanently too high, perhaps greater than 18V.

Starting aid

In certain cases, when new motor vehicles have been stored over a long period (eg. sea deliveries, when starting takes place at low temperatures, etc...) using another source of energy other than that of the vehicle becomes necessary.

The most common procedure is the use of two standard 12 Volt batteries paralleled with that of the vehicle. The overvoltage estimate is 24 Volts (or -24V in the case of an inverted connection).

Miscellaneous

Motor vehicles can be subject to other sources of disturbances, such as:

- the connection to a diagnostic unit.
- electric soldering.
- paint electrostatic tension.
- HF rays generated by transmission equipment.

ANALYSIS OF THE VARIOUS DISTURBANCES

Table 1. Analysis of the Various Disturbances

Origin	Duration	Voltage	Energy	Frequency
Disconnection of inductive loads	2ms	-100V	2.3j	Frequent
Power cut-off in the main circuit	2ms	+100V	2.3j	Frequent
Switch bounce	0.1s x 10	+100V / -150V	50j x 10	Frequent
Starter engagement	130ms	-	-	At every start
Load dump	300ms	+80V	50j	Rare
Ignition	300s	-300V	0.003j	Frequent
Alternator magnetic field decay	100 ms	-80V	0.2j	At every stop
Imperfections at regulator level	Continuous	+18V	-	Rare
Starting aid	Several minutes	24V	-	Rare

CONCLUSION

Table 1 shows that we are confronted with 5 types of disturbances

- a. Positive impulsive overvoltages
- b. Negative impulsive overvoltages
- c. Positive continuous overvoltages
- d. Negative continuous overvoltages
- e. Impulsive voltage drop

The goal of protection circuits is to prevent destruction due to these disturbances.

AN553 APPLICATION NOTE

REVISION HISTORY

Table 2. Revision History

Date	Revision	Description of Changes
December-1992	1	First Issue
18-May-2004	2	Stylesheet update. No content change.

Information furnished is believed to be accurate and reliable. However, STMicroelectronics assumes no responsibility for the consequences of use of such information nor for any infringement of patents or other rights of third parties which may result from its use. No license is granted by implication or otherwise under any patent or patent rights of STMicroelectronics. Specifications mentioned in this publication are subject to change without notice. This publication supersedes and replaces all information previously supplied. STMicroelectronics products are not authorized for use as critical components in life support devices or systems without express written approval of STMicroelectronics.

The ST logo is a registered trademark of STMicroelectronics.
All other names are the property of their respective owners

© 2004 STMicroelectronics - All rights reserved

STMicroelectronics GROUP OF COMPANIES

Australia - Belgium - Brazil - Canada - China - Czech Republic - Finland - France - Germany - Hong Kong - India - Israel - Italy - Japan -
Malaysia - Malta - Morocco - Singapore - Spain - Sweden - Switzerland - United Kingdom - United States

www.st.com