

LMC6001 Ultra Ultra-Low Input Current Amplifier

Check for Samples: [LMC6001](#)

FEATURES

- (Max Limit, 25°C Unless Otherwise Noted)
- Input Current (100% Tested): 25 fA
- Input Current Over Temp.: 2 pA
- Low Power: 750 μ A
- Low V_{OS} : 350 μ V
- Low Noise: 22 nV/\sqrt{Hz} @1 kHz Typ.

APPLICATIONS

- Electrometer Amplifier
- Photodiode Preamplifier
- Ion Detector
- A.T.E. Leakage Testing

DESCRIPTION

Featuring 100% tested input currents of 25 fA max., low operating power, and ESD protection of 2000V, the LMC6001 achieves a new industry benchmark for low input current operational amplifiers. By tightly controlling the molding compound, Texas Instruments is able to offer this ultra-low input current in a lower cost molded package.

To avoid long turn-on settling times common in other low input current opamps, the LMC6001A is tested 3 times in the first minute of operation. Even units that meet the 25 fA limit are rejected if they drift.

Because of the ultra-low input current noise of 0.13 fA/\sqrt{Hz} , the LMC6001 can provide almost noiseless amplification of high resistance signal sources. Adding only 1 dB at 100 k Ω , 0.1 dB at 1 M Ω and 0.01 dB or less from 10 M Ω to 2,000 M Ω , the LMC6001 is an almost noiseless amplifier.

The LMC6001 is ideally suited for electrometer applications requiring ultra-low input leakage such as sensitive photodetection transimpedance amplifiers and sensor amplifiers. Since input referred noise is only 22 nV/\sqrt{Hz} , the LMC6001 can achieve higher signal to noise ratio than JFET input type electrometer amplifiers. Other applications of the LMC6001 include long interval integrators, ultra-high input impedance instrumentation amplifiers, and sensitive electrical-field measurement circuits.

Connection Diagrams

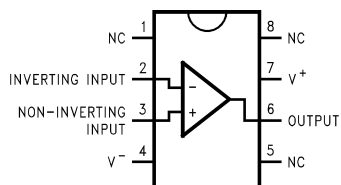

Figure 1. 8-Pin PDIP (Top View)
See P Package

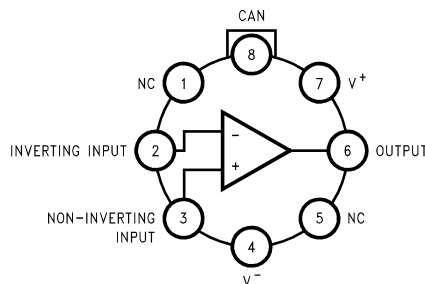

Figure 2. 8-Pin TO-99 (Top View)
See LMC Package



These devices have limited built-in ESD protection. The leads should be shorted together or the device placed in conductive foam during storage or handling to prevent electrostatic damage to the MOS gates.



Please be aware that an important notice concerning availability, standard warranty, and use in critical applications of Texas Instruments semiconductor products and disclaimers thereto appears at the end of this data sheet.

All trademarks are the property of their respective owners.

Absolute Maximum Ratings⁽¹⁾⁽²⁾

Differential Input Voltage	±Supply Voltage
Voltage at Input/Output Pin	(V ⁺) + 0.3V, (V ⁻) - 0.3V
Supply Voltage (V ⁺ - V ⁻)	-0.3V to +16V
Output Short Circuit to V ⁺	See ⁽³⁾⁽⁴⁾
Output Short Circuit to V ⁻	See ⁽³⁾
(Soldering, 10 Sec.) Lead Temperature	260°C
Storage Temperature	-65°C to +150°C
Junction Temperature	150°C
Current at Input Pin	±10 mA
Current at Output Pin	±30 mA
Current at Power Supply Pin	40 mA
Power Dissipation	See ⁽⁵⁾
ESD Tolerance ⁽⁵⁾	2 kV

- (1) Absolute Maximum Ratings indicate limits beyond which damage to the device may occur. Operating Ratings indicate conditions for which the device is intended to be functional but do not ensure specific performance limits. For ensured specifications and test conditions, see the Electrical Characteristics. The ensured specifications apply only for the test conditions listed.
- (2) If Military/Aerospace specified devices are required, please contact the Texas Instruments Sales Office/ Distributors for availability and specifications.
- (3) Applies to both single supply and split supply operation. Continuous short circuit operation at elevated ambient temperature can result in exceeding the maximum allowed junction temperature of 150°C. Output currents in excess of ±30 mA over long term may adversely affect reliability.
- (4) Do not connect the output to V⁺, when V⁺ is greater than 13V or reliability will be adversely affected.
- (5) Human body model, 1.5 kΩ in series with 100 pF.

Operating Ratings⁽¹⁾

Temperature Range (LMC6001AI, LMC6001BI, LMC6001CI)	-40°C ≤ T _J ≤ +85°C	
Supply Voltage	4.5V ≤ V ⁺ ≤ 15.5V	
Thermal Resistance ⁽²⁾	θ _{JA} , P Package	100°C/W
	θ _{JA} , LMC Package	145°C/W
	θ _{JC} , LMC Package	45°C/W
Power Dissipation	See ⁽³⁾	

- (1) Absolute Maximum Ratings indicate limits beyond which damage to the device may occur. Operating Ratings indicate conditions for which the device is intended to be functional but do not ensure specific performance limits. For ensured specifications and test conditions, see the Electrical Characteristics. The ensured specifications apply only for the test conditions listed.
- (2) All numbers apply for packages soldered directly into a printed circuit board.
- (3) For operating at elevated temperatures the device must be derated based on the thermal resistance θ_{JA} with P_D = (T_J - T_A)/θ_{JA}.

DC Electrical Characteristics

Limits in standard typeface ensured for $T_J = 25^\circ\text{C}$ and limits in **boldface type** apply at the temperature extremes. Unless otherwise specified, $V^+ = 5\text{V}$, $V^- = 0\text{V}$, $V_{\text{CM}} = 1.5\text{V}$, and $R_L > 1\text{M}$.

Symbol	Parameter	Conditions	Typical ⁽¹⁾	Limits ⁽²⁾			Units
				LMC6001AI	LMC6001BI	LMC6001CI	
I_B	Input Current	Either Input, $V_{\text{CM}} = 0\text{V}$, $V_S = \pm 5\text{V}$	10	25 2000	100 4000	1000 4000	fA
I_{OS}	Input Offset Current		5	1000	2000	2000	
V_{OS}	Input Offset Voltage			0.35 1.0	1.0 1.7	1.0 2.0	mV
		$V_S = \pm 5\text{V}$, $V_{\text{CM}} = 0\text{V}$		0.7 1.35	1.35 2.0	1.35	
TCV_{OS}	Input Offset Voltage Drift		2.5	10	10		$\mu\text{V}/^\circ\text{C}$
R_{IN}	Input Resistance		>1				Tera Ω
CMRR	Common Mode Rejection Ratio	$0\text{V} \leq V_{\text{CM}} \leq 7.5\text{V}$	83	75 72	72 68	66 63	dB
		$V^+ = 10\text{V}$		70	63	63	
+PSRR	Positive Power Supply Rejection Ratio	$5\text{V} \leq V^+ \leq 15\text{V}$	83	73 70	66 63	66 63	dB min
-PSRR	Negative Power Supply Rejection Ratio	$0\text{V} \geq V^- \geq -10\text{V}$	94	80 77	74 71	74 71	
A_V	Large Signal Voltage Gain	Sourcing, $R_L = 2\text{k}\Omega$ ⁽³⁾	1400	400 300	300 200	300 200	V/mV min
		Sinking, $R_L = 2\text{k}\Omega$ ⁽³⁾	350	180 100	90 60	90 60	
V_{CM}	Input Common-Mode Voltage	$V^+ = 5\text{V}$ and 15V For CMRR $\geq 60\text{ dB}$	-0.4	-0.1 0	-0.1 0	-0.1 0	V max
			$V^+ - 1.9$	$V^+ - 2.3$ $V^+ - 2.5$	$V^+ - 2.3$ $V^+ - 2.5$	$V^+ - 2.3$ $V^+ - 2.5$	V min
V_O	Output Swing	$V^+ = 5\text{V}$ $R_L = 2\text{k}\Omega$ to 2.5V	4.87	4.80 4.73	4.75 4.67	4.75 4.67	V min
			0.10	0.14 0.17	0.20 0.24	0.20 0.24	V max
		$V^+ = 15\text{V}$ $R_L = 2\text{k}\Omega$ to 7.5V	14.63	14.50 14.34	14.37 14.25	14.37 14.25	V min
			0.26	0.35 0.45	0.44 0.56	0.44 0.56	V max
I_O	Output Current	Sourcing, $V^+ = 5\text{V}$, $V_O = 0\text{V}$	22	16 10	13 8	13 8	mA min
		Sinking, $V^+ = 5\text{V}$, $V_O = 5\text{V}$	21	16 13	13 10	13 10	
		Sourcing, $V^+ = 15\text{V}$, $V_O = 0\text{V}$	30	28 22	23 18	23 18	
		Sinking, $V^+ = 15\text{V}$, $V_O = 13\text{V}$ ⁽⁴⁾	34	28 22	23 18	23 18	

(1) Typical values represent the most likely parametric norm.

(2) All limits are specified by testing or statistical analysis.

(3) $V^+ = 15\text{V}$, $V_{\text{CM}} = 7.5\text{V}$ and R_L connected to 7.5V . For Sourcing tests, $7.5\text{V} \leq V_O \leq 11.5\text{V}$. For Sinking tests, $2.5\text{V} \leq V_O \leq 7.5\text{V}$.

(4) Do not connect the output to V^+ , when V^+ is greater than 13V or reliability will be adversely affected.

DC Electrical Characteristics (continued)

Limits in standard typeface ensured for $T_J = 25^\circ\text{C}$ and limits in **boldface type** apply at the temperature extremes. Unless otherwise specified, $V^+ = 5\text{V}$, $V^- = 0\text{V}$, $V_{\text{CM}} = 1.5\text{V}$, and $R_L > 1\text{M}$.

Symbol	Parameter	Conditions	Typical ⁽¹⁾	Limits ⁽²⁾			Units
				LMC6001AI	LMC6001BI	LMC6001CI	
I_S	Supply Current	$V^+ = 5\text{V}$, $V_O = 1.5\text{V}$	450	750 900	750 900	750 900	μA max
		$V^+ = 15\text{V}$, $V_O = 7.5\text{V}$	550	850 950	850 950	850 950	

AC Electrical Characteristics

Limits in standard typeface ensured for $T_J = 25^\circ\text{C}$ and limits in **boldface type** apply at the temperature extremes. Unless otherwise specified, $V^+ = 5\text{V}$, $V^- = 0\text{V}$, $V_{\text{CM}} = 1.5\text{V}$ and $R_L > 1\text{M}$.

Symbol	Parameter	Conditions	Typical ⁽¹⁾	Limits ⁽²⁾			Units
				LM6001AI	LM6001BI	LM6001CI	
SR	Slew Rate	See ⁽³⁾	1.5	0.8 0.6	0.8 0.6	0.8 0.6	$\text{V}/\mu\text{s}$ min
GBW	Gain-Bandwidth Product		1.3				MHz
ϕ_{m}	Phase Margin		50				Deg
G_M	Gain Margin		17				dB
e_n	Input-Referred Voltage Noise	$F = 1\text{ kHz}$	22				$\text{nV}/\sqrt{\text{Hz}}$
i_n	Input-Referred Current Noise	$F = 1\text{ kHz}$	0.13				$\text{fA}/\sqrt{\text{Hz}}$
THD	Total Harmonic Distortion	$F = 10\text{ kHz}$, $A_V = -10$, $R_L = 100\text{ k}\Omega$, $V_O = 8\text{ V}_{\text{PP}}$	0.01				%

(1) Typical values represent the most likely parametric norm.

(2) All limits are specified by testing or statistical analysis.

(3) $V^+ = 15\text{V}$. Connected as Voltage Follower with 10V step input. Limit specified is the lower of the positive and negative slew rates.

Typical Performance Characteristics

$V_S = \pm 7.5V$, $T_A = 25^\circ C$, unless otherwise specified

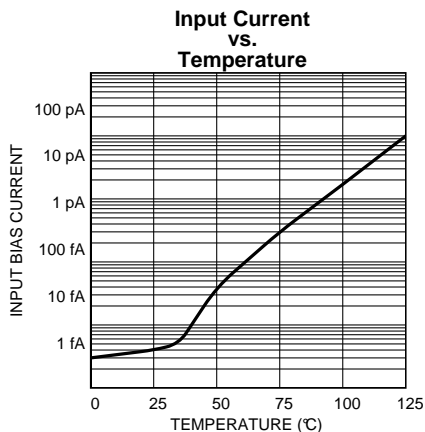

Figure 3.

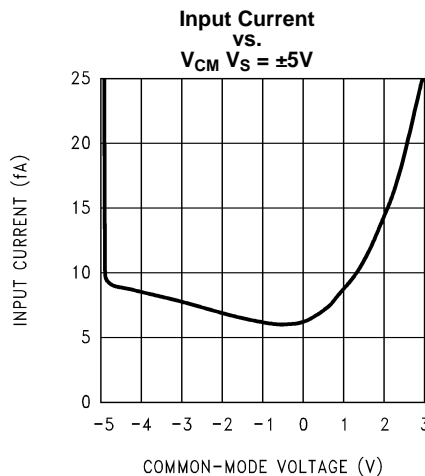

Figure 4.

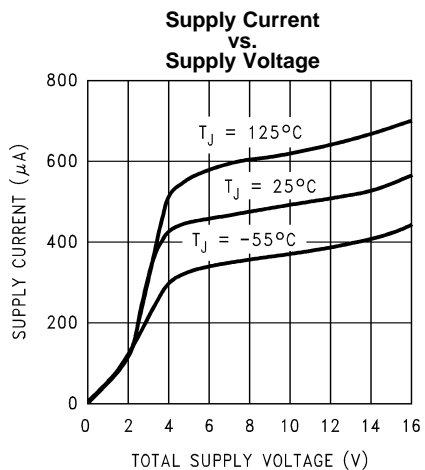

Figure 5.

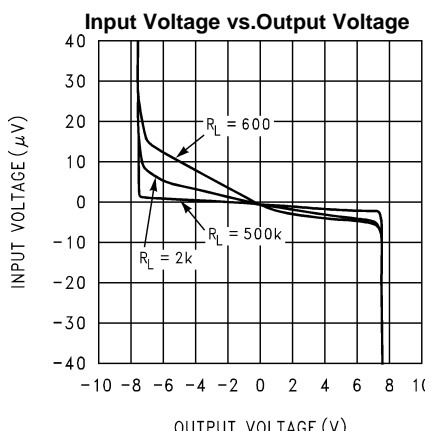

Figure 6.

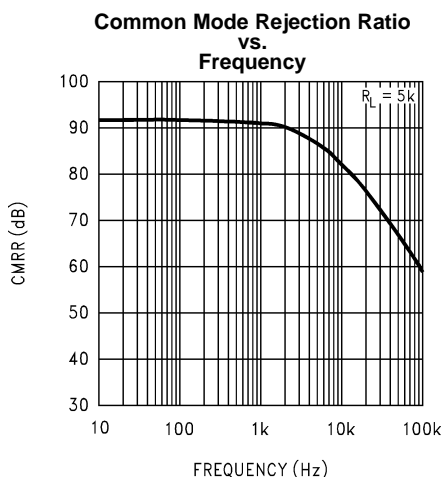

Figure 7.

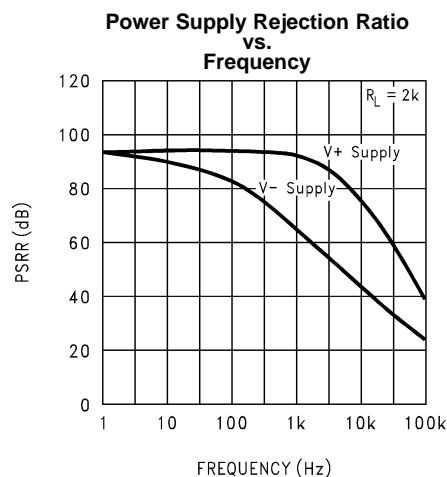

Figure 8.

Typical Performance Characteristics (continued)

$V_S = \pm 7.5V$, $T_A = 25^\circ C$, unless otherwise specified

Input Voltage Noise vs. Frequency

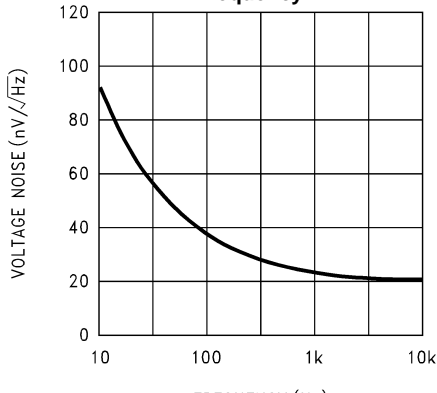

Figure 9.

Noise Figure vs. Source Resistance

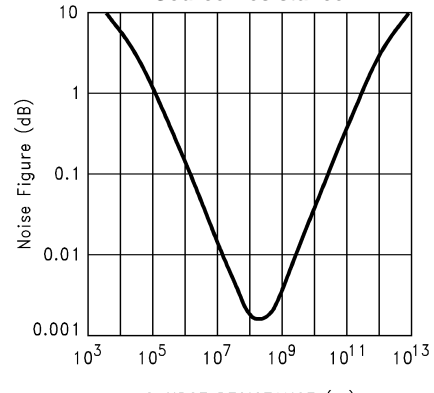

Figure 10.

Output Characteristics Sourcing Current

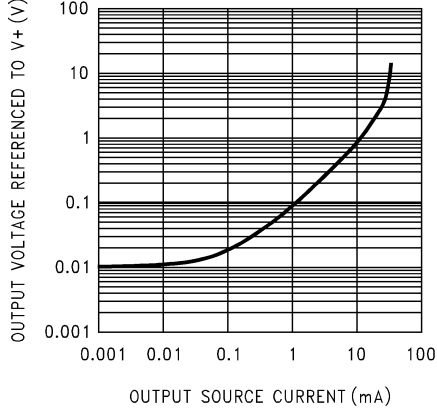

Figure 11.

Output Characteristics Sinking Current

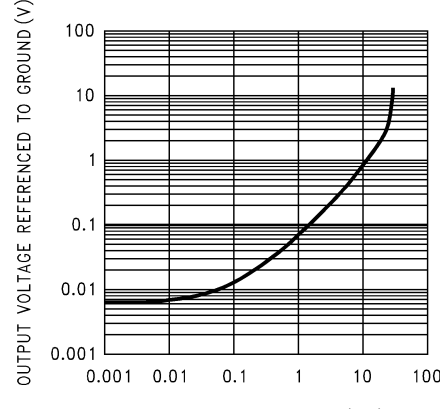

Figure 12.

Gain and Phase Response vs. Temperature (-55°C to +125°C)

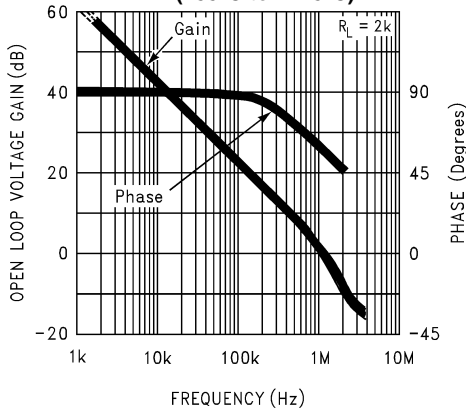

Figure 13.

Gain and Phase Response vs. Capacitive Load with $R_L = 500k\Omega$

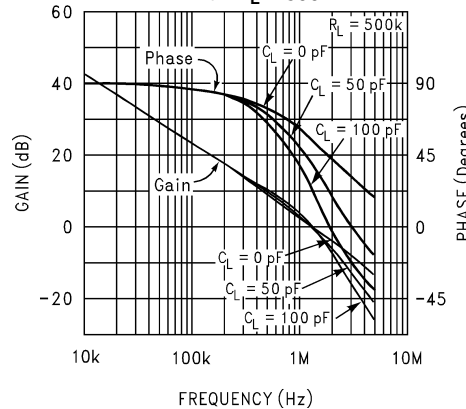
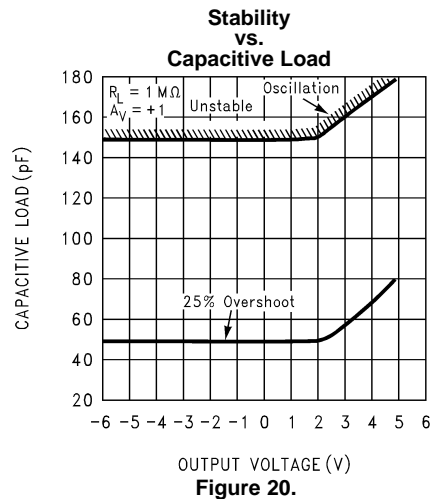
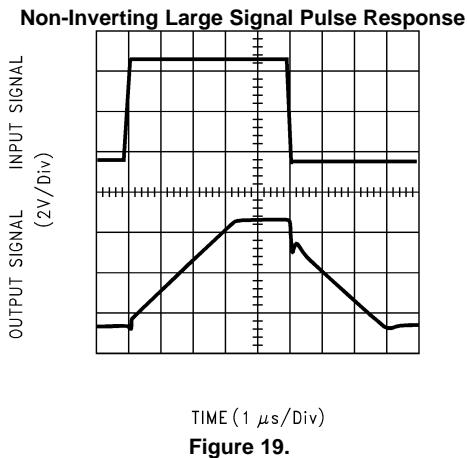
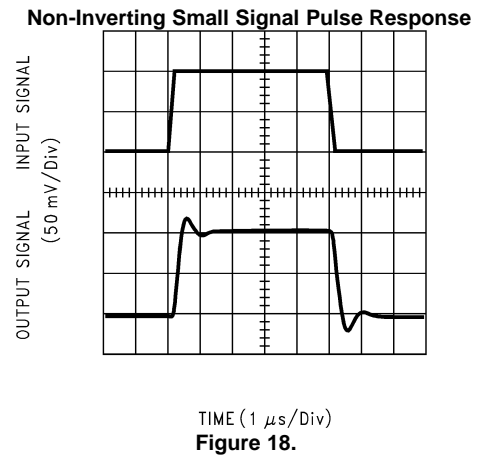
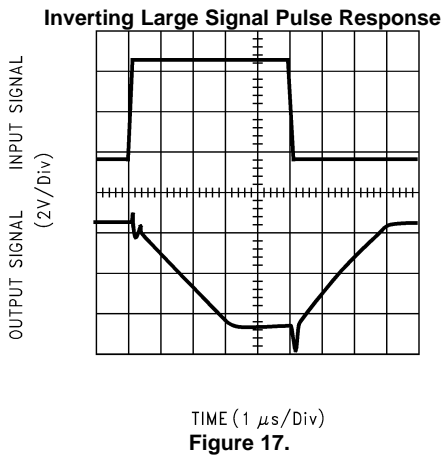
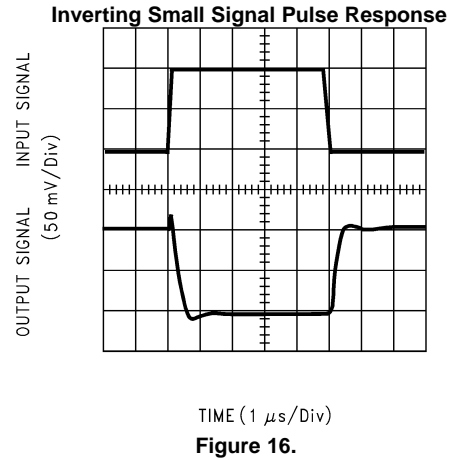
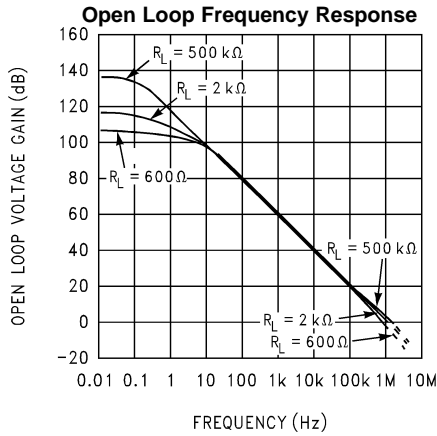

Figure 14.

Typical Performance Characteristics (continued)

$V_S = \pm 7.5V$, $T_A = 25^\circ C$, unless otherwise specified



APPLICATIONS HINTS

AMPLIFIER TOPOLOGY

The LMC6001 incorporates a novel op-amp design topology that enables it to maintain rail-to-rail output swing even when driving a large load. Instead of relying on a push-pull unity gain output buffer stage, the output stage is taken directly from the internal integrator, which provides both low output impedance and large gain. Special feed-forward compensation design techniques are incorporated to maintain stability over a wider range of operating conditions than traditional op-amps. These features make the LMC6001 both easier to design with, and provide higher speed than products typically found in this low power class.

COMPENSATING FOR INPUT CAPACITANCE

It is quite common to use large values of feedback resistance for amplifiers with ultra-low input current, like the LMC6001.

Although the LMC6001 is highly stable over a wide range of operating conditions, certain precautions must be met to achieve the desired pulse response when a large feedback resistor is used. Large feedback resistors with even small values of input capacitance, due to transducers, photodiodes, and circuit board parasitics, reduce phase margins.

When high input impedances are demanded, guarding of the LMC6001 is suggested. Guarding input lines will not only reduce leakage, but lowers stray input capacitance as well. See [PRINTED-CIRCUIT-BOARD LAYOUT FOR HIGH-IMPEDANCE WORK](#).

The effect of input capacitance can be compensated for by adding a capacitor, C_f , around the feedback resistors (as in [Figure 21](#)) such that:

$$\frac{1}{2\pi R_1 C_{IN}} \geq \frac{1}{2\pi R_2 C_f} \quad (1)$$

or

$$R_1 C_{IN} \leq R_2 C_f \quad (2)$$

Since it is often difficult to know the exact value of C_{IN} , C_f can be experimentally adjusted so that the desired pulse response is achieved. Refer to the LMC660 and LMC662 for a more detailed discussion on compensating for input capacitance.

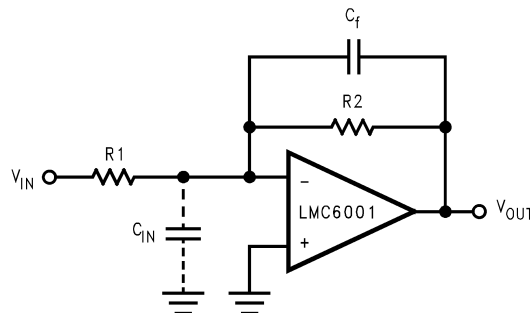

Figure 21. Cancelling the Effect of Input Capacitance

CAPACITIVE LOAD TOLERANCE

All rail-to-rail output swing operational amplifiers have voltage gain in the output stage. A compensation capacitor is normally included in this integrator stage. The frequency location of the dominant pole is affected by the resistive load on the amplifier. Capacitive load driving capability can be optimized by using an appropriate resistive load in parallel with the capacitive load. See [Typical Performance Characteristics](#).

Direct capacitive loading will reduce the phase margin of many op-amps. A pole in the feedback loop is created by the combination of the op-amp's output impedance and the capacitive load. This pole induces phase lag at the unity-gain crossover frequency of the amplifier resulting in either an oscillatory or underdamped pulse response. With a few external components, op amps can easily indirectly drive capacitive loads, as shown in [Figure 22](#).

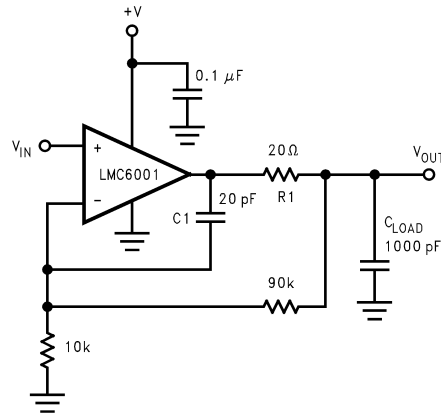

Figure 22. LMC6001 Noninverting Gain of 10 Amplifier, Compensated to Handle Capacitive Loads

In the circuit of [Figure 22](#), R1 and C1 serve to counteract the loss of phase margin by feeding the high frequency component of the output signal back to the amplifier's inverting input, thereby preserving phase margin in the overall feedback loop.

Capacitive load driving capability is enhanced by using a pullup resistor to V⁺ ([Figure 23](#)). Typically a pullup resistor conducting 500 μA or more will significantly improve capacitive load responses. The value of the pullup resistor must be determined based on the current sinking capability of the amplifier with respect to the desired output swing. Open loop gain of the amplifier can also be affected by the pullup resistor. See [DC Electrical Characteristics](#).

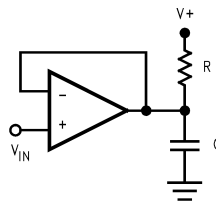

Figure 23. Compensating for Large Capacitive Loads with a Pullup Resistor

PRINTED-CIRCUIT-BOARD LAYOUT FOR HIGH-IMPEDANCE WORK

It is generally recognized that any circuit which must operate with less than 1000 pA of leakage current requires special layout of the PC board. When one wishes to take advantage of the ultra-low bias current of the LMC6001, typically less than 10 fA, it is essential to have an excellent layout. Fortunately, the techniques of obtaining low leakages are quite simple. First, the user must not ignore the surface leakage of the PC board, even though it may sometimes appear acceptably low, because under conditions of high humidity or dust or contamination, the surface leakage will be appreciable.

To minimize the effect of any surface leakage, lay out a ring of foil completely surrounding the LMC6001's inputs and the terminals of capacitors, diodes, conductors, resistors, relay terminals, etc., connected to the op-amp's inputs, as in [Figure 24](#). To have a significant effect, guard rings should be placed on both the top and bottom of the PC board. This PC foil must then be connected to a voltage which is at the same voltage as the amplifier inputs, since no leakage current can flow between two points at the same potential. For example, a PC board trace-to-pad resistance of $10^{12}\Omega$, which is normally considered a very large resistance, could leak 5 pA if the trace were a 5V bus adjacent to the pad of the input.

This would cause a 500 times degradation from the LMC6001's actual performance. If a guard ring is used and held within 1 mV of the inputs, then the same resistance of $10^{12}\Omega$ will only cause 10 fA of leakage current. Even this small amount of leakage will degrade the extremely low input current performance of the LMC6001. See [Figure 27](#) for typical connections of guard rings for standard op-amp configurations.

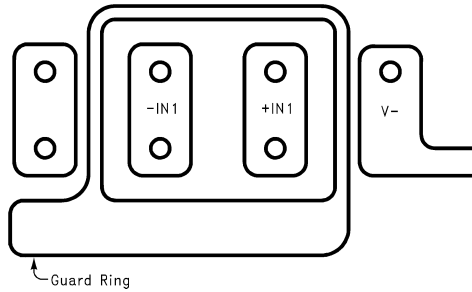

Figure 24. Examples of Guard Ring in PC Board Layout

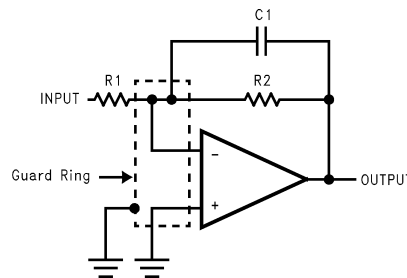

Figure 25. Inverting Amplifier

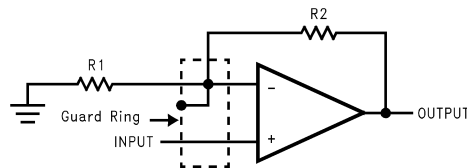

Figure 26. Non-Inverting Amplifier

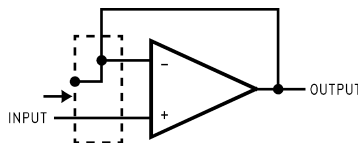
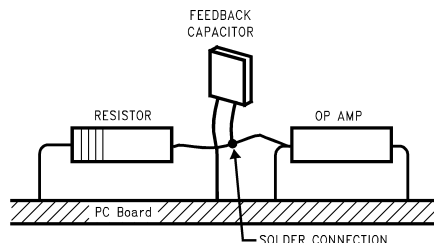

Figure 27. Typical Connections of Guard Rings

The designer should be aware that when it is inappropriate to lay out a PC board for the sake of just a few circuits, there is another technique which is even better than a guard ring on a PC board: Don't insert the amplifier's input pin into the board at all, but bend it up in the air and use only air as an insulator. Air is an excellent insulator. In this case you may have to forego some of the advantages of PC board construction, but the advantages are sometimes well worth the effort of using point-to-point up-in-the-air wiring. See [Figure 28](#).



(Input pins are lifted out of PC board and soldered directly to components. All other pins connected to PC board).

Figure 28. Air Wiring

Another potential source of leakage that might be overlooked is the device package. When the LMC6001 is manufactured, the device is always handled with conductive finger cots. This is to assure that salts and skin oils do not cause leakage paths on the surface of the package. We recommend that these same precautions be adhered to, during all phases of inspection, test and assembly.

LATCHUP

CMOS devices tend to be susceptible to latchup due to their internal parasitic SCR effects. The (I/O) input and output pins look similar to the gate of the SCR. There is a minimum current required to trigger the SCR gate lead. The LMC6001 is designed to withstand 100 mA surge current on the I/O pins. Some resistive method should be used to isolate any capacitance from supplying excess current to the I/O pins. In addition, like an SCR, there is a minimum holding current for any latchup mode. Limiting current to the supply pins will also inhibit latchup susceptibility.

Typical Applications

The extremely high input resistance, and low power consumption, of the LMC6001 make it ideal for applications that require battery-powered instrumentation amplifiers. Examples of these types of applications are hand-held pH probes, analytic medical instruments, electrostatic field detectors and gas chromatographs.

TWO OPAMP, TEMPERATURE COMPENSATED pH PROBE AMPLIFIER

The signal from a pH probe has a typical resistance between 10 M Ω and 1000 M Ω . Because of this high value, it is very important that the amplifier input currents be as small as possible. The LMC6001 with less than 25 fA input current is an ideal choice for this application.

The theoretical output of the standard Ag/AgCl pH probe is 59.16 mV/pH at 25°C with 0V out at a pH of 7.00. This output is proportional to absolute temperature. To compensate for this, a temperature compensating resistor, R1, is placed in the feedback loop. This cancels the temperature dependence of the probe. This resistor must be mounted where it will be at the same temperature as the liquid being measured.

The LMC6001 amplifies the probe output providing a scaled voltage of ± 100 mV/pH from a pH of 7. The second opamp, a micropower LMC6041 provides phase inversion and offset so that the output is directly proportional to pH, over the full range of the probe. The pH reading can now be directly displayed on a low cost, low power digital panel meter. Total current consumption will be about 1 mA for the whole system.

The micropower dual operational amplifier, LMC6042, would optimize power consumption but not offer these advantages:

1. The LMC6001A ensures a 25 fA limit on input current at 25°C.
2. The input ESD protection diodes in the LMC6042 are only rated at 500V while the LMC6001 has much more robust protection that is rated at 2000V.

The setup and calibration is simple with no interactions to cause problems.

1. Disconnect the pH probe and with R3 set to about mid-range and the noninverting input of the LMC6001 grounded, adjust R8 until the output is 700 mV.
2. Apply -414.1 mV to the noninverting input of the LMC6001. Adjust R3 for an output of 1400 mV. This completes the calibration. As real pH probes may not perform exactly to theory, minor gain and offset adjustments should be made by trimming while measuring a precision buffer solution.

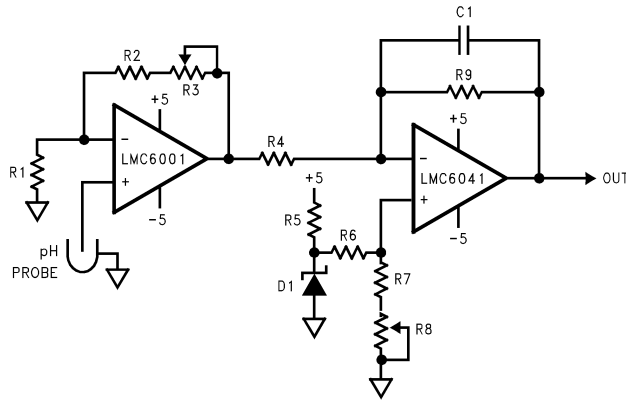

- R1 100k + 3500 ppm/°C
- R2 68.1k
- R3, 8 5k
- R4, 9 100k
- R5 36.5k
- R6 619k
- R7 97.6k
- D1 LM4040D1Z-2.5
- C1 2.2 μF

(1) Micro-ohm style 137 or similar

Figure 29. pH Probe Amplifier

ULTRA-LOW INPUT CURRENT INSTRUMENTATION AMPLIFIER

Figure 30 shows an instrumentation amplifier that features high differential and common mode input resistance (>10¹⁴Ω), 0.01% gain accuracy at A_V = 1000, excellent CMRR with 1 MΩ imbalance in source resistance. Input current is less than 20 fA and offset drift is less than 2.5 μV/°C. R₂ provides a simple means of adjusting gain over a wide range without degrading CMRR. R₇ is an initial trim used to maximize CMRR without using super precision matched resistors. For good CMRR over temperature, low drift resistors should be used.

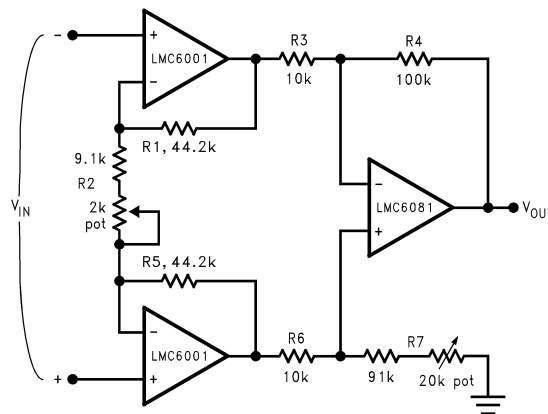

If R₁ = R₅, R₃ = R₆, and R₄ = R₇; then

$$\frac{V_{OUT}}{V_{IN}} = \frac{R_2 + 2R_1}{R_2} \times \frac{R_4}{R_3}$$

∴ A_V ≈ 100 for circuit shown (R₂ = 9.85k).

Figure 30. Instrumentation Amplifier

REVISION HISTORY

Changes from Revision F (March 2013) to Revision H	Page
<hr/> <ul style="list-style-type: none">• Changed layout of National Data Sheet to TI format	<hr/> 12

IMPORTANT NOTICE

Texas Instruments Incorporated and its subsidiaries (TI) reserve the right to make corrections, enhancements, improvements and other changes to its semiconductor products and services per JESD46, latest issue, and to discontinue any product or service per JESD48, latest issue. Buyers should obtain the latest relevant information before placing orders and should verify that such information is current and complete. All semiconductor products (also referred to herein as "components") are sold subject to TI's terms and conditions of sale supplied at the time of order acknowledgment.

TI warrants performance of its components to the specifications applicable at the time of sale, in accordance with the warranty in TI's terms and conditions of sale of semiconductor products. Testing and other quality control techniques are used to the extent TI deems necessary to support this warranty. Except where mandated by applicable law, testing of all parameters of each component is not necessarily performed.

TI assumes no liability for applications assistance or the design of Buyers' products. Buyers are responsible for their products and applications using TI components. To minimize the risks associated with Buyers' products and applications, Buyers should provide adequate design and operating safeguards.

TI does not warrant or represent that any license, either express or implied, is granted under any patent right, copyright, mask work right, or other intellectual property right relating to any combination, machine, or process in which TI components or services are used. Information published by TI regarding third-party products or services does not constitute a license to use such products or services or a warranty or endorsement thereof. Use of such information may require a license from a third party under the patents or other intellectual property of the third party, or a license from TI under the patents or other intellectual property of TI.

Reproduction of significant portions of TI information in TI data books or data sheets is permissible only if reproduction is without alteration and is accompanied by all associated warranties, conditions, limitations, and notices. TI is not responsible or liable for such altered documentation. Information of third parties may be subject to additional restrictions.

Resale of TI components or services with statements different from or beyond the parameters stated by TI for that component or service voids all express and any implied warranties for the associated TI component or service and is an unfair and deceptive business practice. TI is not responsible or liable for any such statements.

Buyer acknowledges and agrees that it is solely responsible for compliance with all legal, regulatory and safety-related requirements concerning its products, and any use of TI components in its applications, notwithstanding any applications-related information or support that may be provided by TI. Buyer represents and agrees that it has all the necessary expertise to create and implement safeguards which anticipate dangerous consequences of failures, monitor failures and their consequences, lessen the likelihood of failures that might cause harm and take appropriate remedial actions. Buyer will fully indemnify TI and its representatives against any damages arising out of the use of any TI components in safety-critical applications.

In some cases, TI components may be promoted specifically to facilitate safety-related applications. With such components, TI's goal is to help enable customers to design and create their own end-product solutions that meet applicable functional safety standards and requirements. Nonetheless, such components are subject to these terms.

No TI components are authorized for use in FDA Class III (or similar life-critical medical equipment) unless authorized officers of the parties have executed a special agreement specifically governing such use.

Only those TI components which TI has specifically designated as military grade or "enhanced plastic" are designed and intended for use in military/aerospace applications or environments. Buyer acknowledges and agrees that any military or aerospace use of TI components which have **not** been so designated is solely at the Buyer's risk, and that Buyer is solely responsible for compliance with all legal and regulatory requirements in connection with such use.

TI has specifically designated certain components as meeting ISO/TS16949 requirements, mainly for automotive use. In any case of use of non-designated products, TI will not be responsible for any failure to meet ISO/TS16949.

Products

Audio	www.ti.com/audio
Amplifiers	amplifier.ti.com
Data Converters	dataconverter.ti.com
DLP® Products	www.dlp.com
DSP	dsp.ti.com
Clocks and Timers	www.ti.com/clocks
Interface	interface.ti.com
Logic	logic.ti.com
Power Mgmt	power.ti.com
Microcontrollers	microcontroller.ti.com
RFID	www.ti-rfid.com
OMAP Applications Processors	www.ti.com/omap
Wireless Connectivity	www.ti.com/wirelessconnectivity

Applications

Automotive and Transportation	www.ti.com/automotive
Communications and Telecom	www.ti.com/communications
Computers and Peripherals	www.ti.com/computers
Consumer Electronics	www.ti.com/consumer-apps
Energy and Lighting	www.ti.com/energy
Industrial	www.ti.com/industrial
Medical	www.ti.com/medical
Security	www.ti.com/security
Space, Avionics and Defense	www.ti.com/space-avionics-defense
Video and Imaging	www.ti.com/video

TI E2E Community

e2e.ti.com