

Supply

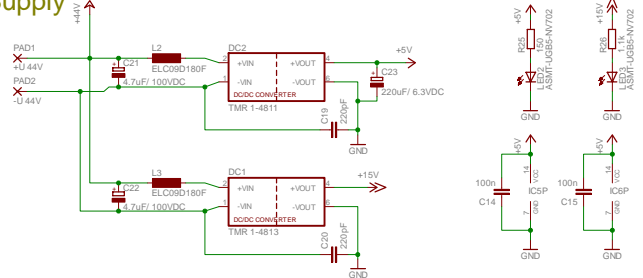

Ref. Speed

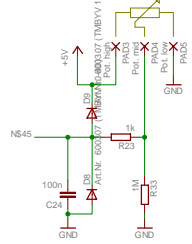

Controller

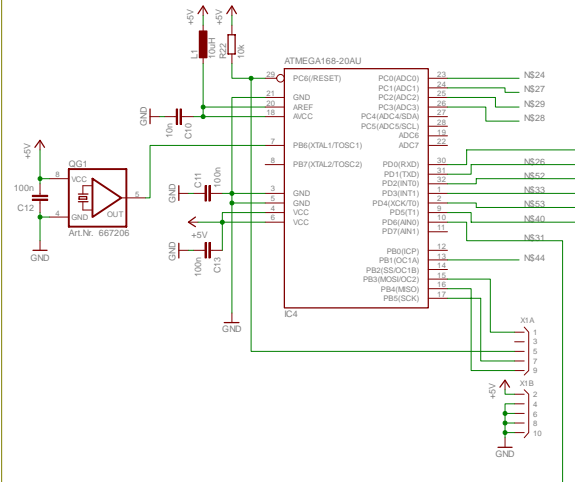

PWM

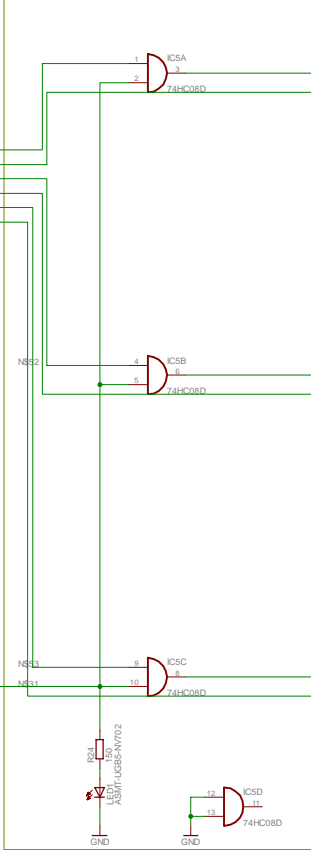

Phase U

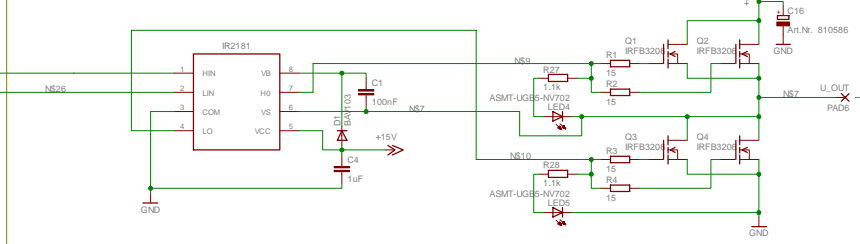

Phase V

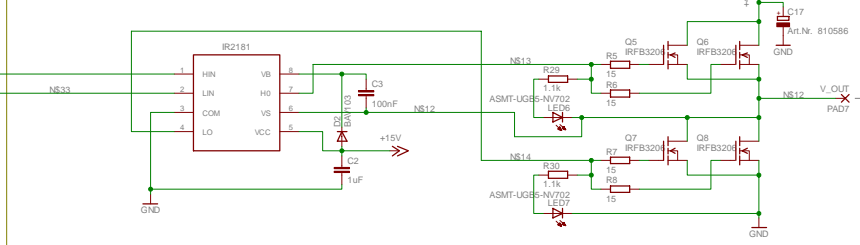

Phase W

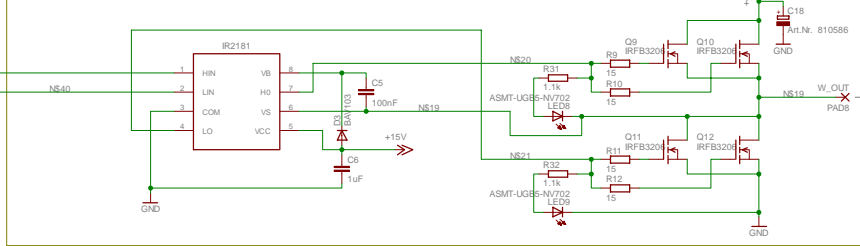

BEMF

