

Introduction

This reference guide supplements TN1205, [Using User Flash Memory and Hardened Control Functions in MachXO2™ Devices Usage Guide](#) which explains the software usage. In this document you will find:

- WISHBONE Protocol
- EFB Register Map
- Command Sequences
- Examples

As an overview, the MachXO2 FPGA family combines a high-performance, low power, FPGA fabric with built-in, hardened control functions and on-chip User Flash Memory (UFM). The hardened control functions ease design implementation and save general purpose resources such as LUTs, registers, clocks and routing. The hardened control functions are physically located in the Embedded Function Block (EFB). All MachXO2 devices include an EFB module. The EFB block includes the following control functions:

- Two I²C Cores
- One SPI Core
- One 16-bit Timer/Counter
- Interface to Flash Memory which includes:
 - User Flash Memory for MachXO2-640 and higher densities
 - Configuration Logic
- Interface to Dynamic PLL configuration settings
- Interface to On-chip Power Controller through I²C and SPI

Figure 17-1 shows the EFB architecture and the interface to the FPGA core logic.

Figure 17-1. Embedded Function Block (EFB)

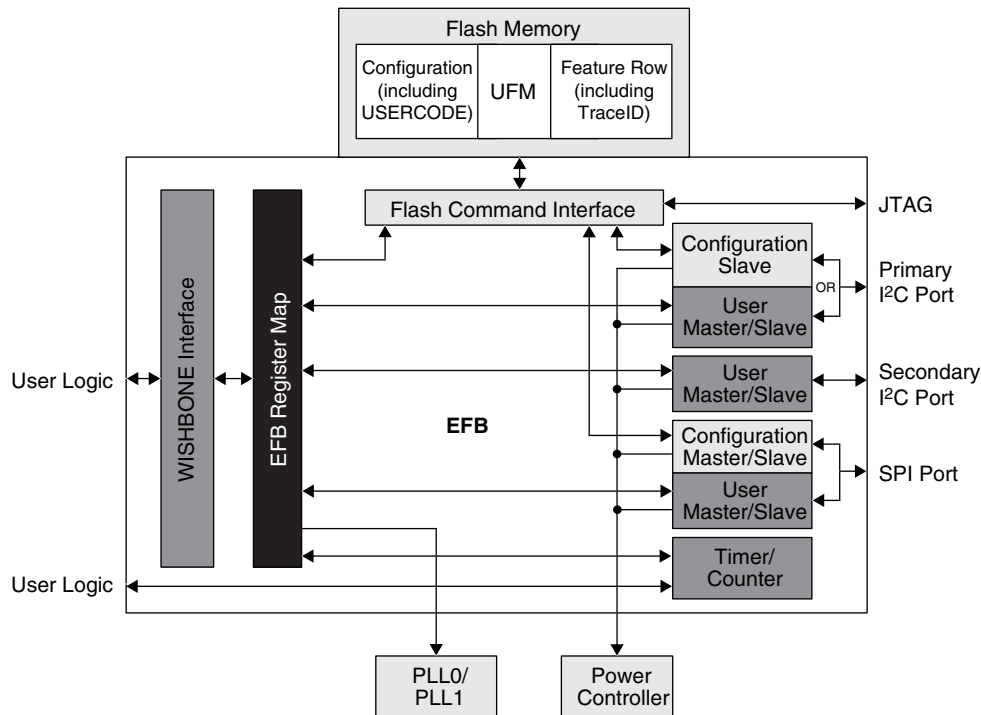

EFB Register Map

The EFB module has a Register Map to allow the service of the hardened functions through the WISHBONE bus interface read/write operations. Each hardened function has dedicated 8-bit Data and Control registers, with the exception of the Flash Memory (UFM/Configuration), which are accessed through the same set of registers. Table 17-1 documents the register map of the EFB module. The PLL registers are located in the MachXO2 PLL modules, but they are accessed through EFB WISHBONE read/write cycles.

Table 17-1. EFB Register Map

Address (Hex)	Hardened Function
0x00-0x1F	PLL0 Dynamic Access1
0x20-0x3F	PLL1 Dynamic Access1
0x40-0x49	I ² C Primary
0x4A-0x53	I ² C Secondary
0x54-0x5D	SPI
0x5E-0x6F	Timer/Counter
0x70-0x75	Flash Memory (UFM/Configuration)
0x76-0x77	EFB Interrupt Source

1. There can be up to two PLLs in a MachXO2 device. PLL0 has an address range from 0x00 to 0x1F. PLL1 (if present) has an address range from 0x20 to 0x3F. Reference TN1199, [MachXO2 sysCLOCK PLL Design and Usage Guide](#), for details on PLL configuration registers and recommended usage.

Address spaces that are not defined in Table 17-1 are invalid and will result in non-deterministic results. It is the responsibility of the designer to ensure valid addresses are presented to the EFB WISHBONE slave interface.

WISBONE Bus Interface

The WISHBONE Bus in the MachXO2 is compliant with the WISHBONE standard from OpenCores. It provides connectivity between FPGA user logic and the EFB functional blocks. The user can implement a WISHBONE Master interface to interact with the EFB WISHBONE slave interface or a LatticeMico8™ soft processor core can be used to interact with the EFB WISHBONE.

The block diagram in Figure 17-2 shows the supported WISHBONE bus signals between the FPGA core and the EFB. Table 17-2 provides a detailed definition of the supported signals.

Figure 17-2. WISHBONE Bus Interface Between the FPGA Core and the EFB Module

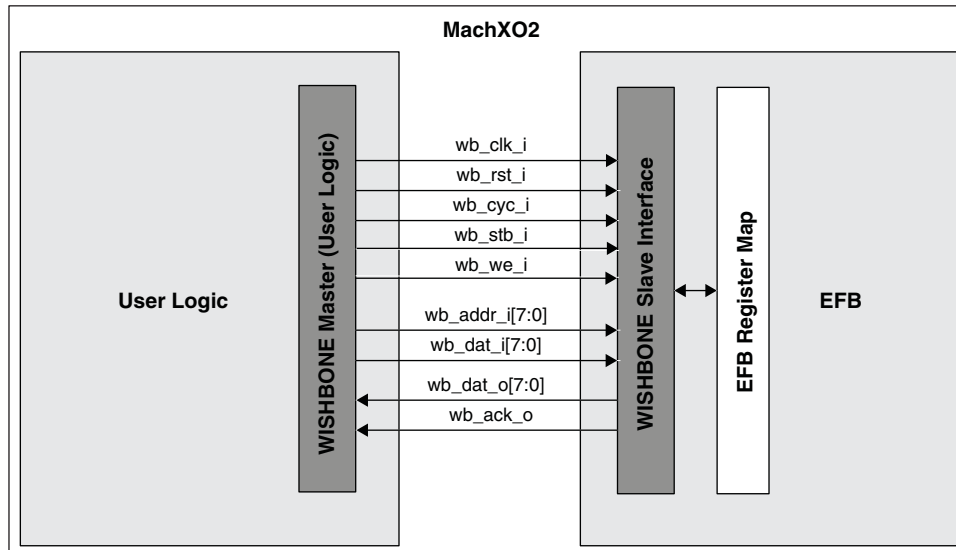

Table 17-2. WISHBONE Slave Interface Signals of the EFB Module

Signal Name	I/O	Width	Description
wb_clk_i	Input	1	Positive edge clock used by WISHBONE Interface registers and hardened functions within the EFB module. Supports clock speeds up to 133 MHz.
wb_rst_i	Input	1	Active-high, synchronous reset signal that will only reset the WISHBONE interface logic. This signal will not affect the contents of any registers. It will only affect ongoing bus transactions. Wait 1us after de-assertion before starting any subsequent WISHBONE transactions.
wb_cyc_i	Input	1	Active-high signal, asserted by the WISHBONE master, indicates a valid bus cycle is present on the bus.
wb_stb_i	Input	1	Active-high strobe, input signal, indicating the WISHBONE slave is the target for the current transaction on the bus. The EFB module asserts an acknowledgment in response to the assertion of the strobe.
wb_we_i	Input	1	Level sensitive Write/Read control signal. Low indicates a Read operation, and High indicates a Write operation.
wb_adr_i	Input	8	8-bit wide address used to select a specific register from the register map of the EFB module.
wb_dat_i	Input	8	8-bit input data path used to write a byte of data to a specific register in the register map of the EFB module.
wb_dat_o	Output	8	8-bit output data path used to read a byte of data from a specific register in the register map of the EFB module.
wb_ack_o	Output	1	Active-high, transfer acknowledge signal asserted by the EFB module, indicating the requested transfer is acknowledged.

To interface to the EFB you must create a WISHBONE Master controller in the User Logic. In a multiple-Master configuration, the WISHBONE Master outputs are multiplexed in a user-defined arbiter. A LatticeMico8 soft processor can also be utilized along with the Mico System Builder (MSB) platform which can implement multi-Master bus configurations. If two Masters request the bus in the same cycle, only the outputs of the arbitration winner reach the Slave interface.

The EFB WISHBONE bus supports the “Classic” version of the WISHBONE standard. Given that the WISHBONE bus is an open source standard, not all features of the standard are implemented or required:

- Tags are not supported in the WISHBONE Slave interface of the EFB module. Given that the EFB is a hardened block, these signals cannot be added by the user.
- The Slave WISHBONE bus interface of the EFB module does not require the byte select signals (`sel_i` or `sel_o`), since the data bus is only a single byte wide.
- The EFB WISHBONE slave interface does not support the optional error and retry access termination signals. If the slave receives an access to an invalid address, it will simply respond by asserting `wb_ack_o` signal. It is the responsibility of the user to stay within the valid address range.

WISHBONE Write Cycle

Figure 17-3 shows the waveform of a Write cycle from the perspective of the EFB WISHBONE Slave interface. During a single Write cycle, only one byte of data is written to the EFB block from the WISHBONE Master. A Write operation requires a minimum three clock cycles.

On clock Edge 0, the Master updates the address, data and asserts control signals. During this cycle:

- The Master updates the address on the `wb_adr_i[7:0]` address lines
- Updates the data that will be written to the EFB block, `wb_dat_i[7:0]` data lines
- Asserts the write enable `wb_we_i` signal, indicating a write cycle
- Asserts the `wb_cyc_i` to indicate the start of the cycle
- Asserts the `wb_stb_i`, selecting a specific slave module

On clock Edge 1, the EFB WISHBONE Slave decodes the input signals presented by the master. During this cycle:

- The Slave decodes the address presented on the `wb_adr_i[7:0]` address lines
- The Slave prepares to latch the data presented on the `wb_dat_i[7:0]` data lines
- The Master waits for an active-high level on the `wb_ack_o` line and prepares to terminate the cycle on the next clock edge, if an active-high level is detected on the `wb_ack_o` line
- The EFB may insert wait states before asserting `wb_ack_o`, thereby allowing it to throttle the cycle speed. Any number of wait states may be added
- The Slave asserts `wb_ack_o` signal

The following occurs on clock Edge 2:

- The Slave latches the data presented on the `wb_dat_i[7:0]` data lines
- The Master de-asserts the strobe signal, `wb_stb_i`, the cycle signal, `wb_cyc_i`, and the write enable signal, `wb_we_i`
- The Slave de-asserts the acknowledge signal, `wb_ack_o`, in response to the Master de-assertion of the strobe signal

Figure 17-3. WISHBONE Bus Write Operation

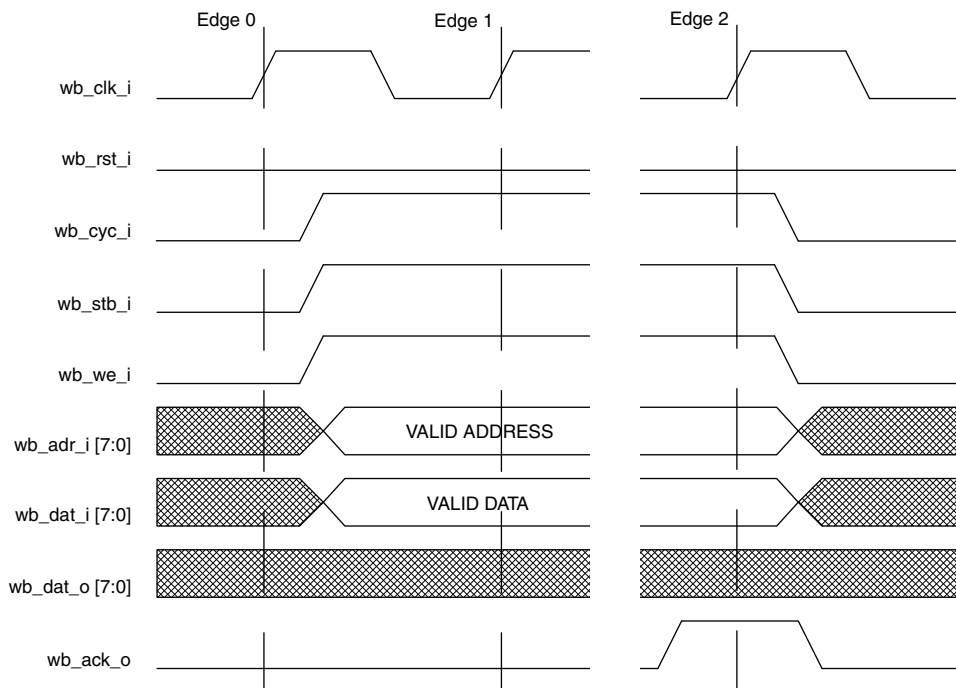

WISHBONE Read Cycle

Figure 17-4 shows the waveform of a Read cycle from the perspective of the EFB WISHBONE Slave interface. During a single Read cycle, only one byte of data is read from the EFB block by the WISHBONE master. A Read operation requires a minimum three clock cycles.

On clock Edge 0, the Master updates the address, data and asserts control signals. The following occurs during this cycle:

- The Master updates the address on the `wb_adr_i[7:0]` address lines
- De-asserts the write enable `wb_we_i` signal, indicating a Read cycle
- Asserts the `wb_cyc_i` to indicate the start of the cycle
- Asserts the `wb_stb_i`, selecting a specific Slave module

On clock Edge 1, the EFB WISHBONE slave decodes the input signals presented by the master. The following occurs during this cycle:

- The Slave decodes the address presented on the `wb_adr_i[7:0]` address lines
- The Master prepares to latch the data presented on `wb_dat_o[7:0]` data lines from the EFB WISHBONE slave on the following clock edge
- The Master waits for an active-high level on the `wb_ack_o` line and prepares to terminate the cycle on the next clock edge, if an active-high level is detected on the `wb_ack_o` line
- The EFB may insert wait states before asserting `wb_ack_o`, thereby allowing it to throttle the cycle speed. Any number of wait states may be added.
- The Slave presents valid data on the `wb_dat_o[7:0]` data lines
- The Slave asserts `wb_ack_o` signal in response to the strobe, `wb_stb_i` signal

The following occurs on clock Edge 2:

- The Master latches the data presented on the wb_dat_o[7:0] data lines
- The Master de-asserts the strobe signal, wb_stb_i, and the cycle signal, wb_cyc_i
- The Slave de-asserts the acknowledge signal, wb_ack_o, in response to the master de-assertion of the strobe signal

Figure 17-4. WISHBONE Bus Read Operation

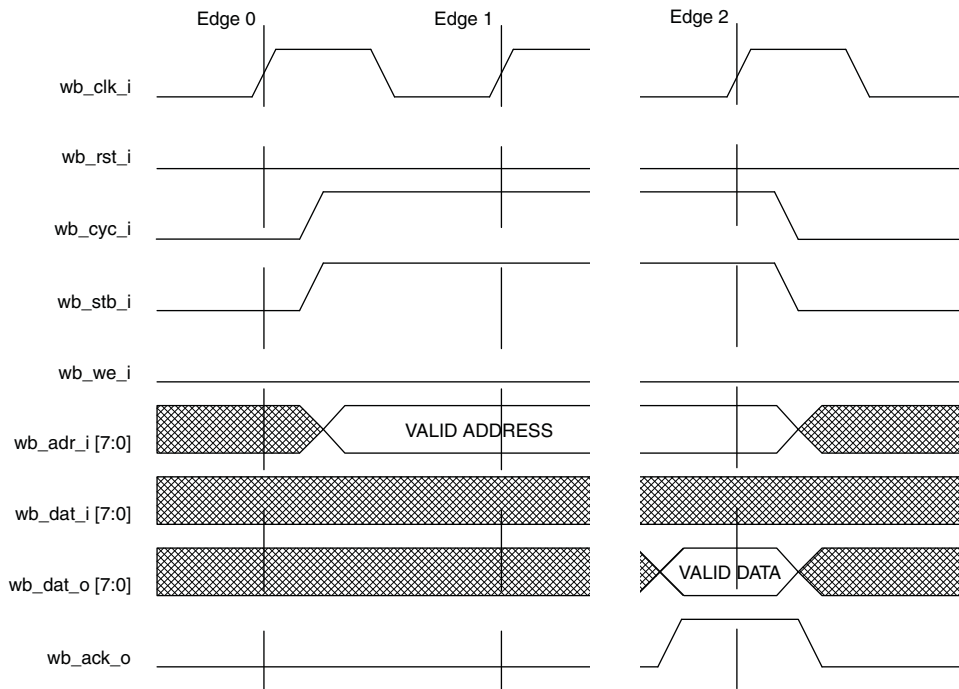

WISHBONE Reset Cycle

Figure 17-5 shows the waveform of the synchronous **wb_rst_i** signal. Asserting the reset signal will only reset the WISHBONE interface logic. This signal will not affect the contents of any registers in the EFB register map. It will only affect ongoing bus transactions.

Figure 17-5. EFB WISHBONE Interface Reset

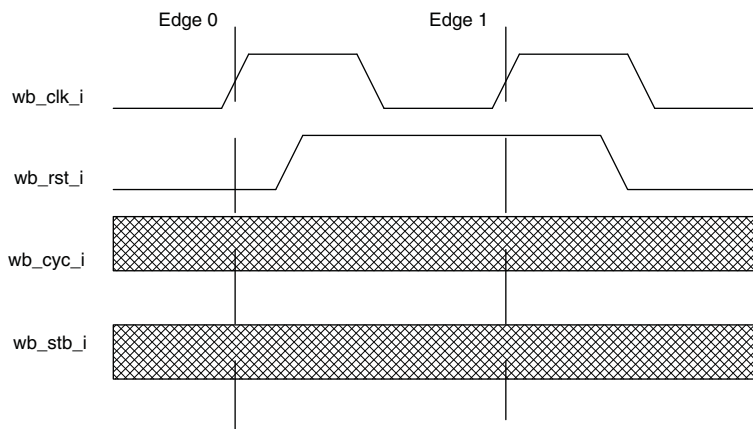

The **wb_rst_i** signal can be asserted for any length of time.

Hardened I²C IP Cores

I²C is a widely used two-wire serial bus for communication between devices on the same board. Every MachXO2 device contains two hardened I²C IP cores designated as the “Primary” and “Secondary” I²C IP cores. Either of the two cores can be operated as an I²C Master or as an I²C Slave. The difference between the two cores is that the Primary core has pre-assigned I/O pins while the ports of the secondary core can be assigned by designers to any general purpose I/O. In addition, the Primary I²C core can be used for accessing the User Flash Memory (UFM) and for programming the Configuration Flash. However, the Primary I²C port cannot be used for both UFM/Config access and user functions in the same design.

I²C Registers

Both I²C cores communicate with the EFB WISHBONE interface through a set of control, command, status and data registers. Table 17-3 shows the register names and their functions. These registers are a subset of the EFB register map.

Table 17-3. I²C Registers

I ² C Primary Register Name	I ² C Secondary Register Name	Register Function	Address I ² C Primary	Address I ² C Secondary	Access
I2C_1_CR	I2C_2_CR	Control	0x40	0x4A	Read/Write
I2C_1_CMDR	I2C_2_CMDR	Command	0x41	0x4B	Read/Write
I2C_1_BR0	I2C_2_BR0	Clock Pre-scale	0x42	0x4C	Read/Write
I2C_1_BR1	I2C_2_BR1	Clock Pre-scale	0x43	0x4D	Read/Write
I2C_1_TXDR	I2C_2_TXDR	Transmit Data	0x44	0x4E	Write
I2C_1_SR	I2C_2_SR	Status	0x45	0x4F	Read
I2C_1_GCDR	I2C_2_GCDR	General Call	0x46	0x50	Read
I2C_1_RXDR	I2C_2_RXDR	Receive Data	0x47	0x51	Read
I2C_1_IRQ	I2C_2_IRQ	IRQ	0x48	0x52	Read/Write
I2C_1_IRQEN	I2C_2_IRQEN	IRQ Enable	0x49	0x53	Read/Write

Note: Unless otherwise specified, all reserved bits in writable registers shall be written '0'.

Table 17-4. I²C Control (Primary/Secondary)

I2C_1_CR / I2C_2_CR								0x40/0x4A	
Bit	7	6	5	4	3	2	1	0	
Name	I2CEN	GCEN	WKUPEN	(Reserved)	SDA_DEL_SEL[1:0]		(Reserved)		
Default	0	0	0	0	0	0	0	0	
Access	R/W	R/W	R/W	—	R/W	R/W	—	—	

Note: A write to this register will cause the I²C core to reset.

I2CEN I²C System Enable Bit – This bit enables the I²C core functions. If I2CEN is cleared, the I²C core is disabled and forced into idle state.

- 0: I²C function is disabled
- 1: I²C function is enabled

GCEN Enable bit for General Call Response – Enables the general call response in slave mode.

- 0: Disable
- 1: Enable

The General Call address is defined as 0000000 and works with either 7- or 10-bit addressing

WKUPEN Wake-up from Standby/Sleep (by Slave Address matching) Enable Bit – When this bit is enabled the, I²C core can send a wake-up signal to the on-chip power manager to wake the device up from standby/sleep. The wake-up function is activated when the MachXO2 Slave Address is matched during standby/sleep mode.

- 0: Disable
- 1: Enable

SDA_DEL_SEL[1:0] SDA Output Delay (Tdel) Selection (see Figure 17-15)

- 00: 300ns
- 01: 150ns
- 10: 75ns
- 11: 0ns

Table 17-5. I²C Command (Pri/Sec)

I2C_1_CMDR / I2C_2_CMDR							0x41/0x4B	
Bit	7	6	5	4	3	2	1	0
Name	STA	STO	RD	WR	ACK	CKSDIS	(Reserved)	
Default	0	0	0	0	0	1	0	0
Access	R/W	R/W	R/W	R/W	R/W	R/W	—	—

STA Generate START (or Repeated START) condition (Master operation)

STO Generate STOP condition (Master operation)

RD Indicate Read from slave (Master operation)

WR Indicate Write to slave (Master operation)

ACK Acknowledge Option – when receiving, ACK transmission selection

- 0: Send ACK
- 1: Send NACK

CKSDIS Clock Stretching Disable.

Clock stretching is not supported in this device. Please refer to Lattice Product Change Notice (PCN) #10A-13 for further information.

This bit must be set to '1' for all writes to this register.

Table 17-6. I²C Clock Prescale 0 (Primary/Secondary)

I2C_1_BR0 / I2C_2_BR0								0x42/0x4C
Bit	7	6	5	4	3	2	1	0
Name	I2C_PRESCALE[7:0]							
Default ¹	0	0	0	0	0	0	0	0
Access	R/W	R/W	R/W	R/W	R/W	R/W	R/W	R/W

1. Hardware default value may be overridden by EFB component instantiation parameters. See discussion below.

Table 17-7. I²C Register Clock Prescale 1 (Primary/Secondary)

I2C_1_BR1 / I2C_2_BR1								0x43/0x4D
Bit	7	6	5	4	3	2	1	0
Name	(Reserved)						I2C_PRESCALE[9:8]	
Default ¹	0	0	0	0	0	0	0	0
Access	—	—	—	—	—	—	R/W	R/W

1. Hardware default value may be overridden by EFB component instantiation parameters. See discussion below.

I2C_PRESCALE[9:0] I²C Clock Prescale value. A write operation to I2C_BR [9:8] will cause an I²C core reset. The WISHBONE clock frequency is divided by (I2C_PRESCALE*4) to produce the Master I²C clock frequency supported by the I²C bus (50KHz, 100KHz, 400KHz).

Note: Different from transmitting a Master, the practical limit for Slave I²C bus speed support is (WISHBONE clock)/2048. For example, the maximum WISHBONE clock frequency to support a 50 KHz Slave I²C operation is 102 MHz.

Note: The digital value is calculated by IPexpress™ when the I²C core is configured in the I²C tab of the EFB GUI. The calculation is based on the WISHBONE Clock Frequency and the I²C Frequency, both entered by the user. The digital value of the divider is programmed in the MachXO2 device during device programming. After power-up or device reconfiguration, the data is loaded onto the I2C_1_BR1/0 and I2C_2_BR1/0 registers.

Registers I2C_1_BR1/0 and I2C_2_BR1/0 have Read/Write access from the WISHBONE interface. Designers can update these clock pre-scale registers dynamically during device operation; however, care must be taken to not violate the I²C bus frequencies.

Table 17-8. I²C Transmit Data Register (Primary/Secondary)

I2C_1_TXDR / I2C_2_TXDR								0x44/0x4E
Bit	7	6	5	4	3	2	1	0
Name	I2C_Transmit_Data[7:0]							
Default	0	0	0	0	0	0	0	0
Access	W	W	W	W	W	W	W	W

I2C_Transmit_Data[7:0] I²C Transmit Data. This register holds the byte that will be transmitted on the I²C bus during the Write Data phase. Bit 0 is the LSB and will be transmitted last. When transmitting the slave address, Bit 0 represents the Read/Write bit.

Table 17-9. I²C Status (Primary/Secondary)

I2C_1_SR / I2C_2_SR								0x45/0x4F
Bit	7	6	5	4	3	2	1	0
Name	TIP ¹	BUSY ¹	RARC	SRW	ARBL	TRRDY	TROE	HGC
Default	—	—	—	—	—	—	—	—
Access	R	R	R	R	R	R	R	R

1. These bits exhibit 0.5 SCK period latency before valid in R1 devices. For more details on the R1 to Standard migration refer to AN8086, [Designing for Migration from MachXO2-1200-R1 to Standard \(Non-R1\) Devices](#).

- TIP** Transmit In Progress. The current data byte is being transferred. Note that the TIP flag will suffer one-half SCL cycle latency right after the START condition because of the signal synchronization. Also note that this bit could be high after configuration wake-up and before the first valid I²C transfer start (when BUSY is low), and it is not indicating byte in transfer, but an invalid indicator.

 - 1: Byte transfer in progress
 - 0: Byte transfer complete
- BUSY** I²C Bus busy. The I²C bus is involved in transaction. This is set at START condition and cleared at STOP. Note only when this bit is set should all other I²C SR bits be treated as valid indicators for a valid transfer.

 - 1: I²C bus busy
 - 0: I²C bus not busy
- RARC** Received Acknowledge. An acknowledge response from the addressed slave (during master write) or from receiving master (during master read) was received.

 - 1: No acknowledge received
 - 0: Acknowledge received
- SRW** Slave Read/Write. Indicates transmit or receive mode.

 - 1: Master receiving / slave transmitting
 - 0: Master transmitting / slave receiving
- ARBL** Arbitration Lost. The core has lost arbitration in Master mode. This bit is capable of generating an interrupt.

 - 1: Arbitration Lost
 - 0: Normal

- TRRDY** Transmitter or Receiver Ready. The I²C Transmit Data register is ready to receive transmit data, or the I²C Receive Data Register contains receive data (dependent upon master/slave mode and SRW status). This bit is capable of generating an interrupt.
- 1: Transmitter or Receiver is ready
 - 0: Transmitter or Receiver is not ready
- TROE** Transmitter/Receiver Overrun Error or NACK received. A transmit or receive overrun error has occurred (dependent upon master/slave mode and SRW status), or a No Acknowledge was received (only when RARC also set). This bit is capable of generating an interrupt.
- 1: Transmitter or Receiver Overrun detected or NACK received
 - 0: Normal
- HGC** Hardware General Call Received. A hardware general call has been received in slave mode. The corresponding command byte will be available in the General Call Data Register. This bit is capable of generating an interrupt.
- 1: General Call Received in slave mode
 - 0: Normal

Table 17-10. I²C General Call Data Register (Primary/Secondary)

I2C_1_GCDR / I2C_2_GCDR								0x46/0x50
Bit	7	6	5	4	3	2	1	0
Name	I2C_GC_Data[7:0]							
Default	—	—	—	—	—	—	—	—
Access	R	R	R	R	R	R	R	R

I2C_GC_Data[7:0] I²C General Call Data. This register holds the second (command) byte of the General Call transaction on the I²C bus.

Table 17-11. I²C Receive Data Register (Primary/Secondary)

I2C_1_RXDR / I2C_2_RXDR								0x47/0x51
Bit	7	6	5	4	3	2	1	0
Name	I2C_Receive_Data[7:0]							
Default	—	—	—	—	—	—	—	—
Access	R	R	R	R	R	R	R	R

I2C_Receive_Data[7:0] I²C Receive Data. This register holds the byte captured from the I²C bus during the Read Data phase. Bit 0 is LSB and was received last.

Table 17-12. I²C Interrupt Status (Primary/Secondary)

I2C_1_IRQ / I2C_2_IRQ								0x48/0x52	
Bit	7	6	5	4	3	2	1	0	
Name	(Reserved)				IRQARBL	IRQTRRDY	IRQTROE	IRQHGC	
Default	—	—	—	—	—	—	—	—	
Access	—	—	—	—	R/W	R/W	R/W	R/W	

- IRQARBL** Interrupt Status for Arbitration Lost.
 When enabled, indicates ARBL was asserted. Write a ‘1’ to this bit to clear the interrupt.
 1: Arbitration Lost Interrupt
 0: No interrupt
- IRQTRRDY** Interrupt Status for Transmitter or Receiver Ready.
 When enabled, indicates TRRDY was asserted. Write a ‘1’ to this bit to clear the interrupt.
 1: Transmitter or Receiver Ready Interrupt
 0: No interrupt
- IRQTROE** Interrupt Status for Transmitter/Receiver Overrun or NACK received.
 When enabled, indicates TROE was asserted. Write a ‘1’ to this bit to clear the interrupt.
 1: Transmitter or Receiver Overrun or NACK received Interrupt
 0: No interrupt
- IRQHGC** Interrupt Status for Hardware General Call Received.
 When enabled, indicates HGC was asserted. Write a ‘1’ to this bit to clear the interrupt.
 1: General Call Received in slave mode Interrupt
 0: No interrupt

Table 17-13. I²C Interrupt Enable (Primary/Secondary)

I2C_1_IRQEN / I2C_2_IRQEN								0x49/0x53	
Bit	7	6	5	4	3	2	1	0	
Name	(Reserved)				IRQARBLEN	IRQTRRDYEN	IRQTROEEN	IRQHGCEN	
Default	0	0	0	0	0	0	0	0	
Access	—	—	—	—	R/W	R/W	R/W	R/W	

- IRQARBLEN** Interrupt Enable for Arbitration Lost
 1: Interrupt generation enabled
 0: Interrupt generation disabled
- IRQTRRDYEN** Interrupt Enable for Transmitter or Receiver Ready
 1: Interrupt generation enabled
 0: Interrupt generation disabled
- IRQTROEEN** Interrupt Enable for Transmitter/Receiver Overrun or NACK Received
 1: Interrupt generation enabled
 0: Interrupt generation disabled
- IRQHGCEN** Interrupt Enable for Hardware General Call Received
 1: Interrupt generation enabled
 0: Interrupt generation disabled

Figure 17-6 shows a flow diagram for controlling Master I²C reads and writes initiated via the WISHBONE interface. The following sequence is for the Primary I²C but the same sequence applies to the Secondary I²C.

Figure 17-6. I²C Master Read/Write Example (via WISHBONE)

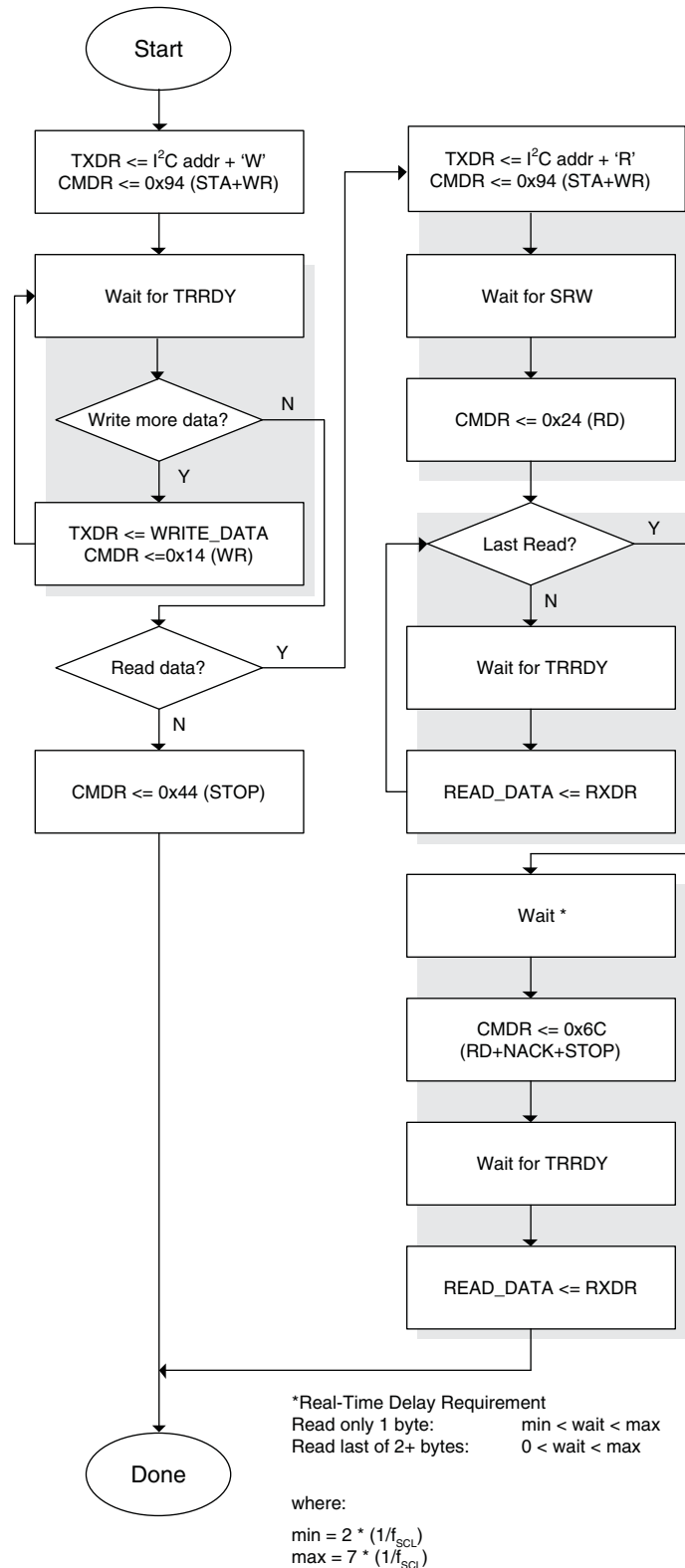
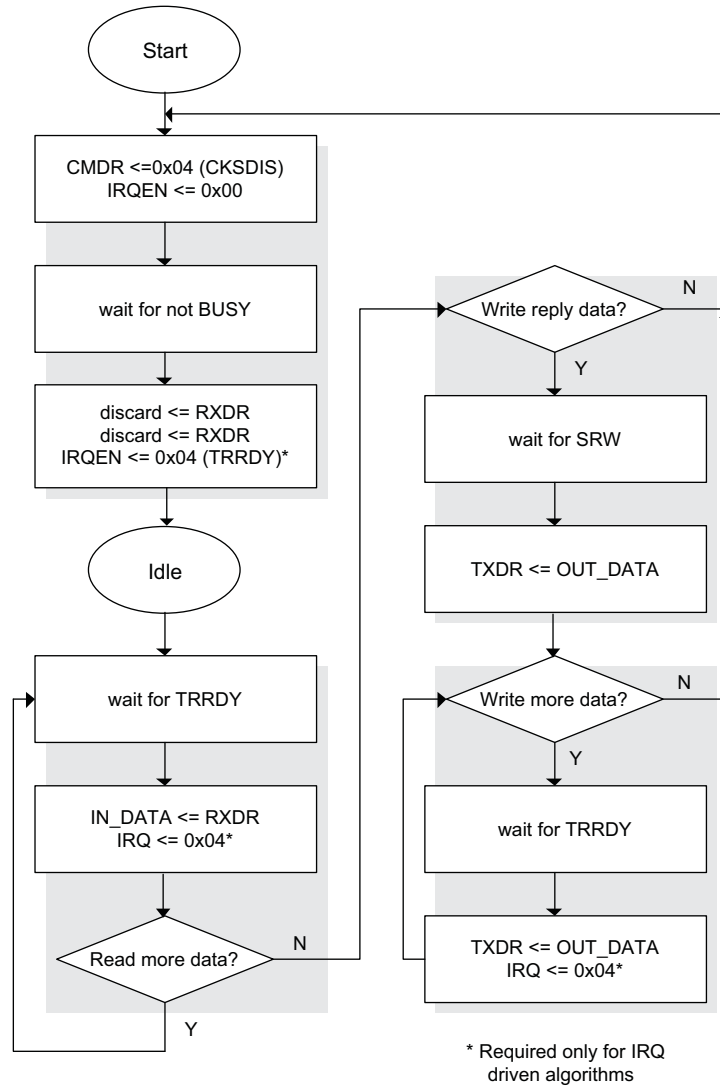

Figure 17-7 shows a flow diagram for reading and writing from an I²C Slave device via the WISHBONE interface. The following sequence is for the Primary I²C but the same sequence applies to the Secondary I²C.

Figure 17-7. I²C Slave Read/Write Example (via WISHBONE)



Typical I²C Transactions

Figures 17-8, 17-9, and 17-10 illustrate typical User I²C bus protocol transactions that are supported by the Master and Slave flows shown in Figures 17-6 and 17-7. Additionally, the figures below reference typical sysConfig Configuration commands structures.

Figure 17-8. Simple I²C Command (e.g. ISC_ERASE)

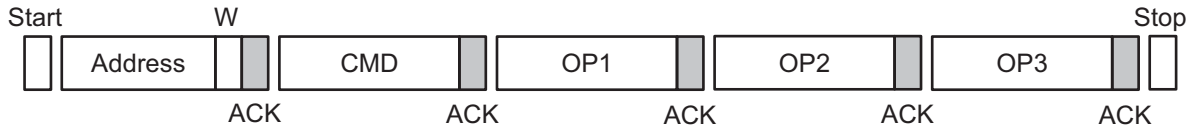

Figure 17-9. I²C Command with Write Data (e.g. LSC_PROG_INCR_NV)

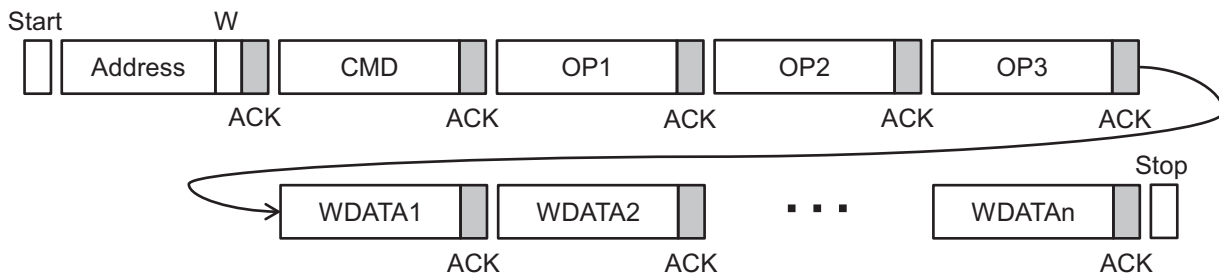
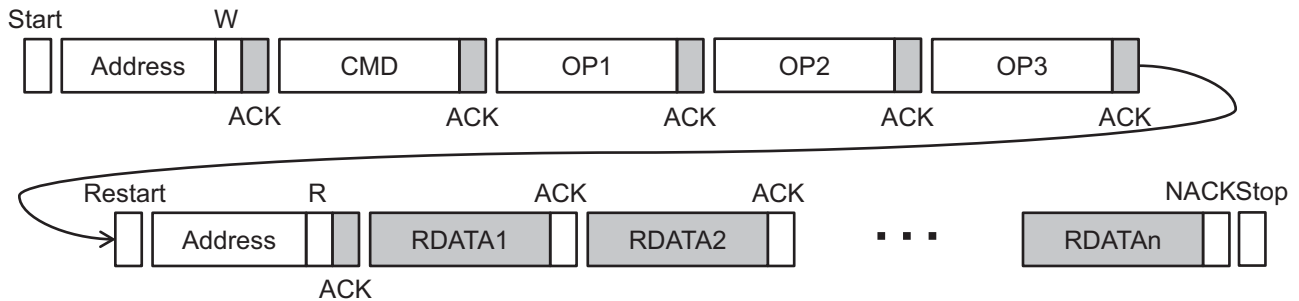

Figure 17-10. I²C Command with Read Data (e.g. LSC_READ_STATUS)



I²C Functional Waveforms

Figure 17-11. EFB Master – I²C Write

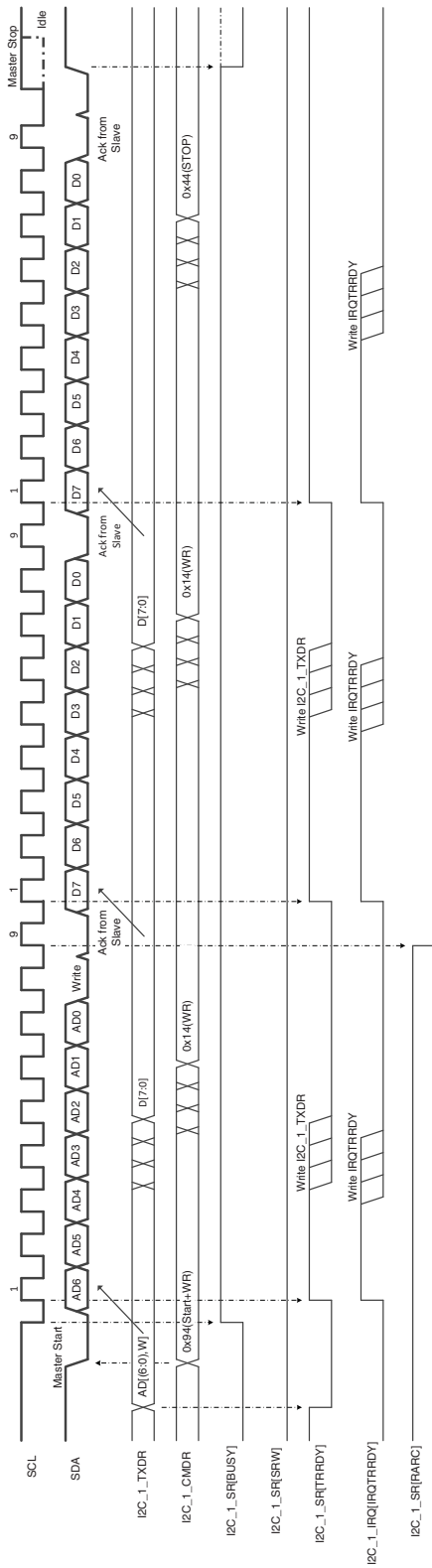

Figure 17-12. EFB Master – I²C Read

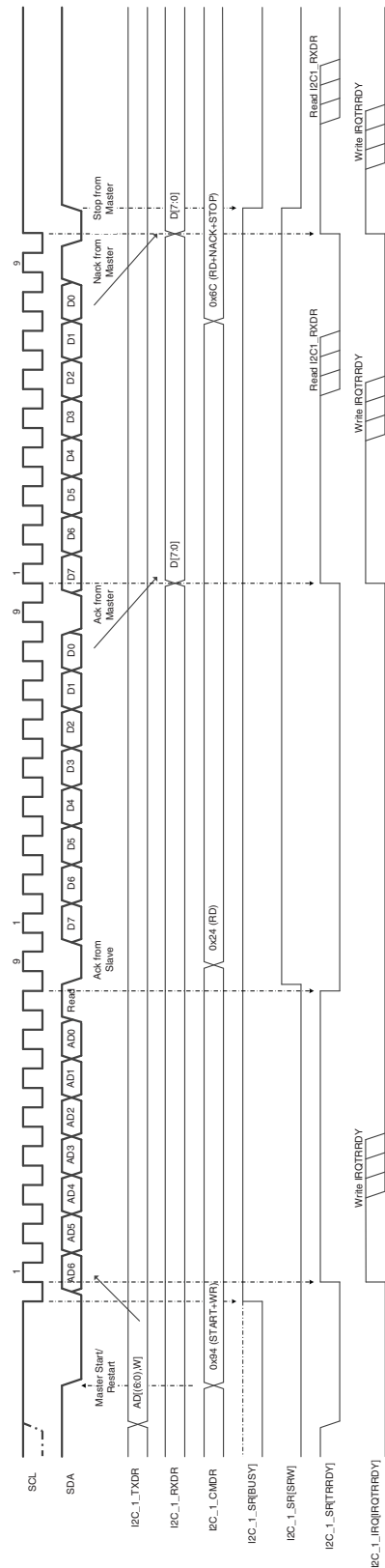

Figure 17-13. EFB Slave – I²C Write

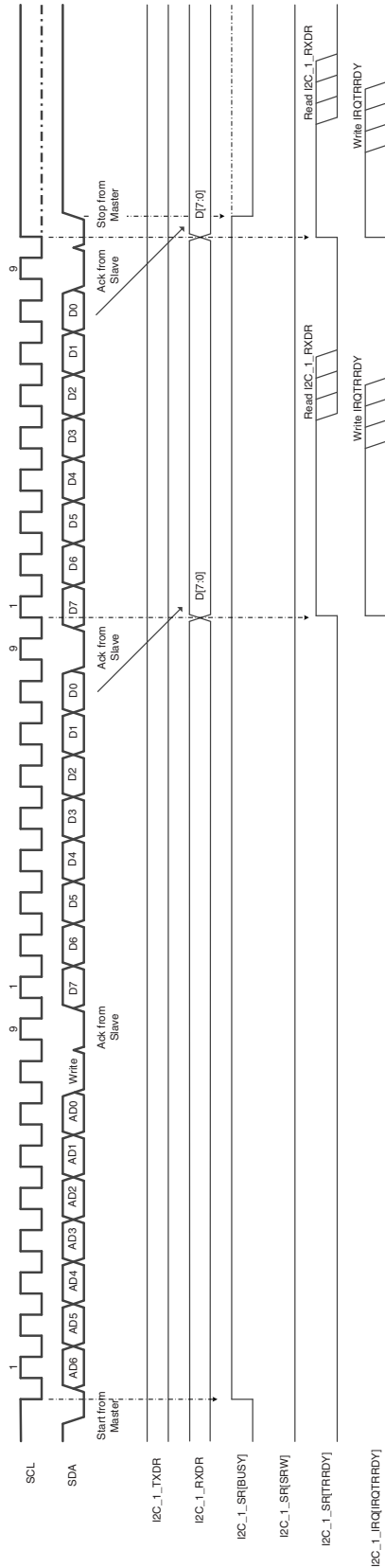
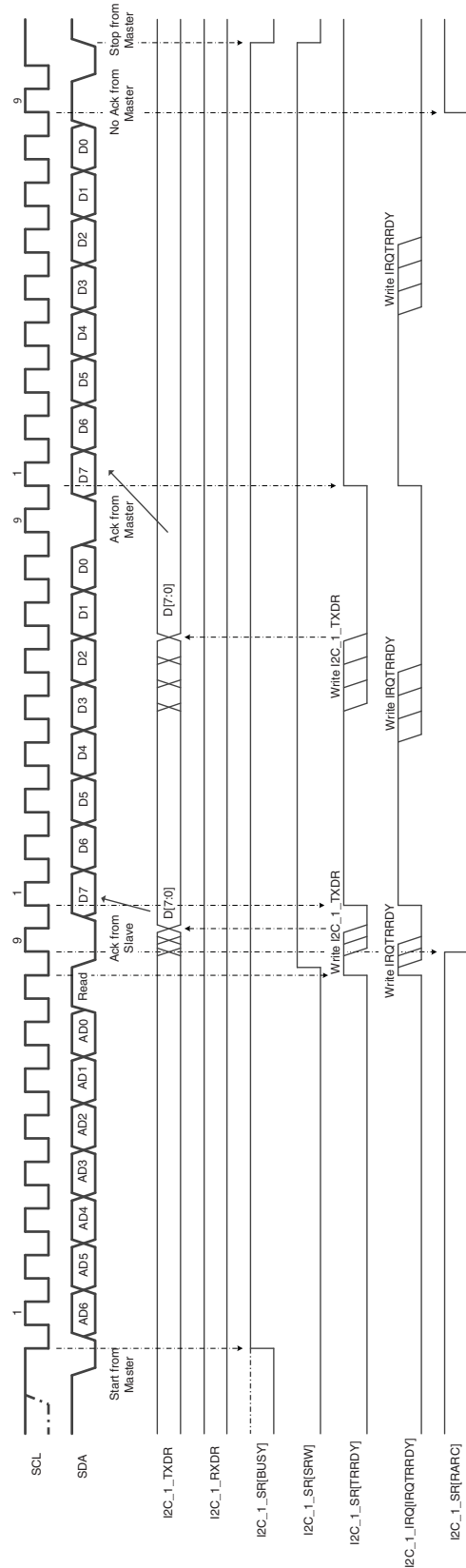
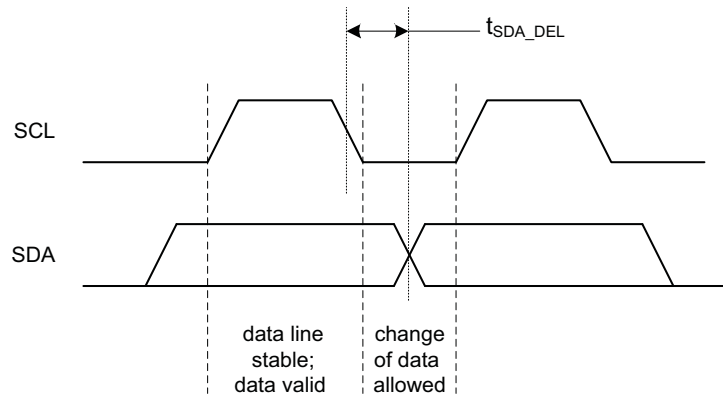

Figure 17-14. EFB Slave – I²C Read



I²C Timing Diagram

Figure 17-15. I²C Bit Transfer Timing



I²C Simulation Model

The I²C EFB Register Map translation to the MachXO2 EFB software simulation model is provided in below.

Table 17-14. I²C Primary Simulation Mode

I ² C Primary Register Name	Register Size/Bit Location	Register Function	Address I ² C Primary	Access	Simulation Model Register Name	Simulation Model Register Path
I2C_1_CR	[7:0]	Control	0x40	Read/Write	i2ccr1[7:0]	../efb_top/config_plus_inst/config_core_inst/cfg_cdu/njport_unit/i2c_1st/
I2CEN	7				i2c_en	../efb_top/config_plus_inst/config_core_inst/cfg_cdu/njport_unit/i2c_1st/
GCEN	6				i2c_gcen	../efb_top/config_plus_inst/config_core_inst/cfg_cdu/njport_unit/i2c_1st/
WKUPEN	5				i2c_wkupen	../efb_top/config_plus_inst/config_core_inst/cfg_cdu/njport_unit/i2c_1st/
SDA_DEL_SEL[1:0]	[3:2]				sda_del_sel	../efb_top/config_plus_inst/config_core_inst/cfg_cdu/njport_unit/i2c_1st/
I2C_1_CMDR	[7:0]	Command	0x41	Read/Write	i2ccmdr[7:0]	../efb_top/config_plus_inst/config_core_inst/cfg_cdu/njport_unit/i2c_1st/
STA	7				i2c_sta	../efb_top/config_plus_inst/config_core_inst/cfg_cdu/njport_unit/i2c_1st/
STO	6				i2c_sto	../efb_top/config_plus_inst/config_core_inst/cfg_cdu/njport_unit/i2c_1st/
RD	5				i2c_rd	../efb_top/config_plus_inst/config_core_inst/cfg_cdu/njport_unit/i2c_1st/
WR	4				i2c_wt	../efb_top/config_plus_inst/config_core_inst/cfg_cdu/njport_unit/i2c_1st/
ACK	3				i2c_nack	../efb_top/config_plus_inst/config_core_inst/cfg_cdu/njport_unit/i2c_1st/
CKSDIS	2				i2c_cksdis	../efb_top/config_plus_inst/config_core_inst/cfg_cdu/njport_unit/i2c_1st/
I2C_1_BR0	[7:0]	Clock Pre-scale	0x42	Read/Write	i2cbr[7:0]	../efb_top/config_plus_inst/config_core_inst/cfg_cdu/njport_unit/i2c_1st/
I2C_PRESCALE[7:0]	[7:0]				i2cbr[7:0]	../efb_top/config_plus_inst/config_core_inst/cfg_cdu/njport_unit/i2c_1st/
I2C_1_BR1	[7:0]	Clock Pre-scale	0x43	Read/Write	i2cbr[9:8]	../efb_top/config_plus_inst/config_core_inst/cfg_cdu/njport_unit/i2c_1st/
I2C_PRESCALE[9:8]	[1:0]				i2cbr[9:8]	../efb_top/config_plus_inst/config_core_inst/cfg_cdu/njport_unit/i2c_1st/
I2C_1_TXDR	[7:0]	Transmit Data	0x44	Write	i2ctxdr[7:0]	../efb_top/config_plus_inst/config_core_inst/cfg_cdu/njport_unit/i2c_1st/
I2C_Transmit_Data[7:0]	[7:0]				i2ctxdr[7:0]	../efb_top/config_plus_inst/config_core_inst/cfg_cdu/njport_unit/i2c_1st/
I2C_1_SR	[7:0]	Status	0x45	Read	i2csr[7:0]	../efb_top/config_plus_inst/config_core_inst/cfg_cdu/njport_unit/i2c_1st/

Table 17-14. I²C Primary Simulation Mode (Continued)

I ² C Primary Register Name	Register Size/Bit Location	Register Function	Address I ² C Primary	Access	Simulation Model Register Name	Simulation Model Register Path
TIP	7				i2c_tip_sync	../efb_top/config_plus_inst/config_core_inst/cfg_cdu/njport_unit/i2c_1st/
BUSY	6				i2c_busy_sync	../efb_top/config_plus_inst/config_core_inst/cfg_cdu/njport_unit/i2c_1st/
RARC	5				i2c_rarc_sync	../efb_top/config_plus_inst/config_core_inst/cfg_cdu/njport_unit/i2c_1st/
SRW	4				i2c_srw_sync	../efb_top/config_plus_inst/config_core_inst/cfg_cdu/njport_unit/i2c_1st/
ARBL	3				i2c_arbl	../efb_top/config_plus_inst/config_core_inst/cfg_cdu/njport_unit/i2c_1st/
TRRDY	2				i2c_trrdy	../efb_top/config_plus_inst/config_core_inst/cfg_cdu/njport_unit/i2c_1st/
TROE	1				i2c_troe	../efb_top/config_plus_inst/config_core_inst/cfg_cdu/njport_unit/i2c_1st/
HGC	0				i2c_hgc	../efb_top/config_plus_inst/config_core_inst/cfg_cdu/njport_unit/i2c_1st/
I2C_1_GCDR	[7:0]	General Call	0x46	Read	i2cgcdr[7:0]	../efb_top/config_plus_inst/config_core_inst/cfg_cdu/njport_unit/i2c_1st/
I2C_GC_Data[7:0]	[7:0]				i2cgcdr[7:0]	../efb_top/config_plus_inst/config_core_inst/cfg_cdu/njport_unit/i2c_1st/
I2C_1_RXDR	[7:0]	Receive Data	0x47	Read	i2cxdcr[7:0]	../efb_top/config_plus_inst/config_core_inst/cfg_cdu/njport_unit/i2c_1st/
I2C_Receive_Data[7:0]	[7:0]				i2cxdcr[7:0]	../efb_top/config_plus_inst/config_core_inst/cfg_cdu/njport_unit/i2c_1st/
I2C_1_IRQ	[7:0]	IRQ	0x48	Read/Write	{1'b0, 1'b0, 1'b0, 1'b0, i2csr_1st_irqsts_3, i2csr_1st_irqsts_2, i2csr_1st_irqsts_1, i2csr_1st_irqsts_0}	../efb_top/efb_pll_sci_inst/u_efb_sci/
IRQARBL	3				i2csr_1st_irqsts_3	../efb_top/efb_pll_sci_inst/u_efb_sci/
IRQTRRDY	2				i2csr_1st_irqsts_2	../efb_top/efb_pll_sci_inst/u_efb_sci/
IRQTROE	1				i2csr_1st_irqsts_1	../efb_top/efb_pll_sci_inst/u_efb_sci/
IRQHGC	0				i2csr_1st_irqsts_0	../efb_top/efb_pll_sci_inst/u_efb_sci/
I2C_1_IRQEN	[7:0]	IRQ Enable	0x49	Read/Write	{1'b0, 1'b0, 1'b0, 1'b0, i2csr_1st_irqena_3, i2csr_1st_irqena_2, i2csr_1st_irqena_1, i2csr_1st_irqena_0}	../efb_top/efb_pll_sci_inst/u_efb_sci/
IRQARBLN	3				i2csr_1st_irqena_3	../efb_top/efb_pll_sci_inst/u_efb_sci/
IRQTRRDYEN	2				i2csr_1st_irqena_2	../efb_top/efb_pll_sci_inst/u_efb_sci/
IRQTROEEN	1				i2csr_1st_irqena_1	../efb_top/efb_pll_sci_inst/u_efb_sci/
IRQHGCEN	0				i2csr_1st_irqena_0	../efb_top/efb_pll_sci_inst/u_efb_sci/

Table 17-15. I²C Secondary Simulation Model

I ² C Secondary Register Name	Register Size/Bit Location	Register Function	Address I ² C Secondary	Access	Simulation Model Register Name	Simulation Model Register Path
I2C_2_CR	[7:0]	Control	0x4A	Read/Write	i2ccr1[7:0]	../efb_top/config_plus_inst/config_core_inst/cfg_cdu/njport_unit/i2c_2nd/
I2CEN	7				i2c_en	../efb_top/config_plus_inst/config_core_inst/cfg_cdu/njport_unit/i2c_2nd/
GCEN	6				i2c_gcen	../efb_top/config_plus_inst/config_core_inst/cfg_cdu/njport_unit/i2c_2nd/
WKUPEN	5				i2c_wkupen	../efb_top/config_plus_inst/config_core_inst/cfg_cdu/njport_unit/i2c_2nd/
SDA_DEL_SEL[1:0]	[3:2]				sda_del_sel	../efb_top/config_plus_inst/config_core_inst/cfg_cdu/njport_unit/i2c_2nd/
I2C_2_CMDR	[7:0]	Command	0x4B	Read/Write	i2ccmdr[7:0]	../efb_top/config_plus_inst/config_core_inst/cfg_cdu/njport_unit/i2c_2nd/
STA	7				i2c_sta	../efb_top/config_plus_inst/config_core_inst/cfg_cdu/njport_unit/i2c_2nd/
STO	6				i2c_sto	../efb_top/config_plus_inst/config_core_inst/cfg_cdu/njport_unit/i2c_2nd/
RD	5				i2c_rd	../efb_top/config_plus_inst/config_core_inst/cfg_cdu/njport_unit/i2c_2nd/
WR	4				i2c_wt	../efb_top/config_plus_inst/config_core_inst/cfg_cdu/njport_unit/i2c_2nd/
ACK	3				i2c_nack	../efb_top/config_plus_inst/config_core_inst/cfg_cdu/njport_unit/i2c_2nd/
CKSDIS	2				i2c_cksdis	../efb_top/config_plus_inst/config_core_inst/cfg_cdu/njport_unit/i2c_2nd/
I2C_2_BR0	[7:0]	Clock Pre-scale	0x4C	Read/Write	i2cbr[7:0]	../efb_top/config_plus_inst/config_core_inst/cfg_cdu/njport_unit/i2c_2nd/
I2C_PRESCALE[7:0]	[7:0]				i2cbr[7:0]	../efb_top/config_plus_inst/config_core_inst/cfg_cdu/njport_unit/i2c_2nd/
I2C_2_BR1	[7:0]	Clock Pre-scale	0x4D	Read/Write	i2cbr[9:8]	../efb_top/config_plus_inst/config_core_inst/cfg_cdu/njport_unit/i2c_2nd/
I2C_PRESCALE[9:8]	[1:0]				i2cbr[9:8]	../efb_top/config_plus_inst/config_core_inst/cfg_cdu/njport_unit/i2c_2nd/
I2C_2_TXDR	[7:0]	Transmit Data	0x4E	Write	i2ctxdr[7:0]	../efb_top/config_plus_inst/config_core_inst/cfg_cdu/njport_unit/i2c_2nd/
I2C_Transmit_Data[7:0]	[7:0]				i2ctxdr[7:0]	../efb_top/config_plus_inst/config_core_inst/cfg_cdu/njport_unit/i2c_2nd/
I2C_2_SR	[7:0]	Status	0x4F	Read	i2csr[7:0]	../efb_top/config_plus_inst/config_core_inst/cfg_cdu/njport_unit/i2c_2nd/
TIP	7				i2c_tip_sync	../efb_top/config_plus_inst/config_core_inst/cfg_cdu/njport_unit/i2c_2nd/
BUSY	6				i2c_busy_sync	../efb_top/config_plus_inst/config_core_inst/cfg_cdu/njport_unit/i2c_2nd/
RARC	5				i2c_rarc_sync	../efb_top/config_plus_inst/config_core_inst/cfg_cdu/njport_unit/i2c_2nd/
SRW	4				i2c_srw_sync	../efb_top/config_plus_inst/config_core_inst/cfg_cdu/njport_unit/i2c_2nd/
ARBL	3				i2c_arbl	../efb_top/config_plus_inst/config_core_inst/cfg_cdu/njport_unit/i2c_2nd/
TRRDY	2				i2c_trrdy	../efb_top/config_plus_inst/config_core_inst/cfg_cdu/njport_unit/i2c_2nd/
TROE	1				i2c_troe	../efb_top/config_plus_inst/config_core_inst/cfg_cdu/njport_unit/i2c_2nd/
HGC	0				i2c_hgc	../efb_top/config_plus_inst/config_core_inst/cfg_cdu/njport_unit/i2c_2nd/
I2C_2_GCDR	[7:0]	General Call	0x50	Read	i2cgcdr[7:0]	../efb_top/config_plus_inst/config_core_inst/cfg_cdu/njport_unit/i2c_2nd/
I2C_GC_Data[7:0]	[7:0]				i2cgcdr[7:0]	../efb_top/config_plus_inst/config_core_inst/cfg_cdu/njport_unit/i2c_2nd/
I2C_2_RXDR	[7:0]	Receive Data	0x51	Read	i2crxdr[7:0]	../efb_top/config_plus_inst/config_core_inst/cfg_cdu/njport_unit/i2c_2nd/
I2C_Receive_Data[7:0]	[7:0]				i2crxdr[7:0]	../efb_top/config_plus_inst/config_core_inst/cfg_cdu/njport_unit/i2c_2nd/

Table 17-15. I²C Secondary Simulation Model (Continued)

I ² C Secondary Register Name	Register Size/Bit Location	Register Function	Address I ² C Secondary	Access	Simulation Model Register Name	Simulation Model Register Path
I2C_2_IRQ	[7:0]	IRQ	0x52	Read/Write	{1'b0, 1'b0, 1'b0, 1'b0, i2csr_2nd_irqsts_3, i2csr_2nd_irqsts_2, i2csr_2nd_irqsts_1, i2csr_2nd_irqsts_0}	../efb_top/efb_pll_sci_inst/u_efb_sci/
IRQARBL	3				i2csr_2nd_irqsts_3	../efb_top/efb_pll_sci_inst/u_efb_sci/
IRQTRRDY	2				i2csr_2nd_irqsts_2	../efb_top/efb_pll_sci_inst/u_efb_sci/
IRQTROE	1				i2csr_2nd_irqsts_1	../efb_top/efb_pll_sci_inst/u_efb_sci/
IRQHGC	0				i2csr_2nd_irqsts_0	../efb_top/efb_pll_sci_inst/u_efb_sci/
I2C_2_IRQEN	[7:0]	IRQ Enable	0x53	Read/Write	{1'b0, 1'b0, 1'b0, 1'b0, i2csr_2nd_irqena_3, i2csr_2nd_irqena_2, i2csr_2nd_irqena_1, i2csr_2nd_irqena_0}	../efb_top/efb_pll_sci_inst/u_efb_sci/
IRQARBLN	3				i2csr_2nd_irqena_3	../efb_top/efb_pll_sci_inst/u_efb_sci/
IRQTRRDYEN	2				i2csr_2nd_irqena_2	../efb_top/efb_pll_sci_inst/u_efb_sci/
IRQTROEEN	1				i2csr_2nd_irqena_1	../efb_top/efb_pll_sci_inst/u_efb_sci/
IRQHGCEN	0				i2csr_2nd_irqena_0	../efb_top/efb_pll_sci_inst/u_efb_sci/

Hardened SPI IP Core

The MachXO2 EFB contains a hard SPI IP core that can be configured as a SPI Master or Slave. When the SPI core is configured as a Master it is able to control other devices with Slave SPI interfaces that are connected to the SPI bus. When the SPI core is configured as a Slave, it is able to interface to an external SPI Master device.

SPI Registers

The SPI core communicates with the WISHBONE interface through a set of control, command, status and data registers. Table 17-16 shows the register names and their functions. These registers are a subset of the EFB register map.

Table 17-16. SPI Registers

SPI Register Name	Register Function	Address	Access
SPICR0	Control Register 0	0x54	Read/Write
SPICR1	Control Register 1	0x55	Read/Write
SPICR2	Control Register 2	0x56	Read/Write
SPIBR	Clock Pre-scale	0x57	Read/Write
SPICSR	Master Chip Select	0x58	Read/Write
SPITXDR	Transmit Data	0x59	Write
SPIR	Status	0x5A	Read
SPIRXDR	Receive Data	0x5B	Read
SPIIRQ	Interrupt Request	0x5C	Read/Write
SPIIRQEN	Interrupt Request Enable	0x5D	Read/Write

Note: Unless otherwise specified, all Reserved bits in writable registers shall be written '0'.

Table 17-17. SPI Control 0

SPICR0								0x54
Bit	7	6	5	4	3	2	1	0
Name	TIdle_XCNT[1:0]		TTrail_XCNT[2:0]			TLead_XCNT[2:0]		
Default	0	0	0	0	0	0	0	0
Access	R/W	R/W	R/W	R/W	R/W	R/W	R/W	R/W

Note: A write to this register will cause the SPI core to reset.

- TIdle_XCNT[1:0]** Idle Delay Count. Specifies the minimum interval prior to the Master Chip Select low assertion (Master Mode only), in SCK periods.
- 00: ½
 - 01: 1
 - 10: 1.5
 - 11: 2
- TTrail_XCNT[2:0]** Trail Delay Count. Specifies the minimum interval between the last edge of SCK and the high deassertion of Master Chip Select (Master Mode only), in SCK periods.
- 000: ½
 - 001: 1
 - 010: 1.5
 - ...
 - 111: 4
- TLead_XCNT[2:0]** Lead Delay Count. Specifies the minimum interval between the Master Chip Select low assertion and the first edge of SCK (Master Mode only), in SCK periods.
- 000: ½
 - 001: 1
 - 010: 1.5
 - ...
 - 111: 4

Table 17-18. SPI Control 1

SPICR1								0x55
Bit	7	6	5	4	3	2	1	0
Name	SPE	WKUPEN_USER	WKUPEN_CFG	TXEDGE	(Reserved)			
Default	0	0	0	0	0	0	0	0
Access	R/W	R/W	R/W	R/W	—	—	—	—

Note: A write to this register will cause the SPI core to reset.

- SPE** This bit enables the SPI core functions. If SPE is cleared, SPI is disabled and forced into idle state.
- 0: SPI disabled
 - 1: SPI enabled, port pins are dedicated to SPI functions.
- WKUPEN_USER** Wake-up Enable via User. Enables the SPI core to send a wake-up signal to the on-chip Power Controller to wake the part from Standby mode when the User slave SPI chip select (spi_scsn) is driven low.
- 0: Wakeup disabled
 - 1: Wakeup enabled.

WKUPEN_CFG Wake-up Enable Configuration. Enables the SPI core to send a wake-up signal to the on-chip power controller to wake the part from standby mode when the Configuration slave SPI chip select (ufm_sn) is driven low.

- 0: Wakeup disabled
- 1: Wakeup enabled.

TXEDGE Data Transmit Edge. Enables Lattice proprietary extension to the SPI protocol. Selects which clock edge to transmit SPI data. Refer to Figures 17-29 through 17-31.

- 0: Transmit data on the MCLK edge defined by SPICR2[CPOL] and SPICR2[CPHA]
- 1: Transmit data $\frac{1}{2}$ MCLK earlier than defined by SPICR2[CPOL] and SPICR2[CPHA]

Table 17-19. SPI Control 2

SPICR2								0x56
Bit	7	6	5	4	3	2	1	0
Name	MSTR	MCSH	SDBRE	(Reserved)	(Reserved)	CPOL	CPHA	LSBF
Default	0	0	0	0	0	0	0	0
Access	R/W	R/W	R/W	—	—	R/W	R/W	R/W

Note: A write to this register will cause the SPI core to reset.

MSTR SPI Master/Slave Mode. Selects the Master/Slave operation mode of the SPI core. Changing this bit forces the SPI system into idle state.

- 0: SPI is in Slave mode
- 1: SPI is in Master mode

MCSH SPI Master CSSPIN Hold. Holds the Master chip select active when the host is busy, to halt the data transmission without de-asserting chip select.

Note: This mode must be used only when the WISHBONE clock has been divided by a value greater than four (4) (greater than six (6) for R1 devices). For more details on the R1 to Standard migration refer to AN8086, [Designing for Migration from MachXO2-1200-R1 to Standard \(Non-R1\) Devices](#).

- 0: Master running as normal
- 1: Master holds chip select low even if there is no data to be transmitted

SDBRE Slave Dummy Byte Response Enable. Enables Lattice proprietary extension to the SPI protocol. For use when the internal support circuit (e.g. WISHBONE host) cannot respond with initial data within the time required, and to make the slave read out data predictably available at high SPI clock rates.

When enabled, dummy 0xFF bytes will be transmitted in response to a SPI slave read (while SPISR[TRDY]=1) until an initial write to SPITXDR. Once a byte is written into SPITXDR by the WISHBONE host, a single byte of 0x00 will be transmitted then followed immediately by the data in SPITXDR. In this mode, the external SPI master should scan for the initial 0x00 byte when reading the SPI slave to indicate the beginning of actual data. Refer to Figure 17-23.

- 0: Normal Slave SPI operation
- 1: Lattice proprietary Slave Dummy Byte Response Enabled

Note: This mechanism only applies for the initial data delay period. Once the initial data is available, subsequent data must be supplied to SPITXDR at the required SPI bus data rate.

- CPOL** SPI Clock Polarity. Selects an inverted or non-inverted SPI clock. To transmit data between SPI modules, the SPI modules must have identical SPICR2[CPOL] values. In master mode, a change of this bit will abort a transmission in progress and force the SPI system into idle state. Refer to Figures 17-29 through 17-31.
- 0: Active-high clocks selected. In idle state SCK is high.
 - 1: Active-low clocks selected. In idle state SCK is low.
- CPHA** SPI Clock Phase. Selects the SPI clock format. In master mode, a change of this bit will abort a transmission in progress and force the SPI system into idle state. Refer to Refer to Figures 17-29 through 17-31.
- 0: Data is captured on a leading (first) clock edge, and propagated on the opposite clock edge.
 - 1: Data is captured on a trailing (second) clock edge, and propagated on the opposite clock edge*.
- Note: When CPHA=1, the user must explicitly place a pull-up or pull-down on SCK pad corresponding to the value of CPOL (e.g. when CPHA=1 and CPOL=0 place a pull-down on SCK). When CPHA=0, the pull direction may be set arbitrarily.*
- Slave SPI Configuration mode supports default setting only for CPOL, CPHA.
- LSBF** LSB-First. LSB appears first on the SPI interface. In master mode, a change of this bit will abort a transmission in progress and force the SPI system into idle state. Refer to Figures 17-29 through 17-31.
- Note: This bit does not affect the position of the MSB and LSB in the data register. Reads and writes of the data register always have the MSB in bit 7.*
- 0: Data is transferred most significant bit (MSB) first
 - 1: Data is transferred least significant bit (LSB) first

Table 17-20. SPI Clock Prescale

SPIBR								0x57
Bit	7	6	5	4	3	2	1	0
Name	(Reserved)		DIVIDER[5:0]					
Default ¹	0	0	0	0	0	0	0	0
Access	—	—	R/W	R/W	R/W	R/W	R/W	R/W

1. Hardware default value may be overridden by EFB component instantiation parameters. See discussion below.

- DIVIDER[5:0]** SPI Clock Prescale value. The WISHBONE clock frequency is divided by (DIVIDER[5:0] + 1) to produce the desired SPI clock frequency. A write operation to this register will cause a SPI core reset. DIVIDER must be ≥ 1 .
- Note: The digital value is calculated by IPexpress when the SPI core is configured in the SPI tab of the EFB GUI. The calculation is based on the WISHBONE Clock Frequency and the SPI Frequency, both entered by the user. The digital value of the divider is programmed in the MachXO2 device during device programming. After power-up or device reconfiguration, the data is loaded onto the SPIBR register.*
- Register SPIBR has Read/Write access from the WISHBONE interface. Designers can update the clock pre-scale register dynamically during device operation.

Table 17-21. SPI Master Chip Select

SPICSR								0x58
Bit	7	6	5	4	3	2	1	0
Name	CSN_7	CSN_6	CSN_5	CSN_4	CSN_3	CSN_2	CSN_1	CSN_0
Default	0	0	0	0	0	0	0	0
Access	R/W	R/W	R/W	R/W	R/W	R/W	R/W	R/W

CSN_[7:0] SPI Master Chip Selects. Used in master mode for asserting a specific Master Chip Select (MCSN) line. The register has eight bits, enabling the SPI core to control up to eight external SPI slave devices. Each bit represents one master chip select line (Active-Low). Bits [7:1] may be connected to any I/O pin via the FPGA fabric. Bit 0 has a pre-assigned pin location. The register has Read/Write access from the WISHBONE interface. A write operation on this register will cause the SPI core to reset.

Table 17-22. SPI Transmit Data Register

SPITXDR								0x59
Bit	7	6	5	4	3	2	1	0
Name	SPI_Transmit_Data[7:0]							
Default	—	—	—	—	—	—	—	—
Access	W	W	W	W	W	W	W	W

SPI_Transmit_Data[7:0] SPI Transmit Data. This register holds the byte that will be transmitted on the SPI bus. Bit 0 in this register is LSB, and will be transmitted last when SPICR2[LSBF]=0 or first when SPICR2[LSBF]=1.

Note: When operating as a Slave, SPITXDR must be written when SPISR[TRDY] is '1' and at least 0.5 CCLKs before the first bit is to appear on SO. For example, when CPOL = CPHA = TXEDGE = LSBF = 0, SPITXDR must be written prior to the CCLK rising edge used to sample the LSB (bit 0) of the previous byte. See Figure 17-29. This timing requires at least one protocol dummy byte be included for all slave SPI read operations.

Table 17-23. SPI Status

SPISR								0x5A
Bit	7	6	5	4	3	2	1	0
Name	TIP	(Reserved)		TRDY	RRDY	(Reserved)	ROE	MDF
Default	0	—	—	0	0	—	0	0
Access	R	—	—	R	R	—	R	R

TIP SPI Transmitting In Progress. Indicates the SPI port is actively transmitting/receiving data.
 0: SPI Transmitting complete
 1: SPI Transmitting in progress*

Note: This bit is non-functional in R1 devices. For more details on the R1 to Standard migration refer to AN8086, [Designing for Migration from MachXO2-1200-R1 to Standard \(Non-R1\) Devices](#).

TRDY SPI Transmit Ready. Indicates the SPI transmit data register (SPITXDR) is empty. This bit is cleared by a write to SPITXDR. This bit is capable of generating an interrupt.
 0: SPITXDR is not empty
 1: SPITXDR is empty

- RRDY** SPI Receive Ready. Indicates the receive data register (SPIRXDR) contains valid receive data. This bit is cleared by a read access to SPIRXDR. This bit is capable of generating an interrupt.
 0: SPIRXDR does not contain data
 1: SPIRXDR contains valid receive data
- ROE** Receive Overrun Error. Indicates SPIRXDR received new data before the previous data was read. The previous data is lost. This bit is capable of generating an interrupt.
 0: Normal
 1: Receiver Overrun detected
- MDF** Mode Fault. Indicates the Slave SPI chip select (spi_scsn) was driven low while SPICR2[MSTR]=1. This bit is cleared by any write to SPICR0, SPICR1 or SPICR2. This bit is capable of generating an interrupt.
 0: Normal
 1: Mode Fault detected

Table 17-24. SPI Receive Data Register

SPIRXDR								0x5B
Bit	7	6	5	4	3	2	1	0
Name	SPI_Receive_Data[7:0]							
Default	0	0	0	0	0	0	0	0
Access	R	R	R	R	R	R	R	R

SPI_Receive_Data[7:0] SPI Receive Data. This register holds the byte captured from the SPI bus. Bit 0 in this register is LSB and was received last when LSBF=0 or first when LSBF=1.

Table 17-25. SPI Interrupt Status

SPIIRQ								0x5C
Bit	7	6	5	4	3	2	1	0
Name	(Reserved)			IRQTRDY	IRQRRDY	(Reserved)	IRQROE	IRQMDF
Default	—	—	—	0	0	—	0	0
Access	—	—	—	R/W	R/W	—	R/W	R/W

- IRQTRDY** Interrupt Status for SPI Transmit Ready. When enabled, indicates SPISR[TRDY] was asserted. Write a '1' to this bit to clear the interrupt.
 1: SPI Transmit Ready Interrupt
 0: No interrupt
- IRQRRDY** Interrupt Status for SPI Receive Ready. When enabled, indicates SPISR[RRDY] was asserted. Write a '1' to this bit to clear the interrupt.
 1: SPI Receive Ready Interrupt
 0: No interrupt
- IRQROE** Interrupt Status for Receive Overrun Error. When enabled, indicates ROE was asserted. Write a '1' to this bit to clear the interrupt.
 1: Receive Overrun Error Interrupt
 0: No interrupt

IRQMDF Interrupt Status for Mode Fault.
 When enabled, indicates MDF was asserted. Write a '1' to this bit to clear the interrupt.
 1: Mode Fault Interrupt
 0: No interrupt

Table 17-26. SPI Interrupt Enable

SPIIRQEN								0x5D
Bit	7	6	5	4	3	2	1	0
Name	(Reserved)			IRQTRDYEN	IRQRRDYEN	(Reserved)	IRQROEEN	IRQMDFEN
Default	0	0	0	0	0	0	0	0
Access	—	—	—	R/W	R/W	—	R/W	R/W

IRQTRDYEN Interrupt Enable for SPI Transmit Ready.
 1: Interrupt generation enabled
 0: Interrupt generation disabled

IRQRRDYEN Interrupt Enable for SPI Receive Ready
 1: Interrupt generation enabled
 0: Interrupt generation disabled

IRQROEEN Interrupt Enable for Receive Overrun Error
 1: Interrupt generation enabled
 0: Interrupt generation disabled

IRQMDFEN Interrupt Enable for Mode Fault
 1: Interrupt generation enabled
 0: Interrupt generation disabled

Figure 17-16 shows a flow diagram for controlling Master SPI reads and writes initiated via the WISHBONE interface.

Figure 17-16. SPI Master Read/Write Example (via WISHBONE) – Production Silicon

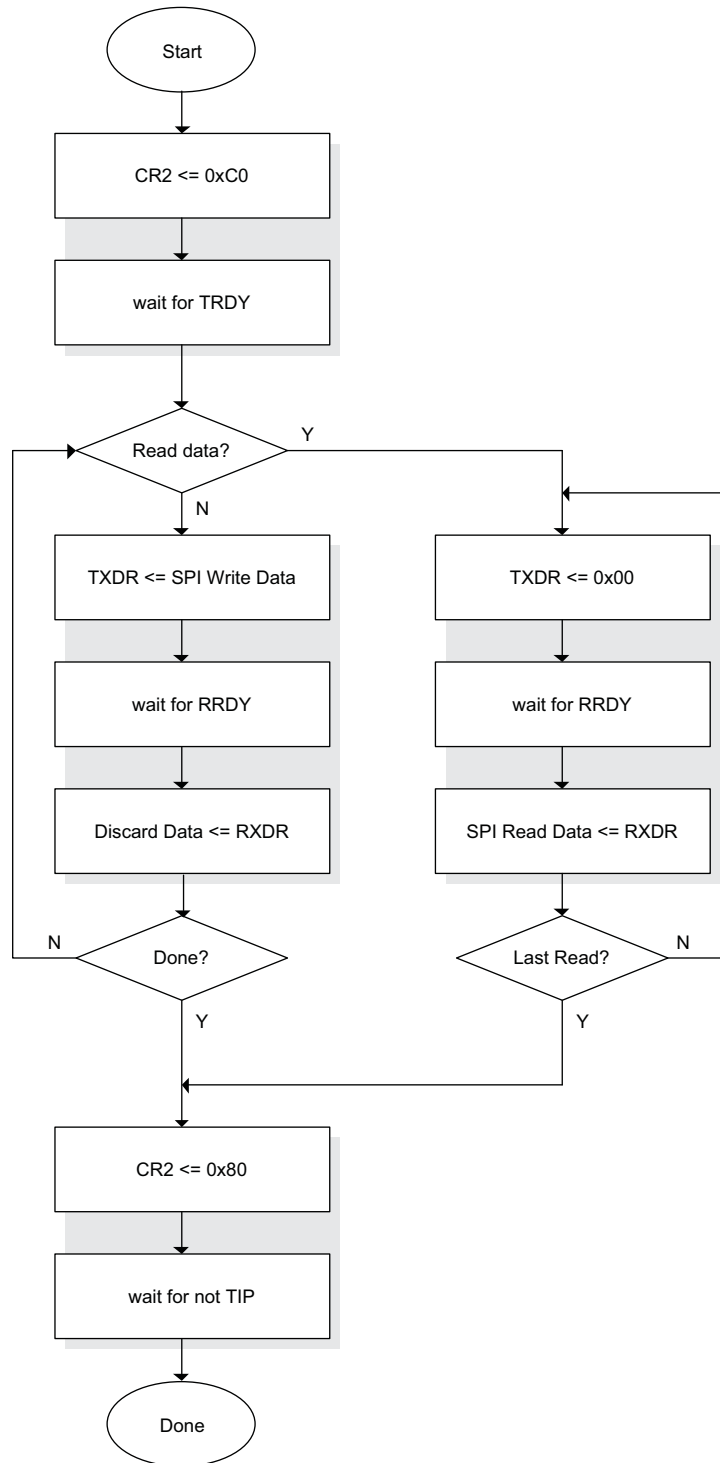

Note: Assumes CR2 register, MSCH = '1'. The algorithm when MSCH = '0' is application dependent and not provided. See Figure 17-22 for guidance.

Figure 17-17. SPI Master Read/Write Example (via WISHBONE) – R1 Silicon

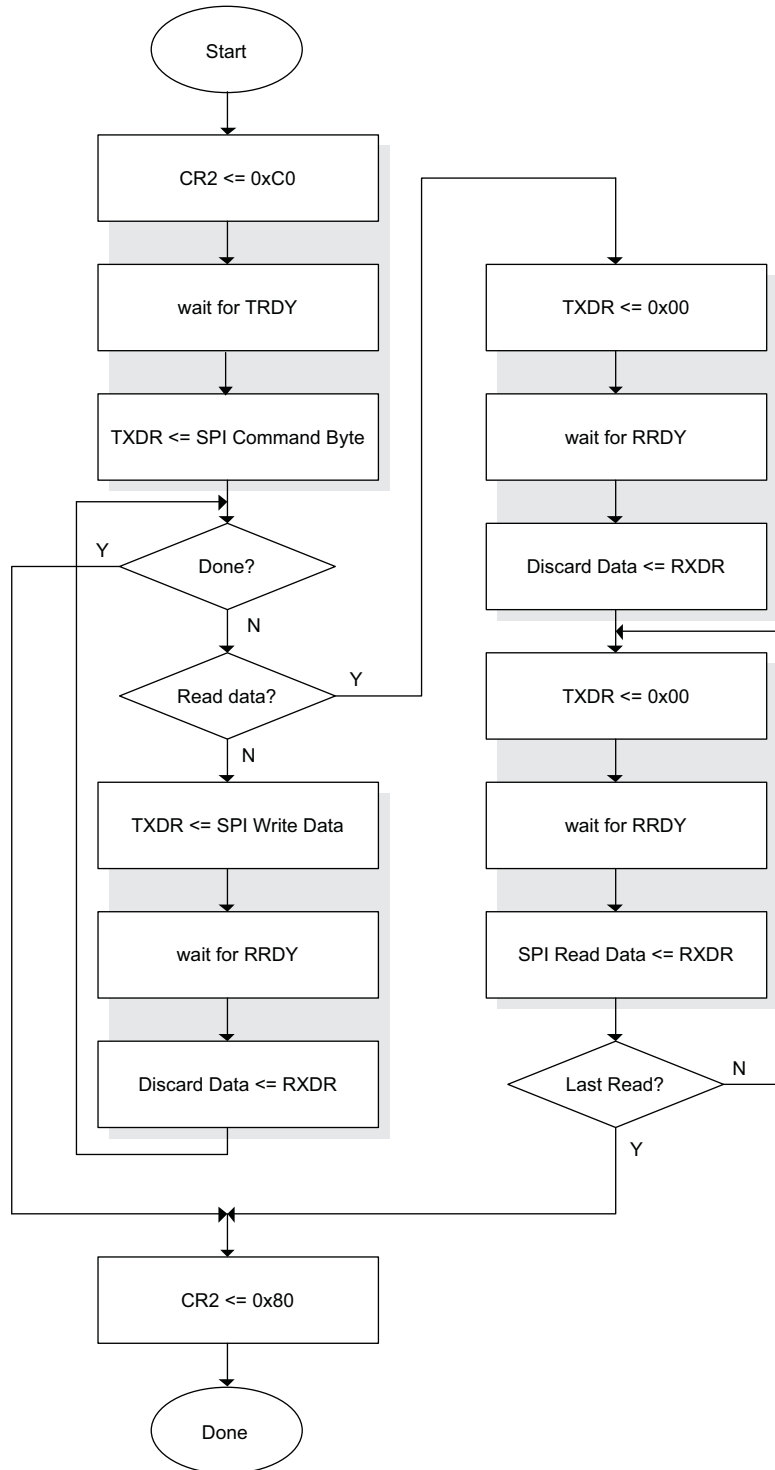

Note: For more details on the R1 to Standard migration refer to AN8086, [Designing for Migration from MachXO2-1200-R1 to Standard \(Non-R1\) Devices](#).

Figure 17-18. SPI Slave Read/Write Example (via WISHBONE) - Production Silicon

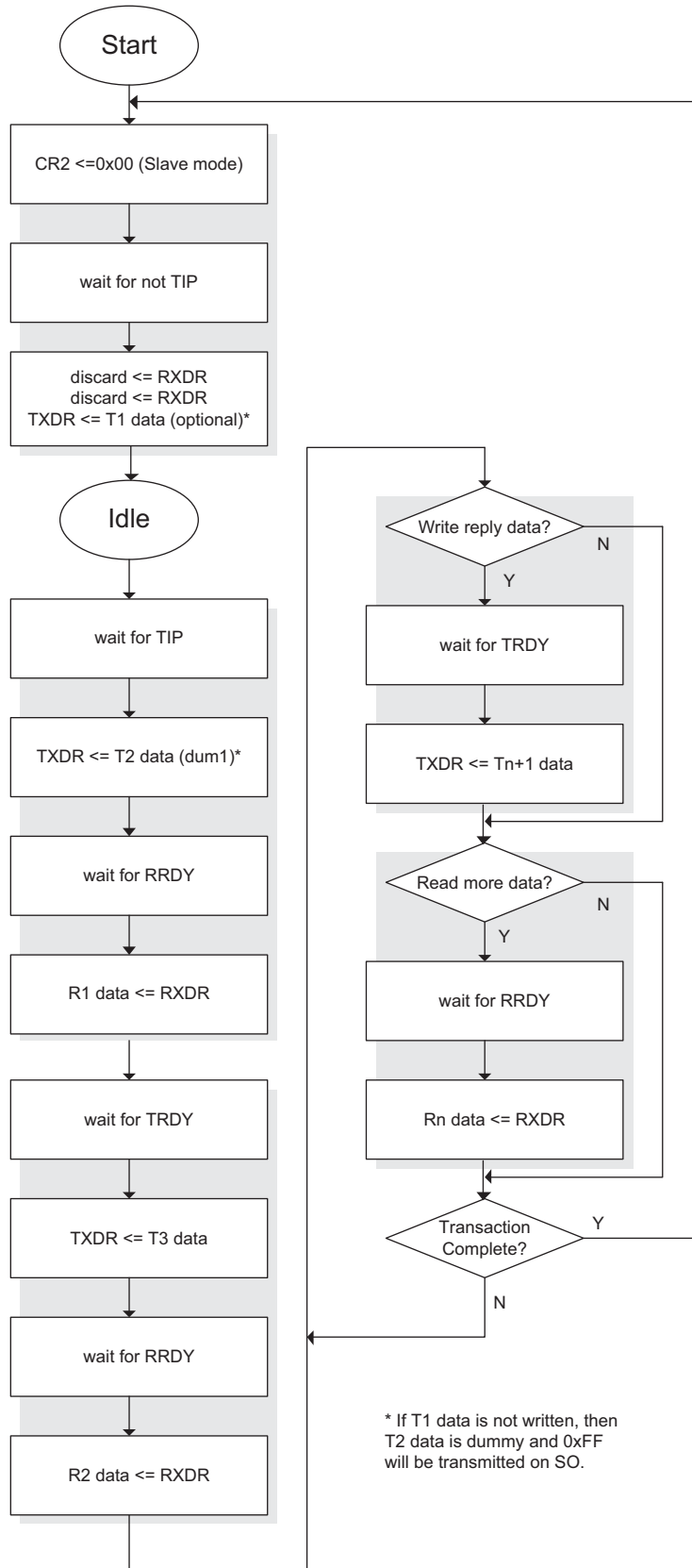

Typical SPI Transactions

Figures 17-19, 17-20, and 17-21 illustrate typical User SPI bus protocol transactions that are supported by the Master and Slave flows shown in Figures 17-16, 17-17, and 17-18. Additionally, the figures below reference typical sysConfig Configuration commands structures.

Figure 17-19. Simple SPI Command (e.g. ISC_ERASE)

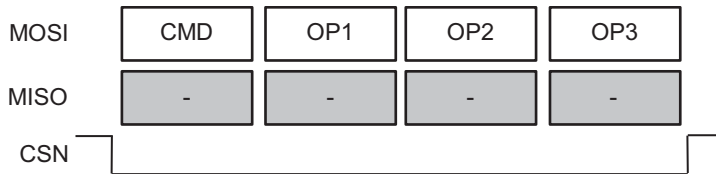

Figure 17-20. SPI Command w/ Write Data (e.g. LSC_PROG_INCR_NV)

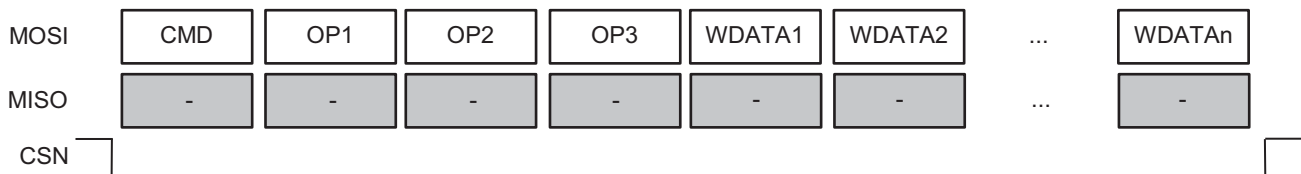
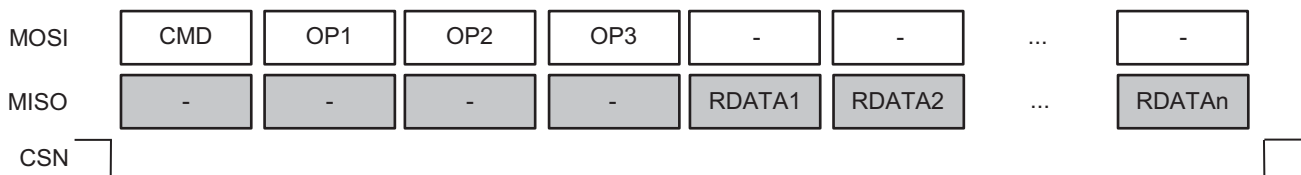

Figure 17-21. SPI Command w/ Read Data (e.g. LSC_READ_STATUS)



SPI Functional Waveforms

Figure 17-22. Fully Specified SPI Transaction (MachXO2 as SPI Master or Slave)

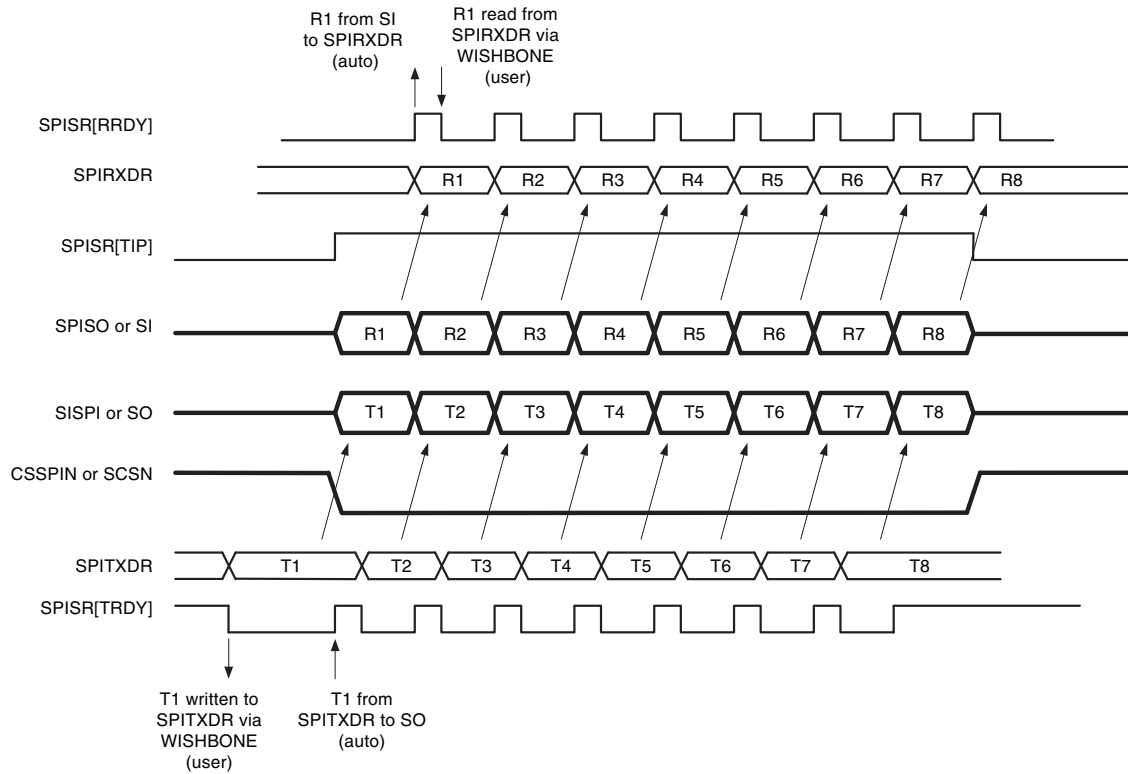
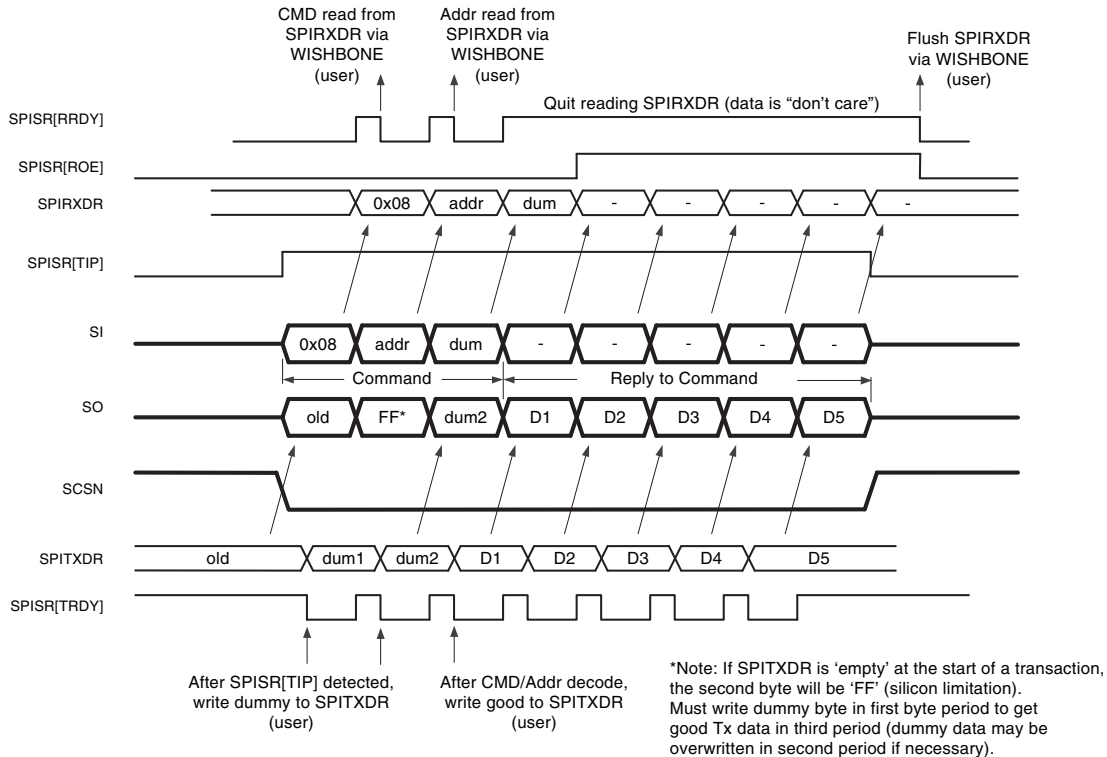

Figure 17-23. Minimally Specified SPI Transaction Example (MachXO2 as SPI Slave)



SPI Timing Diagrams

Figure 17-24. SPI Control Timing (SPICR2[CPHA]=0, SPICR1[TXEDGE]=0)

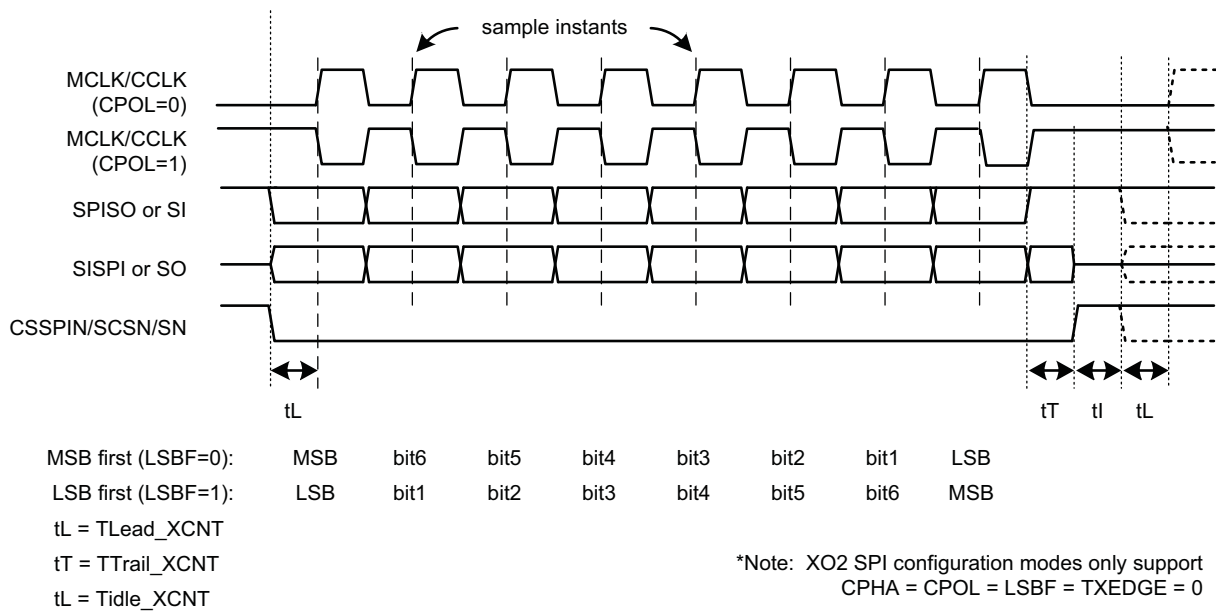

Figure 17-25. SPI Control Timing (SPICR2[CPHA]=1, SPICR1[TXEDGE]=0)

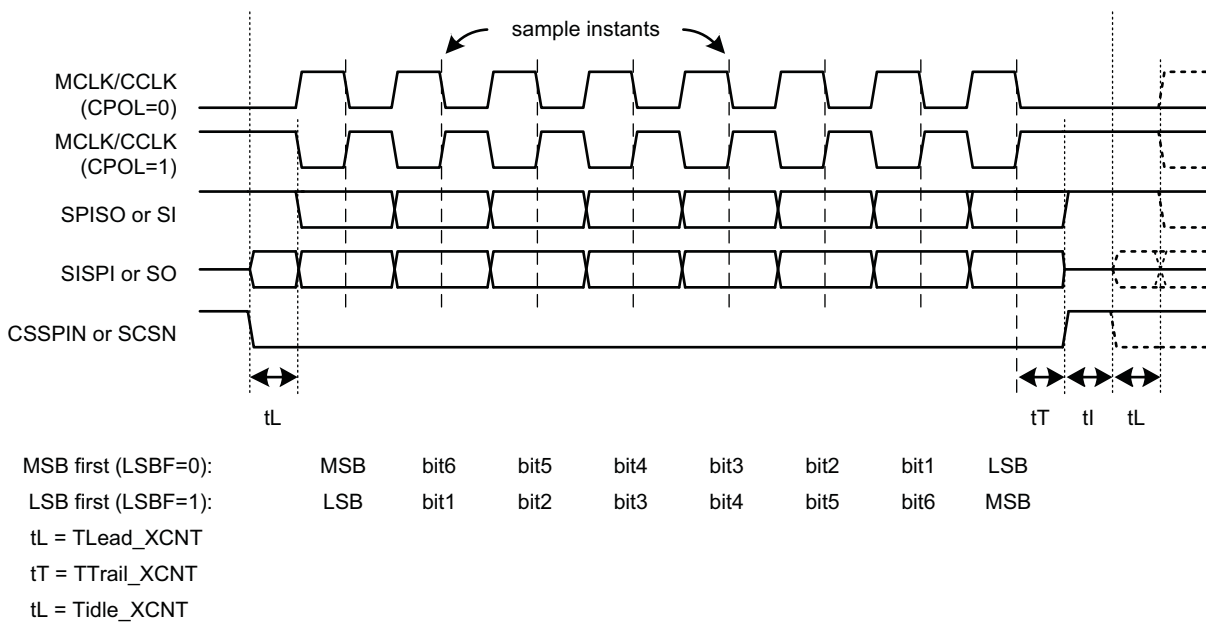

Figure 17-26. SPI Control Timing (SPICR2[CPHA]=0, SPICR1[TXEDGE]=1)

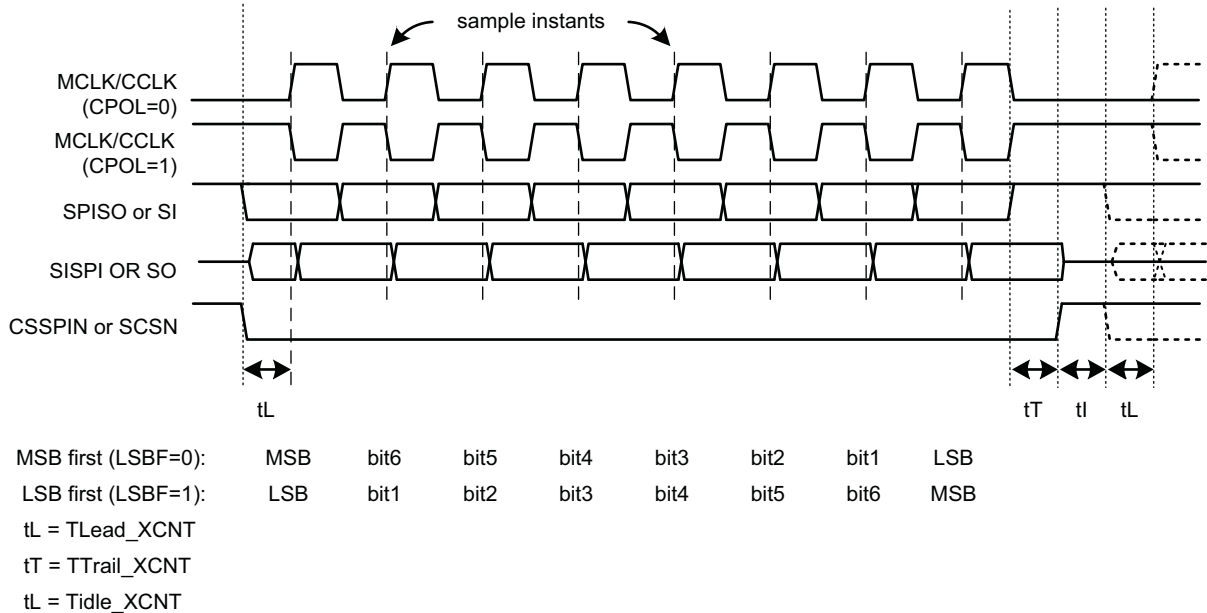

Figure 17-27. SPI Control Timing (SPICR2[CPHA]=1, SPICR1[TXEDGE]=1)

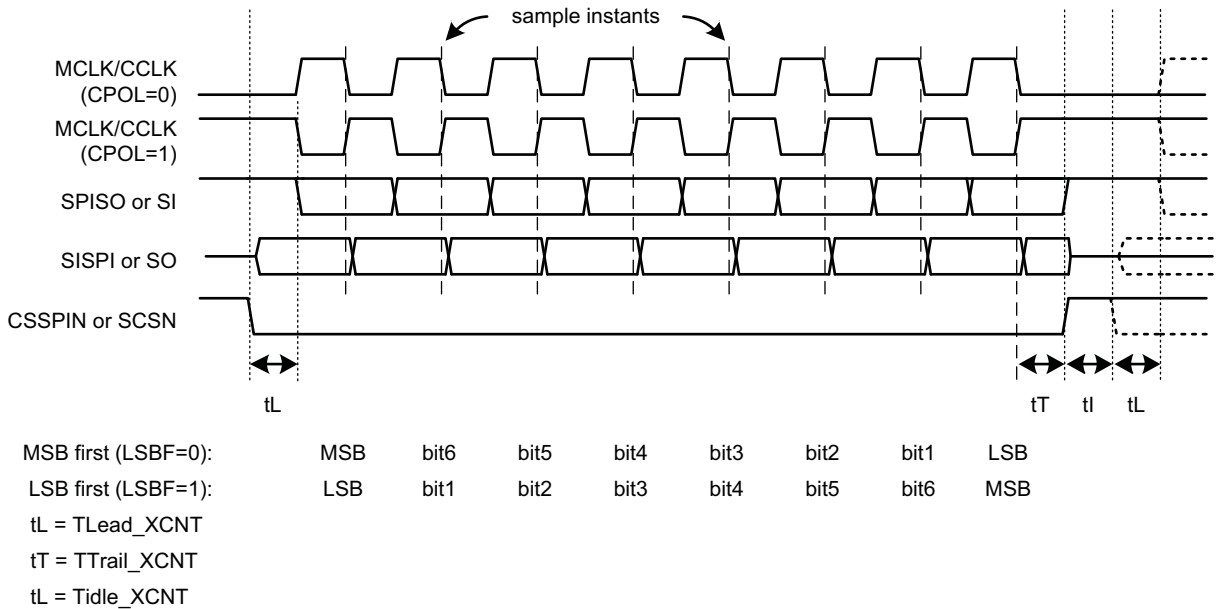
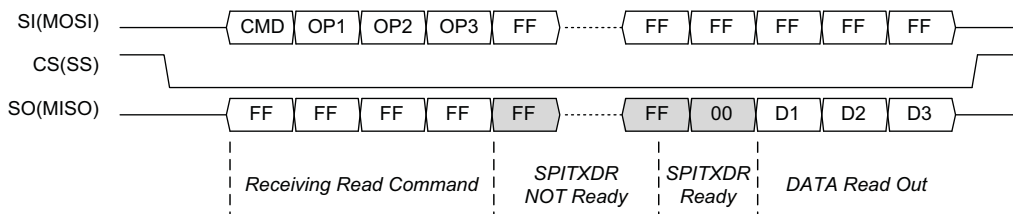

Figure 17-28. Slave SPI Dummy Byte Response (SPICR2[SDBRE]) Timing



SPI Simulation Model

The SPI EFB Register Map translation to the MachXO2 EFB software simulation model is provided below.

Table 17-27. SPI Simulation Model

SPI Register Name	Register Size/Bit Location	Register Function	Address	Access	Simulation Model Register Name	Simulation Model Register Path
SPICR0	[7:0]	Control Register 0	0x54	Read/Write	spicr0[7:0]	../efb_top/config_plus_inst/config_core_inst/cfg_cdu/njport_unit/spi_port/
TIdle_XCNT[1:0]	[7:6]				spicr0[7:6]	../efb_top/config_plus_inst/config_core_inst/cfg_cdu/njport_unit/spi_port/
TRail_XCNT[2:0]	[5:3]				spicr0[5:3]	../efb_top/config_plus_inst/config_core_inst/cfg_cdu/njport_unit/spi_port/
TLead_XCNT[2:0]	[2:0]				spicr0[2:0]	../efb_top/config_plus_inst/config_core_inst/cfg_cdu/njport_unit/spi_port/
SPICR1	[7:0]	Control Register 1	0x55	Read/Write	spicr1[7:0]	../efb_top/config_plus_inst/config_core_inst/cfg_cdu/njport_unit/spi_port/
SPE	7				spi_en	../efb_top/config_plus_inst/config_core_inst/cfg_cdu/njport_unit/spi_port/
WKUPEN_USER	6				spi_wkup_usr	../efb_top/config_plus_inst/config_core_inst/cfg_cdu/njport_unit/spi_port/
WKUPEN_CFG	5				spi_wkup_cfg	../efb_top/config_plus_inst/config_core_inst/cfg_cdu/njport_unit/spi_port/
TXEDGE	4				spi_tx_edge	../efb_top/config_plus_inst/config_core_inst/cfg_cdu/njport_unit/spi_port/
SPICR2	[7:0]	Control Register 2	0x56	Read/Write	spicr2[7:0]	../efb_top/config_plus_inst/config_core_inst/cfg_cdu/njport_unit/spi_port/
MSTR	7				spi_mstr	../efb_top/config_plus_inst/config_core_inst/cfg_cdu/njport_unit/spi_port/
MCSH	6				spi_mcsh	../efb_top/config_plus_inst/config_core_inst/cfg_cdu/njport_unit/spi_port/
SDBRE	5				spi_srme	../efb_top/config_plus_inst/config_core_inst/cfg_cdu/njport_unit/spi_port/
CPOL	2				spi_cpol	../efb_top/config_plus_inst/config_core_inst/cfg_cdu/njport_unit/spi_port/
CPHA	1				spi_cpha	../efb_top/config_plus_inst/config_core_inst/cfg_cdu/njport_unit/spi_port/
LSBF	0				spi_lsb	../efb_top/config_plus_inst/config_core_inst/cfg_cdu/njport_unit/spi_port/
SPIBR	[7:0]	Clock Pre-scale	0x57	Read/Write	spibr[7:0]	../efb_top/config_plus_inst/config_core_inst/cfg_cdu/njport_unit/spi_port/
DIVIDER[5:0]	[5:0]				spibr[5:0]	../efb_top/config_plus_inst/config_core_inst/cfg_cdu/njport_unit/spi_port/
SPICSR	[7:0]	Master Chip Select	0x58	Read/Write	spicsr[7:0]	../efb_top/config_plus_inst/config_core_inst/cfg_cdu/njport_unit/spi_port/
CSN_7	7				spicsr[7]	../efb_top/config_plus_inst/config_core_inst/cfg_cdu/njport_unit/spi_port/
CSN_6	6				spicsr[6]	../efb_top/config_plus_inst/config_core_inst/cfg_cdu/njport_unit/spi_port/
CSN_5	5				spicsr[5]	../efb_top/config_plus_inst/config_core_inst/cfg_cdu/njport_unit/spi_port/
CSN_4	4				spicsr[4]	../efb_top/config_plus_inst/config_core_inst/cfg_cdu/njport_unit/spi_port/
CSN_3	3				spicsr[3]	../efb_top/config_plus_inst/config_core_inst/cfg_cdu/njport_unit/spi_port/
CSN_2	2				spicsr[2]	../efb_top/config_plus_inst/config_core_inst/cfg_cdu/njport_unit/spi_port/
CSN_1	1				spicsr[1]	../efb_top/config_plus_inst/config_core_inst/cfg_cdu/njport_unit/spi_port/
CSN_0	0				spicsr[0]	../efb_top/config_plus_inst/config_core_inst/cfg_cdu/njport_unit/spi_port/
SPITXDR	[7:0]	Transmit Data	0x59	Write	spitxdr[7:0]	../efb_top/config_plus_inst/config_core_inst/cfg_cdu/njport_unit/spi_port/
SPI_Transmit_Data[7:0]	[7:0]				spitxdr[7:0]	../efb_top/config_plus_inst/config_core_inst/cfg_cdu/njport_unit/spi_port/

Table 17-27. SPI Simulation Model (Continued)

SPI Register Name	Register Size/Bit Location	Register Function	Address	Access	Simulation Model Register Name	Simulation Model Register Path
SPISR	[7:0]	Status	0x5A	Read	spisr[7:0]	../efb_top/config_plus_inst/config_core_inst/cfg_cdu/njport_unit/spi_port/
TIP	7				spi_tip_sync	../efb_top/config_plus_inst/config_core_inst/cfg_cdu/njport_unit/spi_port/
TRDY	4				spi_trdy	../efb_top/config_plus_inst/config_core_inst/cfg_cdu/njport_unit/spi_port/
RRDY	3				spi_rrdy	../efb_top/config_plus_inst/config_core_inst/cfg_cdu/njport_unit/spi_port/
ROE	1				spi_roe	../efb_top/config_plus_inst/config_core_inst/cfg_cdu/njport_unit/spi_port/
MDF	0				spi_mdf	../efb_top/config_plus_inst/config_core_inst/cfg_cdu/njport_unit/spi_port/
SPIRXDR	[7:0]	Receive Data	0x5B	Read	spirxdr[7:0]	../efb_top/config_plus_inst/config_core_inst/cfg_cdu/njport_unit/spi_port/
SPI_Receive_Data[7:0]	[7:0]				spirxdr[7:0]	../efb_top/config_plus_inst/config_core_inst/cfg_cdu/njport_unit/spi_port/
SPIIRQ	[7:0]	Interrupt Request	0x5C	Read/Write	{1'b0, 1'b0, 1'b0, spisr_irqsts_4, spisr_irqsts_3, spisr_irqsts_2, spisr_irqsts_1, spisr_irqsts_0}	../efb_top/efb_pll_sci_inst/u_efb_sci/
IRQTRDY	4				spisr_irqsts_4	../efb_top/efb_pll_sci_inst/u_efb_sci/
IRQRRDY	3				spisr_irqsts_3	../efb_top/efb_pll_sci_inst/u_efb_sci/
IRQROE	1				spisr_irqsts_1	../efb_top/efb_pll_sci_inst/u_efb_sci/
IRQMDF	0				spisr_irqsts_0	../efb_top/efb_pll_sci_inst/u_efb_sci/
SPIIRQEN	[7:0]	Interrupt Request Enable	0x5D	Read/Write	{1'b0, 1'b0, 1'b0, spisr_irqena_4, spisr_irqena_3, spisr_irqena_2, spisr_irqena_1, spisr_irqena_0}	../efb_top/efb_pll_sci_inst/u_efb_sci/
IRQTRDYEN	4				spisr_irqena_4	../efb_top/efb_pll_sci_inst/u_efb_sci/
IRQRRDYEN	3				spisr_irqena_3	../efb_top/efb_pll_sci_inst/u_efb_sci/
IRQROEEN	1				spisr_irqena_1	../efb_top/efb_pll_sci_inst/u_efb_sci/
IRQMDFEN	0				spisr_irqena_0	../efb_top/efb_pll_sci_inst/u_efb_sci/

Hardened Timer/Counter PWM

The MachXO2 EFB contains a hard Timer/Counter IP core. This Timer/Counter is a general purpose, bi-directional, 16-bit Timer/Counter module with independent output compare units and PWM support.

Timer/Counter Registers

The Timer/Counter communicates with the FPGA logic through the WISHBONE interface, by utilizing a set of control, status and data registers. Table 17-28 shows the register names and their functions. These registers are a subset of the EFB register map. Refer to the EFB register map for specific addresses of each register.

Table 17-28. Timer/Counter Registers

Timer/Counter Register Name	Register Function	Address	Access
TCCR0	Control Register 0	0x5E	Read/Write
TCCR1	Control Register 1	0x5F	Read/Write
TCTOPSET0	Set Top Counter Value [7:0]	0x60	Write
TCTOPSET1	Set Top Counter Value [15:8]	0x61	Write
TCOCRSET0	Set Compare Counter Value [7:0]	0x62	Write
TCOCRSET1	Set Compare Counter Value [15:8]	0x63	Write
TCCR2	Control Register 2	0x64	Read/Write
TCCNT0	Counter Value [7:0]	0x65	Read
TCCNT1	Counter Value [15:8]	0x66	Read
TCTOP0	Current Top Counter Value [7:0]	0x67	Read
TCTOP1	Current Top Counter Value [15:8]	0x68	Read
TCOCR0	Current Compare Counter Value [7:0]	0x69	Read
TCOCR1	Current Compare Top Counter Value [15:8]	0x6A	Read
TCICR0	Current Capture Counter Value [7:0]	0x6B	Read
TCICR1	Current Capture Counter Value [15:8]	0x6C	Read
TCSR0	Status Register	0x6D	Read/Write
TCIRQ	Interrupt Request	0x6E	Read/Write
TCIRQEN	Interrupt Request Enable	0x6F	Read/Write

Note: Unless otherwise specified, all Reserved bits in writable registers shall be written '0'.

Table 17-29. Timer/Counter Control 0

TCCR0							0x5E	
Bit	7	6	5	4	3	2	1	0
Name	RSTEN	(Reserved)	PRESCALE[2:0]			CLKEDGE	CLKSEL	(Reserved)
Default	0	0	0			0	0	0
Access	R/W	—	R/W			R/W	R/W	R/W

RSTEN Enables the reset signal (tc_rstn) to enter the Timer/Counter core from the PLD logic.
 1: External reset enabled
 0: External reset disabled

- PRESCALE[2:0]** Used to divide the clock input to the Timer/Counter
 000: Static (clock disabled)
 001: Divide by 1
 010: Divide by 8
 011: Divide by 64
 100: Divide by 256
 101: Divide by 1024
 110: (Reserved setting)
 111: (Reserved setting)
- CLKEDGE** Used to select the edge of the input clock source. The Timer/Counter will update states on the edge of the input clock source.
 0: Rising Edge
 1: Falling Edge
- CLKSEL** Defines the source of the input clock.
 0: Clock Tree
 1: On-chip Oscillator

Table 17-30. Timer/Counter Control 1

TCCR1								0x5F
Bit	7	6	5	4	3	2	1	0
Name	(Reserved)	SOVFEN	ICEN	TSEL	OCM[1:0]		TCM[1:0]	
Default	0	0	0	0	0		0	
Access	—	R/W	R/W	R/W	R/W		R/W	

- SOVFEN** Enables the overflow flag to be used with the interrupt output signal. It is set when the Timer/Counter is standalone, with no WISHBONE interface.
 0: Disabled
 1: Enabled
- Note: When this bit is set, other flags such as the OCRF and ICRF will not be routed to the interrupt output signal.*
- ICEN** Enables the ability to perform a capture operation of the counter value. Users can assert the “tc_ic” signal and load the counter value onto the TCICR0/1 registers. The captured value can serve as a timer stamp for a specific event.
 0: Disabled
 1: Enabled
- TSEL** Enables the auto-load of the counter with the value from TCTOPSET0/1. When disabled, the value 0xFFFF is auto-loaded.
 0: Disabled
 1: Enabled
- OCM[1:0]** Select the function of the output signal of the Timer/Counter. The available functions are Static, Toggle, Set/Clear and Clear/Set.
- All Timer/Counter modes:
 00: The output is static low
- In non-PWM modes:
 01: Toggle on TOP match

In Fast PWM mode:

- 10: Clear on TOP match, Set on OCR match
- 11: Set on TOP match, Clear on OCR match

In Phase and Frequency Correct PWM mode:

- 10: Clear on OCR match when the counter is incrementing

Set on OCR match when counter is decrementing

- 11: Set on OCR match when the counter is incrementing

Clear on OCR match when the counter is decrementing

TCM[1:0]

Timer Counter Mode. Defines the mode of operation for the Timer/Counter.

- 00: Watchdog Timer Mode
- 01: Clear Timer on Compare Match Mode
- 10: Fast PWM Mode
- 11: Phase and Frequency Correct PWM Mode

Table 17-31. Timer/Counter Set Top Counter Value 0

TCTOPSET0								0x60
Bit	7	6	5	4	3	2	1	0
Name	TCTOPSET[7:0]							
Default ¹	1	1	1	1	1	1	1	1
Access	R/W	R/W	R/W	R/W	R/W	R/W	R/W	R/W

1. Hardware default value may be overridden by EFB component instantiation parameters.

Table 17-32. Timer/Counter Set Top Counter Value 1

TCTOPSET1								0x61
Bit	7	6	5	4	3	2	1	0
Name	TCTOPSET[15:8]							
Default ¹	1	1	1	1	1	1	1	1
Access	R/W	R/W	R/W	R/W	R/W	R/W	R/W	R/W

1. Hardware default value may be overridden by EFB component instantiation parameters.

The value from TCTOPSET0/1 is loaded to the TCTOP0/1 registers once the counter has completed the current counting cycle. Refer to the Timer/Counter Modes of Operation section for usage details.

TCTOPSET0 register holds the lower eight bits [7:0] of the top value. TCTOPSET1 register holds the upper eight bits [15:8] of the top value.

Table 17-33. Timer/Counter Set Compare Counter Value 0

TCOCRSET0								0x62
Bit	7	6	5	4	3	2	1	0
Name	TCOCRSET[7:0]							
Default ¹	1	1	1	1	1	1	1	1
Access	R/W	R/W	R/W	R/W	R/W	R/W	R/W	R/W

1. Hardware default value may be overridden by EFB component instantiation parameters.

Table 17-34. Timer/Counter Set Compare Counter Value 1

TCOCRSET1								0x63
Bit	7	6	5	4	3	2	1	0
Name	TCOCRSET[15:8]							
Default ¹	1	1	1	1	1	1	1	1
Access	R/W	R/W	R/W	R/W	R/W	R/W	R/W	R/W

1. Hardware default value may be overridden by EFB component instantiation parameters.

The value from TCOCRSET0/1 is loaded to the TCOCR0/1 registers once the counter has completed the current counting cycle. Refer to the Timer/Counter Modes of Operation section for usage details.

TCOCRSET0 register holds the lower 8-bit value [7:0] of the compare value. TCOCRSET1 register holds the upper 8-bit value[15:8] of the compare value.

Table 17-35. Timer/Counter Control 2

TCCR2							0x64	
Bit	7	6	5	4	3	2	1	0
Name	(Reserved)					WBFORCE	WBRESET	WBPAUSE
Default	0	0	0	0	0	0	0	0
Access	—	—	—	—	—	R/W	R/W	R/W

WBFORCE In non-PWM modes, forces the output of the counter, as if the counter value matched the compare (TCOCR) value or it matched the top value (TCTOP).

- 0: Disabled
- 1: Enabled

WBRESET Reset the counter from the WISHBONE interface by writing a '1' to this bit. Manually reset to '0'. The rising edge is detected in the WISHBONE clock domain, and the counter is reset synchronously on the next tc_clk. Due to the clock domain crossing, there is a one-clock uncertainty when the reset is effective. This bit has higher priority than WBPAUSE.

- 0: Disabled
- 1: Enabled

WBPAUSE Pause the 16-bit counter

- 1: Pause
- 0: Normal

Table 17-36. Timer/Counter Counter Value 0

TCCNT0								0x65
Bit	7	6	5	4	3	2	1	0
Name	TCCNT[7:0]							
Default	0	0	0	0	0	0	0	0
Access	R	R	R	R	R	R	R	R

Table 17-37. Timer/Counter Counter Value 1

TCCNT1								0x66
Bit	7	6	5	4	3	2	1	0
Name	TCCNT[15:8]							
Default	0	0	0	0	0	0	0	0
Access	R	R	R	R	R	R	R	R

Registers TCCNT0 and TCCNT1 are 8-bit registers, which combined, hold the counter value. The WISHBONE host has read-only access to these registers.

TCCNT0 register holds the lower 8-bit value [7:0] of the counter value. TCCNT1 register holds the upper 8-bit value [15:8] of the counter value.

Table 17-38. Timer/Counter Current Top Counter Value 0

TCTOP0								0x67
Bit	7	6	5	4	3	2	1	0
Name	TCTOP[7:0]							
Default	1	1	1	1	1	1	1	1
Access	R	R	R	R	R	R	R	R

Table 17-39. Timer/Counter Current Top Counter Value 1

TCTOP1								0x68
Bit	7	6	5	4	3	2	1	0
Name	TCTOP[15:8]							
Default	1	1	1	1	1	1	1	1
Access	R	R	R	R	R	R	R	R

Registers TCTOP0 and TCTOP1 are 8-bit registers, which combined, receive a 16-bit value from the TCTOP-SET0/1. The data stored in these registers represents the top value of the counter. The registers update once the counter has completed the current counting cycle. The WISHBONE host has read-only access to these registers. Refer to the Timer/Counter Modes of Operation section for usage details.

TCTOP0 register holds the lower 8-bit value [7:0] of the top value. TCTOP1 register holds the upper 8-bit value [15:8] of the top value.

Table 17-40. Timer/Counter Current Compare Counter Value 0

TCOCR0								0x69
Bit	7	6	5	4	3	2	1	0
Name	TCOCR[7:0]							
Default	1	1	1	1	1	1	1	1
Access	R	R	R	R	R	R	R	R

Table 17-41. Timer/Counter Current Compare Counter Value 1

TCOCR1								0x6A
Bit	7	6	5	4	3	2	1	0
Name	TCOCR[15:8]							
Default	1	1	1	1	1	1	1	1
Access	R	R	R	R	R	R	R	R

Registers TCOCR0 and TCOCR1 are 8-bit registers, which combined, receive a 16-bit value from the TCO-CRSET0/1. The data stored in these registers represents the compare value of the counter. The registers update once the counter has completed the current counting cycle. The WISHBONE host has read-only access to these registers. Refer to the Timer/Counter Modes of Operation section for usage details.

TCOCR0 register holds the lower 8-bit value [7:0] of the compare value. TCOCR1 register holds the upper 8-bit value [15:8] of the compare value.

Table 17-42. Timer/Counter Current Capture Counter Value 0

TCICR0								0x6B
Bit	7	6	5	4	3	2	1	0
Name	TCICR[7:0]							
Default	0	0	0	0	0	0	0	0
Access	R	R	R	R	R	R	R	R

Table 17-43. Timer/Counter Current Capture Counter Value 1

TCICR1								0x6C
Bit	7	6	5	4	3	2	1	0
Name	TCICR[15:8]							
Default	0	0	0	0	0	0	0	0
Access	R	R	R	R	R	R	R	R

Registers TCICR0 and TCICR1 are 8-bit registers, which combined, can hold the counter value. The counter value is loaded onto these registers once a trigger event, tc_ic IP signal, is asserted. The capture value is commonly used as a time-stamp for a specific system event. The WISHBONE host has read-only access to these registers.

TCICR0 register holds the lower 8-bit value [7:0] of the counter value. TCICR1 register holds the upper 8-bit value [15:8] of the counter value.

Table 17-44. Timer/Counter Status Register

TCSR0								0x6D
Bit	7	6	5	4	3	2	1	0
Name	(Reserved)				BTF	ICRF	OCRF	OVF
Default	—	—	—	—	0	0	0	0
Access	—	—	—	—	R	R	R	R

BTF Bottom Flag. Asserted when the counter reaches value zero. A write operation to this register clears this flag.

- 1: Counter reached zero value
- 0: Counter has not reached zero

ICRF Capture Counter Flag. Asserted when the user asserts the TC_IC input signal. The counter value is captured into the TCICR0/1 registers. A write operation to this register clears this flag. This bit is capable of generating an interrupt.

- 1: TC_IC signal asserted.
- 0: Normal

OCRF Compare Match Flag. Asserted when counter matches the TCOCR0/1 register value. A write operation to this register clears this flag. This bit is capable of generating an interrupt.

- 1: Counter match
- 0: Normal

OVF Overflow Flag. Asserted when the counter matches the TCTOP0/1 register value. A write operation to this register clears this flag. This bit is capable of generating an interrupt.

- 1: Counter match
- 0: Normal

Table 17-45. Timer/Counter Interrupt Status

TCIRQ								0x6E
Bit	7	6	5	4	3	2	1	0
Name	(Reserved)					IRQICRF	IRQOCRF	IRQOVF
Default	0	0	0	0	0	0	0	0
Access	—	—	—	—	—	R/W	R/W	R/W

IRQICRF Interrupt Status for Capture Counter Flag.
When enabled, indicates ICRF was asserted. Write a '1' to this bit to clear the interrupt.

- 1: Capture Counter Flag Interrupt
- 0: No interrupt

IRQOCRF Interrupt Status for Compare Match Flag.
When enabled, indicates OCRF was asserted. Write a '1' to this bit to clear the interrupt.

- 1: Compare Match Flag Interrupt
- 0: No interrupt

IRQOVF Interrupt Status for Overflow Flag.
When enabled, indicates OVF was asserted. Write a '1' to this bit to clear the interrupt.

- 1: Overflow Flag Interrupt
- 0: No interrupt

Table 17-46. Timer/Counter Interrupt Enable

TCIRQEN								0x6F
Bit	7	6	5	4	3	2	1	0
Name	(Reserved)					IRQICRFEN	IRQOCRFEN	IRQOVFEN
Default	0	0	0	0	0	0	0	0
Access	—	—	—	—	—	R/W	R/W	R/W

IRQICRFEN Interrupt Enable for Capture Counter Flag.

- 1: Interrupt generation enabled
- 0: Interrupt generation disabled

IRQOCRFEN Interrupt Enable for Compare Match Flag.

- 1: Interrupt generation enabled
- 0: Interrupt generation disabled

IRQOVFEN Interrupt Enable for Overflow Flag.

- 1: Interrupt generation enabled
- 0: Interrupt generation disabled

Timer Counter Simulation Model

The Timer Counter EFB Register Map translation to the MachXO2 EFB software simulation model is provided below.

Table 17-47. Timer/Counter Simulation Mode

Timer/Counter Register Name	Register Size/Bit Location	Register Function	Address	Access	Simulation Model Register Name	Simulation Model Register Path
TCCR0	[7:0]	Control Register 0	0x5E	Read/Write	{tc_rstn_ena, tc_gsrn_dis, tc_cclk_sel[2:0], tc_sclk_sel[2:0]}	../efb_top/efb_pll_sci_inst/u_efb_sci/
RSTEN	7				tc_rstn_ena	../efb_top/efb_pll_sci_inst/u_efb_sci/
PRESCALE[2:0]	[5:3]				tc_cclk_sel[2:0]	../efb_top/efb_pll_sci_inst/u_efb_sci/
CLKEDGE	2				tc_sclk_sel[2]	../efb_top/efb_pll_sci_inst/u_efb_sci/
CLKSEL	1				tc_sclk_sel[1]	../efb_top/efb_pll_sci_inst/u_efb_sci/
TCCR1	[7:0]	Control Register 1	0x5F	Read/Write	{1'b0, tc_ovf_ena, tc_ic_ena, tc_top_sel, tc_oc_mode[1:0], tc_mode[1:0]}	../efb_top/efb_pll_sci_inst/u_efb_sci/
SOVFEN	6				tc_ivf_ena	../efb_top/efb_pll_sci_inst/u_efb_sci/
ICEN	5				tc_ic_ena	../efb_top/efb_pll_sci_inst/u_efb_sci/
TSEL	4				tc_top_sel	../efb_top/efb_pll_sci_inst/u_efb_sci/
OCM[1:0]	[3:2]				tc_oc_mode[1:0]	../efb_top/efb_pll_sci_inst/u_efb_sci/
TCM[1:0]	[1:0]				tc_mode[1:0]	../efb_top/efb_pll_sci_inst/u_efb_sci/
TCTOPSET0	[7:0]	Set Top Counter Value [7:0]	0x60	Write	{tc_top_set[7], tc_top_set[6], tc_top_set[5], tc_top_set[4], tc_top_set[3], tc_top_set[2], tc_top_set[1], tc_top_set[0]}	../efb_top/efb_pll_sci_inst/u_efb_sci/
TCTOPSET[7:0]	[7:0]				{tc_top_set[7], tc_top_set[6], tc_top_set[5], tc_top_set[4], tc_top_set[3], tc_top_set[2], tc_top_set[1], tc_top_set[0]}	../efb_top/efb_pll_sci_inst/u_efb_sci/
TCTOPSET1	[7:0]	Set Top Counter Value [15:8]	0x61	Write	{tc_top_set[15], tc_top_set[14], tc_top_set[13], tc_top_set[12], tc_top_set[11], tc_top_set[10], tc_top_set[9], tc_top_set[8]}	../efb_top/efb_pll_sci_inst/u_efb_sci/
TCTOPSET[15:8]	[7:0]				{tc_top_set[15], tc_top_set[14], tc_top_set[13], tc_top_set[12], tc_top_set[11], tc_top_set[10], tc_top_set[9], tc_top_set[8]}	../efb_top/efb_pll_sci_inst/u_efb_sci/
TCOCRSET0	[7:0]	Set Compare Counter Value [7:0]	0x62	Write	{tc_ocr_set[7], tc_ocr_set[6], tc_ocr_set[5], tc_ocr_set[4], tc_ocr_set[3], tc_ocr_set[2], tc_ocr_set[1], tc_ocr_set[0]}	../efb_top/efb_pll_sci_inst/u_efb_sci/
TCOCRSET[7:0]	[7:0]				{tc_ocr_set[7], tc_ocr_set[6], tc_ocr_set[5], tc_ocr_set[4], tc_ocr_set[3], tc_ocr_set[2], tc_ocr_set[1], tc_ocr_set[0]}	../efb_top/efb_pll_sci_inst/u_efb_sci/
TCOCRSET1	[7:0]	Set Compare Counter Value [15:8]	0x63	Write	{tc_ocr_set[15], tc_ocr_set[14], tc_ocr_set[13], tc_ocr_set[12], tc_ocr_set[11], tc_ocr_set[10], tc_ocr_set[9], tc_ocr_set[8]}	../efb_top/efb_pll_sci_inst/u_efb_sci/
TCOCRSET[15:8]	[7:0]				{tc_ocr_set[15], tc_ocr_set[14], tc_ocr_set[13], tc_ocr_set[12], tc_ocr_set[11], tc_ocr_set[10], tc_ocr_set[9], tc_ocr_set[8]}	../efb_top/efb_pll_sci_inst/u_efb_sci/
TCCR2	[7:0]	Control Register 2	0x64	Read/Write	{1'b0, 1'b0, 1'b0, 1'b0, 1'b0, tc_oc_force, tc_cnt_reset, tc_cnt_pause}	../efb_top/efb_pll_sci_inst/u_efb_sci/
WBFORCE	2				tc_oc_force	../efb_top/efb_pll_sci_inst/u_efb_sci/
WBRESET	1				tc_cnt_reset	../efb_top/efb_pll_sci_inst/u_efb_sci/
WBPAUSE	0				tc_cnt_pause	../efb_top/efb_pll_sci_inst/u_efb_sci/
TCCNT0	[7:0]	Counter Value [7:0]	0x65	Read	tc_cnt_sts[7:0]	../efb_top/efb_pll_sci_inst/u_efb_sci/
TCCNT[7:0]	[7:0]				tc_cnt_sts[7:0]	../efb_top/efb_pll_sci_inst/u_efb_sci/
TCCNT1	[7:0]	Counter Value [15:8]	0x66	Read	tc_cnt_sts[15:8]	../efb_top/efb_pll_sci_inst/u_efb_sci/
TCCNT[15:8]	[7:0]				tc_cnt_sts[15:8]	../efb_top/efb_pll_sci_inst/u_efb_sci/
TCTOP0	[7:0]	Current Top Counter Value [7:0]	0x67	Read	tc_top_sts[7:0]	../efb_top/efb_pll_sci_inst/u_efb_sci/
TCTOP[7:0]	[7:0]				tc_top_sts[7:0]	../efb_top/efb_pll_sci_inst/u_efb_sci/

Table 17-47. Timer/Counter Simulation Mode (Continued)

Timer/Counter Register Name	Register Size/Bit Location	Register Function	Address	Access	Simulation Model Register Name	Simulation Model Register Path
TCTOP1	[7:0]	Current Top Counter Value [15:8]	0x68	Read	tc_top_sts[15:8]	../efb_top/efb_pll_sci_inst/u_efb_sci/
TCTOP[15:8]	[7:0]				tc_top_sts[15:8]	../efb_top/efb_pll_sci_inst/u_efb_sci/
TCOCR0	[7:0]	Current Compare Counter Value [7:0]	0x69	Read	tc_ocr_sts[7:0]	../efb_top/efb_pll_sci_inst/u_efb_sci/
TCOCR[7:0]	[7:0]				tc_ocr_sts[7:0]	../efb_top/efb_pll_sci_inst/u_efb_sci/
TCOCR1	[7:0]	Current Compare Top Counter Value [15:8]	0x6A	Read	tc_ocr_sts[15:8]	../efb_top/efb_pll_sci_inst/u_efb_sci/
TCOCR[15:8]	[7:0]				tc_ocr_sts[15:8]	../efb_top/efb_pll_sci_inst/u_efb_sci/
TCICR0	[7:0]	Current Capture Counter Value [7:0]	0x6B	Read	tc_icr_sts[7:0]	../efb_top/efb_pll_sci_inst/u_efb_sci/
TCICR[7:0]	[7:0]				tc_icr_sts[7:0]	../efb_top/efb_pll_sci_inst/u_efb_sci/
TCICR1	[7:0]	Current Capture Counter Value [15:8]	0x6C	Read	tc_icr_sts[15:8]	../efb_top/efb_pll_sci_inst/u_efb_sci/
TCICR[15:8]	[7:0]				tc_icr_sts[15:8]	../efb_top/efb_pll_sci_inst/u_efb_sci/
TCSR0	[7:0]	Status Register	0x6D	Read	{1'b0, 1'b0, 1'b0, 1'b0, tc_btf_sts, tc_icrf_sts, tc_ocrf_sts, tc_ovf_sts}	../efb_top/efb_pll_sci_inst/u_efb_sci/
BTF	3				tc_btf_sts	../efb_top/efb_pll_sci_inst/u_efb_sci/
ICRF	2				tc_icrf_sts	../efb_top/efb_pll_sci_inst/u_efb_sci/
OCRF	1				tc_ocrf_sts	../efb_top/efb_pll_sci_inst/u_efb_sci/
OVF	0				tc_ovf_sts	../efb_top/efb_pll_sci_inst/u_efb_sci/
TCIRQ	[7:0]	Interrupt Request	0x6E	Read/Write	{1'b0, 1'b0, 1'b0, 1'b0, 1'b0, tc_icrf_irqsts, tc_ocrf_irqsts, tc_ovf_irqsts}	../efb_top/efb_pll_sci_inst/u_efb_sci/
IRQICRF	2				tc_icrf_irqsts	../efb_top/efb_pll_sci_inst/u_efb_sci/
IRQOCRF	1				tc_ocrf_irqsts	../efb_top/efb_pll_sci_inst/u_efb_sci/
IRQOVF	0				tc_ovf_irqsts	../efb_top/efb_pll_sci_inst/u_efb_sci/
TCIRQEN	[7:0]	Interrupt Request Enable	0x6F	Read/Write	{1'b0, 1'b0, 1'b0, 1'b0, 1'b0, tc_icrf_irqena, tc_ocrf_irqena, tc_ovf_irqena}	../efb_top/efb_pll_sci_inst/u_efb_sci/
IRQICRFEN	2				tc_icrf_irqena	../efb_top/efb_pll_sci_inst/u_efb_sci/
IRQOCRFEN	1				tc_ocrf_irqena	../efb_top/efb_pll_sci_inst/u_efb_sci/
IRQOVFEN	0				tc_ovf_irqena	../efb_top/efb_pll_sci_inst/u_efb_sci/

Flash Memory (UFM/Configuration) Access

Designers can access the Flash Memory Configuration Logic interface using the JTAG, SPI, I²C, or WISHBONE interfaces. The MachXO2 Flash Memory consists of two sectors:

- User Flash Memory (UFM)
 - MachXO2-640 and higher density devices provide one sector of User Flash Memory (UFM).
- Configuration
 - Configuration consists of two sectors Configuration Flash and the Feature Row.

The UFM is a Flash sector which is organized in pages. The UFM is not byte addressable. Each page has 128 bits (16 bytes).

Flash Memory (UFM/Configuration) Access Ports

Designers can access the UFM Sector via JTAG port (compliant with the IEEE 1149.1 and IEEE 1532 specifications), external Slave SPI port and external I²C Primary port and the internal WISHBONE interface of the EFB module. Figure 17-29 illustrates the interfaces to the UFM and Configuration Memory sectors.

Figure 17-29. Interfaces to the UFM/Configuration Sectors

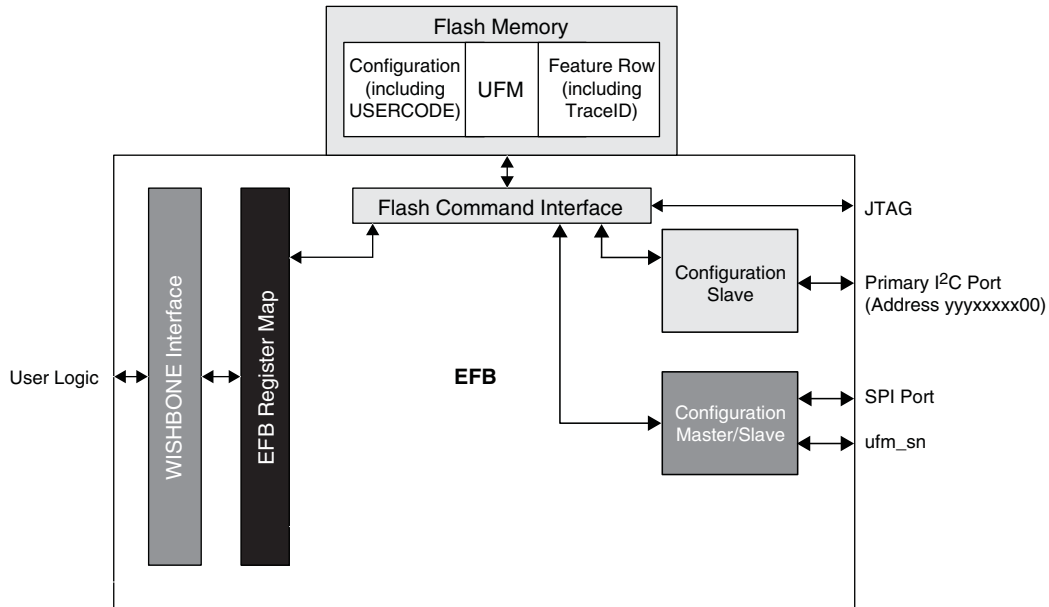

The configuration logic arbitrates access from the interfaces by the following priority. When higher priority ports are enabled Flash Memory access by lower priority ports will be blocked.

1. JTAG Port
2. Slave SPI Port
3. I²C Primary Port
4. WISHBONE Slave Interface

Note: Enabling Flash Memory (UFM/Configuration) Interface using Enable Configuration Interface command 0x74 Transparent Mode will temporarily disable certain features of the device including:

- Power Controller
- GSR
- Hardened User SPI port

Functionality is restored after the Flash Memory (UFM/Configuration) Interface is disabled using Disable Configuration Interface command 0x26 followed by Bypass command 0xFF.

Flash Memory (UFM/Configuration) Access through WISHBONE Slave Interface

The WISHBONE Slave interface of the EFB module enables designers to access the Flash Memory (UFM/Configuration) directly from the FPGA core logic. The WISHBONE bus signals, described earlier in this document, are utilized by a WISHBONE host that designers can implement using the general purpose FPGA resources. In addition to the WISHBONE bus signals, an interrupt request output signal is brought to the FPGA fabric. The IP signal is “wbc_ufm_irq”, and it functions as an interrupt request to the internal WISHBONE host, based on the data Read/Write FIFO status or arbitration error.

Note: To access the Flash Memory (UFM/Configuration) via WISHBONE in R1 devices, the hard SPI port or the primary I²C port must be enabled. For more details, refer to AN8086, [Designing for Migration from MachXO2-1200-R1 to Standard \(Non-R1\) Devices](#).

The WISHBONE Interface communicates to the Configuration Logic through a set of data, control and status registers. Table 17-48 shows the register names and their functions. These registers are a subset of the EFB register map. Refer to the EFB register map for specific addresses of each register.

Table 17-48. WISHBONE to Flash Memory (CFG) Logic Registers

WISHBONE to CFG Register Name	Register Function	Address	Access
CFGCR	Control	0x70	Read/Write
CFGTXDR	Transmit Data	0x71	Write
CFGSR	Status	0x72	Read
CFGRXDR	Receive Data	0x73	Read
CFGIRQ	Interrupt Request	0x74	Read/Write
CFGIRQEN	Interrupt Request Enable	0x75	Read/Write

Note: Unless otherwise specified, all Reserved bits in writable registers shall be written '0'.

Table 17-49. Flash Memory (UFM/Configuration) Control

CFGCR								0x70	
Bit	7	6	5	4	3	2	1	0	
Name	WBCE	RSTE	(Reserved)						
Default	0	0	0	0	0	0	0	0	
Access	R/W	R/W	—	—	—	—	—	—	

WBCE

WISHBONE Connection Enable. Enables the WISHBONE to establish the read/write connection to the Flash Memory (UFM/Configuration) logic. This bit must be set prior to executing any command through the WISHBONE port. Likewise, this bit must be cleared to terminate the command. See “[Command and Data Transfers to Flash Memory \(UFM/Configuration\) Space](#)” on page 51 for more information on framing WISHBONE commands.

- 1: Enabled
- 0: Disabled

RSTE

WISHBONE Connection Reset. Resets the input/output FIFO logic. The reset logic is level sensitive. After setting this bit to '1' it must be cleared to '0' for normal operation.

- 1: Reset
- 0: Normal operation

Table 17-50. Flash Memory (UFM/Configuration) Transmit Data

CFGTXDR								0x71
Bit	7	6	5	4	3	2	1	0
Name	CFG_Transmit_Data[7:0]							
Default	0	0	0	0	0	0	0	0
Access	W	W	W	W	W	W	W	W

CFG_Transmit_Data[7:0] CFG Transmit Data. This register holds the byte that will be written to the Flash Memory (UFM/Configuration) logic. Bit 0 is LSB.

Figure 17-30. Flash Memory (UFM/Configuration) Status

CFGSR								0x72
Bit	7	6	5	4	3	2	1	0
Name	WBCACT	(Reserved)	TXFE	TXFF	RXFE	RXFF	SSPIACT	I2CACT
Default	0	0	0	0	0	0	0	0
Access	R	—	R	R	R	R	R	R

- WBCACT** WISHBONE Bus to Configuration Logic Active. Indicates that the WISHBONE to configuration interface is active and the connection is established.

 - 1: WISHBONE Active
 - 0: WISHBONE not Active

- TXFE** Transmit FIFO Empty. Indicates that the Transmit Data register is empty. This bit is capable of generating an interrupt.

 - 1: FIFO empty
 - 0: FIFO not empty

- TXFF** Transmit FIFO Full. Indicates that the Transmit Data register is full. This bit is capable of generating an interrupt.

 - 1: FIFO full
 - 0: FIFO not full

- RXFE** Receive FIFO Empty. Indicates that the Receive Data register is empty. This bit is capable of generating an interrupt.

 - 1: FIFO empty
 - 0: FIFO not empty

- RXFF** Receive FIFO Full. Indicates that the Transmit Data register is full. This bit is capable of generating an interrupt.

 - 1: FIFO full
 - 0: FIFO not full

- SSPIACT** Slave SPI Active. Indicates the Slave SPI port has started actively communicating with the Configuration Logic while WBCE was enabled. This port has priority over the I²C and WISHBONE ports and will pre-empt any existing, and prohibit any new, lower priority transaction. This bit is capable of generating an interrupt.

 - 1: Slave SPI port active
 - 0: Slave SPI port not active

I2CACT I²C Active. Indicates the I²C port has started actively communicating with the Configuration Logic while WBCE was enabled. This port has priority over the WISHBONE ports and will pre-empt any existing, and prohibit any new WISHBONE transaction. This bit is capable of generating an interrupt.

- 1: I²C port active
- 0: I²C port not active

Table 17-51. Flash Memory (UFM/Configuration) Receive Data

CFGRXDR								0x73
Bit	7	6	5	4	3	2	1	0
Name	CFG_Receive_Data[7:0]							
Default	0	0	0	0	0	0	0	0
Access	R	R	R	R	R	R	R	R

CFG_Receive_Data[7:0] CFG Receive Data. This register holds the byte read from the Flash Memory (UFM/Configuration) logic. Bit 0 in this register is LSB.

Table 17-52. Flash Memory (UFM/Configuration) Interrupt Status

CFGIRQ								0x74
Bit	7	6	5	4	3	2	1	0
Name	(Reserved)		IRQTXFE	IRQTXFF	IRQRXFE	IRQRXFF	IRQSSPIACT	IRQI2CACT
Default	0	0	0	0	0	0	0	0
Access	—	—	R/W	R/W	R/W	R/W	R/W	R/W

IRQTXFE Interrupt Status for Transmit FIFO Empty. When enabled, indicates TXFE was asserted. Write a '1' to this bit to clear the interrupt.

- 1: Transmit FIFO Empty Interrupt
- 0: No interrupt

IRQTXFF Interrupt Status for Transmit FIFO Full. When enabled, indicates TXFF was asserted. Write a '1' to this bit to clear the interrupt.

- 1: Transmit FIFO Full Interrupt
- 0: No interrupt

IRQRXFE Interrupt Status for Receive FIFO Empty. When enabled, indicates RXFE was asserted. Write a '1' to this bit to clear the interrupt.

- 1: Receive FIFO Empty Interrupt
- 0: No interrupt

IRQRXFF Interrupt Status for Receive FIFO Full. When enabled, indicates RXFF was asserted. Write a '1' to this bit to clear the interrupt.

- 1: Receive FIFO Full Interrupt
- 0: No interrupt

- IRQSSPIACT** Interrupt Status for Slave SPI Active.
 When enabled, indicates SSPIACT was asserted. Write a '1' to this bit to clear the interrupt.
 1: Slave SPI Active Interrupt
 0: No interrupt
- IRQI2CACT** Interrupt Status for I²C Active.
 When enabled, indicates I2CACT was asserted. Write a '1' to this bit to clear the interrupt.
 1: I²C Active Interrupt
 0: No interrupt

Table 17-53. Flash Memory (UFM/Configuration) Interrupt Enable

CFGIRQEN								0x75
Bit	7	6	5	4	3	2	1	0
Name	(Reserved)		IRQTXFEEN	IRQTXFFEN	IRQRXFEEN	IRQRXFFEN	IRQSSPIACTEN	IRQI2CACTEN
Default	0	0	0	0	0	0	0	0
Access	—	—	R/W	R/W	R/W	R/W	R/W	R/W

- IRQTXFEEN** Interrupt Enable for Transmit FIFO Empty
 1: Interrupt generation enabled
 0: Interrupt generation disabled
- IRQTXFFEN** Interrupt Enable for Transmit FIFO Full
 1: Interrupt generation enabled
 0: Interrupt generation disabled
- IRQRXFEEN** Interrupt Enable for Receive FIFO Empty
 1: Interrupt generation enabled
 0: Interrupt generation disabled
- IRQRXFFEN** Interrupt Enable for Receive FIFO Full
 1: Interrupt generation enabled
 0: Interrupt generation disabled
- IRQSSPIACTEN** Interrupt Enable for Slave SPI Active
 1: Interrupt generation enabled
 0: Interrupt generation disabled
- IRQI2CACTEN** Interrupt Enable for I²C Active
 1: Interrupt generation enabled
 0: Interrupt generation disabled

Table 17-54. Unused (Reserved) Register

UNUSED								0x76
Bit	7	6	5	4	3	2	1	0
Name	(Reserved)							
Default	0	0	0	0	0	0	0	0
Access	—	—	—	—	—	—	—	—

Table 17-55. EFB Interrupt Source

EFBIRQ								0x77
Bit	7	6	5	4	3	2	1	0
Name	(Reserved)			UFMCFG_INT	TC_INT	SPI_INT	I2C2_INT	I2C1_INT
Default	0	0	0	0	0	0	0	0
Access	R	R	R	R	R	R	R	R

- UFMCFG_INT** Flash Memory (UFM/Configuration) Interrupt Source. Indicates EFB interrupt source is from the UFM/Configuration Block. Use CFGIRQ for further source resolution.
 1: A bit is set in register CFGIRQ
 0: No interrupt
- TC_INT** Timer/Counter Interrupt Source. Indicates EFB interrupt source is from the Timer/Counter Block. Use TCIRQ for further source resolution.
 1: A bit is set in register TCIRQ
 0: No interrupt
- SPI_INT** SPI Interrupt Source. Indicates EFB interrupt source is from the SPI Block. Use SPI-IRQ for further source resolution.
 1: A bit is set in register SPIIRQ
 0: No interrupt
- I2C2_INT** I2C2 Interrupt Source. Indicates EFB interrupt source is from the Secondary I²C Block. Use I2C_2_ IRQ for further source resolution.
 1: A bit is set in register I2C_2_ IRQ
 0: No interrupt
- I2C1_INT** I2C1 Interrupt Source. Indicates EFB interrupt source is from the Primary I²C Block. Use I2C_1_ IRQ for further source resolution.
 1: A bit is set in register I2C_1_ IRQ
 0: No interrupt

Command and Data Transfers to Flash Memory (UFM/Configuration) Space

The command and data transfers to the Flash Memory (UFM/Configuration) are identical for all the access ports, regardless of their different physical interfaces. The Flash Memory (UFM/Configuration) is organized in pages. Therefore, users address a specific page for Read or Write operations to that page. Each page has 128 bits (16 bytes). The transfers are based on a set of instructions and page addresses. The Flash memory is composed of two sectors, Configuration Memory (sector 0) and UFM (sector 1). The Erase operations are sector based.

Command Summary by Application

Table 17-56. UFM (Sector 1) Commands

Command Name	Command MSB LSB	SVF Command Name	Description
Read Status Register	0x3C	LSC_READ_STATUS	Read the 4-byte Configuration Status Register
Check Busy Flag	0xF0	LSC_CHECK_BUSY	Read the Configuration Busy Flag status
Bypass	0xFF	ISC_NOOP	Null operation.
Enable Configuration Interface (Transparent Mode)	0x74	ISC_ENABLE_X	Enable Transparent UFM access – All user I/Os (except the hardened user SPI and primary user I ² C ports) are governed by the user logic, the device remains in User mode. (The subsequent commands in this table require the interface to be enabled.)
Enable Configuration Interface (Offline Mode)	0xC6	ISC_ENABLE	Enable Offline UFM access – All user I/Os (except persisted sysCONFIG ports) are tri-stated. User logic ceases to function, UFM remains accessible, and the device enters 'Offline' access mode. (The subsequent commands in this table require the interface to be enabled.)
Disable Configuration Interface	0x26	ISC_DISABLE	Disable the configuration (UFM) access.
Set Address	0xB4	LSC_WRITE_ADDRESS	Set the UFM sector 14-bit Address Register
Reset UFM Address	0x47	LSC_INIT_ADDR_UFM	Reset the address to point to Sector 1, Page 0 of the UFM.
Read UFM	0xCA	LSC_READ_TAG	Read the UFM data. Operand specifies number pages to read. Address Register is post-incremented.
Erase UFM	0xCB	LSC_ERASE_TAG	Erase the UFM sector only.
Program UFM Page	0xC9	LSC_PROG_TAG	Write one page of data to the UFM. Address Register is post-incremented.

Table 17-57. Configuration Flash (Sector 0) Commands

Command Name	Command MSB LSB	SVF Command Name	Description
Read Device ID	0xE0	IDCODE_PUB	Read the 4-byte Device ID (0x01 2b 20 43)
Read USERCODE	0xC0	USERCODE	Read 32-bit USERCODE
Read Status Register	0x3C	LSC_READ_STATUS	Read the 4-byte Configuration Status Register
Read Busy Flag	0xF0	LSC_CHECK_BUSY	Read the Configuration Busy Flag status
Refresh ¹	0x79	LSC_REFRESH	Launch boot sequence (same as toggling PROGRAMN pin).
STANDBY	0x7D	LSC_DEVICE_CTRL	Triggers the Power Controller to enter or wake from standby mode
Bypass	0xFF	ISC_NOOP	Null operation.
Enable Configuration Interface (Transparent Mode)	0x74	ISC_ENABLE_X	Enable Transparent Configuration Flash access – All user I/Os (except the hardened user SPI and primary user I ² C ports) are governed by the user logic, the device remains in User mode. (The subsequent commands in this table require the interface to be enabled.)

Table 17-57. Configuration Flash (Sector 0) Commands (Continued)

Command Name	Command MSB LSB	SVF Command Name	Description
Enable Configuration Interface (Offline Mode)	0xC6	ISC_ENABLE	Enable Offline Configuration Flash access – All user I/Os (except persisted sysCONFIG ports) are tri-stated. User logic ceases to function, UFM remains accessible, and the device enters 'Offline' access mode. (The subsequent commands in this table require the interface to be enabled.)
Disable Configuration Interface	0x26	ISC_DISABLE	Exit access mode.
Set Configuration Flash Address	0xB4	LSC_WRITE_ADDRESS	Set the Configuration Flash 14-bit Page Address
Verify Device ID	0xE2	VERIFY_ID	Verify device ID with 32-bit input, set Fail flag if mismatched.
Reset Configuration Flash Address	0x46	LSC_INIT_ADDRESS	Reset the address to point to Sector 0, Page 0 of the Configuration Flash.
Read Flash	0x73	LSC_READ_INCR_NV	Read the Flash data. Operand specifies number pages to read. Address Register is post-incremented.
Erase	0x0E	ISC_ERASE	Erase the Config Flash, Done bit, Security bits and USERCODE
Program Page	0x70	LSC_PROG_INCR_NV	Write 1 page of data to the Flash Memory (Configuration/UFM). Address Register is post-incremented.
Program DONE	0x5E	ISC_PROGRAM_DONE	Program the Done bit
Program SECURITY	0xCE	ISC_PROGRAM_SECURITY	Program the Security bit (Secures CFG Flash sector)
Program SECURITY PLUS	0xCF	ISC_PROGRAM_SECPLUS	Program the Security Plus bit (Secures CFG and UFM Sectors). Note: SECURITY and SECURITY PLUS commands are mutually exclusive.
Program USERCODE	0xC2	ISC_PROGRAM_USERCODE	Program 32-bit USERCODE
Read Feature Row	0xE7	LSC_READ_FEATURE	Read Feature Row
Program Feature Row	0xE4	LSC_PROG_FEATURE	Program Feature Row
Read FEABITS	0xFB	LSC_READ_FEABITS	Read FEA bits
Program FEABITS	0xF8	LSC_PROG_FEABITS	Program the FEA bits

1. The Refresh commands are not supported by the software simulation model.

Table 17-58. Non-Volatile Register (NVR) Commands

Command Name	Command msb lsb	SVF Command Name	Description
Read Trace ID code	0x19	UIDCODE_PUB	Read 64-bit TracelD.

When using the WISHBONE bus interface, the commands, operand and data are written to the CFGTXDR Register. The Slave SPI or I²C interface shift the most significant bit (MSB) first into the MachXO2 device. This is required only when communicating with the configuration logic inside the MachXO2 device.

In order to perform a Write, Read or Erase operation with the UFM or Configuration Flash, it is required that the interface is enabled using Command 0x74. Affected commands are noted in the Command Description as “EN Required.” Once the modification operations are completed, the interface can be disabled using commands 0x26 and 0xFF.

Command Descriptions by Command Code

Table 17-59. Erase Flash (0x0E)

UFM	CFG	NVR	EN Required	CMD (Hex)	Operands (Hex)	Data Mode	Data Size	Data Format
x	x		Y	0E	See below	—	—	—

Operand: 0000 ucfs 0000 0000 0000 0000(binary)

where:

- u: Erase UFM sector
 - 0: No action
 - 1: Erase
- c: Erase CFG sector (Config Flash, DONE, security bits, USERCODE)
 - 0: No action
 - 1: Erase
- f: Erase Feature sector (Slave I²C address, sysCONFIG port persistence, Boot mode, OTP, etc.)
 - 0: No action
 - 1: Erase
- s: Erase SRAM
 - 0: No action
 - 1: Erase

Notes: Poll the BUSY bit (or wait, see Table 17-97) after issuing this command for erasure to complete before issuing a subsequent command other than Read Status or Check Busy.

Erased condition for Flash bits = 0

Examples:

- 0x0E 04 00 00
Erase CFG sector
- 0x0E 08 00 00
Erase UFM sector
- 0x0E 0C 00 00
Erase UFM and CFG sectors

Table 17-60. Read TracelD Code (0x19)

UFM	CFG	NVR	EN Required	CMD (Hex)	Operands (Hex)	Data Mode	Data Size	Data Format
		x	N	19	00 00 00	R	8B	—

Example: 0x19 00 00 00
Read 8-byte TracelD

Note: First byte read is user portion. Next seven bytes are unique to each silicon die.

Table 17-61. Disable Configuration Interface (0x26)

UFM	CFG	NVR	EN Required	CMD (Hex)	Operands (Hex)	Data Mode	Data Size	Data Format
x	x		—	26	00 00	—	—	—

Example: 0x26 00 00
 Disable Flash Memory (UFM/configuration) interface for change access

Notes: Must have only two operands

The interface cannot be disabled while the Configuration Status Register Busy bit is asserted. After commands (e.g. Erase, Program) verify Busy is clear before issuing the Disable command.

This command should be followed by Command 0xFF (BYPASS) to complete the Disable operation. The BYPASS command is required to restore Power Controller, GSR, Hardened User SPI and I²C port operation.

SRAM must be erased before exiting Offline (0xC6) Mode

Table 17-62. Read Status Register (0x3C)

UFM	CFG	NVR	EN Required	CMD (Hex)	Operands (Hex)	Data Mode	Data Size	Data Format (Binary)
x	x		N	3C	00 00 00	R	4B	xxxx 1xEE Exxx xxxx xxFB xxCD xxxx xxxx

Data Format: Most significant byte of SR is received first, LSB last.

D bit 8 Flash or SRAM Done Flag
 When C = 0 SRAM Done bit has been programmed

- D = 1 Successful Flash to SRAM transfer
- D = 0 Failure in the Flash to SRAM transfer

When C=1 Flash Done bit has been programmed

- D = 1 Programmed
- D = 0 Not Programmed

C bit 9 Enable Configuration Interface (1=Enable, 0=Disable)

B bit 12: Busy Flag (1 = busy)

F bit 13: Fail Flag (1 = operation failed)

I I=0 Device verified correct, I=1 Device failed to verify

EEE bits[25:23]: Configuration Check Status

- 000: No Error
- 001: ID ERR
- 010: CMD ERR
- 011: CRC ERR
- 100: Preamble ERR
- 101: Abort ERR
- 110: Overflow ERR
- 111: SDM EOF

(all other bits reserved)

Usage: The BUSY bit should be checked following all Enable, Erase or Program operations.

Note: Wait at least 1us after power-up or asserting wb_rst_i before accessing the EFB.

Example: 0x3C 00 00 00
 Read 4-byte Status Register e.g. 0x00 00 20 00 (fail flag set)

Table 17-63. Reset CFG Address (0x46)

UFM	CFG	NVR	EN Required	CMD (Hex)	Operands (Hex)	Data Mode	Data Size	Data Format
	x		Y	46	00 00 00	—	—	—

Example: 0x46 00 00 00
Set Address register to Configuration Sector 0, page 0

Table 17-64. Reset UFM Address (0x47)

UFM	CFG	NVR	EN Required	CMD (Hex)	Operands (Hex)	Data Mode	Data Size	Data Format
x			Y	47	00 00 00	—	—	—

Example: 0x47 00 00 00
Set Address register to UFM Sector 1, page 0

Table 17-65. Program DONE (0x5E)

UFM	CFG	NVR	EN Required	CMD (Hex)	Operands (Hex)	Data Mode	Data Size	Data Format
	x		Y	5E	00 00 00	—	—	—

Example: 0x5E 00 00 00
Set the DONE bit

Note: Poll the BUSY bit (or wait 200us) after issuing this command for programming to complete before issuing a subsequent command other than Read Status or Check Busy.

Table 17-66. Program Configuration Flash (0x70)

UFM	CFG	NVR	EN Required	CMD (Hex)	Operands (Hex)	Data Mode	Data Size	Data Format
	x		Y	70	00 00 01	W	16B	16 bytes UFM write data

Example: 0x70 00 00 01 00 01 02 03 04 05 06 07 08 09 0A 0B 0C 0D 0E 0F

Write one page of data, pointed to by Address Register

Notes: 16 data bytes must be written following the command and operand bytes to ensure proper data alignment. The Address Register is auto-incremented following the page write.

Operands (0x00 00 00) are equivalent to (0x00 00 01).

Use 0x0E to erase CFG sector prior to executing this command.

Poll the BUSY bit (or wait 200us) after issuing this command for programming to complete before issuing a subsequent command other than Read Status or Check Busy.

Table 17-67. Read Configuration Flash (0x73) (WISHBONE/SPI)

UFM	CFG	NVR	EN Required	CMD (Hex)	Operands (Hex)	Data Mode	Data Size	Data Format
	x		Y	73	* (below)	R	** (below)	*** (below)

Note: This applies when Configuration Flash is read through WISHBONE or SPI

*Operand: 0001 0000 00pp pppp pppp pppp (binary)
 pp..pp: num_pages Number of CFG pages to read when num_pages = 1
 Number of CFG pages to read +1 when num_pages > 1

**Data Size: (num_pages * 16) bytes

Note: Read CFG may be aborted at any time. Any data remaining in the read FIFO will be discarded. Any read data beyond the prescribed read size will be indeterminate. The Address Register is auto-incremented after each page read.

***Examples: 0x73 10 00 01
 0 bytes dummy followed by one page of CFG data (16 bytes total)

0x73 10 00 04
 Read 1 page dummy followed by three pages of CFG data (four pages total)

Note: The maximum speed which one page of data (num_page=1) can be read through the WISHBONE is 36 MHz. There is no restriction on SPI speeds besides the port limitations.

Table 17-68. Read Configuration Flash (0x73) (I²C/WISHBONE/SPI)

UFM	CFG	NVR	EN Required	CMD (Hex)	Operands (Hex)	Data Mode	Data Size	Data Format
	x		Y	73	* (below)	R	** (below)	*** (below)

Note: This applies when Configuration Flash is read through I²C, WISHBONE or SPI

*Operand: 0000 0000 00pp pppp pppp pppp (binary)
 pp..pp: num_pages Number of CFG pages to read when num_pages = 1
 Number of CFG pages to read +1 when num_pages > 1

**Data Size: (num_pages * 16) bytes when num_pages=1
 32 bytes + (num_pages) * (16 + 4) bytes when num_pages>1

Note: Read CFG may be aborted at any time. Any data remaining in the read FIFO will be discarded. Any read data beyond the prescribed read size will be indeterminate. The Address Register is auto-incremented after each page read.

***Examples: 0x73 00 00 01
 0 bytes dummy followed by one page CFG data (16 bytes total)

0x73 00 00 04
 Read 2 pages dummy, followed by three sets [1 page CFG data, followed by four bytes dummy] (five pages and 12 dummy bytes total)

Note: The maximum speed which one page of data (num_page=1) can be read through the WISHBONE is 36 MHz. There is no restriction on I²C and SPI speeds besides the port limitations.

Table 17-69. Enable Configuration Interface (Transparent) (0x74)

UFM	CFG	NVR	EN Required	CMD (Hex)	Operands (Hex)	Data Mode	Data Size	Data Format
x	x		—	74	08 00 00 or 08 00	—	—	—

Notes:

The I²C interface uses only two operands all other interfaces use three operands. This command is required to enable modification of the UFM, configuration Flash, or non-volatile registers (NVR). Terminate this command with command 0x26 followed by command 0xFF.

Exercising this command will temporarily disable certain features of the device, notably GSR, user SPI port, primary user I²C port and Power Controller. These features are restored when the command is terminated.

Poll the BUSY bit (or wait 5us) after issuing this command for the Flash pumps to fully charge.

Example:

0x74 08 00 00
Enable UFM/configuration interface for change access through a non-I²C interface.

Table 17-70. Refresh (0x79)

UFM	CFG	NVR	EN Required	CMD (Hex)	Operands (Hex)	Data Mode	Data Size	Data Format (Binary)
				79	00 00	—	—	—

Example:

0x79 00 00
Issue Refresh command

Note:

The Refresh command will Launch Boot sequence

Must have only two operands

After completing the Refresh command (e.g. SPI SN deassertion or I²C stop), further bus accesses are prohibited for the duration of t_{REFRESH} . Violating this requirement will cause the Refresh process to abort and leave the MachXO2 device in an unprogrammed state.

Occasionally, following a device REFRESH or PROGRAMN pin toggle, the secondary I²C port may be left in an undefined (non-idle) state. The likely hood of this condition is design and route dependent. To positively return the Secondary I²C port to the idle state, write a value of 0x44 to register I2C_2_CMDR via WISHBONE immediately after device reset is released. This will cause a short low-pulse on SCK as the hard-block signals a STOP on the bus then returns to the idle state. Failure to manually return the Secondary I²C port to the idle state may result in an I²C bus lock-up condition. Normal I²C activity can be commenced without additional delay.

Table 17-71. STANDBY (0x7D)

UFM	CFG	NVR	EN Required	CMD (Hex)	Operands (Hex)	Data Mode	Data Size	Data Format (Binary)
	x		N	7D	0y 00	—	—	—

Example:

0x7D 0y 00

y:2 Triggers the Power Controller to enter standby mode

y:8 Triggers the Power Controller to wakeup from standby mode

Notes:

Must have only two operands.

The MachXO2 Power Controller needs to be included in the design.

Additionally the following can be used to trigger the Power Controller to wakeup from standby mode (if the user logic standby signal has not been enabled):

1. I²C has the following ways:
 - a. Primary I²C Configuration port – Address match to the I²C Configuration address (No other settings required)
 - b. Primary or Secondary I²C User port – Address match the I²C User address. Must have I2C_1_CR[WKUPEN] or I2C_1_CR[WKUPEN] set
 - c. General Call – Send the General Call Wakeup command (0xF3). Must have General Calls enabled (I2C_1_CR[GCEN] or I2C_2_CR[GCEN] set) and use the General Call address
2. SPI from the assertion of either Slave Configuration (ufm_sn) or User (spi_scsn) chip select, as long as the appropriate control register bit is set:
 - a. Configuration: SPICR1[WKUPEN_CFG]
 - b. User: SPICR[WKUPEN_USER]

For more information on the Power Controller refer to TN1198, [Power Estimation and Management for MachXO2 Devices](#).

Table 17-72. Set Address (0xB4)

UFM	CFG	NVR	EN Required	CMD (Hex)	Operands (Hex)	Data Mode	Data Size	Data Format (Binary)
x	x		Y	B4	00 00 00	W	4B	0s00 0000 0000 0000 00aa aaaa aaaa aaaa

Data Format:

s: sector
 0: Configuration
 1: UFM

aa..aa:address14-bit page address

Example:

0xB4 00 00 00 40 00 00 0A

Set Address register to UFM sector, page 10 decimal

Table 17-73. Read USERCODE (0xC0)

UFM	CFG	NVR	EN Required	CMD (Hex)	Operands (Hex)	Data Mode	Data Size	Data Format (Hex)
	x		Y/N	C0	00 00 00	R	4B	—

Example: 0xC0 00 00 00
 EN Required = Y Read 4-byte USERCODE from CFG sector
 EN Required = N Read 4-byte USERCODE from SRAM

Table 17-74. Program USERCODE (0xC2)

UFM	CFG	NVR	EN Required	CMD (Hex)	Operands (Hex)	Data Mode	Data Size	Data Format (Hex)
	x		Y	C2	00 00 00	W	4B	—

Example: 0xC2 00 00 00 10 20 30 40
 Sets USERCODE with 32-bit input 0x10 20 30 40

Note: Poll the BUSY bit (or wait 200us) after issuing this command for programming to complete before issuing a subsequent command other than Read Status or Check Busy.

Table 17-75. Enable Configuration Interface (Offline) (0xC6)

UFM	CFG	NVR	EN Required	CMD (Hex)	Operands (Hex)	Data Mode	Data Size	Data Format
	x			C6	0y 00 00	—	—	—

Operand: 08 00 00 - Enable Flash Normal mode. Normal edit mode for Offline configuration. Used for all offline commands described in this document, including Erase SRAM.

 00 00 00 - Enable SRAM mode. Optional edit mode. Supports Erase SRAM command only.

Example: 0xC6 08 00 00 Enable Flash Memory (UFM/configuration) interface for offline change access.

Notes: Use this command to enable offline modification of the UFM, Configuration Flash, or non-volatile registers (NVR). SRAM must be erased exiting Offline mode. When exiting Offline mode follow the command 0x26 with the command 0xFF. Exercising this command will tri-state all user I/Os (except persisted sysCONFIG ports). User logic ceases to function. UFM remains accessible.

 Poll the BUSY bit (or wait 5us) after issuing this command for the Flash pumps to fully charge.

Table 17-80. Program SECURITY (0xCE)

UFM	CFG	NVR	EN Required	CMD (Hex)	Operands (Hex)	Data Mode	Data Size	Data Format
	x		Y	CE	00 00 00	—	—	—

Example: 0xCE 00 00 00

Set the SECURITY bit

Note: Poll the BUSY bit (or wait 200us) after issuing this command for programming to complete before issuing a subsequent command other than Read Status or Check Busy.

SECURITY and SECURITY PLUS commands are mutually exclusive.

Table 17-81. Program SECURITY PLUS (0xCF)

UFM	CFG	NVR	EN Required	CMD (Hex)	Operands (Hex)	Data Mode	Data Size	Data Format
	x		Y	CF	00 00 00	—	—	—

Example: 0xCF 00 00 00

Set the SECURITY PLUS bit

Note: Poll the BUSY bit (or wait 200us) after issuing this command for programming to complete before issuing a subsequent command other than Read Status or Check Busy.

SECURITY and SECURITY PLUS commands are mutually exclusive.

Table 17-82. Read Device ID Code (0xE0)

UFM	CFG	NVR	EN Required	CMD (Hex)	Operands (Hex)	Data Mode	Data Size	Data Format (Hex)
	x		N	E0	00 00 00	R	4B	See Table 17-83

Example: 0xE0 00 00 00

Read 4-byte device ID

Table 17-83. Device ID Table

Device Name	HE/ZE Devices	HC Devices
MachXO2-256	0x01 2B 00 43	0x01 2B 80 43
MachXO2-640	0x01 2B 10 43	0x01 2B 90 43
MachXO2-1200/MachXO2-640U	0x01 2B 20 43	0x01 2B A0 43
MachXO2-2000/MachXO2-1200U	0x01 2B 30 43	0x01 2B B0 43
MachXO2-4000/MachXO2-2000U	0x01 2B 40 43	0x01 2B C0 43
MachXO2-7000	0x01 2B 50 43	0x01 2B D0 43

Example: 0xE0 00 00 00

Read 4-byte device ID

Table 17-84. Verify Device ID Code (0xE2)

UFM	CFG	NVR	EN Required	CMD (Hex)	Operands (Hex)	Data Mode	Data Size	Data Format (Hex)
	x		Y	E2	00 00 00	W	4B	See Table 17-83

Example: 0xE2 00 00 00 01 2B 20 43
 Verify device ID with 32-bit input, sets ID Error bit 27 in SR if mismatched

Table 17-85. Program Feature Row (0xE4)

UFM	CFG	NVR	EN Required	CMD (Hex)	Operands (Hex)	Data Mode	Data Size	Data Format (Hex)
			Y	E4	00 00 00		8B	00 00 ss uu cc cc cc cc

Data Format: ss: 8 bits for the user programmable I²C Slave Address
 uu: 8 bits for the user programmable TraceID
 cc cc cc cc: 32 bits of Custom ID code

Note: It is not recommended to reprogram the Feature Row once it has been program the first time.

Example: 0xE4 00 00 00 00 00 01 00 00 00 12 34
 Program Feature Row with User I²C address set to 1, default user TraceID string, Custom ID code of 12 34

Table 17-86. Read Feature Row (0xE7)

UFM	CFG	NVR	EN Required	CMD (Hex)	Operands (Hex)	Data Mode	Data Size	Data Format (Hex)
		x	Y	E7	00 00 00	R	8B	00 00 ss uu cc cc cc cc

Data Format: ss: 8 bits for the user programmable I²C Slave Address
 uu: 8 bits for the user programmable TraceID
 cc cc cc cc: 32 bits of Custom ID code

Example: 0xE7 00 00 00
 Reads the Feature Row

Table 17-87. Check Busy Flag (0xF0)

UFM	CFG	NVR	EN Required	CMD (Hex)	Operands (Hex)	Data Mode	Data Size	Data Format (Binary)
x	x		N	F0	00 00 00	R	1B	Bxxx xxxx

Data Format: B: bit 7: Busy Flag (1= busy)
 (all other bits reserved)

Example: 0xF0 00 00 00
 Read one byte, e.g. 0x80 (busy flag set)

Table 17-88. Program FEABITs (0xF8)

UFM	CFG	NVR	EN Required	CMD (Hex)	Operands (Hex)	Data Mode	Data Size	Data Format (Binary)
		x	Y	F8	00 00 00	W	2B	00 bb mi sj di pa 00 00

Data Format:

- bb: Boot Sequence
 1. If b=00 (Default) and m=0 then Single Boot from Configuration Flash
 2. If b=00 and m=1 then Dual Boot from Configuration Flash then External if there is a failure
 3. If b=01 and m=1 then Single Boot from External Flash
- m: Master SPI Port Persistence
0=Disabled (Default), 1=Enabled
- i: I²C Port Persistence
0=Enabled (Default), 1=Disabled
- s: Slave SPI Port Persistence
0=Enabled (Default), 1=Disabled
- j: JTAG Port Persistence
0=Enabled (Default), 1=Disabled
- d: DONE Persistence
0=Disabled (Default), 1=Enabled
- i: INITN Persistence
0=Disabled (Default), 1=Enabled
- p: PROGRAMN Persistence
0=Enabled (Default), 1=Disabled
- a: my_ASSP Enabled
0=Disabled (Default), 1=Enabled

Note: It is not recommended to reprogram the FEABITs once they have been programmed the first time.

Example: 0xF8 00 00 00 0D 20
Programs the FEABITs

Table 17-89. Read FEABITs (0xFB)

UFM	CFG	NVR	EN Required	CMD (Hex)	Operands (Hex)	Data Mode	Data Size	Data Format (Binary)
		x	Y	FB	00 00 00	R	2B	00 bb mi sj di pa 00 00

Data Format:

- bb: Boot Sequence
 1. If b=00 (Default) and m=0 then Single Boot from Configuration Flash
 2. If b=00 and m=1 then Dual Boot from Configuration Flash then External if there is a failure
 3. If b=01 and m=1 then Single Boot from External Flash
- m: Master SPI Port Persistence
0=Disabled (Default), 1=Enabled
- i: I²C Port Persistence
0=Enabled (Default), 1=Disabled
- s: Slave SPI Port Persistence
0=Enabled (Default), 1=Disabled
- j: JTAG Port Persistence
0=Enabled (Default), 1=Disabled
- d: DONE Persistence
0=Disabled (Default), 1=Enabled
- i: INITN Persistence
0=Disabled (Default), 1=Enabled
- p: PROGRAMN Persistence
0=Enabled (Default), 1=Disabled
- a: my_ASSP Enabled
0=Disabled (Default), 1=Enabled

Table 17-90. Bypass (Null Operation) (0xFF)

UFM	CFG	NVR	EN Required	CMD (Hex)	Operands (Hex)	Data Mode	Data Size	Data Format (Binary)
x	x	x	N	FF	FF FF FF	—	—	—

Note: Operands are optional

Example: 0xFF FF FF FF Bypass

Interface to Configuration Flash

The WISHBONE interface of the EFB module allows a WISHBONE host to access the configuration resources of the MachXO2 devices. This can be particularly useful for reading data from configuration resources such as USERCODE and TraceID. Most importantly, this feature allows users to update the Configuration Flash array of the devices while the device is in operation mode. This is a self-configuration operation. Upon power-up or a configuration refresh operation, the new content of the Configuration Flash is loaded into the Configuration SRAM and the device continues operation with a new configuration.

The data transfer and execution of operations is the same as the one documented in the UFM section of this document. This is due to the fact that the UFM is also a Flash Memory resource and the communication between the WISHBONE host and the configuration logic is performed through the same command, status and data registers. Please see Tables 17-48 to 17-93 for information on these registers.

Figure 17-31 shows a basic flow diagram for implementing a Configuration Flash Update initiated via any of the sysCONFIG ports (I²C, SPI, or WISHBONE).

For detailed information on MachXO2 programming and configuration, see TN1204, [MachXO2 Programming and Configuration Usage Guide](#).

Figure 17-31. Basic Configuration Flash Update Example

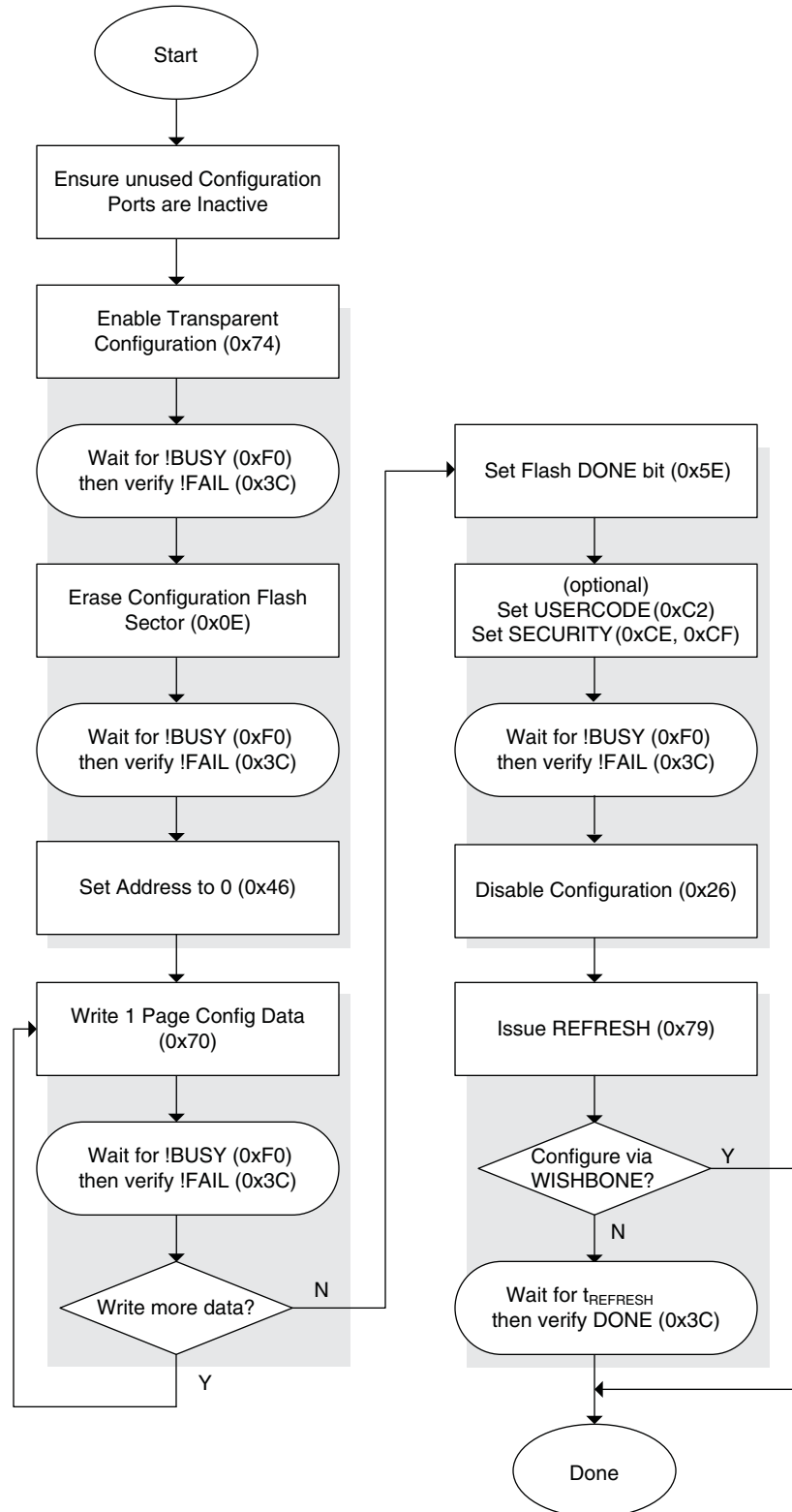

Command Framing

I²C Framing

Each command string sent to the I²C EFB port must be correctly “framed” using the protocol defined for each interface. In the case of I²C, the protocol is well known and defined by the industry as shown below.

Table 17-91. Command Framing Protocol, by Interface

Interface	Pre-op (+)	Command String	Post-op (-)
I ² C	Start	(Command/Operands/Data)	Stop

Figure 17-32. I²C Read Device ID Example

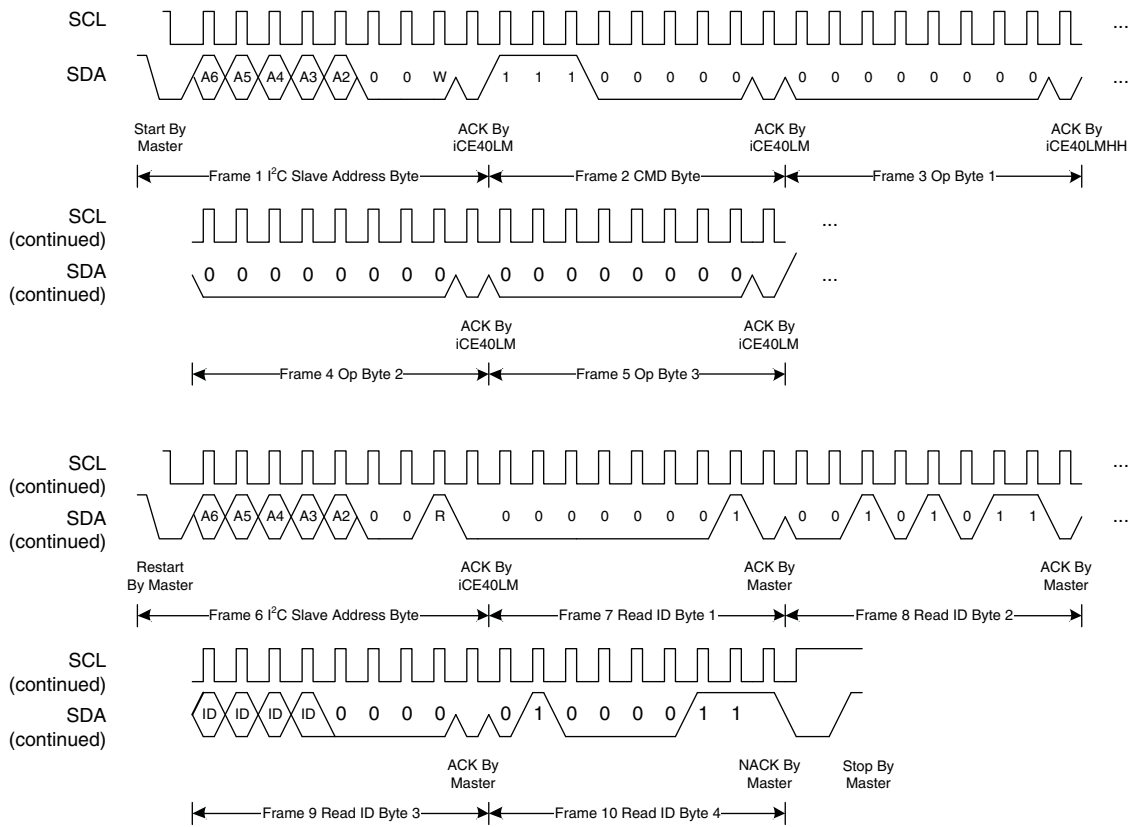

SPI Framing

Each command string sent to the SPI EFB port must be correctly 'framed' using the protocol defined for each interface. In the case of SSPI the protocol is well known and defined by the industry as shown below:

Table 17-92. Command Framing Protocol, by Interface

Interface	Pre-op (+)	Command String	Post-op (-)
SPI	Assert CS	(Command/Operands/Data)	De-assert CS

Figure 17-33. SSPI Read Device ID Example

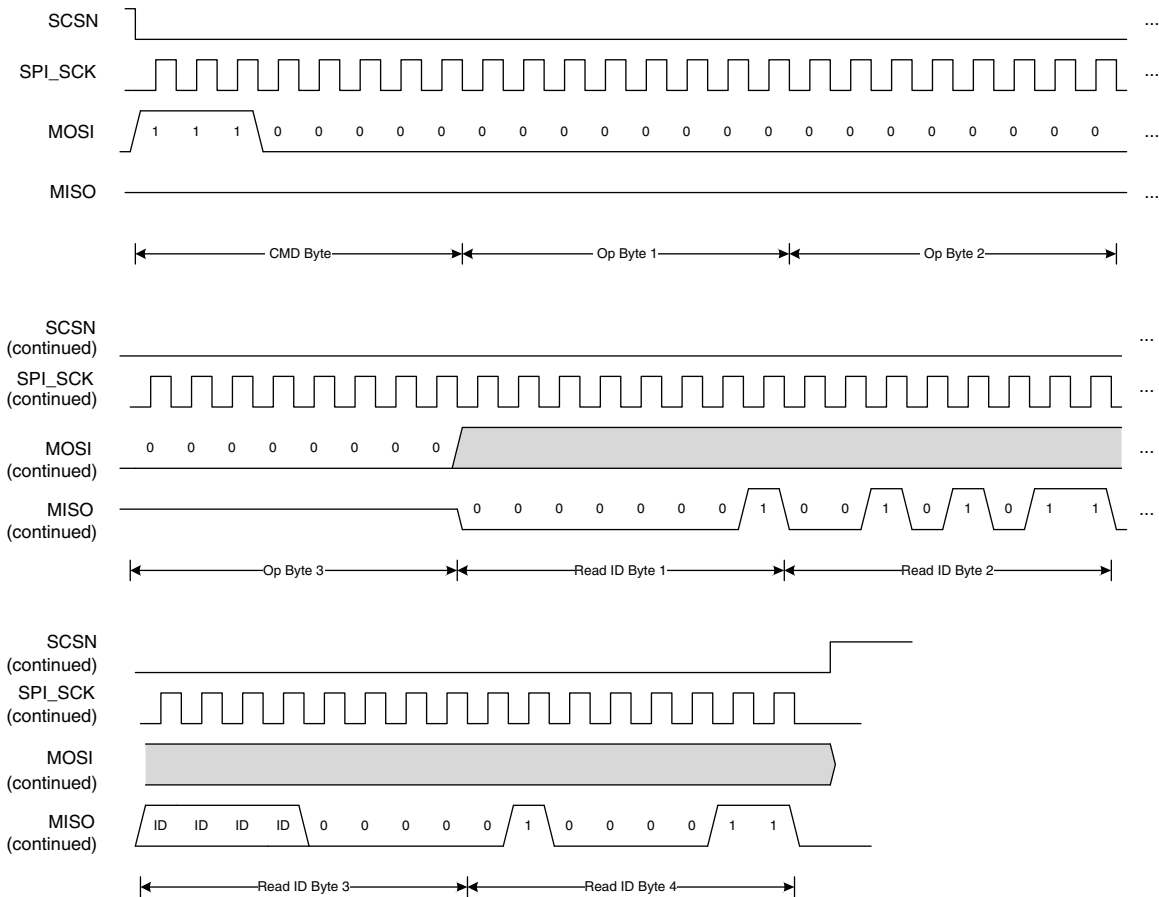

WISHBONE Framing

To access the Flash Memory (UFM/Configuration) each command string sent to the WISHBONE EFB ports must be correctly ‘framed’ using the protocol defined for each interface. In the case of the internal WISHBONE port, each command string is preceded by setting CFGCR[WBCE]. Similarly, each command string is followed by clearing the CFGCR[WBCE] bit.

Table 17-93. Command Framing Protocol, by Interface

Interface	Pre-op (+)	Command String	Post-op (-)
WISHBONE	Assert CFGCR[WBCE]	(Command/Operands/Data)	De-assert CFGCR[WBCE]

Figure 17-34. WISHBONE Read Device ID Example (-1200 HC Device)

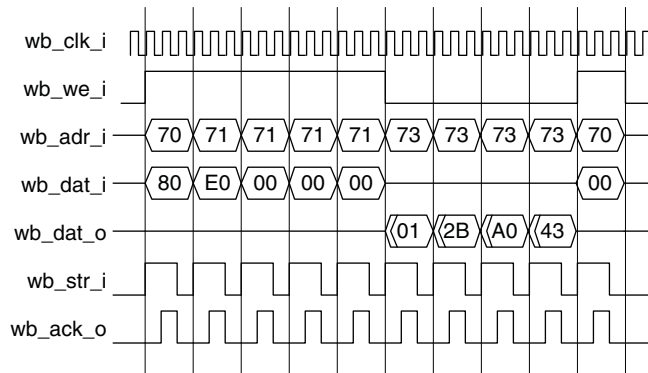

UFM Write and Read Examples

The UFM and Configuration sectors support page-oriented read and write operations while erase operations are sector-based. Consistent with many Flash memory devices, byte-oriented operations are not supported. Also, as typical with Flash memory devices, attempting to modify a previously written location in Flash requires a read-modify-write operation on the smallest erasable Flash unit. In the case of MachXO2, the smallest erasable unit is the entire UFM sector or the entire Configuration Sector.

For example, to arbitrarily modify a byte value in the UFM, the user must:

1. Read and save all UFM data to an alternate location (e.g. EBR);
2. Erase the UFM sector;
3. Modify the selected byte; and
4. Program the UFM page by page.

In some applications it may be appropriate to keep a working copy of the UFM contents in volatile Embedded Block RAM and update the non-volatile UFM at appropriate intervals. The following examples show the sequence of commands for writing and reading from UFM.

Table 17-94. Write Two UFM Pages

Instruction Number	R/W1	CMD2	Operand	Data	Comment
		+			Open frame
1	W	74	08 00 00	—	Enable Configuration Interface
		-			Close frame
		+			
2	W	3C	00 00 00	—	Poll Configuration Status Register

Table 17-94. Write Two UFM Pages (Continued)

Instruction Number	R/W1	CMD2	Operand	Data	Comment
	R			xx xx bx xx	
		-			(Repeat until Busy Flag not set, or wait 5us if not polling)
		+			
3	W	47	00 00 00	—	Init UFM Address to 0000
		-			
		+			
4	W	C9	00 00 01	00 01 02 03 04 05 06 07 08 09 0A 0B 0C 0D 0E 0F	Write UFM Page 0 Data
		-			
		+			
5	W	3C	00 00 00	—	Poll Configuration Status Register
	R			xx xx bx xx	
		-			(repeat until Busy Flag not set, or wait 200us if not polling)
		+			
6	W	C9	00 00 01	10 11 12 13 14 15 16 17 18 19 1A 1B 1C 1D 1E 1F	Write UFM Page 1 Data (Note: Address automatically incremented)
		-			
		+			
7	W	3C	00 00 00	—	Poll Configuration Status Register
	R			xx xx bx xx	
		-			(poll until Busy Flag clear, or wait 200us if not polling)
		+			
8	W	26	00 00	—	Disable Configuration Interface
		-			
		+			
9	W	FF	—	—	Bypass (NOP)
		-			

1. When accessing UFM/Configuration Flash via WISHBONE use CFGTXDR (0x71) to write data and CFDRXDR (0x73) to read data.
2. '+' and '-' refer to the command framing protocol appropriate for the interface, discussed in ["Command Framing"](#) on page 69.

Table 17-95. Read One UFM Page (All Devices, WISHBONE/SPI)

Instruction Number	R/W1	CMD2	Operand	Data	Comment
		+			Open frame
1	W	74	08 00 00	—	Enable Configuration Interface
		-			Close frame
		+			
2	W	3C	00 00 00	—	Poll Configuration Status Register
	R			xx xx bx xx	
		-			(Repeat until Busy Flag not set, or wait 5us if not polling)
		+			
3	W	B4	00 00 00	40 00 00 01	Set UFM Address to 0001
		-			
		+			
4	W	CA	10 00 01		Read one page UFM (page 1) data
	R			10 11 12 13 14 15 16 17 18 19 1A 1B 1C 1D 1E 1F	
		-			
		+			
5	W	26	00 00	—	Disable Configuration Interface
		-			
		+			
6	W	FF	—	—	Bypass (NOP)
		-			

1. When accessing UFM/Configuration Flash via WISHBONE use CFGTXDR (0x71) to write data and CFDRXDR (0x73) to read data.
2. '+' and '-' refer to the command framing protocol appropriate for the interface, discussed in ["Command Framing" on page 69](#).

Table 17-96. Read Two UFM Pages (WISHBONE/SPI)

Instruction Number	R/W1	CMD2	Operand	Data	Comment
		+			Open frame
1	W	74	08 00 00	—	Enable Configuration Interface
		-			Close frame
		+			
2	W	3C	00 00 00	—	Poll Configuration Status Register
	R			xx xx bx xx	
		-			(Repeat until Busy Flag not set, or wait 5us if not polling)
		+			
3	W	47	00 00 00	—	Init UFM address to 0000
		-			
		+			
4	W	CA	10 00 03		Read two pages of UFM data, after one page of dummy bytes. ³
	R			xx xx xx xx xx xx xx xx xx xx xx xx xx xx xx xx 00 01 02 03 04 05 06 07 08 09 0A 0B 0C 0D 0E 0F 10 11 12 13 14 15 16 17 18 19 1A 1B 1C 1D 1E 1F	
		-			
		+			
5	W	26	00 00	—	Disable Configuration Interface
		-			
		+			
6	W	FF	—	—	Bypass (NOP)
		-			

1. When accessing UFM/Configuration Flash via WISHBONE use CFGTXDR (0x71) to write data and CFDRXDR (0x73) to read data.
2. '+' and '-' refer to the command framing protocol appropriate for the interface
3. num_pages count must include dummy page.

Flash Memory Erase and Program Performance

Table 17-97. Flash Memory (UFM/Configuration) Performance in MachXO2 Devices¹

		MachXO2 -256	MachXO2 -640	MachXO2 -640U	MachXO2 -1200	MachXO2 -1200U	MachXO2 -2000	MachXO2 -2000U	MachXO2 -4000	MachXO2 -7000
CFG Erase (tEraseCFG)	Min.	400	600	800	800	1100	1100	1800	1800	2800
	Max.	700	1100	1400	1400	1900	1900	3100	3100	4800
CFG Program (tProgramCFG)	All	130	270	500	500	740	740	1400	1400	2200
	1 page	0.2	0.2	0.2	0.2	0.2	0.2	0.2	0.2	0.2
UFM Erase (tEraseUFM)	Min.	—	300	400	400	500	500	600	600	900
	Max.	—	600	700	700	900	900	1000	1000	1600
UFM Program (tProgramUFM)	All	—	40	110	110	140	140	180	180	480
	1 page	—	0.2	0.2	0.2	0.2	0.2	0.2	0.2	0.2

1. All times are averages, in (ms). SRAM erase times are < 0.1ms.

Erase/Program/Verify Time Calculation Example

Using the data above, it is possible to roughly calculate the time required to perform an Erase/Program/Verify operation. The calculation assumes nearly 100% bus utilization. Overhead required by bus master processes, if any, is not accounted for in the equation below.

E/P/V time (us): $t_{EraseProgramVerify} = t_{Erase} + t_{Program} + t_{Verify}$

where:

$$t_{Erase} = t_{EraseCFG} + t_{EraseUFM}^1$$

$$t_{Program} = 0.2us * \text{number of Pages to program}^2$$

$$t_{Verify} = (8 * \text{number of Pages programmed}) * BusEff * t_{BUSCLK}$$

Table 17-98. E/P/V Calculation parameters

	BusEff (Single Page Read)	BusEff ³ (Multi Page Read)	tBUSCLK
I ² C	14	>12	2.5us min
SPI	12	> 8	0.015us min
WB	5.25	> 3	0.020us min

1. Sector erase times are additive. If a sector (e.g. CFG) is not erased, its erase time is 0.
2. Data transfer time is insignificant to tProgram for high-speed data protocols. To account for slow bus speeds (E.g. I²C) multiply tVerify by 2.
3. Bus efficiency approaches this value as number of read pages increases.

Technical Support Assistance

e-mail: techsupport@latticesemi.com

Internet: www.latticesemi.com

Revision History

Date	Version	Change Summary
June 2012	01.0	Initial release.
August 2012	01.1	Timer/Counter Control 1 table – Corrected names of four LSBs.
		Program Feature Row (0xE4) table – Updated Data Size and Data Format (Hex) columns and text below table for ss, uu and cc cc cc cc. Added example.
		Read Feature Row (0xE7) table – Updated CMD (Hex) column.
		Read FEABITs (0xFB) table – Removed example below table.
		Read USERCODE (0xC0) table – Data Size column updated. EN Required” value changed from “N” to “Y/N” and example text updated.
		Updated Timer/Counter Control 0 table and Timer/Counter Control 1 table.
		Updated Basic Configuration Flash Update Example diagram.
		Device ID Table – Updated Device Name column.
		Read Status Register (0x3C) table – Updated Data Format column.
		Verify Device ID Code (0xE2) table – “EN Required” value changed from “N” to “Y” and example text updated.
October 2012	01.2	Added restriction: Primary port can be used as Configuration/UFM port or as a user port, but not both.
		Added restriction: Primary I ² C port is unavailable while in ISC_ENABLE_X (transparent) configuration access mode.
April 2013	01.3	Read Configuration Flash (0x73) (I ² C/WISHBONE/SPI) table – Corrected table title.
		Read Feature Row (0xE7) table – Updated Data Format in the table and description.
		Updated information in the I ² C Master Read/Write Example (via WISHBONE) figure.
		Updated examples in the Read UFM (0xCA) (WISHBONE/SPI/I ² C) table.
		Added note: SECURITY and SECURITY PLUS commands are mutually exclusive.
		Added Erase/Program/Verify time calculation example.
		Updated (decreased) the maximum WISHBONE clock rate for page reads from 36MHz to 16.6MHz.
		Corrected BUSY wait times (1000ns -> 200ns) in Write Two UFM Pages table.
		Updated Basic Configuration Flash Update Example, changed "Wait for !BUSY" to "Wait for tREFRESH" in last step.
		Added Wait for tREFRESH caution to Refresh command description.
Clarified Secondary I ² C non-idle reset issue after REFRESH.		

Date	Version	Change Summary
September 2013	01.4	Updated CPOL definition in the SPI Registers section. Changed SCK idle state from low to high.
		Updated SPI Control Timing figures in the SPI Timing Diagrams section.
		Corrected 0xCA num_pages and Data Size.
		Removed I ² C Clock-Stretching feature per PCN #10A-13.
		Updated the following figures: <ul style="list-style-type: none"> • I²C Master Read/Write Example (via WISHBONE) • I²C Slave Read/Write Example (via WISHBONE) • EFB Master – I²C Write • EFB Master – I²C Read
		Corrected I ² C General Call Data Register (Primary/Secondary) table number.
		Updated Technical Support Assistance information
December 2013	01.5	Updated Figure 17-2 .
		Added Typical I²C Transactions section.
		Added and reorganized Command Framing section.
		Moved I²C Framing section under Command Framing section.
		Added Figure 17-18 .
		Added Typical SPI Transactions section.
		Moved SPI Framing section under Command Framing section.
		Changed Operands (Hex) value in Table 17-75 and added description.
		Moved WISHBONE Framing section under Command Framing section.
		Moved Flash Memory Erase and Program Performance and Erase/Program/Verify Time Calculation Example sections after UFM Write and Read Examples section.
		Changed CPOL = 1 description in SPI Registers section.
		Updated Figure 17-23 . Changed second instance of SPISR[TRDY] to SPISR[ROE].
		Updated Figure 17-24 .
January 2014	01.6	Updated Figure 17-2 .
		Updated Figure 17-4 .
		Updated Figure 17-5 .
		Updated Figure 17-26 .
		Corrected version 01.5 Revision History.
	01.7	Updated Table 17-69 , Enable Configuration Interface (Transparent) (0x74). Changed Operands (Hex) data and added information to Notes and Example sections.
		Updated Table 17-97 , Flash Memory (UFM/Configuration) Performance in MachXO2 Devices.
		Updated Erase/Program/Verify equation in Erase/Program/Verify Time Calculation Example section.

Date	Version	Change Summary
February 2014	01.8	Updated Table 17-68 , Read Configuration Flash (0x73) (I2C/WISH-BONE/SPI). Revised Data Size formatting when num_pages>1.
June 2014	1.9	Updated the following figures: Figure 17-24 , SPI Control Timing (SPICR2[CPHA]=0, SPICR1[TXEDGE]=0) Figure 17-25 , SPI Control Timing (SPICR2[CPHA]=1, SPICR1[TXEDGE]=0) Figure 17-26 , SPI Control Timing (SPICR2[CPHA]=0, SPICR1[TXEDGE]=1) Figure 17-27 , SPI Control Timing (SPICR2[CPHA]=1, SPICR1[TXEDGE]=1).