

TO.system elektronik GmbH

SPECIFICATIONS

Type:NTM164M21
(Type Of TOSHIBA:TLX-1013-E0)

Approval Signature

--

NIPPON SHEET GLASS

APPR.	CHECK

NANOX CO.

APPR.	CHECK	DRAWING

NIPPON SHEET GLASS CO.,LTD
DISPLAY DEVICE GROUP
15-21,1-CHOME,SHIMOMARUKO
OHTAKU,TOKYO 146-0092 JAPAN
TEL:03-5482-3631
FAX:03-5482-3588
(MANUFACTURE:NANOX CORP.)

ISSUED DATE

--

1. General specifications

Items	Contents
dimensional out line	129.0 × 104.5 [mm]
active area	95.96 × 76.76 [mm]
viewing area	101.0 × 82.0 [mm]
display contents [pixels]	160 (W) × 128 (H)
dote size	0.56 × 0.56 [mm]
dote pitch	0.60 × 0.60 [mm]
display mode	Viewing direction 6 o'clock, STN Gray mode ,positive type
circuit	X-driver,Y-driver,Pover supply circuit, LCD controller (T6963C) ,RAM (8k bytes)
interface	\overline{CE} , \overline{WR} , \overline{RD} , $\overline{C/D}$, \overline{RESET} , Data (D0 ~ D7)

2. Absolute maximum ratings

Item	symbol	Absolute maximum ratings		unit	note
		min	max		
supply voltage	V _{DD}	0	7.0	V	-
	V _{DD} -V _{EE}	0	24.0		-
EL Driving Frequency	f _{EL}	50	1000	Hz	-
input voltage	V _{IN}	-0.3	V _{DD} -0.3	V	-
storage temperature	T _{op}	-20	60	°C	-
operating temperature	T _{stg}	0	50		-
humidity	-	10	90	%RH	※

※ wet bulb temperature should be 29 °C max.,and no condensation of water .

3. Electrical specifications

(Conditions: Ta=25 °C)

Item	symbol	conditions	specifications			unit
			min	typ	max	
supply voltage	V _{DD}	※	4.75	5.0	5.25	V
	V _{EE}		-8.5	-7.5	-6.5	
	V _{EL}		f _{EL} =500Hz	80	110	
EL Driving Frequency	f _{EL}		300	500	1000	V _{rms} Hz
input voltage "H"	V _{IH}		2.8	-	-	V
input voltage "L"	V _{IL}		-	-	0.8	
output voltage "H"	V _{OH}		4.7	-	-	V
output voltage "L"	V _{OL}		-	-	0.3	
current consumption	I _{DD}	V _{DD} =5.0V	-	-	13.0	mA
	-I _{EE}	V _{EE} =-8.5	-	-	2.0	
	I _{EL}	V _{EL} =110V f _{EL} =500Hz	-	-	18.0	mArms

※ Power supply for contrast control

Contrast control power supply V_{EE} shall be variable for contrast and viewing angle control, and for temperature compensation. recommended V_{EE} (typical value) is as follows at each temperature.

temperature (°C)	V _{DD} -V _{EE} (V) (typ)
0	13.8
25	12.5
50	10.8

4. Optical specifications¹⁾

(Ta=25 °C, V_{DD}=5.0, V_{EE} : at the voltage for K_{max} between -6.5 ~ -8.5)

Item	symbol	condition	specifications			unit	note
			min	typ	max		
viewing angle	θ_U	$\phi = 0^\circ, K \geq 1.3$	40	-	-	deg.	1,2
	θ_H	$\phi = 180^\circ, K \geq 1.3$	15	-	-		
contrast ratio	K		2.5	4.0	-		3
response time	τ_r	$\phi = 0^\circ, \theta = 0^\circ$	-	200	350	ms	3,4
	τ_d		-	200	350		
Luminance		$\phi = 0^\circ, \theta = 0^\circ$ V _{EL} =110V f _{EL} =500Hz	4.0	6.0	-	cd/m ²	5,6

Note⁽¹⁾: Definition of ϕ , θ_{11} and θ_{12}

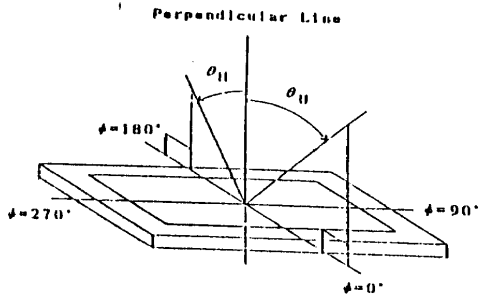

Note⁽²⁾: Definition of Contrast Ratio

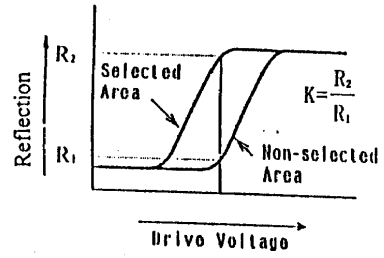

R_1 : reflection of selected Area
 R_2 : reflection of Non-selected Area

Note⁽³⁾: Definition of Viewing Angle
 Contrast ratio larger than 1.3 can be obtained by adjusting the V_{EE} value.

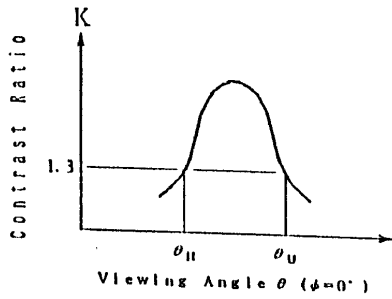

Note⁽⁴⁾: Definition of Turn ON time and Turn OFF time.

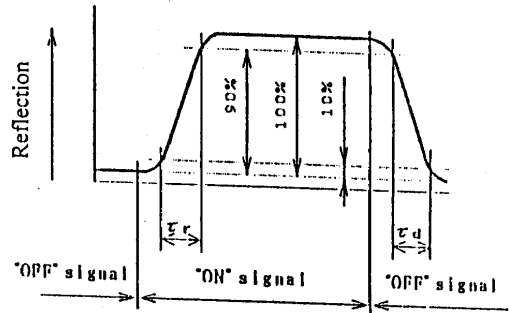

5. Dimensional Outline

Unit:mm

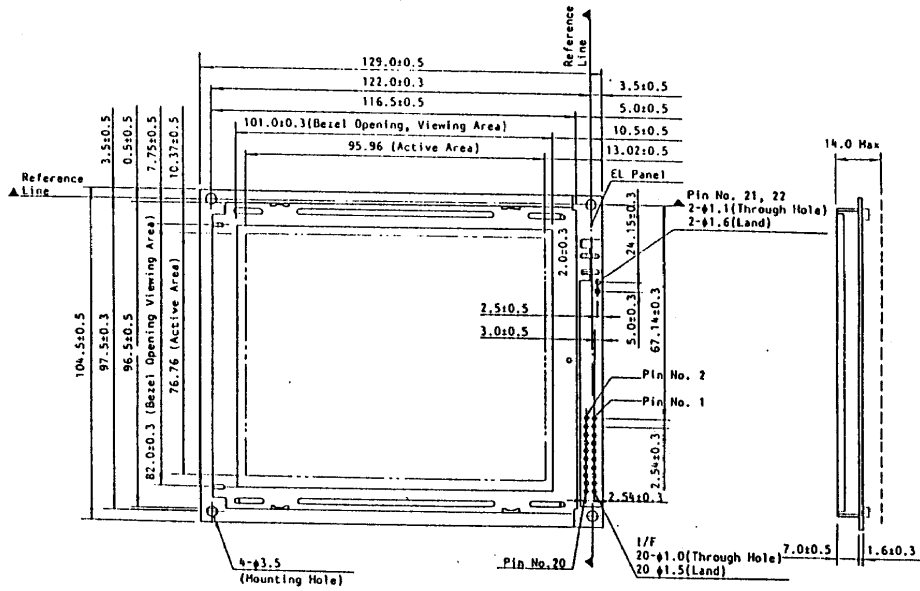

Detail of Pixels

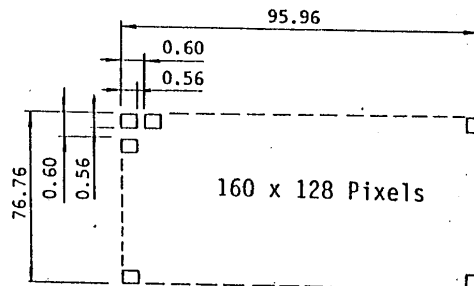

6. Interface
6.1 Interface Connection

Pin No.	Signal	Function
1	FGND	Frame ground
2	GND	Ground (signal ground)
3	V _{DD}	Power supply for logic
4	V _{EE}	Power supply for LCD drive (should be variable)
5	$\overline{\text{WR}}$	Data write (write data to the module at "L")
6	$\overline{\text{RD}}$	Data read (read data from the module at "L")
7	$\overline{\text{CE}}$	Chip enable for the module
8	C/D	$\overline{\text{WR}}="L":\overline{\text{C/D}}="H"$; command write, $\overline{\text{C/D}}="L"$; data write $\overline{\text{RD}}="L":\overline{\text{C/D}}="H"$; status read, $\overline{\text{C/D}}="L"$; data read
9	NC	No connection
10	$\overline{\text{RESET}}$	Module reset (controller reset)
11	D0	Data input/output (LSB)
12	D1	Data input/output
13	D2	Data input/output
14	D3	Data input/output
15	D4	Data input/output
16	D5	Data input/output
17	D6	Data input/output
18	D7	Data input/output (MSB)
19	FS (note 1)	Font select: connect to V _{DD} ; 6x8 pixels/chara. connect to GND; 8x8 pixels/chara.
20	NC	No connection
21	V _{EL}	Power supply for EL drive (only for the LCD module with EL backlight)
22	V _{ELG}	Power supply for EL drive (only for the LCD module with EL backlight)

6.2 Block Diagram of NTM164M21 (TLX-1013-E0) and NTM164M01 (TLX-1013-30)

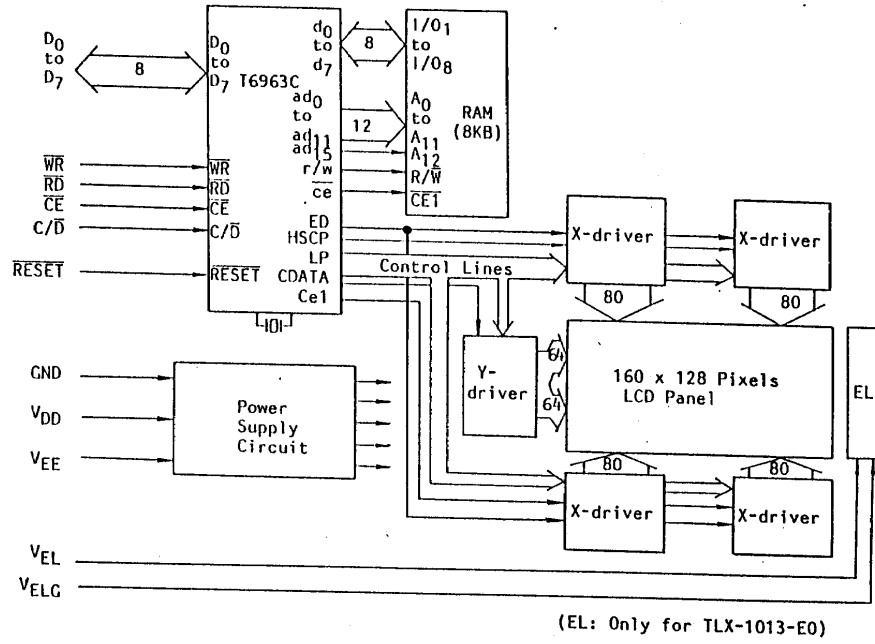

6.3 Signal Timings

Item	Symbol	Specifications		Unit
		Min.	Max.	
C/ \bar{D} Set Up Time	t_{CDS}	100	-	ns
C/ \bar{D} Hold Time	t_{CDH}	10	-	ns
\overline{CE} , \overline{RD} , \overline{WR} Pulse Width	t_{CE} , t_{RD} t_{WR}	80	-	ns
Data Set Up Time	t_{DS}	80	-	ns
Data Hold Time	t_{DH}	40	-	ns
Access Time	t_{ACC}	-	150	ns
Output Hold Time	t_{OH}	10	50	ns

Conditions: $V_{DD} = 5 \pm 0.25$ V, GND = 0 V, $T_a = 0$ to 50°C

Fig. 4.6 Bus Timing

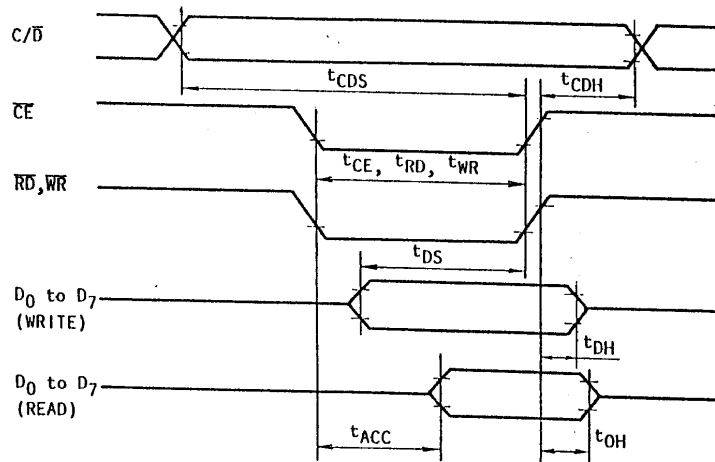

6.4 In case of 2 screen drive modules

TLX-1013 and TLX-1013-E0 is driven as 2 screen, so the relationship between display memory address and display position on LCD modules is shown in Figs. 1 and 2

Fig. 1 Text Display

TH	TH+1H	TH+TA-2H	TH+TA-1H	16 Lines
TH+TA	TH+TA+1H	TH+2TA-2H	TH+2TA-1H	
TH+6TA	TH+6TA+1H	TH+7TA-2H	TH+7TA-1H	
TH+7TA	TH+7TA+1H	TH+8TA-2H	TH+8TA-1H	
TH+8000H	TH+8000H+1H	TH+8000H+TA-2H	TH+8000H+TA-1H	
TH+8000H+TA	TH+8000H+TA+1H	TH+8000+2TA-2H	TH+8000H+2TA-1H	
TH+8000H+6TA	TH+8000H+6TA+1H	TH+8000H+7TA-2H	TH+8000H+7TA-1H	
TH+8000H+7TA	TH+8000H+7TA+1H	TH+8000H+8TA-2H	TH+8000H+8TA-1H	
20 Characters				

Fig. 2 Graphic Display

GH	GH+1H	GH+GA-2H	GH+GA+1H	128 Pixels
GH+GA	GH+GA+1H	GH+2GA-2H	GH+2GA-1H	
GH+62GA	GH+62GA+1H	GH+63GA-2H	GH+63GA-1H	
GH+63GA	GH+63GA+1H	GH+64GA-2H	GH+64GA-1H	
GH+8000H	GH+8000H+1H	GH+8000H+GA-2H	GH+8000H+GA-1H	
GH+8000H+GA	GH+8000H+GA+1H	GH+8000H+2GA-2H	GH+8000H+2GA-1H	
GH+8000H+62GA	GH+8000H+62GA+1H	GH+8000H+63GA-2H	GH+8000H+63GA-1H	
GH+8000H+63GA	GH+8000H+63GA+1H	GH+8000H+64GA-2H	GH+8000H+64GA-1H	
160 Pixels				

	Pixels/ Character	Text Display			Graphic Display		
		Number of Characters	Number of Lines	Text Area TA (Hex.)	Number of Horizontal Pixels	Number of Vertical Pixels	Graphic Area GA (Hex.)
TLX-1013 TLX-1013-E0	8x8	20	16	14H	160	128	14H

Note 1. In case of graphic display.

(8x8 pixels/character)

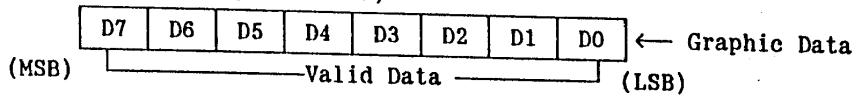

6.5 In case of TLX-1013 and TLX-1013-E0 (2 screen drive)

Display RAM is built-in the module, and display data is written to this display RAM. Built-in controller LSI T6963C is automatically read from display RAM, and send data to LCD drivers. "Control Word Set" command (Text Home Set, Text Area Set, etc.) define the RAM area which is read by controller LSI, so RAM map can be changed by user's preference. If more than 1 screen can be stored in the RAM, vertical scrolling and paging is easily performed by resetting text home and/or graphic home address. These modules have 8K byte RAM located at address 0000H to 0FFFH and 8000H to 8FFFH, and the following is an example of RAM mapping.

*** Example of RAM MAP ***

(Upper half screen)	
0000H	Graphic RAM Area (0000H to 07FFH: 2048 byte)
0800H	Attribute RAM Area
0A00H	Text RAM Area
0C00H	CG RAM Area (0C00H to 0FFFH: 1024 byte)
0FFFH	
(Lower half screen)	
8000H	Graphic RAM Area (8000H to 87FFH: 2048 byte)
8800H	Attribute RAM Area
8A00H	Text RAM Area
8C00H	Not used
8FFFH	

- Graphic home address 0000H
- graphic RAM for 16384 pixels
- Text home address 0A00H (text RAM for 512 characters)
- Offset register set D1 = "01H (CG RAM for 128 characters)

- Notes
- 1: If graphic/text home address is specified only for upper half screen, RAM map of lower half is automatically fixed.
 - 2: Above example of RAM map is for "CG ROM Mode", in case of "CG RAM Mode" is selected, 2048 byte CG RAM area is necessary. So above RAM map should be relocated.

6.6 Pin Setting of LCD Controller LSI (T6963C)

The pin setting of controller LSI (T6963C) is as follows:

Module No.	Display Size (Number of Row)	Columns of Display	Character Font (pixels/character)	Number of Screen	Operating Frequency of Controller T6963C (MHz)
TLX-1021 TLX-1021-E0	8 lines (64 pixels) ----- MDS="L" MD1="L" MD0="L"	32 columns ----- MD2="H" MD3="H"	8x8 ----- FS0="L" FS1="L"	1 screen ----- DUAL="H"	2.3±0.5
TLX-1013 TLX-1013-E0	16 lines (128 pixels) (2 screens) ----- MDS="L" MD1="L" MD0="L"	32 columns ----- MD2="H" MD3="H"	8x8 ----- FS0="L" FS1="L"	2 screens ----- DUAL="L"	4.55±0.5
TLX-711A TLX-711A-E0	8 lines (64 pixels) ----- MDS="L" MD1="L" MD0="L"	64 columns ----- MD2="H" MD3="L"	6x8 8x8 ----- FS0="L" (Note 1)	1 screen ----- DUAL="H"	4.55±0.5
TLX-1391 TLX-1391-E0	16 lines (128 pixels) ----- MDS="H" MD1="L" MD0="L"	32 columns ----- MD2="H" MD3="H"	6x8 8x8 ----- FS0="L" (Note 1)	1 screen ----- DUAL="H"	4.55±0.5
TLX-1301V	16 lines (128 pixels) ----- MDS="H" MD1="L" MD0="L"	40 columns ----- MD2="L" MD3="H"	6x8 8x8 ----- FS0="L" (Note 1)	1 screen ----- DUAL="H"	5.75±0.5

Note 1. In case of 6x8 pixels/character, FS1 is "H". In case of 8x8 pixels/character, FS1 is "L".

7. Communication Between CPU and Module

7.1 Control Sequence

7.1.1 Data Transmission Method

Built-in LCD controller T6963C is operating asynchronously to CPU clock, and following procedure is required for data transmission between module and CPU.

(1) Command with 2 byte data

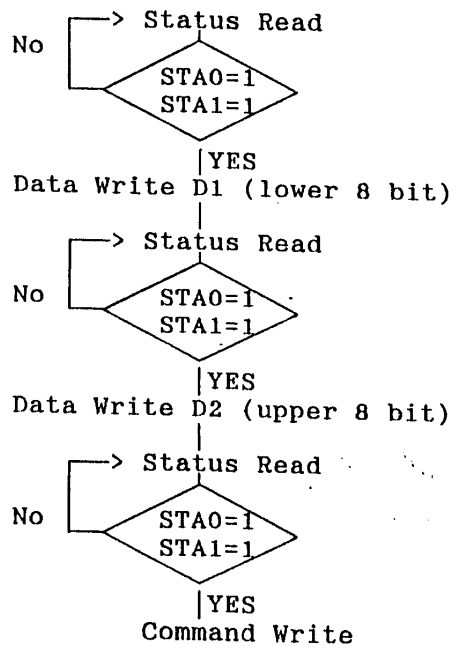

(2) Command with 1 byte data

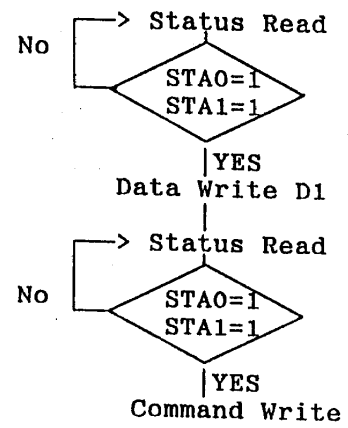

(3) Command with no data

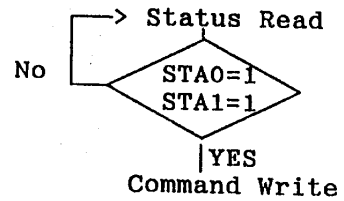

- (4) Data Auto Write/Data Auto Read
 STA2 or STA3 should be checked between all data and command.
 (Refer 5.2.2.6 "Data Auto Write/Data Auto Read")
- (5) Screen Peeking, Screen Copy
 STA6 should be checked just after "Screen Peeking"/"Screen Copy".
 (Refer 5.2.2.8/9 "Screen Peeking", "Screen Copy")

7.1.2 Status Read

Status of controller LSI should be checked between all command and data in order to complete communication with CPU. Status can be read from 8 bit data lines (D0 to D7) by setting C/\overline{D} ="H", \overline{RD} ="L".

STA0 (Busy1)	Check capability of instruction execution	STA0=0 : Disable =1 : Enable
STA1 (Busy2)	Check capability of data read or data write	STA1=0 : Disable =1 : Enable
STA2 (DAV)	Check capability of data read (only effective in auto mode)	STA2=0 : Disable =1 : Enable
STA3 (RDY)	Check capability of data write (only effective in auto mode)	STA3=0 : Disable =1 : Enable
STA4	-	-
STA5 (CLR)	Check possibility of controller operation	STA5=0 : Disable =1 : Enable
STA6 (Error)	Address pointer is out of graphic area on screen peeking and screen copy command	STA6=1 : Out of graphic area
STA7 (Blink)	Check the condition of blink	STA7=0 : Display off =1 : Normal display(on)

(Status Register)

STA7	STA6	STA5	STA4	STA3	STA2	STA1	STA0
MSB				LSB			

7.2 Command

7.2.1 Command List

Command	Command code								Description	Execution time (Max.) (Note 1)
	D7	D6	D5	D4	D3	D2	D1	D0		
Pointer Set	0	0	1	0	0	N2	N1	NO	N2 N1 NO 0 0 1 Cursor Pointer Set 0 1 0 Offset Resister Set 1 0 0 Address Pointer Set	Status check
Control Word Set	0	1	0	0	0	0	N1	NO	N1 NO 0 0 Text Home Address Set 0 1 Text Area Set 1 0 Graphic Home Address Set 1 1 Graphic Area Set	Status check
Mode Set	1	0	0	0	CG	N2	N1	NO	CG=0:CG ROM Mode CG=1:CG RAM Mode N2 N1 NO (Graphic and Text) 0 0 0 "OR" 0 0 1 "EXOR" 0 1 1 "AND" 1 0 0 Text only (attribute capability)	32x1/fOSC
Display Mode	1	0	0	1	N3	N2	N1	NO	N3=0:Graphic display off 1:Graphic display on N2=0:Text display off 1:Text display on N1=0:Cursor display off 1:Cursor display on NO=0:Cursor blink off 1:Cursor blink on	32x1/fOSC
Cursor Pattern Select	1	0	1	0	0	N2	N1	NO	N2,N1,NO specify the number of cursor lines (Example) N2 N1 NO 0 0 0 1 line cursor (bottom line) 1 1 1 8 line cursor (8x8 pixel cursor)	32x1/fOSC
Data Auto Read/Write	1	0	1	1	0	0	N1	NO	N1 NO 0 0 Data Auto Write Set 0 1 Data Auto Read Set 1 0 Auto Reset After this command, continuous data can be written or read. (address pointer automatically increment)	32x1/fOSC
Data Read/Write	1	1	0	0	0	N2	N1	NO	Data Read/Write command for 1 byte. N2=0:Address Pointer up/down =1:Address Pointer unchanged N1=0:Address Pointer up =1:Address Pointer down NO=0:Data Write =1:Data Read	32x1/fOSC
Screen Peeking	1	1	1	0	0	0	0	0	Transfer display data to data stack for read from CPU.	Status check
Screen Copy	1	1	1	0	1	0	0	0	1 line displayed data which address is indicated by address pointer is copied to graphic RAM area.	Status check
Bit Set/Reset	1	1	1	1	N3	N2	N1	NO	Set/Reset command for a bit in the address pointed by address pointer. N3=0:Bit Reset =1:Bit Set N2,N1,NO indicated the bit in the pointed address (000 is LSB, and 111 is MSB.)	Status check

Notes 1. Status check between all commands and data is recommended, though execution time for several commands are specified in above command list. For the commands with "Status Check" in execution time, execution time does not specified because it is influenced by internal situation of controller LSI.

7.2.2 Description of Command

7.2.2.1 Pointer Set Command

D1, D2,

0	0	1	0	0	N2	N1	N0
---	---	---	---	---	----	----	----

Command is selected by setting "1" at selected bit.

N2	N1	N0	Command	D1	D2
0	0	1	Cursor Pointer Set	Column position	Row position
0	1	0	Offset Register Set	Address	00H
1	0	0	Address Pointer Set	Address (lower)	Address(upper)

(a) Cursor Pointer Set

The cursor is displayed at the position specified by the D1, D2. The cursor position is shift only by this command, and does not shift by other command like a "Data Write" command. D1, D2 are specified as follows.

D1 : Horizontal cursor position counted by "character" (5 to 8 pixels width/character specified by hard setting ... refer 4.6 "Pin Setting of LCD controller LSI"). MSB of D1 is neglected, and 127 is the maximum.

D2 : Vertical cursor position counted by "character" (8 pixels high character).
Upper 3 bit are neglected and 32 is the Maximum. In case of TLX-1013 and TLX-1013-E0, first row of lower screen is "10H".

Note: Please note that the cursor position should be within actual display area.

(b) Offset Register Set

Offset Register Set command is used to determine character generator RAM area. The upper 5 bits in start address of CG area is set as the lower 5 bits of D1, and upper 3 bits of D1 is neglected. D2 should be 00H.

Refer 5.4 "Character Generator" for detail of CG RAM.

(c) Address Pointer Set

Address Pointer Set command is used to indicate the start address for writing data to built-in RAM, or for reading data from built-in RAM. The address should be located in the actual RAM area specified by individual specifications. (refer to 4.5 "RAM MAP")

7.2.2.2 Control Word Set Command

D1, D2,

0	1	0	0	0	0	N1	NO
---	---	---	---	---	---	----	----

Home address of display RAM (Text, Graphic), and areas are defined by this command.

N1	NO	Command	D1	D2
0	0	Text Home Address Set (TH)	Address (lower)	Address(upper)
0	1	Text Area Set (TA)	No. of column	00H
1	0	Graphic Home Address Set (GH)	Address (lower)	Address(upper)
1	1	Graphic Area Set (GA)	No. of column	00H

(a) Text Home Address Set (TH)

This command defines the starting address of display RAM for text display. The data in the Text home address (TH) is displayed at the home position of display (left end character on 1st row).

(b) Text Area Set (TA)

This command defines the number of column by D1. Text area can be defined independent from character No. fixed by hard setting of controller LSI. Text area is usually defined the same number as the actual character number of LCD display, so address can be continuous in text area in this case.

(c) Graphic Home Address Set (GH)

This command defines the starting address of display RAM for graphic display. The data in the Graphic Home Address (GH) is displayed at the home position of display (left end 8 bits in 1st line).

When using attribute function, Graphic Home Address indicates the starting address of attribute RAM area.

(d) Graphic Area Set (GA)

This command defines the number of column by D1. Graphic area can be defined independent from character No. fixed by hard setting of controller LSI. So address in graphic area can be continuous and RAM area can be used without uneffective area, if graphic area is defined the same number as the actual column number of LCD display. Note that graphic area will be different by character font setting even if horizontal pixel number is the same.

7.2.2.3 Mode Set Command

(No data)

1	0	0	0	CG	N2	N1	N0
---	---	---	---	----	----	----	----

Mode Set command selects character generator (CG ROM Mode/CG RAM Mode), and combination of text/graphic display.

CG	Command
0	CG ROM Mode: Built-in 128 character CG ROM (code:00H to 7FH) and built-in CG RAM for 128 characters (Code:80H to FFH) can be used
1	CG RAM Mode: Built-in CG RAM for 256 characters (code : 00H to FFH) can be used

When CG ROM Mode is selected, character code 00H to 7FH is selected from built-in CG ROM and 80H to FFH is automatically selected from CG RAM.

N2	N1	N0	Command
0	0	0	Logically "OR" of graphic and text display
0	0	1	Logically "EXOR" of graphic and text display
0	1	1	Logically "AND" of graphic and text display
1	0	0	Text display only (text can be attributed by the data in graphic area)

Logically "OR", "EXOR" and "AND" of graphic and text display can be displayed by this command. Only text display is attributed because Attribute RAM is located in Graphic RAM area.

7.2.2.4 Display Mode Set Command

(No data)

1	0	0	1	N3	N2	N1	N0
---	---	---	---	----	----	----	----

Display mode is selected from combination of following 4 bits by setting "1" at the selected bit.

	Command
N0	Cursor blink ON(N0=1) / Cursor blink OFF(N0=0)
N1	Cursor display ON(N1=1) / Cursor display OFF(N1=0)
N2	Text display ON(N2=1) / Text display OFF(N2=0)
N3	Graphic display ON(N3=1) / Graphic display OFF(N3=0)

After hard reset, all displays are inhibited.
(N0=N1=N2=N3=0).

7.2.2.5 Cursor Pattern Select Command

(No data)

1	0	1	0	0	N2	N1	NO
---	---	---	---	---	----	----	----

When cursor display is "ON", this command selects the cursor pattern from 1 line width cursor to 8 line width cursor (block).

N2	N1	NO	Cursor pattern
0	0	0	1 line width cursor
0	0	1	2 line width cursor
0	1	0	3 line width cursor
0	1	1	4 line width cursor
1	0	0	5 line width cursor
1	0	1	6 line width cursor
1	1	0	7 line width cursor
1	1	1	8 line width cursor

(1 line width cursor)

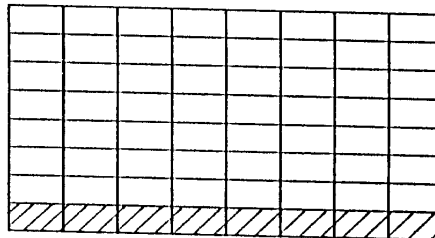

(8 line width cursor)

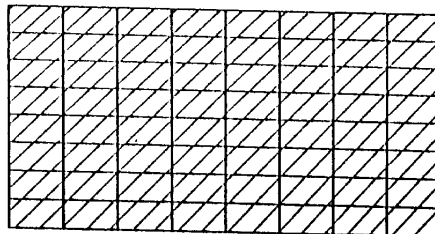

7.2.2.6 Data Auto Write/Data Auto Read

(No data)

1	0	1	1	0	0	N1	NO
---	---	---	---	---	---	----	----

This command is convenient to send full screen data, or receive full screen data from built-in RAM. After setting auto mode, "Data Write (or Read)" command is not necessary between each data.

"Data Auto Write (or Read)" command should follow the "Address Pointer Set" and address pointer is automatically increment by +1 after each data. After sending (or receiving) all data, Auto mode reset is necessary to return normal operation because all data is regarded "display data" and no command can be accepted in the auto mode.

N1	NO	Command
0	0	Data Auto Write Set
0	1	Data Auto Read Set
1	0	Auto Mode Reset

Note 1. Status check for auto mode (STA2 or STA3) should be checked between each data. Auto Reset should be performed after checking STA3=1 (Data Auto Write only).

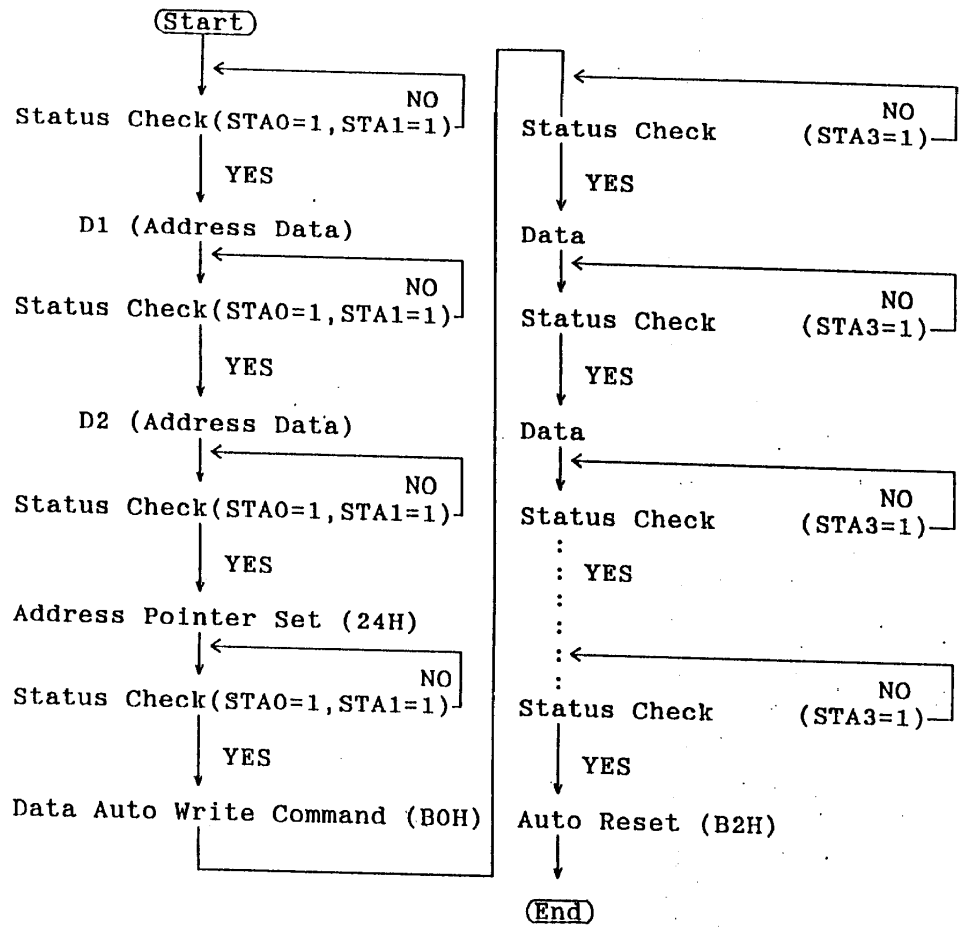

7.2.2.7 Data Write/Data Read

D1,

1	1	0	0	0	N2	N1	NO
---	---	---	---	---	----	----	----

Note 1. D1 is necessary only for Data Write.

This command is used for Data Write from CPU to built-in RAM, and Data Read from built-in RAM to CPU. Data Write/Data Read should be executed after setting address by Address Pointer Set command.

Address pointer can be automatically increment or decrement by setting this command.

N2	N1	NO	Command
0	0	0	Data Write (after execution, address pointer increment)
0	0	1	Data Read (after execution, address pointer increment)
0	1	0	Data Write (after execution, address pointer decrement)
0	1	1	Data Read (after execution, address pointer decrement)
1	0	0	Data Write (after execution, address pointer unchanged)
1	0	1	Data Read (after execution, address pointer unchanged)

This command is necessary for each 1 byte data.

7.2.2.8 Screen Peeking (Only for TLX-1301V with 6x8 Pixels/Chara.)

(No data)

1	1	1	0	0	0	0	0
---	---	---	---	---	---	---	---

This command is used to transfer displayed 1 byte data to data stack, and this 1 byte data can be read from CPU by Data Read command. So, logical combination data of text and graphic display on LCD screen can be read by this command. Status (STA6) should be checked just after "Screen Peeking" command. If the address determined by "Address Pointer Set" command is not in graphic RAM area, this command is ignored and status flag (STA6) is set.

The procedure to read displayed data by this command is as follows.

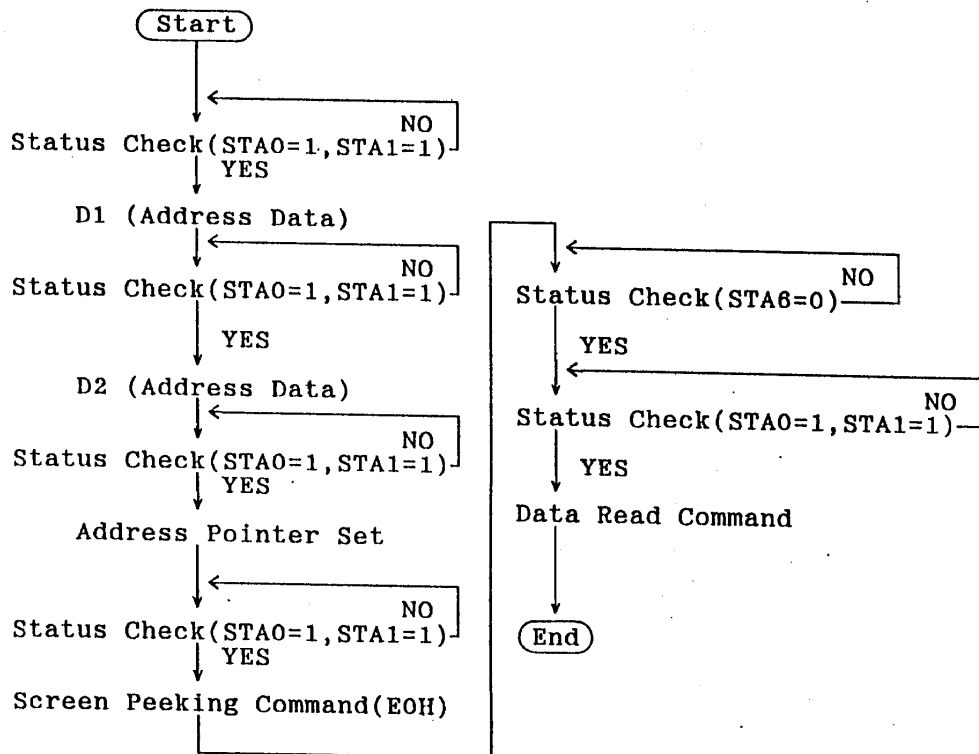

Screen Peeking command can be used for getting hardcopy of LCD display. Another application of this command is that modified CG is set in the CG RAM area by reading combination data of text and graphic data and writing to CG RAM area. For example, CG for reverse character is made by this method.

Note: For using this command, Text Area Set (TA) and Graphic Area Set (GA) should be defined as same number as "columns of display" in pin setting.

7.3 Initialization

Initialization of controller LSI T6963C is required for "Mode Set" and "Control Word Set" after power on.

Following is the example of initializing procedure of these modules.

Command	C/D	D7	D6	D5	D4	D3	D2	D1	D0	Hex.	Note
Power On	Power On										
Hard Reset (Use Reset Terminal)	Reset="L" (1 msec minimum after $V_{DD} \geq 4.75$ V)										
Mode Set	1	1	0	0	0	0	0	0	0	80H	"OR" mode
Control Word Set Graphic Home Position Set (Graphic Home Address 0000H)	0	0	0	0	0	0	0	0	0	00H	Graphic Home Address Command
	0	0	0	0	0	0	0	0	0	00H	
Number of Graphic Area Set	1	0	1	0	0	0	0	1	0	42H	Number of Graphic Area Command
	0	Note1	
Text Home Position Set (Text Home Address ****H)	1	0	1	0	0	0	0	1	1	43H	Text Home Address Command
	0	*	*	*	*	*	*	*	*	Note2	
Number of Text Area Set	0	*	*	*	*	*	*	*	*	Note2	Number of Text Area Command
	0	Note1	
(Initialize End) (Data Write)	1	0	1	0	0	0	0	0	0	41H	Number of Text Area Command
	0	Note1	
Address Pointer Set (Address Pointer 0000H)	0	0	0	0	0	0	0	0	0	00H	Graphic Home Address Command
	0	0	0	0	0	0	0	0	0	00H	
Data Write (Graphic)	1	0	0	1	0	0	1	0	0	24H	Data Command
	0	0	1	0	1	0	1	0	1	55H	
Data Write (Text)	0	1	1	1	0	0	0	0	0	AAH	Data Command
	1	1	1	1	0	0	0	0	0	COH	
Address Pointer Set (Address Pointer ****H)	0	*	*	*	*	*	*	*	*	Note2	Text Home Address Command
	0	*	*	*	*	*	*	*	*	Note2	
Data Write (Text)	1	0	0	1	0	0	1	0	0	24H	Text Home Address Command
	0	0	0	1	0	0	1	0	1	34H	
Display Mode Set (Text/Graphic on)	1	1	0	0	1	1	1	0	0	9CH	Data Command
	1	1	1	1	0	0	1	1	1	2FH	
Data Write (Text)	0	0	0	1	1	0	1	0	0	34H	Data Command
	1	1	1	1	0	0	1	1	1	COH	
Display Mode Set (Text/Graphic on)	1	1	0	0	1	1	1	0	0	9CH	Data Command
	1	1	1	1	0	0	1	1	1	2FH	

Note 1. Number of graphic and text area

Module No.	Pixels/Character	D7	D6	D5	D4	D3	D2	D1	D0	Hex.
TLX-1021 TLX-1021-E0	8x8	0	0	0	0	1	1	1	1	0FH
		0	0	0	0	0	0	0	0	00H
TLX-1013 TLX-1013-E0	8x8	0	0	0	1	0	1	0	0	14H
		0	0	0	0	0	0	0	0	00H
TLX-1391 TLX-1391-E0	6x8	0	0	0	1	0	1	1	0	16H
		0	0	0	0	0	0	0	0	00H
TLX-711A TLX-711A-E0	8x8	0	0	0	1	0	0	0	0	10H
		0	0	0	0	0	0	0	0	00H
TLX-711A TLX-711A-E0	6x8	0	0	1	0	1	0	0	0	28H
		0	0	0	0	0	0	0	0	00H
TLX-1301V	8x8	0	0	0	1	1	1	1	0	1EH
		0	0	0	0	0	0	0	0	00H
TLX-1301V	6x8	0	0	1	0	1	0	0	0	28H
		0	0	0	0	0	0	0	0	00H
TLX-1301V	8x8	0	0	0	1	1	1	1	0	1EH
		0	0	0	0	0	0	0	0	00H

Note 2: Text Home Address (****H) and start address for text data by Address Pointer Set command (****H) should be determined for each modules. The following is an example of Text Home Address. (Refer 4.5 "RAM Map")

	D7	D6	D5	D4	D3	D2	D1	D0	Hex.
1 Screen Drive	0	0	0	0	0	0	0	0	00H
	0	0	0	1	0	1	1	1	17H
2 Screen Drive	0	0	0	0	0	0	0	0	00H
	0	0	0	0	1	0	1	0	0AH

Notes 3: "Status Check" should be inserted between all command and data.
 4: Display Mode Set register is cleared (no display mode) by Hard Reset, and no display is appeared on LCD panel. And just after "Display Mode Set 9CH". Written data is displayed on the LCD.

7.4 Character Generator

7.4.1 Character Generator ROM

Character generator ROM for 128 characters is built-in this module.

"Mode Set" for "CG ROM Mode" should be selected before using built-in CG ROM.

Character pattern and character code is shown in following chart.

CG ROM PATTERN

(LSB)

(MSB) \ (LSB)	0	1	2	3	4	5	6	7	8	9	A	B	C	D	E	F
0																
1																
2																
3																
4																
5																
6																
7																

7.4.2 User Character Generator RAM

Character generator RAM is the built-in RAM which can be used as character generator after writing character pattern by program. The part of built-in RAM can be used as "User CG RAM" for 256 characters by selecting "CG RAM Mode", or for 128 characters by selecting "CG ROM Mode".

(1) Position of User CG RAM

The upper 5 bits in start address of User CG RAM (NNNNN) is defined by "Pointer Set" command (Offset Register Set), and following 2048 byte are defined as "User CG RAM" area when CG RAM Mode is selected. 1024 byte (address: NNNNN10000000000 to NNNNN11111111111) is defined as "User CG RAM" area when CG ROM Mode is selected.

(2) Writing to User CG RAM

Character pattern of specified CG code can be written in the pointed address by "Pointer Set" command (Address Pointer Set). 8 byte data should be sent to following 8 byte address for 1 character.

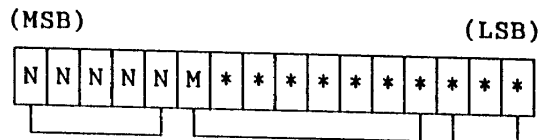

Upper 5 bit	CG code	Automatically
defined by	(8 bit)	scan for
"Pointer Set"	M=1 (for CG display	
command	ROM Mode)	
(Offset	M=0 (for CG	
Register Set)	RAM Mode)	

-
- (3) Display Pattern in User CG RAM
Character pattern can be displayed by sending CG code with "Data Write" command. But "Display Mode Set" for text display should be selected before using CG. In case that "CG ROM Mode" is selected, character pattern is selected from built-in CG ROM when MSB=0 (00H to 7FH), and from User CG RAM when MSB=1(80H to FFH).
In case that "CG RAM Mode" is selected, all character patterns are selected from User CG RAM (00H to FFH).
- (4) Relation between User CG RAM Address and CG code and Character Pattern
When character pattern is written to User CG RAM, relation between CG code and "User CG RAM" address is shown in the chart on next page.

Character Code 7 6 5 4 3 2 1 0	RAM Address for User CG F E D C B A 9 8 7 6 5 4 3 2 1 0	Character Pattern 7 6 5 4 3 2 1 0
M 0 0 0 0 0 0 0	N N N N N M 0 0 0 0 0 0 0 0 0 0 0	0 0 0 0 0 0 0 0 0 0 0 0 1 0 0 0 0 1 0 0 0 0 0 1 0 0 0 1 1 1 1 1 1 1 1 1 1 0 0 0 0 0 0 0 1 0 0 1 0 1 0 0 0 0 1 0 0 0 1 1 0 0 0 0 0 0 0 0 0 1 1 1 0 0 0 0 0 0 0 0
M 0 0 0 0 0 0 1	N N N N N M 0 0 0 0 0 0 0 1 0 0 0	0 1 0 0 0 0 0 1 0 0 1 1 0 0 0 1 1 0 0 1 0 1 1 0 1 0 1 0 0 1 1 0 1 1 0 1 0 1 0 1 0 0 0 1 0 0 0 0 1 0 1 0 1 0 1 0 0 0 0 1 0 1 1 0 0 1 0 0 0 0 1 0 1 1 1 0 0 0 0 0 0 1 0
M 0 0 0 0 0 1 0	N N N N N M 0 0 0 0 0 0 1 0 0 0 0	0 1 0 0 0 0 0 1 0 0 1 1 0 0 0 0 1 0 0 1 0 1 0 0 1 0 0 1 0 1 1 1 0 0 0 0 0 0
1 1 1 1 1 1 1 1	N N N N N 1 1 1 1 1 1 1 1 0 0 0	0 1 1 1 0 0 0 0 0 1 0 0 0 0 0 0 0 1 1 1 1 1 0 1 0 0 1 1 0 1 1 0 1 0 1 0 0 1 1 1 0 1 0 1 0 1 0 0 0 1 1 1 0 1 1 0 0 0 0 1 1 1 0 1 1 1 0 0 0 1 0 1 0

- Notes 1: "NNNNN" is the upper 5 bits in start address of User CG RAM defined by "Pointer Set" command (Offset Register Set).
- 2: It must be careful so that User CG RAM area should not be re written by display data etc.

7.5 Attribute

7.5.1 Attribute Function

These modules have attribute function for "Reverse Display", "Blink" and "Inhibit" in text display mode. Attribute data is written in the "Graphic Area" defined by "Control Word Set" command (Graphic Home Address Set and Graphic Area Set). So "Text Display Only" Mode should be selected by "Mode Set" command, and graphic display cannot be displayed. But please note that it is necessary to make "Graphic Display On" by "Display Mode" command after writing attribute data as shown 5.5.2.

The attribute data of the 1st character in "Text Area" is written at the 1st 1 byte in "Graphic Area", and attribute data of n-th character is written at the n-th 1 byte in "Graphic Area".

Attribute function is defined as follows.

Attribute RAM
1 byte

*	*	*	*	N3	N2	N1	N0
---	---	---	---	----	----	----	----

*: Don't care

N3	N2	N1	N0	Function
0	0	0	0	Normal display
0	1	0	1	Reverse display
0	0	1	1	Inhibit display
1	0	0	0	Blink of normal display
1	1	0	1	Blink of reverse display
1	0	1	1	Inhibit display

Note 1. Frequency of Blink (f_{BL})

$$f_{BL} = \frac{f_{OSC}}{64 \times m \times n \times 2}$$

f_{OSC} : Oscillation Clock Frequency of Controller T6963C
 m: Number of Horizontal pixels defined by pin setting of controller.
 (= (columns of display) × (Horizontal pixels of character font))
 n: Number of rows pixels
 Refer to 4.6 "Pin Setting of LCD Controller LSI (T6963C)"

2. The ON/OFF duty cycle ratio is 50:50

7.5.2 Procedure of setting attribute

The example of the setting procedure for attribute is as follows.

Command	C/ \bar{D}	D7	D6	D5	D4	D3	D2	D1	D0	Hex.	Note
Graphic Display Off	1	1	0	0	1	0	*	*	*	-	Note 1
Graphic Home Address Set	0	-	Note 2 Home Address ****H command
	0	-	
	1	0	1	0	0	0	0	1	0	42H	
Attribute Data Write	0	-	Note 2 Address ****H Address Pointer Set Attribute Data Data Write command Attribute Data Data Write command
	0	-	
	1	0	0	1	0	0	1	0	0	24H	
	0	0	0	0	0	0	0	0	0	00H	
	1	1	1	0	0	0	0	0	0	COH	
	0	0	0	0	0	1	1	0	1	0DH	
	1	1	1	0	0	0	0	0	0	COH	
	⋮	⋮	⋮	⋮	⋮	⋮	⋮	⋮	⋮	⋮	
Mode Set	1	1	0	0	0	0	1	0	0	84H	
Graphic Display On	1	1	0	0	1	1	*	*	*	-	Note 1

Notes 1. *: Don't care

2. Graphic Home Address (****H) and Attribute Data Write Address (****H) should be determined for each modules.

8. MARKING

Followings should be marked on the each modules.

Type Number
Manufacturer's name (Nanox)
Country of origin
Manufacturing lot number

9. QUALITY

9.1 Inspection AQL

Total of Major Defects : AQL 1.5 %
Total of Minor Defects : AQL 4.0 %
Sampling Method : ANSI/ASQC Z1.4 (Level II)

9.2 Test Conditions

Ambient Temperature : 25 ± 5 °C
Humidity : 65 ± 20 %RH
Illumination :

Visual inspection shall be performed under the single fluorescent lamp (20W) with about 50 cm distance from LCD module by naked eyes with 30 cm distance from the LCD module.

Viewing angle for inspection should be within viewing angle specified in this specification. Defects which is visible only in the surface glare shall be disregarded.

Operating conditions :

Unless otherwise specified, LCD module shall be operated by the rating value (typical value).

9.3 Dimensions

Item	Description	Class
Important Dimensions	Dimensional outline, Dimension between the mounting holes	Major
Others	Dimensions specified in this specification	Minor

9.4 Appearance

Item	Description	Class
PCB Appearance	*Pattern peeling, snapping, electrically short.	Major
	*Conductive pattern missing or pinhole larger than 30% of original width *Repair portion on PCB does not covered by epoxy resin.	Minor
Soldering	*Cold solder joint, lead move when pulled.	Major
	*Misalignment of pad and lead of flat package LSI (larger than 1/2 width of LSI lead).	Minor
Bezel, connectors	*Distinct stain, rust or scratch.	Minor
Black and White spots/line Contrast spots/line	Dust, foreign materials attached on the display surface is defined as "Black and White spot/lines" or "Contrast spots/lines" in 9.5. If these material is easily wiped off, they should be disregarded.	Minor
Display color/ Newton ring	*Distinct display color unevenness and newton ring.	Minor

9.5 Operational

Item	Description	Class																								
Function	No display, Malfunction	Major																								
Display Quality	Missing Line, missing pixel	Major																								
	Pinhole/pattern deformation larger than 0.3 mm	Minor																								
	Abnormal flickering/Waving observed	Minor																								
Uniformity	Uniformity of background/display	Minor																								
Black, White and Bright spots/line Note (14)	<table border="0"> <tr> <td>*Average diameter(mm)</td> <td colspan="2">Acceptable No.</td> </tr> <tr> <td>$D \leq 0.2$</td> <td colspan="2">neglect</td> </tr> <tr> <td>$0.2 < D \leq 0.3$</td> <td colspan="2">$N \leq 5$</td> </tr> <tr> <td>$0.3 < D$</td> <td colspan="2">$N = 0$</td> </tr> <tr> <td>*Line width(mm)</td> <td>Length(mm)</td> <td></td> </tr> <tr> <td>$W \leq 0.03$</td> <td>neglect</td> <td>good</td> </tr> <tr> <td>$0.03 < W \leq 0.05$</td> <td>$L \leq 2$</td> <td>$N \leq 5$</td> </tr> <tr> <td>$0.05 < W \leq 0.07$</td> <td>$L \leq 1$</td> <td>$N \leq 5$</td> </tr> </table>	*Average diameter(mm)	Acceptable No.		$D \leq 0.2$	neglect		$0.2 < D \leq 0.3$	$N \leq 5$		$0.3 < D$	$N = 0$		*Line width(mm)	Length(mm)		$W \leq 0.03$	neglect	good	$0.03 < W \leq 0.05$	$L \leq 2$	$N \leq 5$	$0.05 < W \leq 0.07$	$L \leq 1$	$N \leq 5$	Minor
*Average diameter(mm)	Acceptable No.																									
$D \leq 0.2$	neglect																									
$0.2 < D \leq 0.3$	$N \leq 5$																									
$0.3 < D$	$N = 0$																									
*Line width(mm)	Length(mm)																									
$W \leq 0.03$	neglect	good																								
$0.03 < W \leq 0.05$	$L \leq 2$	$N \leq 5$																								
$0.05 < W \leq 0.07$	$L \leq 1$	$N \leq 5$																								
Contrast spots/lines (low contrast spots/lines, defects of reflector) Note (14)	<table border="0"> <tr> <td>*Average diameter</td> <td colspan="2">Acceptable No.</td> </tr> <tr> <td>$D \leq 0.5$ (mm)</td> <td colspan="2">good</td> </tr> <tr> <td>$0.5 < D \leq 1.0$</td> <td colspan="2">$N \leq 5$</td> </tr> <tr> <td>$1.0 < D$</td> <td colspan="2">$N = 0$</td> </tr> <tr> <td>*Contrast line width</td> <td>Length</td> <td>Acceptable No.</td> </tr> <tr> <td>$W \leq 0.05$(mm)</td> <td>neglect</td> <td>good</td> </tr> <tr> <td>$0.05 < W \leq 0.07$</td> <td>$L \leq 2.0$(mm)</td> <td>$N \leq 5$</td> </tr> </table>	*Average diameter	Acceptable No.		$D \leq 0.5$ (mm)	good		$0.5 < D \leq 1.0$	$N \leq 5$		$1.0 < D$	$N = 0$		*Contrast line width	Length	Acceptable No.	$W \leq 0.05$ (mm)	neglect	good	$0.05 < W \leq 0.07$	$L \leq 2.0$ (mm)	$N \leq 5$	Minor			
*Average diameter	Acceptable No.																									
$D \leq 0.5$ (mm)	good																									
$0.5 < D \leq 1.0$	$N \leq 5$																									
$1.0 < D$	$N = 0$																									
*Contrast line width	Length	Acceptable No.																								
$W \leq 0.05$ (mm)	neglect	good																								
$0.05 < W \leq 0.07$	$L \leq 2.0$ (mm)	$N \leq 5$																								
Current Consumption	Out of specifications	Minor																								
Contrast ratio/viewing angle	Out of specifications	Minor																								
Response time	Out of specifications	Minor																								
Backlight	No backlighting	Major																								
	Uniformity of backlight brightness	Minor																								

Note (14): Average diameter D is defined as follows;

$$D = \frac{a + b}{2} \text{ [mm]}$$

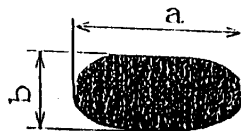

10. RELIABILITY

The LCD module shall have no failure in the following reliability tests.

Test Item	Test Conditions	Note
High Temperature Storage	60°C, 200hrs	2
Low Temperature Storage	-20°C, 200hrs	2
Humidity Storage	60°C, 70%RH, 200hrs	1, 2
High Temperature Operation	50°C, $V_{DD}=5.0V$, 200hrs	2
Low Temperature Operation	0°C, $V_{DD}=5.0V$, 200hrs	1, 2
Temperature Cycling	-20°C \rightleftharpoons 60°C 2hr. 30min. 2hr. 5 cycles	1, 2
Mechanical Shock	50G, 20ms X, Y, Z each directions(1time)	—
Mechanical Vibration	10 to 250 to 10Hz sweep, 0.5G, 30minutes X, Y, Z each directions	—

Note 1. The module should not have condensation of water on the module.

Note 2. The module should be inspected after 1 hour storage in normal conditions(15to35°C, 45to65%RH)

We hope to correct these discription as follows;

1. Current consumption is more than specified value.
2. Function of the module is not maintained.
3. There is visible degradation of apperance and display quality.
4. Contrast ratio is less than 50% of specified minimum value.
5. Brightness is less than 50% of specified minimum value.

MTTF: LCD Module 50000hr (typ)

11. WARRANTY

11.1 Incoming Inspection

Customer has the right to perform incoming inspection for the lot acceptance/rejection. Lot rejection should be informed to NSG within a month from the shipping date.

Customer also has the right to reject any individual display that does not function properly, or does not mechanically fit or does not meet cosmetic specification described in this specification.

11.2 Warranty Period

NSG warrants for a period of 15 months from the shipping date when stored or used under normal conditions.

12. INSTALLATION

For installation of the module, use four mounting holes located at the corner of the bezel. The Bezel is not intended to be used as a cosmetic purpose. The proper protective cover(lens) over the LCD surface and the proper enclosure are recommended to be attached in order to prevent polarizer surface from scratching or staining. The transparent opening dimensions of protective cover are recommended to be smaller than the viewing area specified in Section 4.

13. Caution and Handling Precaution

(1) Handling

- (a) Refrain from strong mechanical shock and from applying any force to LCD module.
It may cause misoperation or damage of LCD and FL backlight.
- (b) Note that polarizers are so soft as being easily damaged.
Do not press or scratch these surface with any hard object, and do not put the heavy material on the polarizer.
- (c) If LCD is broken and liquid crystal material flow out, ingestion, inhalation, or contact with skin should be avoided. If liquid crystal material contact with skin, wash immediately with alcohol and rinse thoroughly with water.
- (d) The polarizer laminated to the LCD and adhesives be attacked by organic solvent. When LCD surface become dirty, wipe softly with absorbent cotton wet with petroleum benzine.
- (e) Refrain from discharge of high electro-static voltage.
It will damage CMOS LSI in the module. So, be sure that person handling modules, tools like soldering iron, screw driver and working bench are grounded.
- (f) Be careful not to be struck by electric shock of FL backlight.
- (g) Do not handle with power applied, because high voltage is applied to module.
(especially to CCFL lamp)

(2) Storage

- (a) Do not leave the module in high temperature, especially in high humidity for a long time. It is recommended to store the module where the temperature is in the range of 0°C to 35°C and the humidity is lower than 70%.
- (b) Store the module without exposure to direct sunlight or fluorescent lamp.

(3) Operation

- (a) Do not insert or remove LCD module from main system with power applied.
- (b) Power supplies should always be turned on before the input signals are applied and the input signals should be turned off before power supplies turned off.
- (c) Following power supply sequence is requested in order to keep better display quality and reliability.

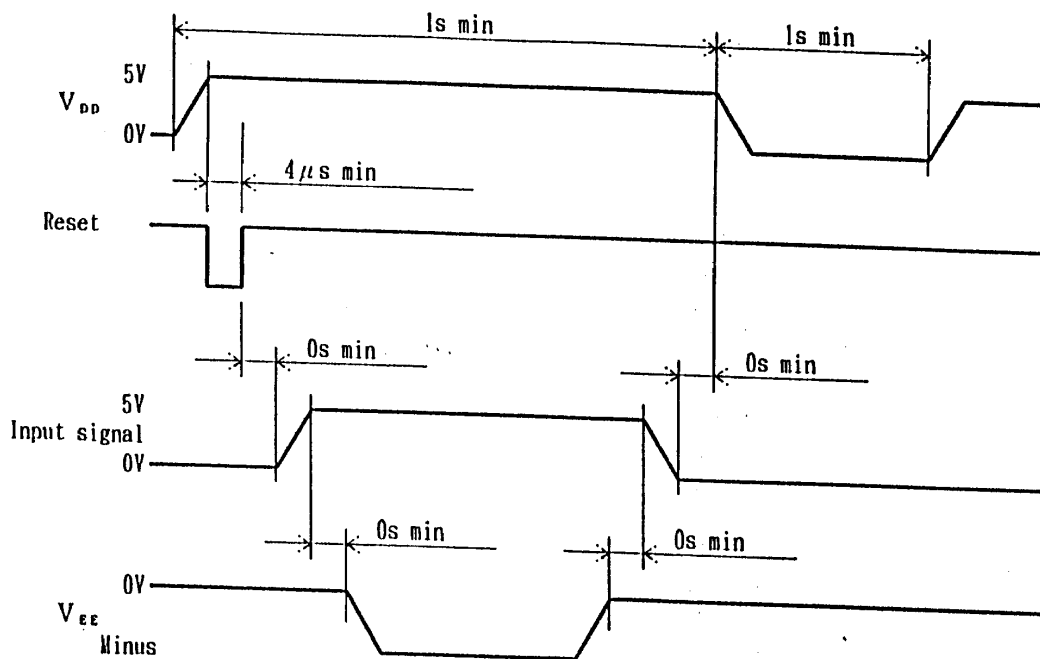

(4) Others¹

- (a) Ultra-violet ray cut filter is necessary for outdoor operation.
- (b) Avoid condensation of water, it may cause misoperation or disconnection of electrode.
- (c) Do not exceed the maximum rating values under the worst probable conditions taking into account the supply voltage variation, input voltage variation, variation in part constants, and environmental temperature, etc. otherwise LCD module may be damaged.
- (d) The input current to this LCD module from the system is required to limit its value as listed in the following table. It is because the LCD explained in this data sheet does not incorporate a current limiter, or a circuit with such function, and there may be some possibility of overheat and/or burning of LCD module and its peripheral devices in the system when the module is malfunctioning.

When a fuse is used as a limiter, it is required to confirm its Rated Current and Pre-arcing Time Characteristics in order to match with a system power supply and the LCD module.

The Table below also shows the recommended Rating of a "Quick-arching Fuse" for this purpose.

Power Supply	Required input current to LCD module from the system	Recommended ratings of quick-arching Fuse
V _{DD}	Below 4.0A	0.5A to 1.0A (F1)
V _{EE}	Below 4.0A	0.5A to 1.0A (F2)