



## UM3758 Series

### Tri-State Programmable Encoder/Decoder

#### Features

- Single-Chip CMOS construction
- Single-Chip **encoder/decoder** selected by jump wire
- Wide operating voltage range : V<sub>Do</sub> = 3 to 12 Volts
- Built-in RC oscillator (can use 5 % resistor)
- Easy interface with RF, **Infrared(IR)** and **Ultrasonic** transmission media
- Tri-state(0, 1, open) address codes, some of address

codes used as data **codes** or as internal addresses by mask **option**

- Internal address **code** is **18-bit**, ie  $3^{18} = 387,428, 489$  different **codes** at most
- Decoder has **8-bit** latch data
- Series **IC** for various applications
- **UM3758-120A** pin outcompatible to UM3750

#### General Description

The UM3758 series are **single-chip** programmable **encoder/decoder ICs** fabricated in CMOS structure for low power consumption. They are enhanced for new stage encoder/decoder **ICs** to provide many more combinations for **higher security**.

Most combinations are achieved by **UM3758-180A**, providing  $3^{18} = 387,420,489$  combinations. Some **ICs** of this series provide 4 to 8 data bits for controlling.

According to the following information, The **internal address bits**, **18 bits/24-pin** and **12 bits/18-pin package**, can be assigned by customer in **advance** for **much higher security** and confidentialii. Whenever the address **codes** of **transmitter** transmits, the **receiver** will check the address codes with his own and the successive two **matched** address codes will generate a low pulse. If there were any data bits, the **receiver** will latch these data bis at the corresponding pins for controlling.

#### Pin Configurations

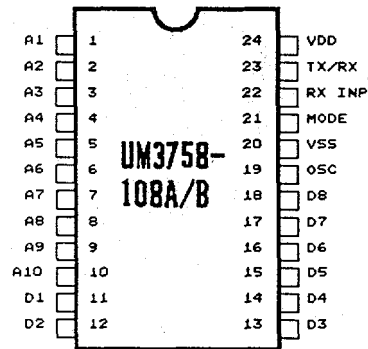
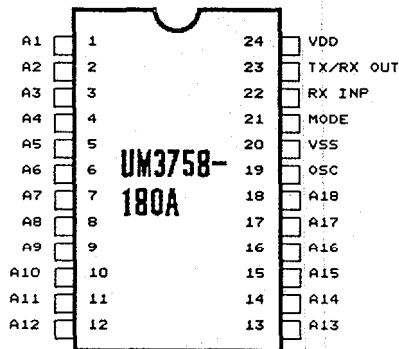

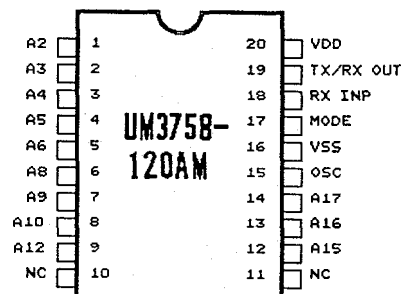
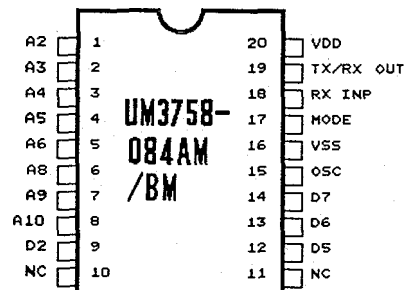
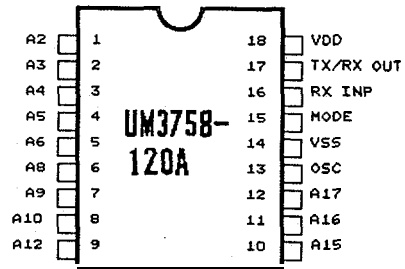
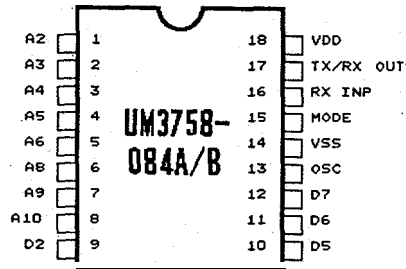
**Pin Configurations (Continued)**

**Absolute Maximum Ratings\***

Power Supply Voltage . . . . . -0.3V to 11V  
 Operating Temperature . . . . . -20°C to 70°C  
 Storage Temperature (Tstg) . . . . . -55°C to 150°C  
 Apply Voltage on any Pin . . . . .  
 $V_{SS} - 0.3 < V_{IN} < V_{DD} + 0.3$

**\*Comments**

Stresses above those listed under "Absolute Maximum Ratings" may cause permanent damage to the device. These are stress ratings only. Functional Operation of this device at these or any other conditions above those indicated in the operational sections of this specification is not implied and exposure to absolute

**DC Electrical Characteristics**

( $T_A = 25^\circ\text{C}$ ,  $V_{DD} = 9$  Volts,  $V_{SS} = 0\text{V}$  unless otherwise specified)

Parameter	Symbol	Min.	TYP.	Max.	Unit	Conditions
Operating voltage	$V_{DD}$	3.0		12	V	
Operating current	$I_{op}$	-		1.2	mA	
Schmitt Trigger input level	$V_{sh}$ $V_{sl}$	6 -	- -	2	V V	HIGH LOW
Other pins input level	$V_{ih}$ $V_{il}$	8.5 0	-	9 0.5	V v	HIGH LOW
Output pin logic level	$V_{oh}$ $V_{ol}$	8.5 0		9 1	V v	HIGH LOW
DATA output current						$V_{DD} = 12\text{V}$ $V_{oh} = 6\text{V}$ $V_{ol} = 6\text{V}$
HIGH level	$I_{ohd}$	9			mA	
LOW level	$I_{old}$	9			mA	

**DC Electrical Characteristics (Continued)**

Parameter	Symbol	Min.	Typ.	Max.	Unit	Conditions
TX/RX OUTput current HIGH level LOW level	Ioht Iolt	35 15			mA mA	VDD = 12V Voh = 6V Vol = 6V
Operating frequency	F	-	160		KHz	+ 15% exclusive of external part

**Pin Descriptions**
**1. UM3758-180A/AM, UM3758-120A and UM3758-120AM**

Pin Number			Designation	Description
UM3758 -180A /AM	UM3758 -120A	UM3758 -120AM		
1			A1	Address select line 1 is tri-state indicated as 0, 1 and open
2	1	1	A2	Address select line 2 is tri-state indicated as 0, 1 and open
3	2	2	A3	Address select line 3 is tri-state indicated as 0, 1 and open
4	3	3	A4	Address select line 4 is tri-state indicated as 0, 1 and open
5	4	4	A5	Address select line 5 is tri-state indicated as 0, 1 and open
6	5	5	A6	Address select line 6 is tri-state indicated as 0, 1 and open
7			A7	Address select line 7 is tri-state indicated as 0, 1 and open
8	6	6	A8	Address select line 8 is tri-state indicated as 0, 1 and open
9	7	7	A9	Address select line 9 is tri-state indicated as 0, 1 and open
10	8	8	A10	Address select line 10 is tri-state indicated as 0, 1 and open
11	-	-	A11	Address select line 11 is tri-state indicated as 0, 1 and open

## Pin Descriptions (Continued)

Pin Number			Designation	Description
UM3758 -180A /AM	UM3758 -120A	UM3758 -120AM		
12	9	9	A12	Address select line 12 is tri-state indicated as 0, 1 and open
		10	NC	No connection
		11	NC	Noconnection
13		—	A13	Address select line 13 is tri-state indicated as 0, 1 and open
14	—		A14	Address select line 14 is tri-state indicated as 0, 1 and open
15	10	12	A15	Address select line 15 is tri-state indicated as 0, 1 and open
16	11	13	A16	Address select line 16 is tri-state indicated as 0, 1 and open
17	12	14	A17	Address select line 17 is tri-state indicated as 0, 1 and open
16		—	<b>A18</b>	Address select line 16 is tri-state indicated as 0, 1 and open
19	13	15	o s c	R.C. input pin for single pin oscillator. A resistor is connected from this pin to V <sub>DD</sub> and a capacitor to V <sub>SS</sub>
20	14	16	v s s	The ground pin for UM3756
21	15	17	MODE	This pin is used to select transmit or receive mode MODE — V <sub>DD</sub> : Encoder mode MODE — V <sub>SS</sub> : Decoder mode
22	16	18	RXINP	<b>Receiver</b> input pin. Receives waveform from the detect circuit
23	17	19	TX/RX OUT	In <b>encoder</b> mode, this pin will transmit waveform; in <b>decoder</b> mode, this pin will switch to LOW if comparison is OK
24	18	20	VDD	The positive power supply of UM3756



2. UM3758-108A/B/AM/BM, UM3758-084A/B and UM3758-084AM/BM

Pin Number			a t t i o n	Description
UM3758 108A/B AM/BM	UM3758 -084 A/B	UM3758 -084AM /BM		
1	-	-	A1	Address select line 1 is tri-state indicated as 0, 1 and open
2	1	1	A2	Address select line 2 is tri-state indicated as 0, 1 and open
3	2	2	A3	Address select line 3 is tri-state indicated as 0, 1 and open
4	3	3	A4	Address select line 4 is tri-state indicated as 0, 1 and open
5	4	4	A5	Address select line 5 is tri-state indicated as 0, 1 and open
6	5	5	A6	Address select line 6 is tri-state indicated as 0, 1 and open
7	-	-	A7	Address select line 7 is tri-state indicated as 0, 1 and open
a	6	6	A8	Address select line 8 is tri-state indicated as 0, 1 and open
9	7	7	A9	Address select line 9 is tri-state indicated as 0, 1 and open
10	a	8	A10	Address select line 10 is tri-state indicated as 0, 1 and open
11			D1	Data output pin 1, states are either HIGH (1 or open) or LOW (0)
12	9	9	D2	Data output pin 2, states are either HIGH (1 or open) or LOW (0)



**Pin Descriptions (Continued)**

Pin Number			Designation	Description
UM3758 -108A/B /AM/BM	UM3758 -084 A/B	UM3758 -084AM /BM		
-		10	NC	Noconnection
		11	NC	No connection
13		-	D3	Data output pin 3, states are either HIGH (1 or open) or LOW (0)
14	-	-	D4	Data output pin 4, states are either HIGH (1 or open) or LOW (0)
15	10	12	D5	Data output pin 5, states are either HIGH (1 or open) or LOW (0)
16	11	13	D6	Data output pin 6, states are either HIGH (1 or open) or LOW (0)
17	12	14	D7	Data output pin 7, states are either HIGH (1 or open) or LOW (0)
<b>18</b>	-		<b>D8</b>	Data output pin 6, states are either <b>HIGH</b> (1 or open) or LOW (0)
19	13	15	osc	R.C. input pin for single pin oscillator. A resistor is connected from this pin to V <sub>Do</sub> and a capacitor to V <sub>ss</sub>
20	14	16	vss	The ground pin for UM3756
21	15	17	MODE	This pin is used to select transmit or receive modes MODE — V <sub>Do</sub> : Encoder mode MODE — V <sub>ss</sub> : Decoder mode
22	16	<b>18</b>	RXINP	Receiver input pin. Receives waveform from the detect circuit
23	17	19	TX/RX OUT	In encoder mode, this pin will transmit waveform; in decoder mode, this pin will switch to LOW if comparison is OK
24	<b>18</b>	20	VDD	The positive power supply of UM3756

## Functional Description

### General

The operating mode of the UM3756 series is controlled by the MODE pin. When the 'MODE' pin is connected to VDD the circuit will automatically switch to encoder mode, then "TX/RX OUT" pin acts as data out pin and 'RX INP' pin act as an idle pin. When 'MODE' pin is connected to VSS the circuit will switch to decoder mode, then "TX/RX OUT" pin will switch to LOW if comparison is OK, otherwise this pin will keep HIGH, and "RX/INP" receives waveform from detect circuit.

### Encoder Mode

The encoder mode is selected by connecting "MODE" pin to VDD.

The transmit sequence is initiated by the power connection and continuously transmits till power down. Each transmitted address bit is encoded into address

pulses (see Fig. 1). A logic zero is encoded as two consecutive long pulses, a logic one as two consecutive short pulses and an open as a long pulse followed by a short pulse. Each transmitted data bit is encoded into logic zero or one and the data pulse is the same as the address pulse (see Fig. 1), ie., the state of data pin is either one or zero. The data is one when connected to VDD or open and zero when connected to VSS.

The UM3758-180A samples the 18 bit tri-state address and encodes this parallel address data for transmitting. These 16 address pins may be in either of three states (0, 1, open) allowing  $3^{18} = 387,420,489$  possible combinations then the UM3758-120A provides 12-bit address and allows  $3^{12} = 531,441$  possible combinations.

The UM3758-108A/B and UM3758-084A/B provide address bits and data bits, as described in Table 1.

Part Number	Address Bits	Address Combinations	Data Bits	Data Combinations
UM3758-108A/B/AM/BM	10	59,049	8	256
UM3758-084A/B/AM/BM	a	6,561	4	16

Table 1

### Decoder Mode

The decoder mode is selected by connecting "MODE" pin to vss.

The decoder receives the serial data from the detect circuit and outputs the comparison result or data, if it is valid. The received data may include two types — without data and with data.

For decoder without data ICs, such as UM3758-180A and UM3758-120A the address word is examined bit by bit as received; if two successive address words match the address bis of decoder, the "TX/RX OUT" pin will switch to LOW and two successive unmatched address words will cause "TX/RX OUT" pin to return to HIGH (see Fig. 3-1).

For decoder with data IC, such as UM3758-108A/B and UM3758-084A/B, the address word with data word are examined bit by bi as received. The first 10 bits

(ex. UM3758-108A/B) are assumed to be address bi. If the address bits match the address bits from detect circuit, the next eight data bits are stored and matched to the last valid data stored. When the second word with data is received, the address bis must match again, and if it does, the data bits are checked against the previous stored data biis. If the two words (eight bits data each) of data match, the data is transferred to the output data pins (D1, D2 to D8). If the decoder is momentary type, the data pins will latch the data till the "TX/RX OUT" pin switches to HIGH; for latch decoder, the data pins will latch the data till the next valid data appears (see Fig. 3-2). Although the address bits are tri-state (0, 1, open), the data information must be either one or zero. An open state will be decoded as a logic one. The above table (Table 1) also describes these (decoder with data).

## Timing Waveforms

### Tri-State Encoded Pulses

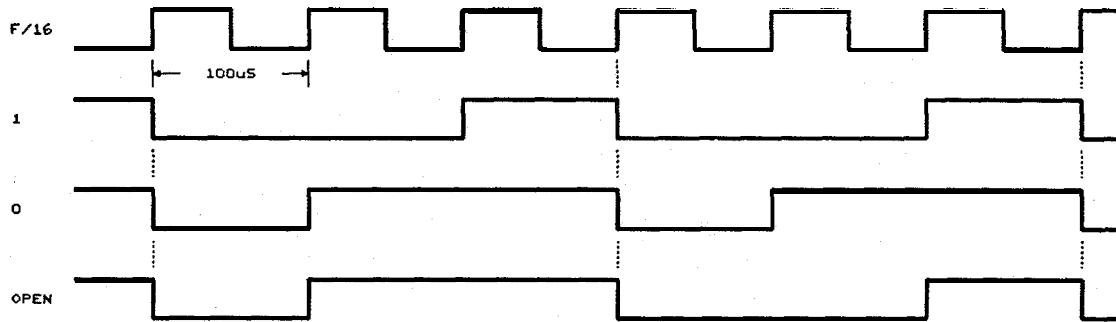

Fig. 1

### Encoder Mode

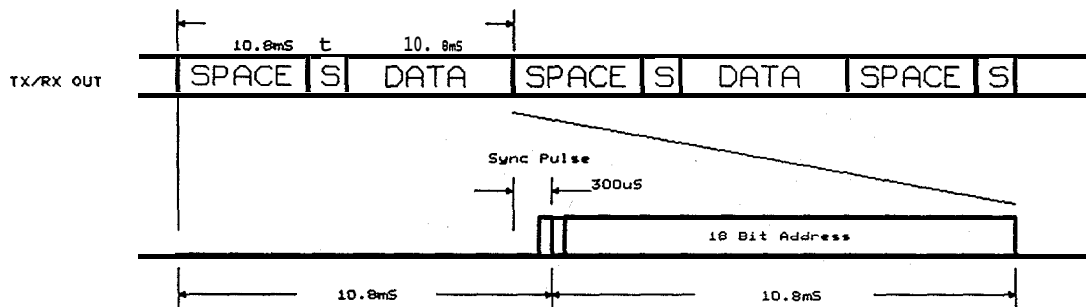

Fig. 2

### Decoder Mode (without data) :

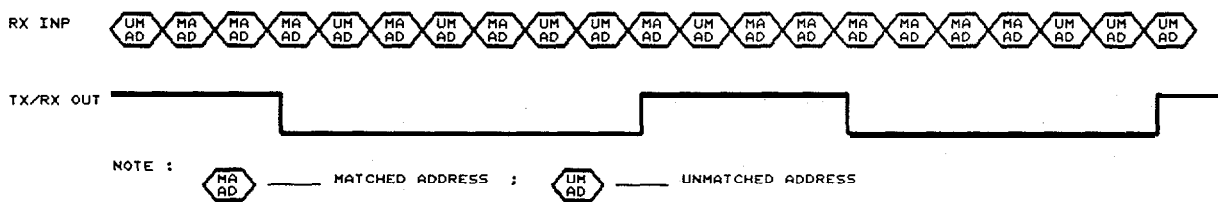

Fig. 3-1



**Timing Waveforms (Continued)**

Decoder Mode (with data) :

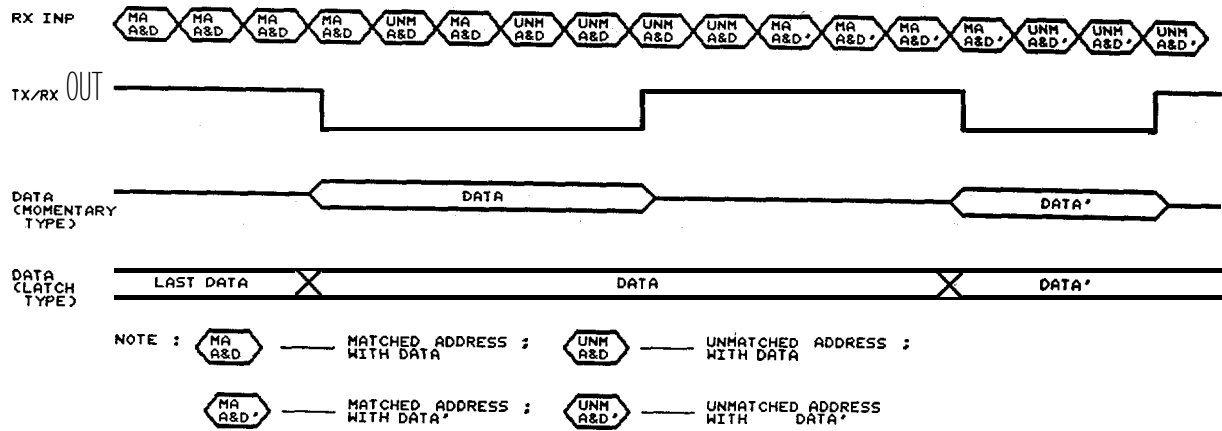
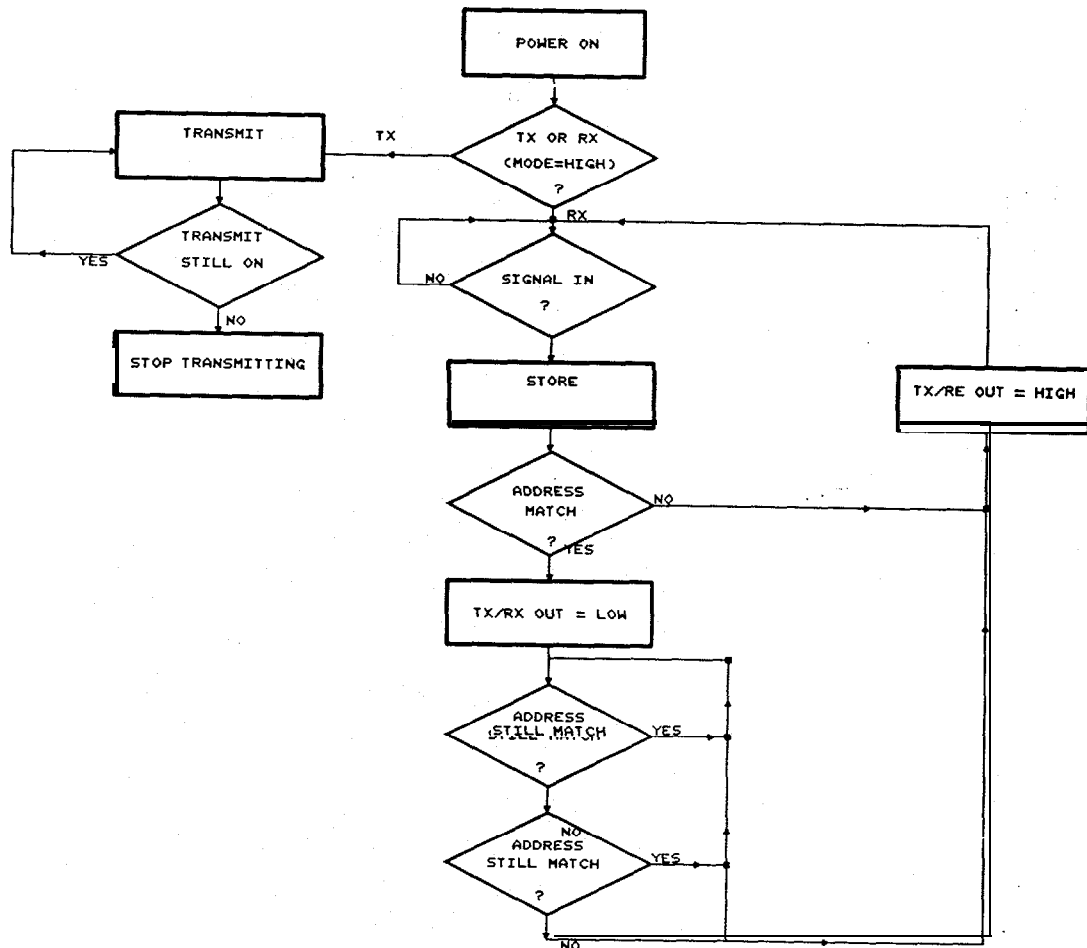
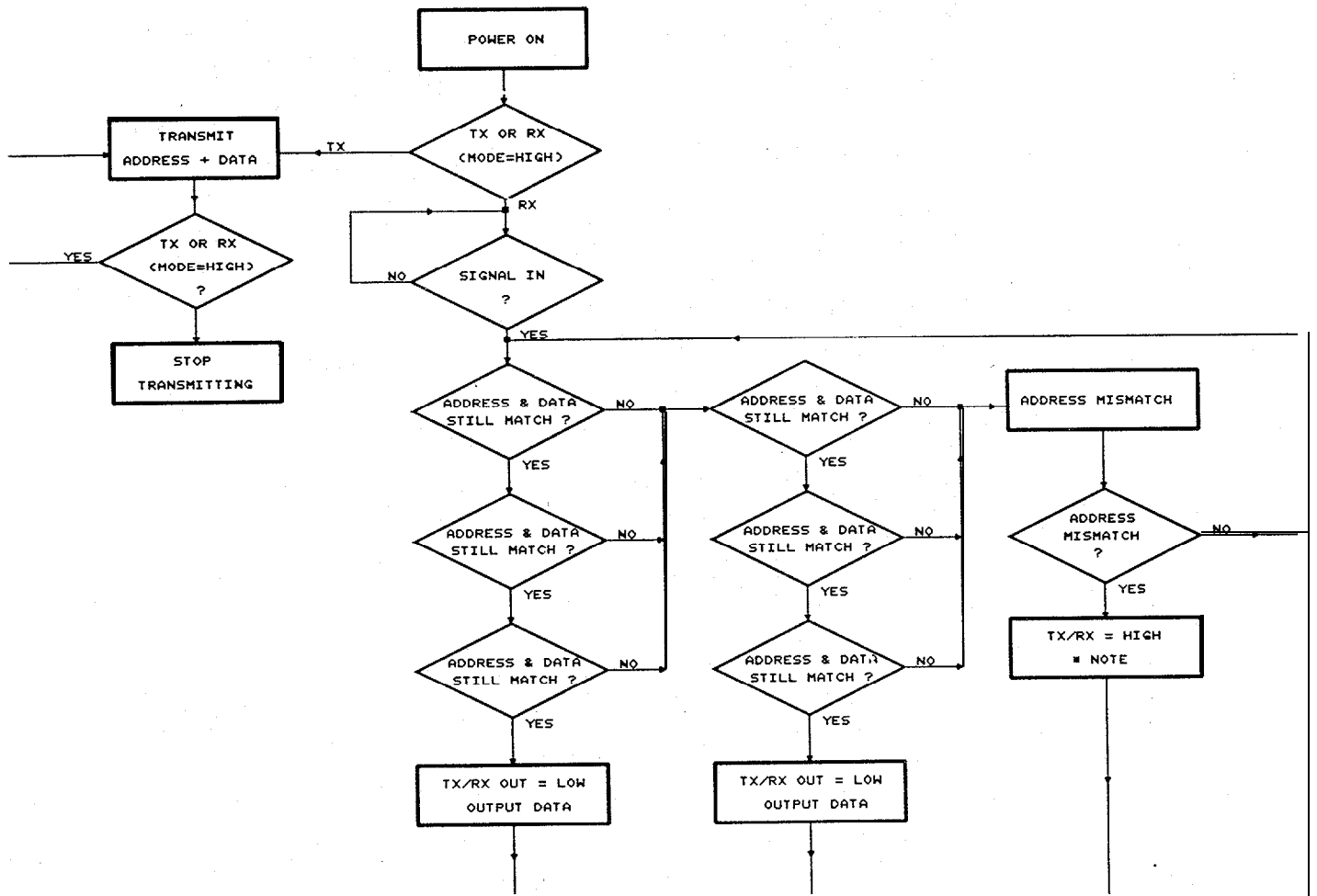

Fig. 3 -2

**UM3758 Operation Flowchart (without data bit)**

**UM3758 Operation Flowchart (with data bit)**

\* Note : For LATCH Type ————— Keep current data  
 For MOMENTARY Type ——— All Data fall to LOW

\* Address MISMATCH INCLUDES " NO SIGNAL IN ".

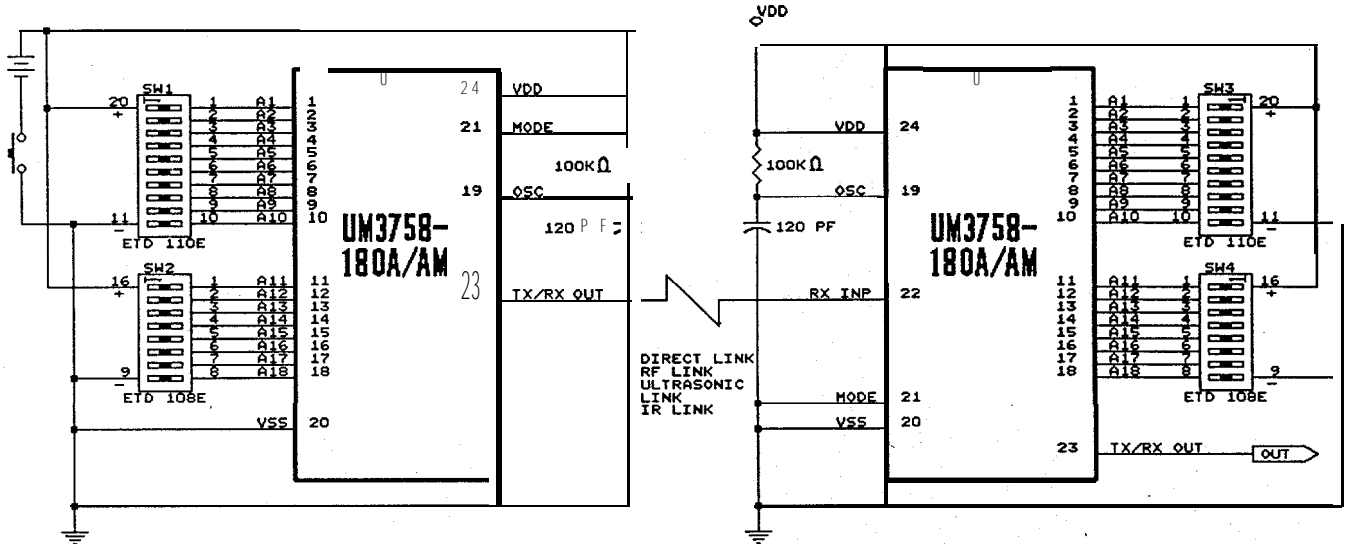
**Application Circuit (without data bit)**

**Application Circuits (with data bit)**

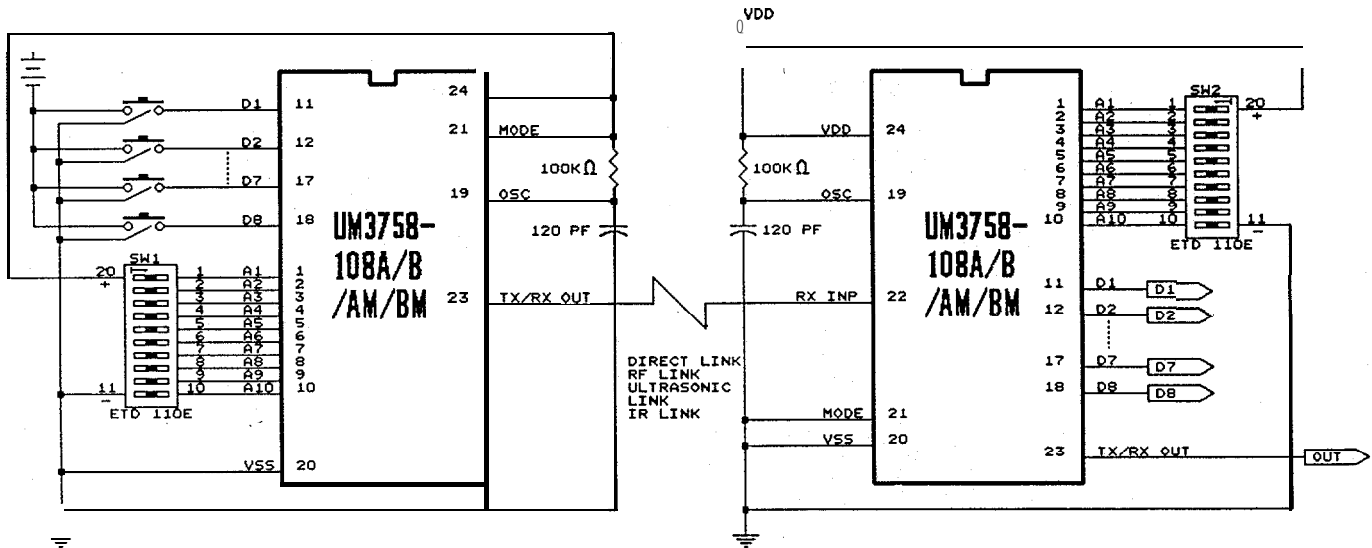
(A) Use Three-Contact Pushbutton



Note: ETD 108E — 8-Pin Tri-State DIP switch made by EXCEL CELL ELECTRONIC CO., LTD. IN TAIWAN R.O.C.

ETD 110E — 10-Pin Tri-State DIP switch made by EXCEL CELL ELECTRONIC CO., LTD. IN TAIWAN R.O.C.

## Application Circuits (Continued)

## (B) Use Normal Two-Contact Pushbutton

## (B) — 1 Application Circuit with Data Bit High to Low

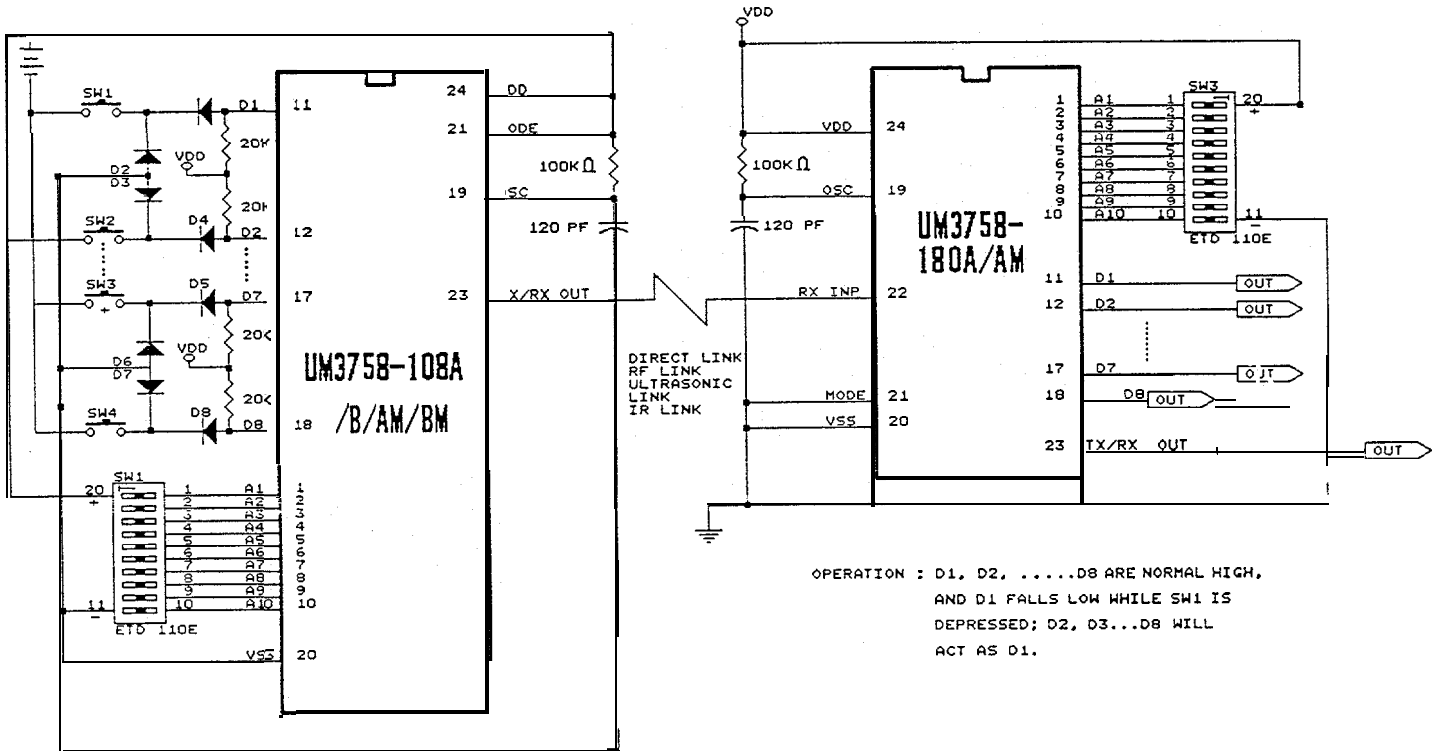

## (B) — 2 Application Circuit with Data Bit Low to High

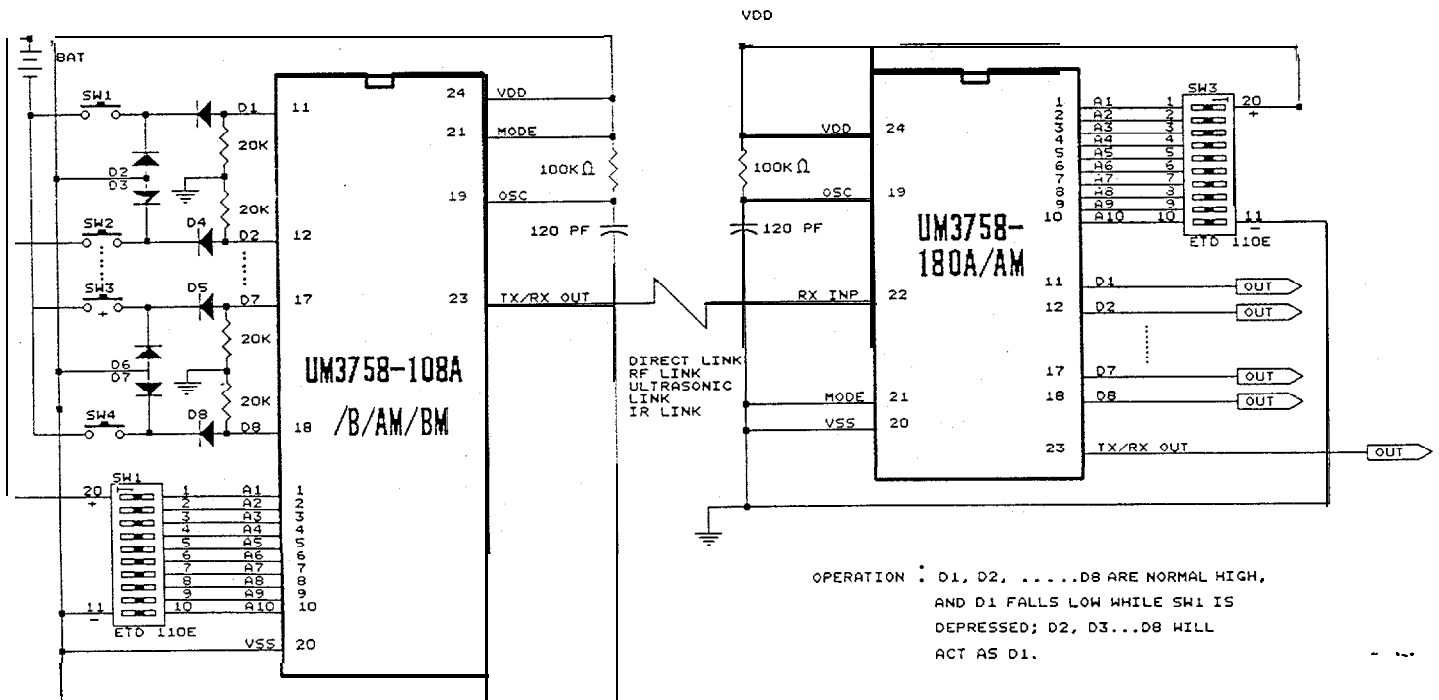

**Ordering Information**

Part No.	Addresses	Data	Data Output Type	Package Type
UM3758-180A	18	0	—	24L DIP
UM3758-180AM	18	0	—	24L SOP
UM37581 08A	10	8	LATCHED	24L DIP
UM3758-108AM	10	8	LATCHED	24L SOP
UM3758-108B	10	8	MOMENTARY	24L DIP
UM3758-108BM	10	8	MOMENTARY	24L SOP
UM3758-120A	12	0	—	18L DIP
UM3758-120AM	12	0	—	20L SOP
UM3758-084A	8	4	LATCHED	18LDIP
UM3758-084AM	8	4	LATCHED	20L SOP
UM3758-084B	8	4	MOMENTARY	18LDIP
UM3758-084BM	8	4	MOMENTARY	20L SOP

**Package Information**
**DIP 24L Outline Dimensions**

unit : inch/mm

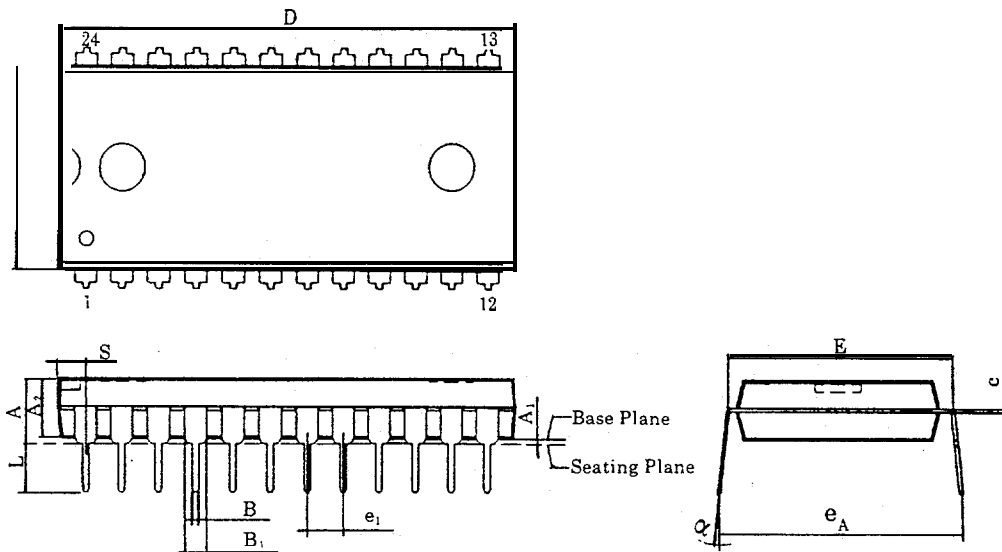

Symbol	Dimensions in inch	Dimensions in mm
A	0.210 Max.	5.33
A <sub>1</sub>	0.010 Min.	0.25 Min.
A <sub>2</sub>	0.155 ± 0.010	3.94 ± 0.25
B	0.018 <sup>+0.004</sup> -0.002	0.46 <sup>+0.10</sup> -0.05
B <sub>1</sub>	0.060 <sup>+0.004</sup> -0.002	1.52 <sup>+0.10</sup> -0.05
c	0.010 <sup>+0.004</sup> -0.002	0.25 <sup>+0.10</sup> -0.05
D	1 250TYP (1.270Max.)	31.75TYP (32.26Max.)
E	0.600 ± 0.010	15.24 ± 0.25
E <sub>1</sub>	0.550TYP (0.562Max.)	13.97TYP (14.27Max.)
e <sub>1</sub>	0.100 ± 0.010	2.54 ± 0.25
L	0.130 ± 0.010	3.30 ± 0.25
α	0°~15°	0°~15°
e <sub>A</sub>	0.655~0.035	16.64 ± 0.89
S	0.090 Max	2.29 Max.

**Note:**

1. The max value of dimension D includes end flash
2. The dimension E<sub>1</sub> doesn't include resin fins.
3. The dimension S includes end flash.
4. All dimensions are based on British system.

**Package Information**
**SOP 24L Outline Dimensions**

unit : inch/mm

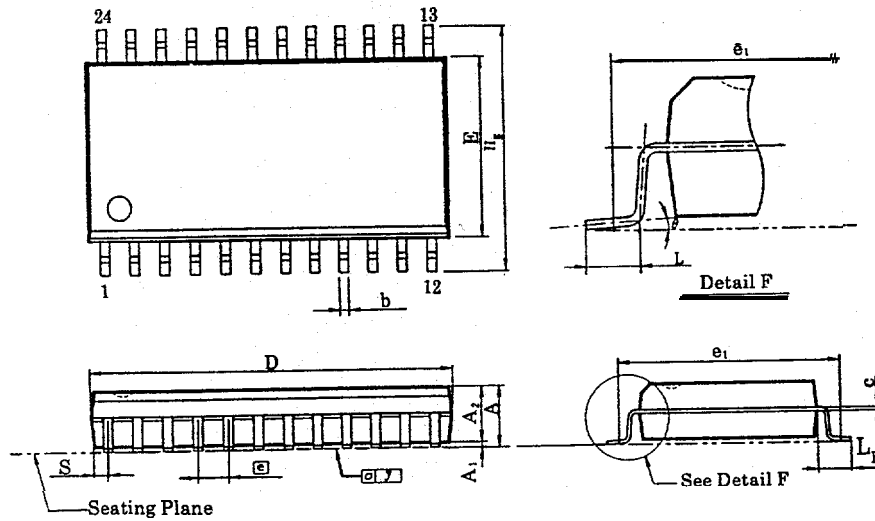

Symbol	Dimensions in inch	Dimensions in mm
A	0.110 Max.	2.79 Max.
A <sub>1</sub>	0.004 Min.	0.10 Min.
A <sub>2</sub>	0.091 ± 0.005	2.31 ± 0.13
b	0.016 <sup>+0.004</sup> / <sub>-0.002</sub>	0.41 <sup>+0.10</sup> / <sub>-0.05</sub>
c	0.006 <sup>+0.004</sup> / <sub>-0.002</sub>	0.15 <sup>+0.10</sup> / <sub>-0.05</sub>
D	0.606TYP (0.620Max.)	15.39TYP (15.75Max.)
F	0.295 ± 0.010	7.49 ± 0.25
$\bar{e}$	0.050 ± 0.006	1.27 ± 0.15
e <sub>1</sub>	0.370 NOM	9.40 NOM
HE	0.406 ± 0.012	10.31 ± 0.31
t	0.036 ± 0.008	0.91 ± 0.20
L <sub>E</sub>	0.055 ± 0.006	1.40 ± 0.20
S	0.040 Max.	1.02 Max.
Y	0.006 Max.	0.15 Max.
θ	0°~10°	0°~10°

**Note:**

1. The max value of dimension D includes end flash.
2. The dimension E doesn't include resin fins.
3. The dimension e<sub>1</sub> is for PC Board surface mount pad pitch design reference only.
4. The dimension S includes end flash.
5. All dimensions are based on British system.

**Package Information**
**DIP 18L Outline Dimensions**

unit : inch/mm

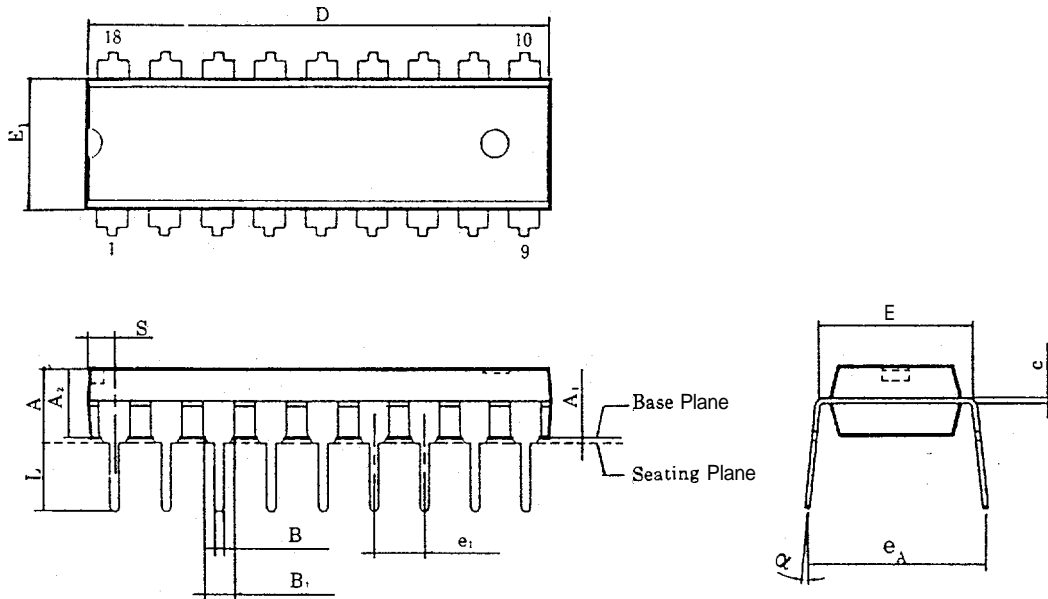

Symbol	Dimensions in inch	Dimensions in mm
A	0.175 Max.	4.45 Max.
A <sub>1</sub>	0.010 Min.	0.25 Min.
A <sub>2</sub>	0.130 ± 0.010	3.30 ± 0.25
B	0.018 $\pm$ $\begin{matrix} 0.004 \\ -0.002 \end{matrix}$	0.46 $\begin{matrix} +0.10 \\ -0.05 \end{matrix}$
B <sub>1</sub>	0.060 $\begin{matrix} +0.004 \\ -0.002 \end{matrix}$	1.52 $\begin{matrix} +0.10 \\ -0.05 \end{matrix}$
C	0.010 $\begin{matrix} +0.004 \\ -0.002 \end{matrix}$	0.25 $\begin{matrix} +0.10 \\ -0.05 \end{matrix}$
D	0.900TYP (0.920Max.)	22.86TYP (23.37Max.)
E	0.300 ± 0.010	7.62 ± 0.25
E <sub>1</sub>	0.250TYP (0.262Max.)	6.35TYP (6.65Max.)
e <sub>1</sub>	0.100 ± 0.010	2.54 ± 0.25
L	0.130 ± 0.010	3.30 ± 0.25
α	0°~15°	0°~15°
e <sub>A</sub>	0.345 ± 0.035	8.76 ± 0.89
S	0.055 Max.	1.40 Max.

**Note:**

1. The max value of dimension D includes end flash.
2. The dimension E<sub>1</sub> doesn't include resin fins.
3. The dimension S includes end flash.
4. All dimensions are based on British system.



**Package Information**
**SOP 20L Outline Dimensions**

unit : inch/mm

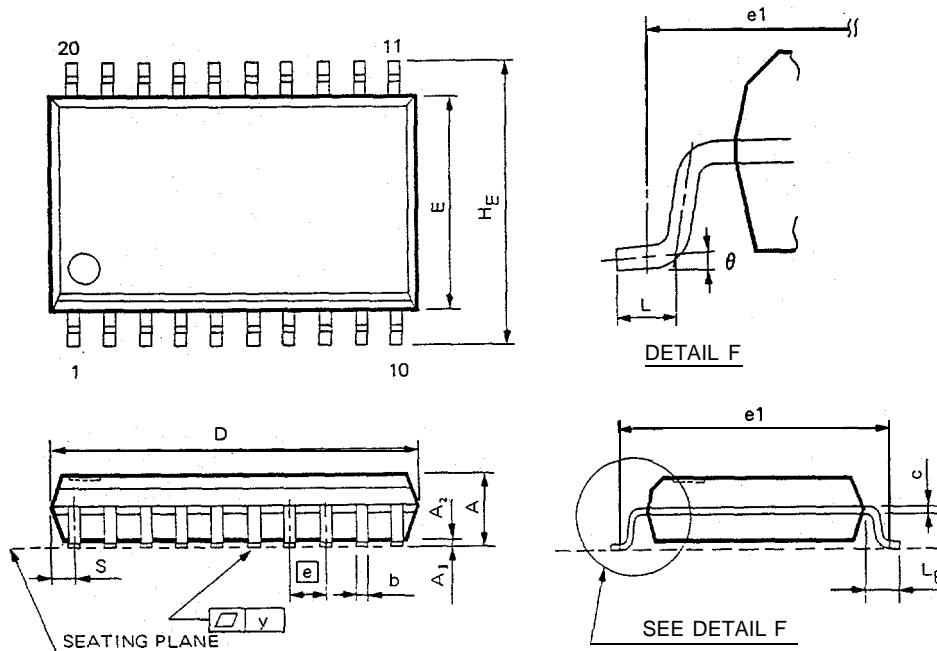

Symbol	Dimensions in inch	Dimensions in mm
A	0.106 Max	2.69 Max
A1	0.004 Min	0.10 Min
A2	0.092 ± 0.005	2.33 ± 0.13
b	0.016 <sup>+0.004</sup> -0.002	0.41 <sup>+0.10</sup> -0.05
c	0.010 <sup>+0.004</sup> -0.002	0.25 <sup>+0.10</sup> -0.05
D	0.504 TYP (0.524 Max)	12.80 TYP (13.31 Max)
E	0.295 ± 0.010	7.49 ± 0.25
e	0.050 ± 0.006	1.27 ± 0.15
e <sup>1</sup>	0.374 NOM	9.50 NOM
H <sub>E</sub>	0.406 ± 0.012	10.31 ± 0.31
L	0.032 ± 0.008	0.81 ± 0.20
L <sub>E</sub>	0.055 ± 0.008	1.40 ± 0.20
s	0.042 Max	1.07 Max
v	0.006 Max.	0.15 Max
θ	0° ~ 10°	0° ~ 10°

**Note:**

1. The max value of dimension D includes end flash.
2. The dimensions E doesn't include resin fins.
3. The dimension e<sup>1</sup> is for PC Board surface mount pad pitch design reference only.
4. The dimension S includes end flash
5. All dimensions are based on British system.



**Notice:** The information appearing in this publication is believed to be accurate. Integrated circuits sold by UMC are covered by the warranty and patent indemnification provisions stipulated in the terms of sale only. UMC makes no warranty, expressed, statutory, implied or by description regarding the information in this publication or regarding the freedom of the described chip from patent infringement. Furthermore, UMC makes no warranty of merchantability or fitness for any purpose. UMC reserves the right to halt production or alter specifications and prices at any time without notice. Accordingly, the reader is cautioned to verify that the data sheets and other information in this publication are current before placing orders.

**Products** described herein are intended for use in normal commercial applications. Applications which require extended temperature range, unusual environmental requirements, or high reliability applications, e.g. military, medical life-support or life sustaining equipment, are specifically not recommended without additional processing by UMC for such applications. Also, please note that Application Circuits in this document are for reference purposes only.

UMC has no sales or Service functions in the U.S.A. and therefore does not intend to sell its products in this market.