



# Part 15C

# TEST REPORT

<b>Product Name</b>	Wi-Fi Internet of Things Module
<b>Model</b>	ESP8266EX
<b>Brand Name</b>	WROOM
<b>FCC ID</b>	2AC7Z-ESP8266EX
<b>Applicant</b>	ESPRESSIF SYSTEMS (SHANGHAI) PTE LTD
<b>Manufacturer</b>	ESPRESSIF SYSTEMS (SHANGHAI) PTE LTD
<b>Date of issue</b>	October 28, 2014

**TA Technology (Shanghai) Co., Ltd.**

**TA Technology (Shanghai) Co., Ltd.**  
**Test Report**

Report No.: RXA1409-0216RF01R1

Page 2 of 96

**GENERAL SUMMARY**

<b>Reference Standard(s)</b>	<p><b>FCC CFR47 Part 15C (2013)</b> Radio Frequency Devices</p> <p><b>15.205</b> Restricted bands of operation;</p> <p><b>15.207</b> Conducted limits;</p> <p><b>15.209</b> Radiated emission limits; general requirements;</p> <p><b>15.247</b> Operation within the bands 902-928 MHz, 2400-2483.5 MHz, and 5725-5850MHz.</p> <p><b>ANSI C63.4</b> Methods of Measurement of Radio-Noise Emission from Low-Voltage Electrical and Electronic Equipment in the Range of 9 KHz to 40GHz. (2009)</p> <p><b>KDB 558074 D01 DTS Meas Guidance v03r01</b> Guidance for Performing Compliance Measurements on Digital Transmission Systems (DTS) Operating Under §15.247</p>
<b>Conclusion</b>	<p>This wireless equipment has been measured in all cases requested by the relevant standards. Test results in Chapter 2 of this test report are below limits specified in the relevant standards.</p> <p>General Judgment: <b>Pass</b></p>
<b>Comment</b>	<p>The test result only responds to the measured sample.</p>

Approved by *Kai Xu*  
Kai Xu  
Director

Revised by *Lingling Kang*  
Lingling Kang  
RF Manager

Performed by *Changxu Wan*  
Changxu Wan  
RF Engineer

## TABLE OF CONTENT

1. General Information .....	4
1.1. Notes of the test report .....	4
1.2. Testing laboratory .....	5
1.3. Applicant Information .....	5
1.4. Manufacturer Information .....	5
1.5. Information of EUT .....	6
1.6. Test Date .....	6
2. Test Information .....	7
2.1. Test Mode .....	7
2.2. Summary of test results .....	8
2.3. Peak Power Output –Conducted.....	9
2.4. Occupied Bandwidth (6dB) .....	11
2.5. Band Edge Compliance .....	17
2.6. Spurious Radiated Emissions in the restricted band.....	21
2.7. Power Spectral Density.....	30
2.8. Spurious RF Conducted Emissions .....	36
2.9. Radiates Emission .....	47
2.10. Conducted Emissions .....	86
2. Main Test Instruments .....	93
ANNEX A: EUT Appearance and Test Setup.....	94
A.1 EUT Appearance .....	94
A.2 Test Setup .....	95

# TA Technology (Shanghai) Co., Ltd. Test Report

Report No.: RXA1409-0216RF01R1

Page 4 of 96

---

## 1. General Information

### 1.1. Notes of the test report

**TA Technology (Shanghai) Co., Ltd.** has obtained the accreditation of China National Accreditation Service for Conformity Assessment (CNAS), and accreditation number: L2264.

**TA Technology (Shanghai) Co., Ltd.** has been listed on the US Federal Communications Commission list of test facilities recognized to perform electromagnetic emissions measurements. The site recognition number is 428261.

**TA Technology (Shanghai) Co., Ltd.** has been listed by industry Canada to perform electromagnetic emission measurement. The site recognition number is 8510A.

**TA Technology (Shanghai) Co., Ltd.** guarantees the reliability of the data presented in this test report, which is the results of measurements and tests performed for the items under test on the date and under the conditions stated in this test report and is based on the knowledge and technical facilities available at TA Technology (Shanghai) Co., Ltd. at the time of execution of the test.

**TA Technology (Shanghai) Co., Ltd.** is liable to the client for the maintenance by its personnel of the confidentiality of all information related to the items under test and the results of the test. The sample under test was selected by the Client. This report only refers to the item that has undergone the test.

This report alone does not constitute or imply by its own an approval of the product by the certification Bodies or competent Authorities. This report cannot be used partially or in full for publicity and/or promotional purposes without previous written approval of **TA Technology (Shanghai) Co., Ltd.** and the Accreditation Bodies, if it applies.

If the electronic report is inconsistent with the printed one, it should be subject to the latter.

# TA Technology (Shanghai) Co., Ltd. Test Report

Report No.: RXA1409-0216RF01R1

Page 5 of 96

---

## 1.2. Testing laboratory

Company: TA Technology (Shanghai) Co., Ltd.  
Address: No.145, Jintang Rd, Tangzhen Industry Park, Pudong  
City: Shanghai  
Post code: 201201  
Country: P. R. China  
Contact: Xu Kai  
Telephone: +86-021-50791141/2/3  
Fax: +86-021-50791141/2/3-8000  
Website: <http://www.ta-shanghai.com>  
E-mail: [xukai@ta-shanghai.com](mailto:xukai@ta-shanghai.com)

## 1.3. Applicant Information

Company: ESPRESSIF SYSTEMS (SHANGHAI) PTE LTD  
Address: 456 Bibo Road Room A201, 201203, Shanghai/China

## 1.4. Manufacturer Information

Company: ESPRESSIF SYSTEMS (SHANGHAI) PTE LTD  
Address: 456 Bibo Road Room A201, 201203, Shanghai/China

# TA Technology (Shanghai) Co., Ltd.

## Test Report

### 1.5. Information of EUT

#### General information

SN:	8266EX2120141
Hardware Version:	HW V1.0
Software Version:	SW V1.0
Antenna Type:	Dedicated Antennas
Device Operating Configurations:	
Test Function:	802.11b, 802.11g, 802.11n HT20
Test Modulation:	(802.11b)DSSS; (802.11g)OFDM; 802.11n OFDM
Max Conducted Power	24.25 dBm
Operating Frequency Range(s)	2412MHz~ 2462MHz
Tested Frequency Range(s)	2400MHz~ 2483.5 MHz

#### Dedicated Antenna

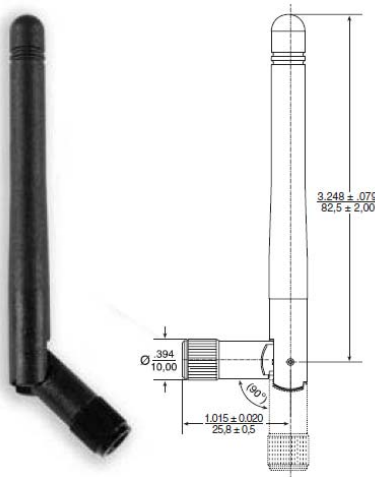

#### Features

- Shortest antennas in product line
- For WLAN devices using WiFi (802.11b/g), Bluetooth® and ZigBee™
- Omni-directional radiation pattern provides broad 360° coverage
- One-quarter wavelength dipole configuration
- Connection options easily integrate with OEM designs

#### Connector

- Reverse SMA (Male)\*
- SMA (Male)

*\* Default Configuration - Please contact Pulse Applications Engineering for assistance in ordering connectors*

Weight . . . . . 6.3 grams  
 Carton . . . . . 20/bag, 500/carton

Dimensions [in / mm]

Unless otherwise specified, all tolerances are ± .010 / 0.25

### 1.6. Test Date

The test is performed from October 13, 2014 to October 20, 2014.

# TA Technology (Shanghai) Co., Ltd.

## Test Report

## 2. Test Information

### 2.1. Test Mode

The EUT has been associated with peripherals and configuration operated in a manner tended to maximize its emission characteristics in a typical application.

The radiated emission was measured in the following position: EUT stand-up position (Z axis), lie-down position (X, Y axis). The worst emission was found in lie-down position (X axis) and the worst case was recorded.

In order to find the worst case condition, Pre-tests are needed at the presence of different data rate declared in basic standard IEEE802.11. Preliminary tests has been done on all the configuration for confirming worst case. Data rate below means worst-case rate of each test item.

Results of test modes, data rates and test channels are shown as following table.

	Test items	Modes	Data Rate	Test channel
Conducted Test cases	Peak Power Output –Conducted	802.11b	11 Mbps	1/6/11
		802.11g	6 Mbps	1/6/11
		802.11n(HT20)	MCS0	1/6/11
	Minimum 6dB bandwidth	802.11b	11 Mbps	1/6/11
		802.11g	6 Mbps	1/6/11
		802.11n(HT20)	MCS0	1/6/11
	Band Edges compliance	802.11b	11 Mbps	1/11
		802.11g	6 Mbps	1/11
		802.11n(HT20)	MCS0	1/11
	Power spectral Density	802.11b	11 Mbps	1/6/11
		802.11g	6 Mbps	1/6/11
		802.11n(HT20)	MCS0	1/6/11
	Conducted Spurious Emission	802.11b	11 Mbps	1/6/11
		802.11g	6 Mbps	1/6/11
		802.11n(HT20)	MCS0	1/6/11
Conducted Emissions	802.11b	11 Mbps	6	
	802.11g	6 Mbps	6	
	802.11n(HT20)	MCS0	6	
Radiated Test cases	Spurious Radiated Emissions in the restricted band	802.11b	11 Mbps	1/11
		802.11g	6 Mbps	1/11
		802.11n(HT20)	MCS0	1/11
	Radiates Emission	802.11b	11 Mbps	1/6/11
		802.11g	6 Mbps	1/6/11
		802.11n(HT20)	MCS0	1/6/11

**TA Technology (Shanghai) Co., Ltd.**  
**Test Report**

Report No.: RXA1409-0216RF01R1

Page 8 of 96

**2.2. Summary of test results**

<b>Number</b>	<b>Summary of measurements of results</b>	<b>Clause in FCC rules</b>	<b>Verdict</b>
1	Peak Power Output –Conducted	15.247(b)(3)	PASS
2	Minimum 6dB bandwidth	15.247(a)(2)	PASS
3	Band Edges compliance	15.247(d)	PASS
4	Spurious Radiated Emissions in the restricted band	15.247(d),15.205,15.209	PASS
5	Power spectral Density	15.247(e)	PASS
6	Conducted Spurious Emission	15.247	PASS
7	Radiates Emission	15.247(d),15.205,15.209	PASS
8	Conducted Emissions	15.207,15.107	PASS



### 2.3. Peak Power Output –Conducted

#### Ambient condition

Temperature	Relative humidity	Pressure
23°C ~ 25°C	45% ~ 50%	101.5kPa

#### Methods of Measurement

During the process of the testing, The EUT was connected to the peak power meter through an external attenuator and a known loss cable. The EUT is max power transmission with proper modulation. We use 5.2.1 Maximum Peak Conducted Output Power Level Method in KDB 558074 D01 for this test.

#### Test Setup

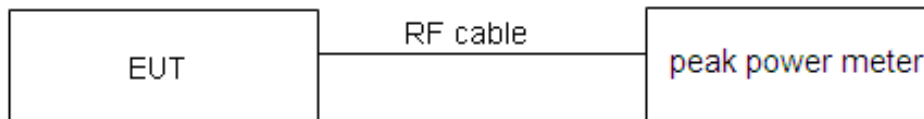

#### Limits

Rule Part 15.247 (b) (3) specifies that " For systems using digital modulation in the 902–928 MHz, 2400–2483.5 MHz, and 5725–5850 MHz bands: 1 Watt."

Peak Output Power	$\leq 1\text{W}$ (30dBm)
-------------------	--------------------------

#### Measurement Uncertainty

The assessed measurement uncertainty to ensure 95% confidence level for the normal distribution is with the coverage factor  $k = 2$ ,  $U = 0.44$  dB.

**TA Technology (Shanghai) Co., Ltd.**  
**Test Report**

Report No.: RXA1409-0216RF01R1

Page 10 of 96

**Test Results:**

<b>Network Standards</b>	<b>Carrier frequency (MHz)</b>	<b>Peak Output Power (dBm)</b>	<b>Conclusion</b>
802.11b	2412	22.49	PASS
	2437	22.05	PASS
	2462	22.43	PASS
802.11g	2412	24.24	PASS
	2437	24.09	PASS
	2462	24.25	PASS
802.11n HT20	2412	23.76	PASS
	2437	23.90	PASS
	2462	24.22	PASS

# TA Technology (Shanghai) Co., Ltd.

## Test Report

Report No.: RXA1409-0216RF01R1

Page 11 of 96

### 2.4. Occupied Bandwidth (6dB)

#### Ambient condition

Temperature	Relative humidity	Pressure
23°C ~25°C	45%~50%	101.5kPa

#### Method of Measurement

The EUT was connected to the spectrum analyzer through an external attenuator (20dB) and a known loss cable. RBW is set to 100 kHz, VBW is set to 300 kHz on spectrum analyzer.

#### Test Setup

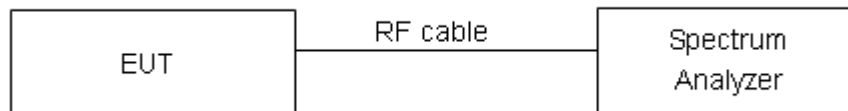

#### Limits

Rule Part 15.247 (a) (2) specifies that “Systems using digital modulation techniques may operate in the 902–928 MHz, 2400–2483.5 MHz, and 5725–5850 MHz bands. The minimum 6 dB bandwidth shall be at least 500 kHz.”

minimum 6 dB bandwidth	$\geq 500$ kHz
------------------------	----------------

#### Measurement Uncertainty

The assessed measurement uncertainty to ensure 95% confidence level for the normal distribution is with the coverage factor  $k = 2$ ,  $U = 936$  Hz.

# TA Technology (Shanghai) Co., Ltd. Test Report

**Test Results:**

Network Standards	Carrier frequency (MHz)	Minimum 6 dB bandwidth (MHz)	Conclusion
802.11b	2412	11.48	PASS
	2437	11.90	PASS
	2462	11.89	PASS
802.11g	2412	16.60	PASS
	2437	16.62	PASS
	2462	16.57	PASS
802.11n HT20	2412	17.83	PASS
	2437	17.82	PASS
	2462	17.84	PASS

802.11b

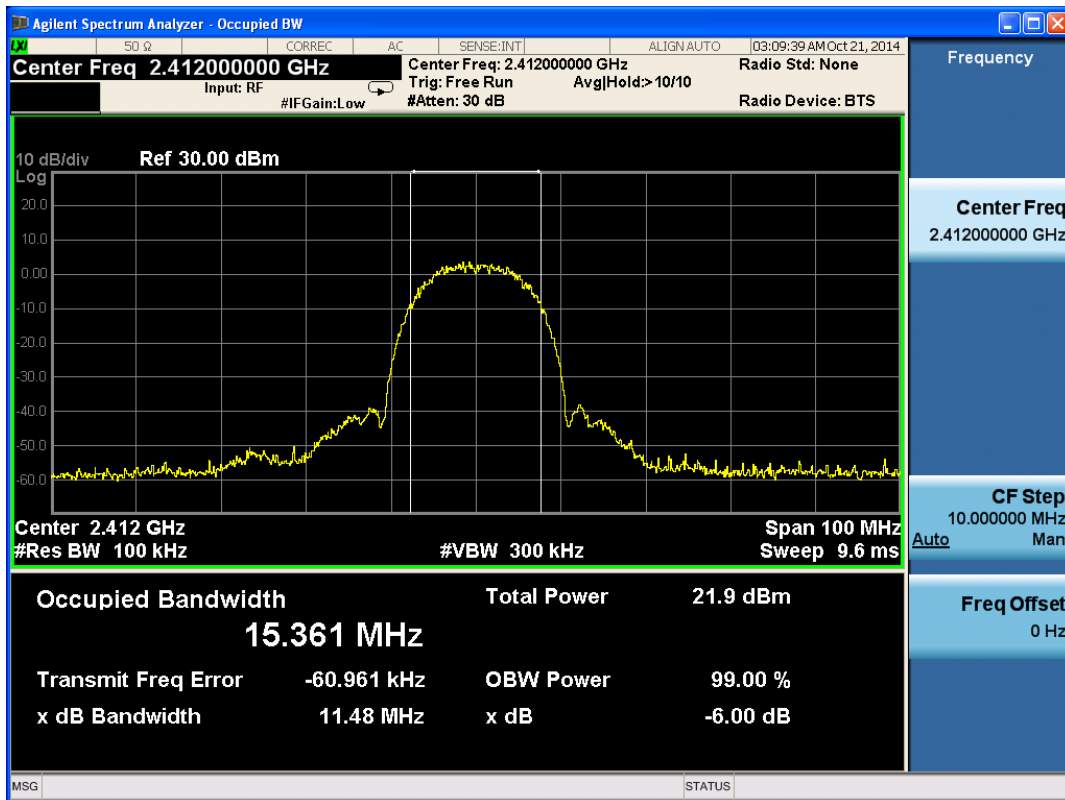

802.11b, Carrier frequency (MHz): 2412

# TA Technology (Shanghai) Co., Ltd. Test Report

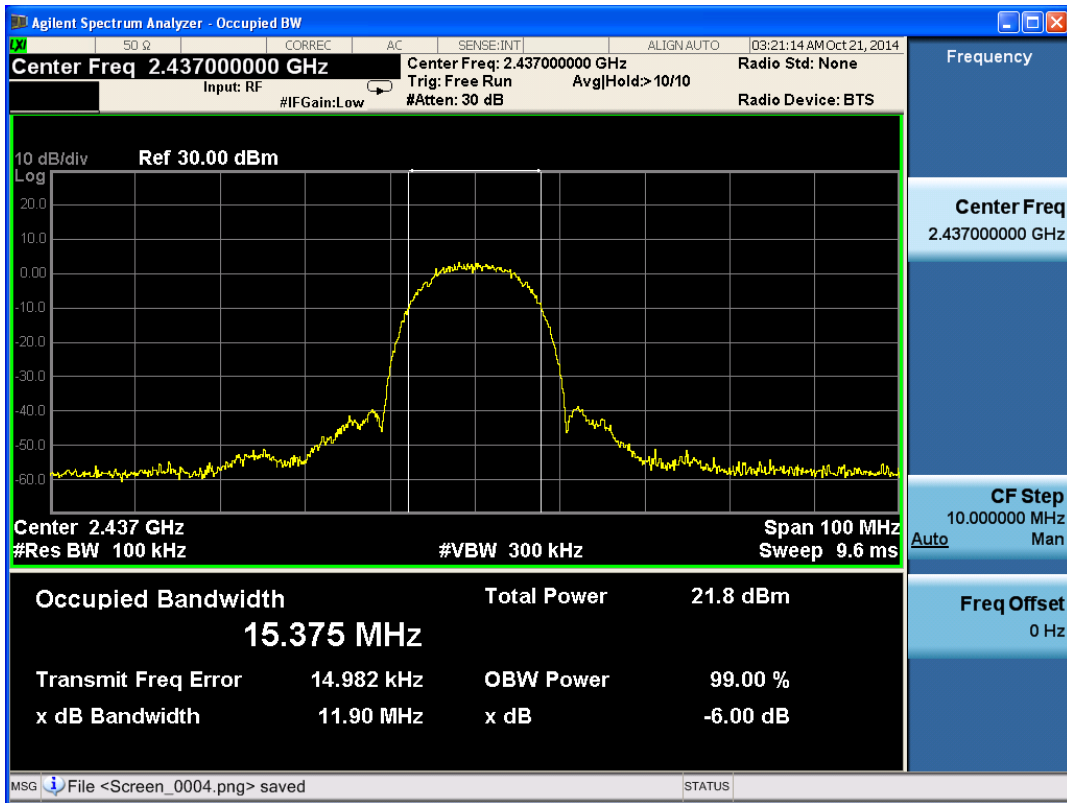

802.11b, Carrier frequency (MHz): 2437

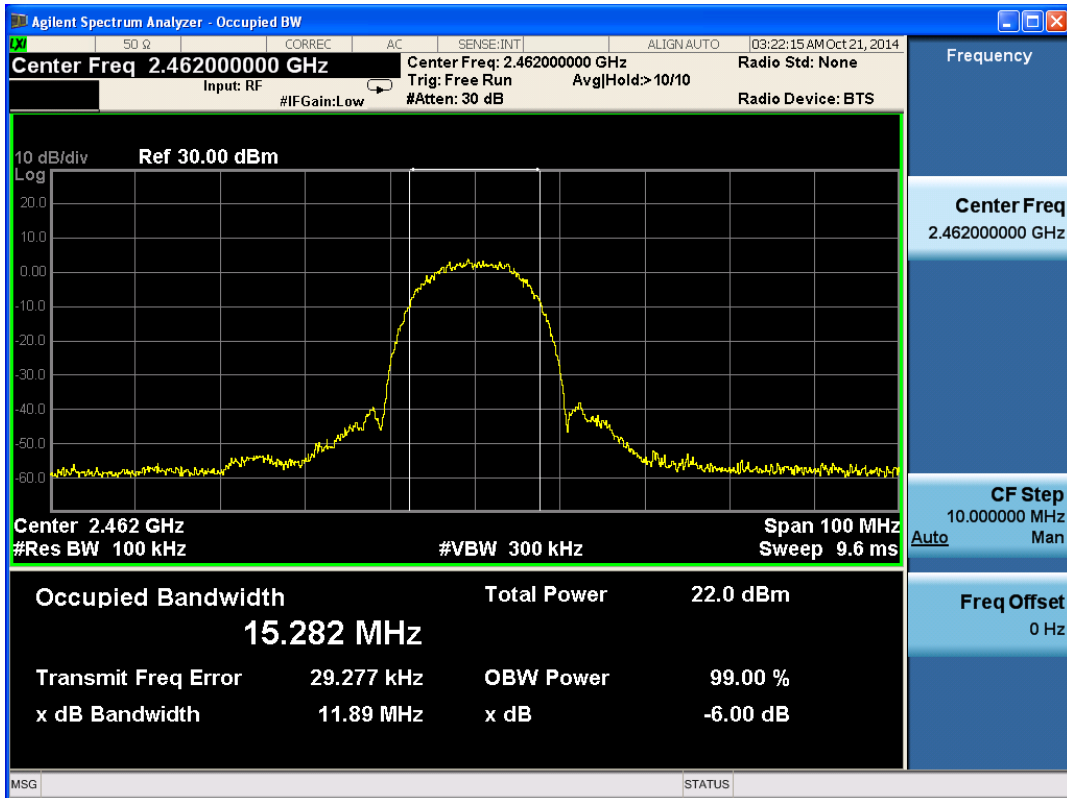

802.11b, Carrier frequency (MHz):2462

# TA Technology (Shanghai) Co., Ltd. Test Report

802.11g

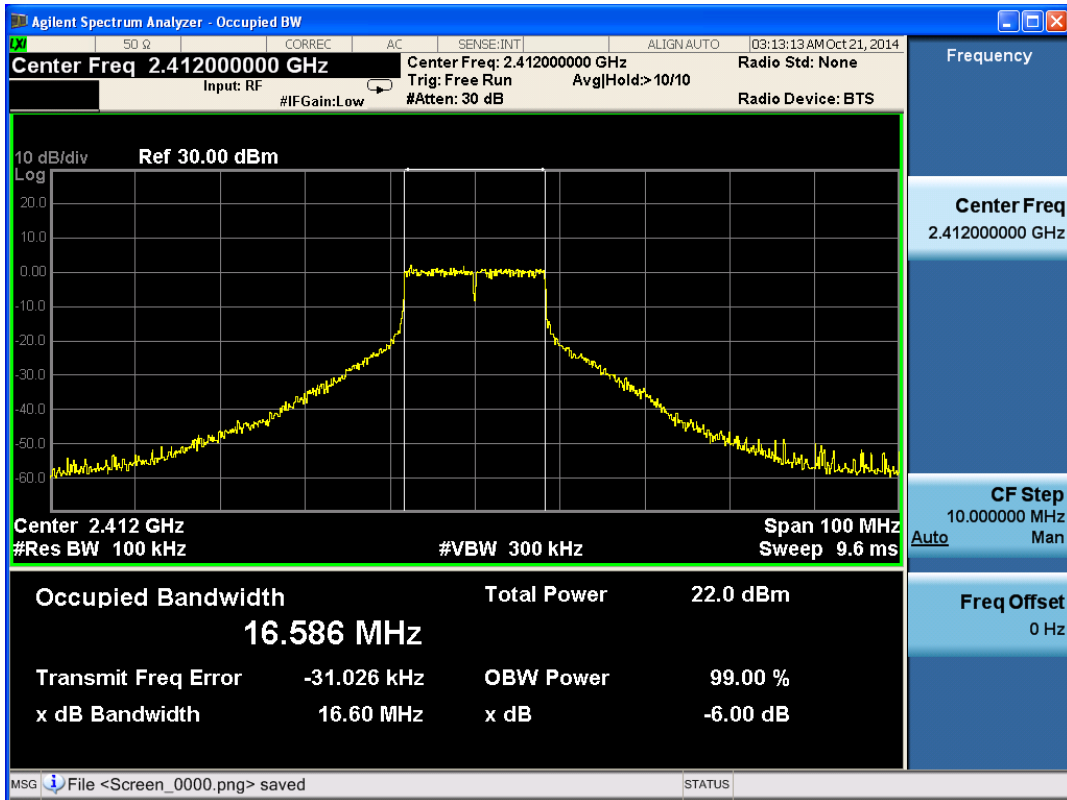

802.11g, Carrier frequency (MHz): 2412

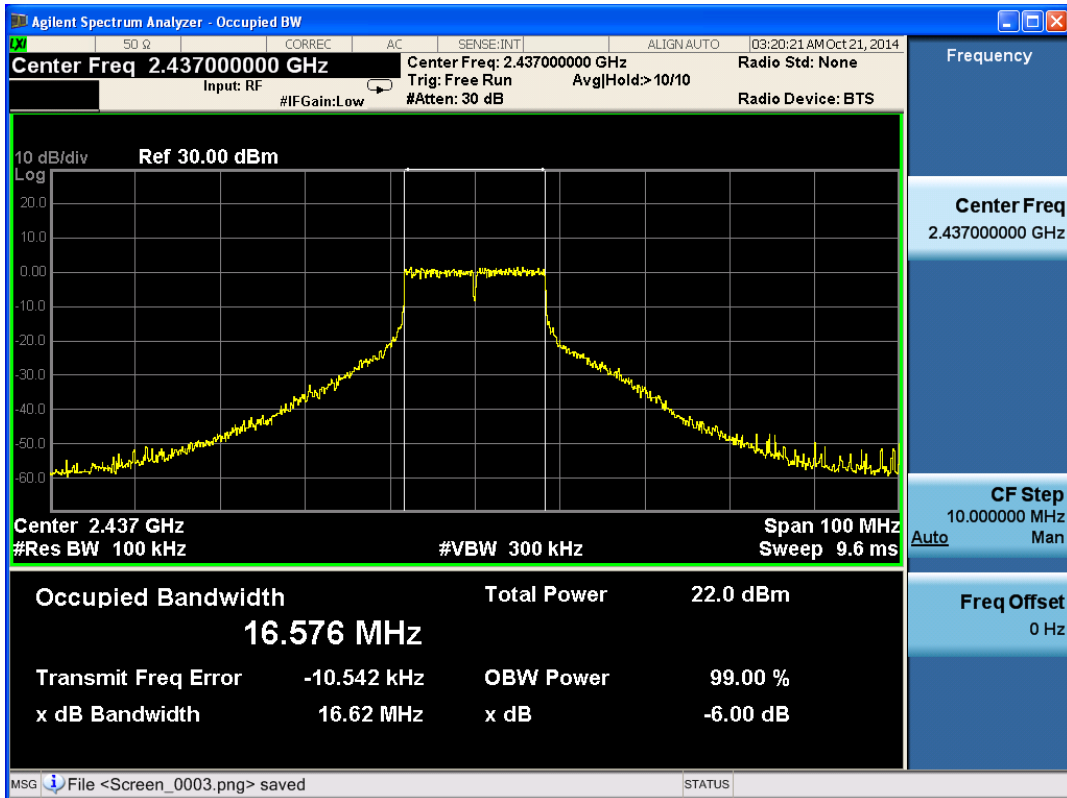

802.11g, Carrier frequency (MHz): 2437

# TA Technology (Shanghai) Co., Ltd. Test Report

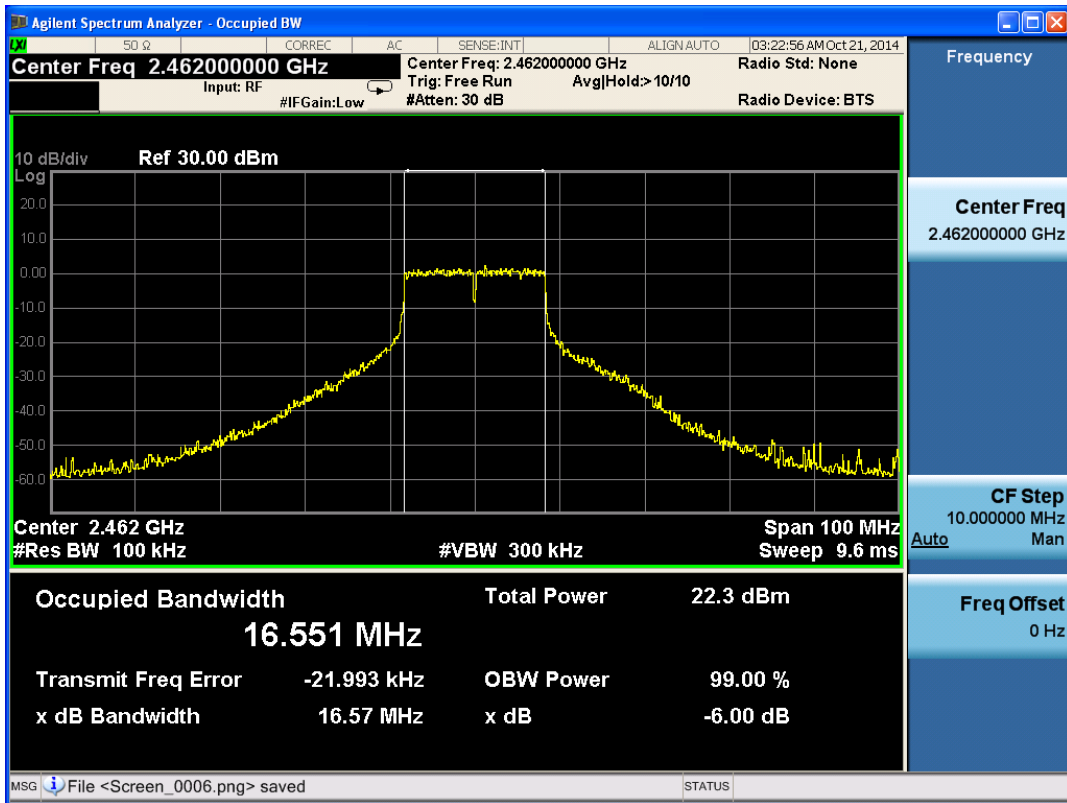

802.11g, Carrier frequency (MHz):2462

802.11n(HT20)

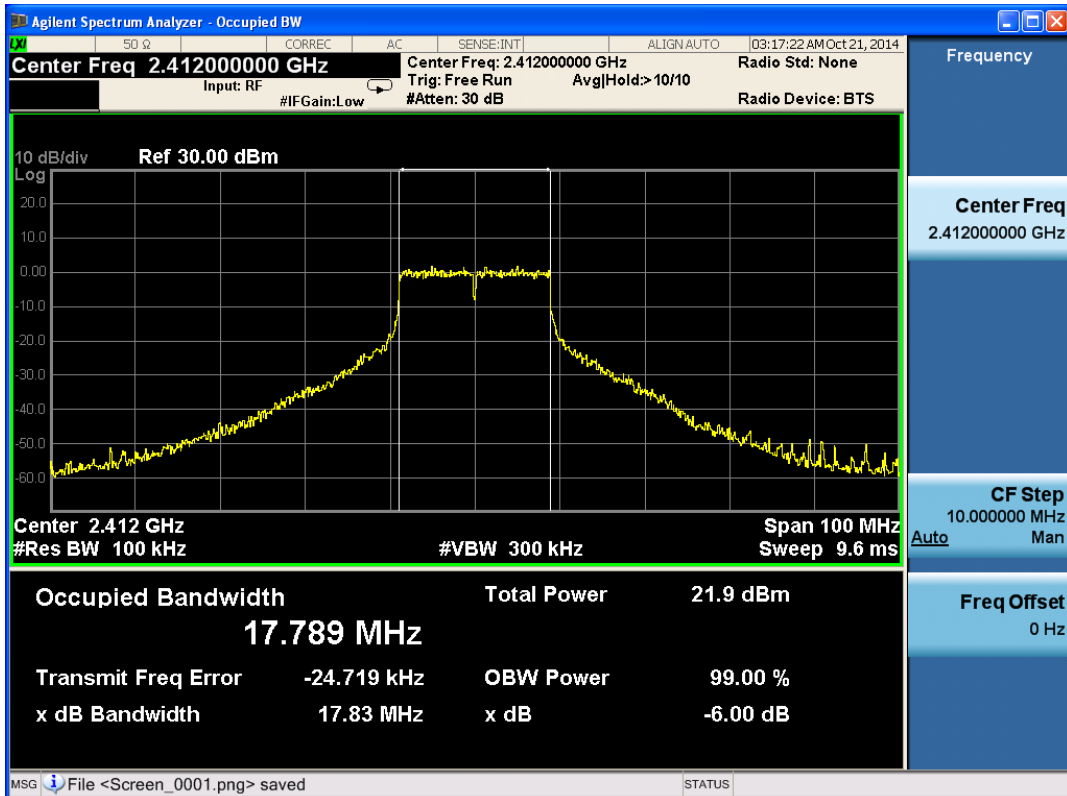

802.11n, Carrier frequency (MHz): 2412

# TA Technology (Shanghai) Co., Ltd. Test Report

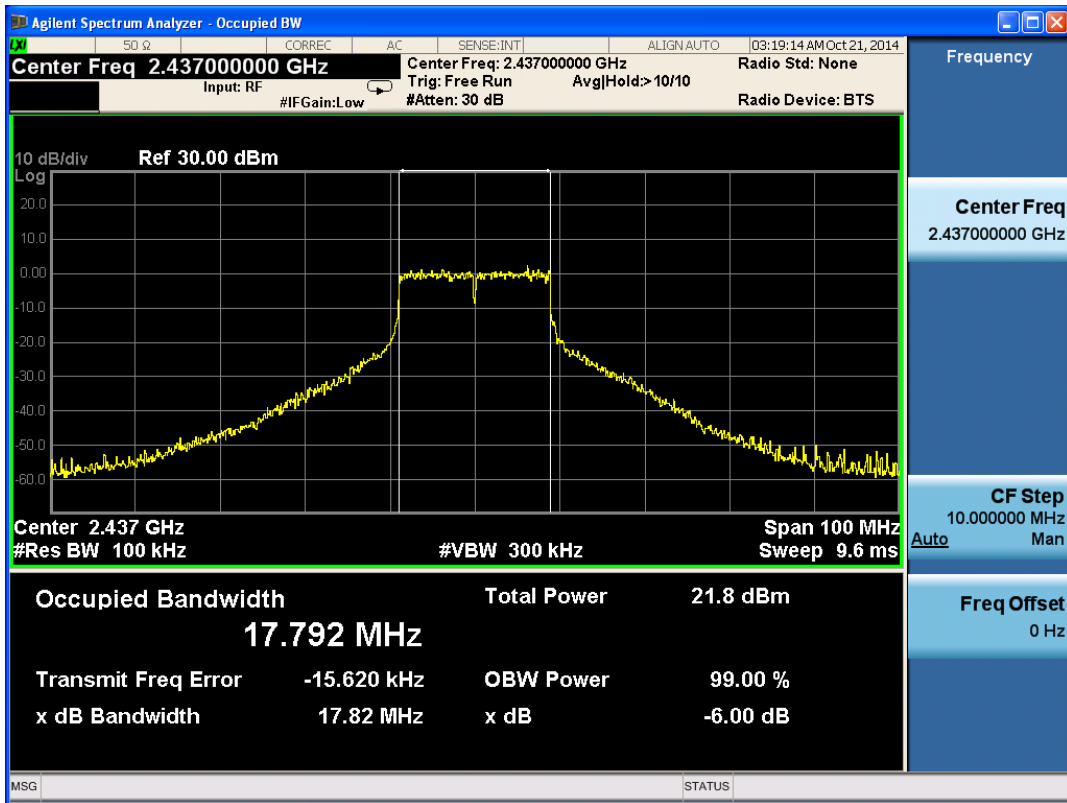

802.11n, Carrier frequency (MHz): 2437

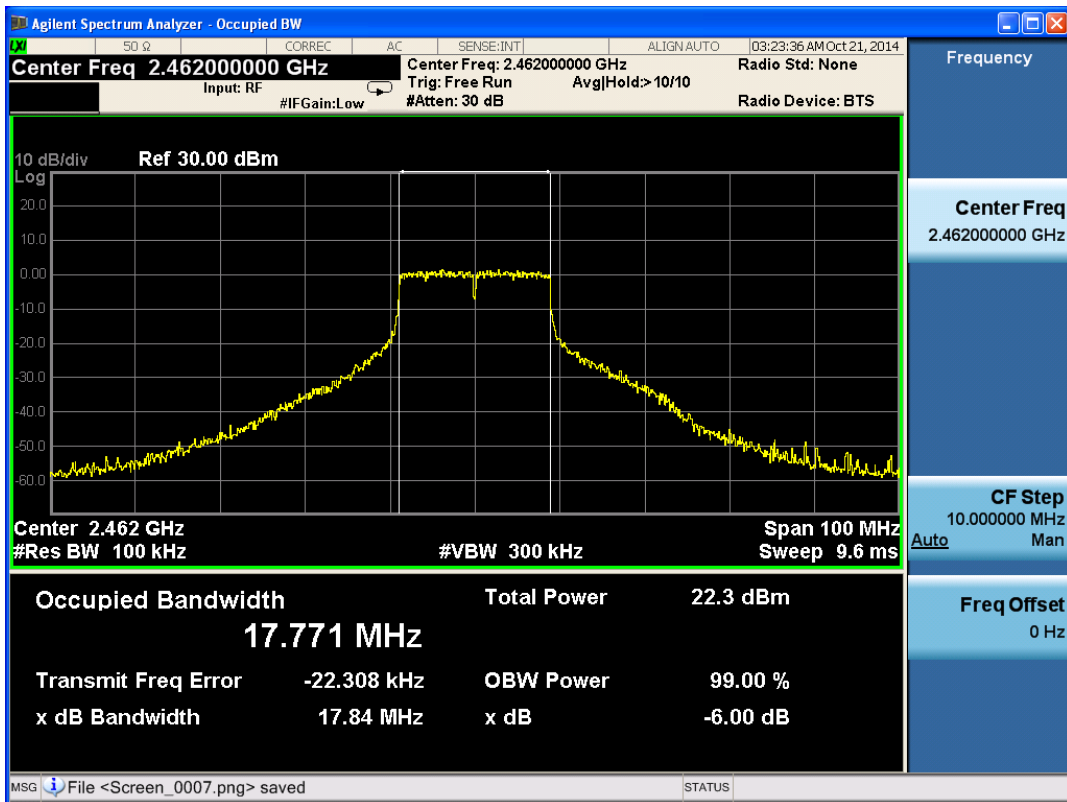

802.11n, Carrier frequency (MHz):2462



## 2.5. Band Edge Compliance

### Ambient condition

Temperature	Relative humidity	Pressure
23°C ~25°C	45%~50%	101.5kPa

### Method of Measurement

The EUT was connected to the spectrum analyzer through an external attenuator (20dB) and a known loss cable the band edge of the lowest and highest channels were measured. The peak detector is used and RBW is set to 100kHz and VBW is set to 300kHz on spectrum analyzer. Spectrum analyzer plots are included on the following pages.

### Test Setup

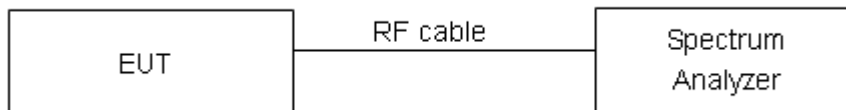

### Limits

Rule Part 15.247(d) specifies that “In any 100 kHz bandwidth outside the frequency band in which the spread spectrum or digitally modulated intentional radiator is operating, the radio frequency power that is produced by the intentional radiator shall be at least 20 dB below that in the 100 kHz bandwidth within the band that contains the highest level of the desired power, based on either an RF conducted or a radiated measurement.”

### Measurement Uncertainty

The assessed measurement uncertainty to ensure 95% confidence level for the normal distribution is with the coverage factor  $k = 1.96$ .

Frequency	Uncertainty
2GHz-3GHz	1.407 dB

# TA Technology (Shanghai) Co., Ltd. Test Report

Report No.: RXA1409-0216RF01R1

Page 18of 96

**Test Results: PASS**

802.11b

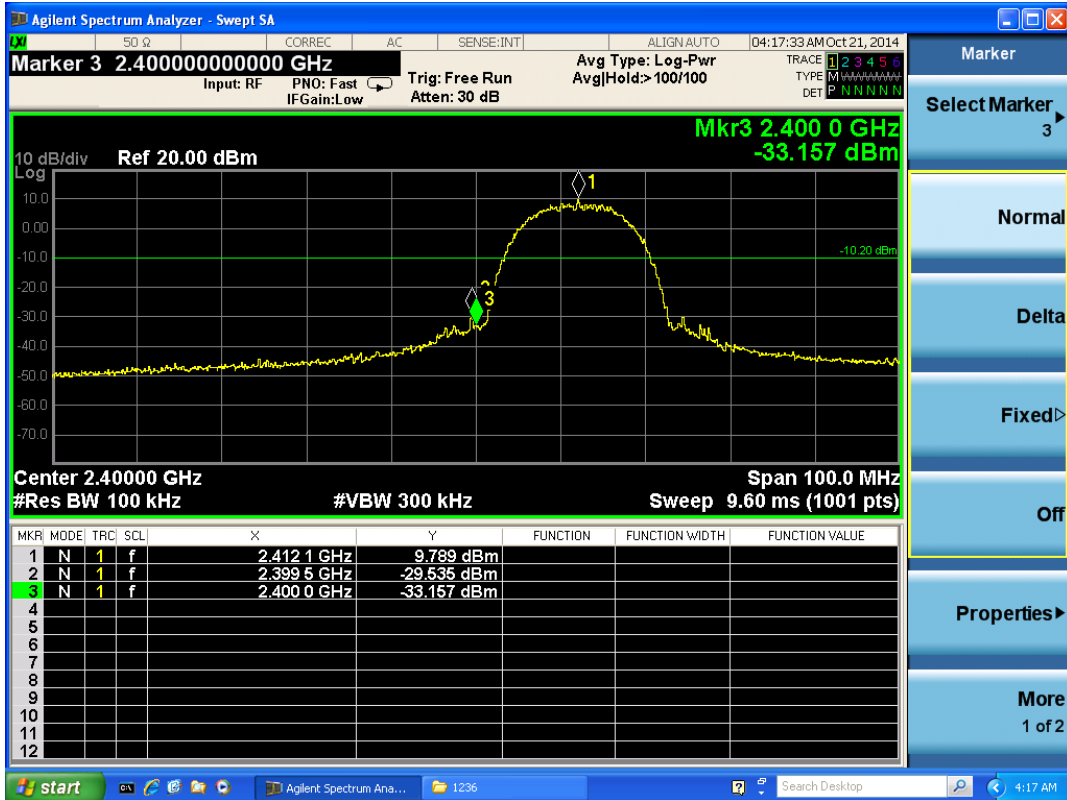

802.11b, Channel No.: 1

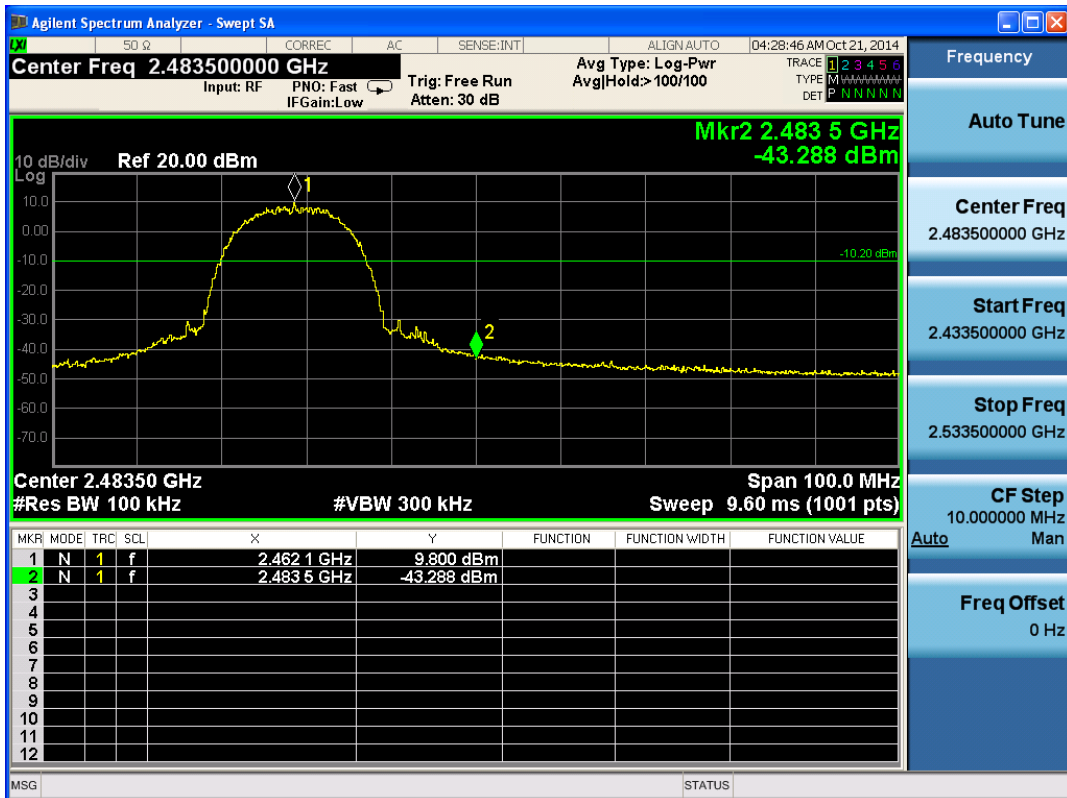

802.11b, Channel No.: 11

# TA Technology (Shanghai) Co., Ltd. Test Report

802.11g



802.11g, Channel No.: 1

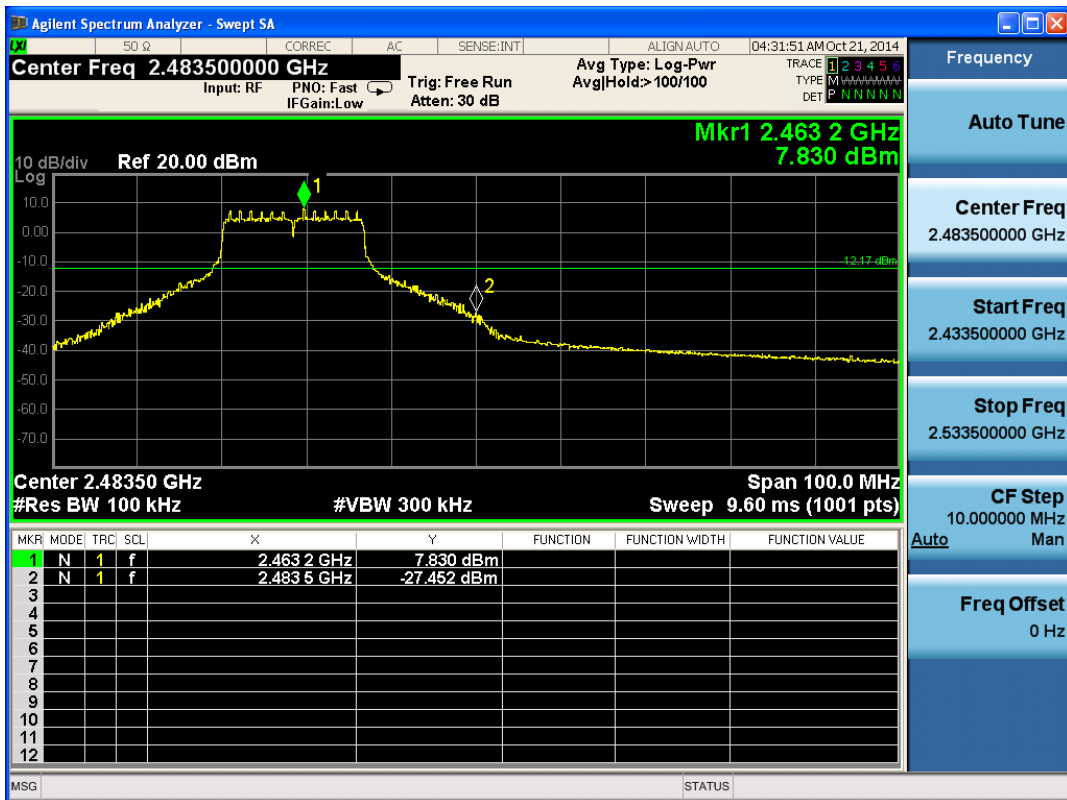

802.11g, Channel No.: 11

# TA Technology (Shanghai) Co., Ltd. Test Report

802.11n(HT20)

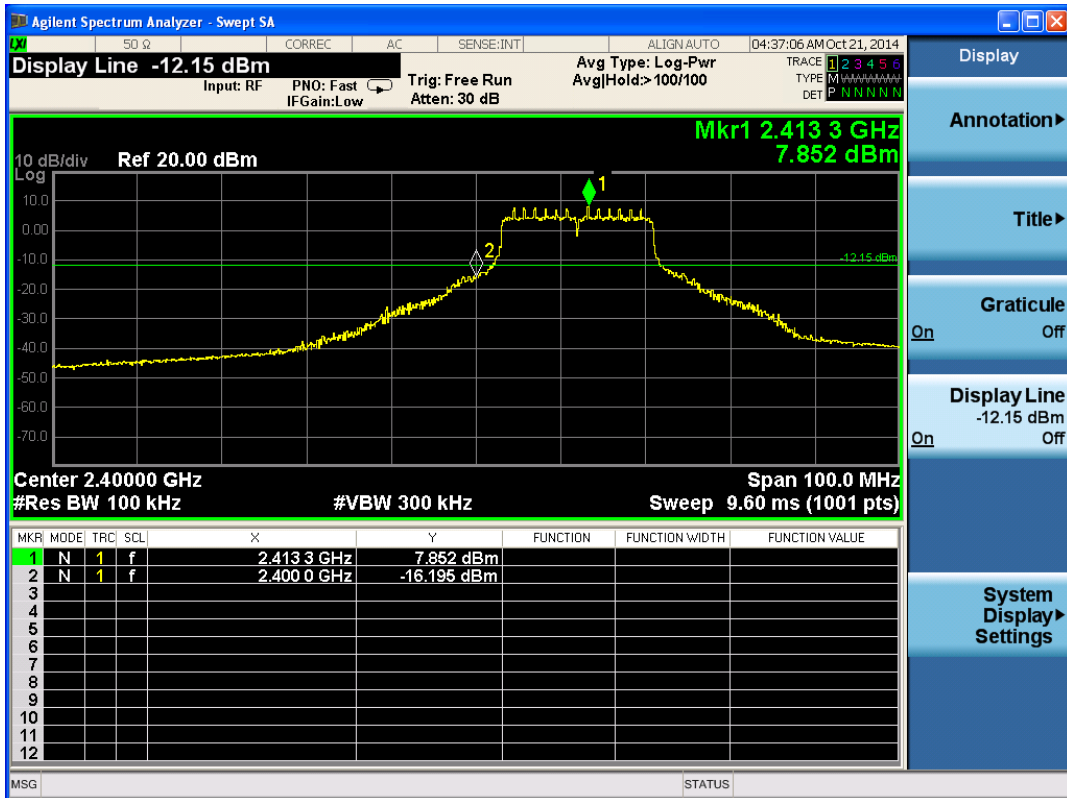

802.11n, Channel No.: 1

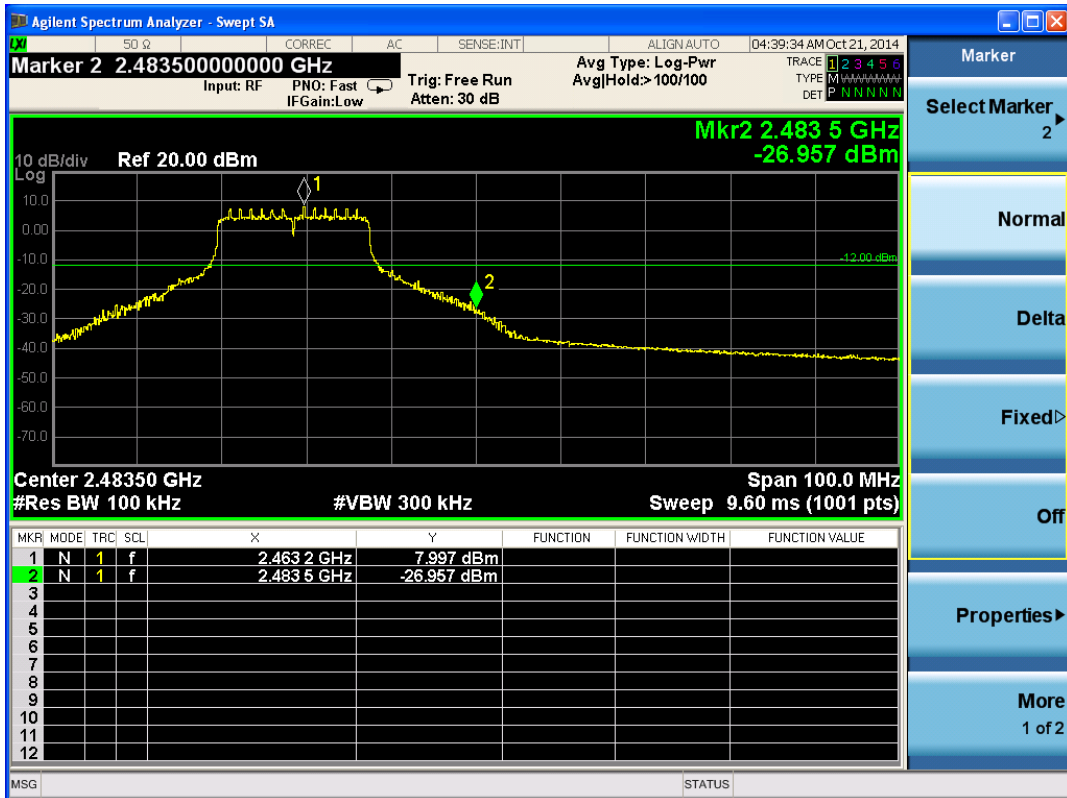

802.11n, Channel No.: 11

## 2.6. Spurious Radiated Emissions in the restricted band

### Ambient condition

Temperature	Relative humidity	Pressure
23°C ~25°C	45%~50%	101.5kPa

The Equipment Under Test (EUT) was set up on a non-conductive table in the semi-anechoic chamber. The test was performed at the distance of 3 m between the EUT and the receiving antenna. The turntable shall be rotated from 0 to 360 degrees for detecting the maximum of radiated spurious signal level. The measurements shall be repeated with orthogonal polarization of the test antenna. RBW is set to 100kHz. The data of cable loss and antenna factor has been calibrated in full testing frequency range before the testing. Sweep the whole frequency band through the range from 9kHz to the 10th harmonic of the carrier, and the emissions less than 20 dB below the permissible value are reported.

Set the spectrum analyzer in the following:

- (a) PEAK: RBW=VBW=1MHz / Sweep=AUTO
- (b) AVERAGE: RBW=1MHz / VBW=10Hz / Sweep=AUTO

This setting method can refer to **KDB 558074**.

The field strength of spurious emission was measured in the following position: EUT stand-up position (Z axis), lie-down position (X, Y axis). The worst emission was found in lie-down position (X axis) and the antenna is vertical.

The test is in transmitting mode.

# TA Technology (Shanghai) Co., Ltd. Test Report

## Test setup

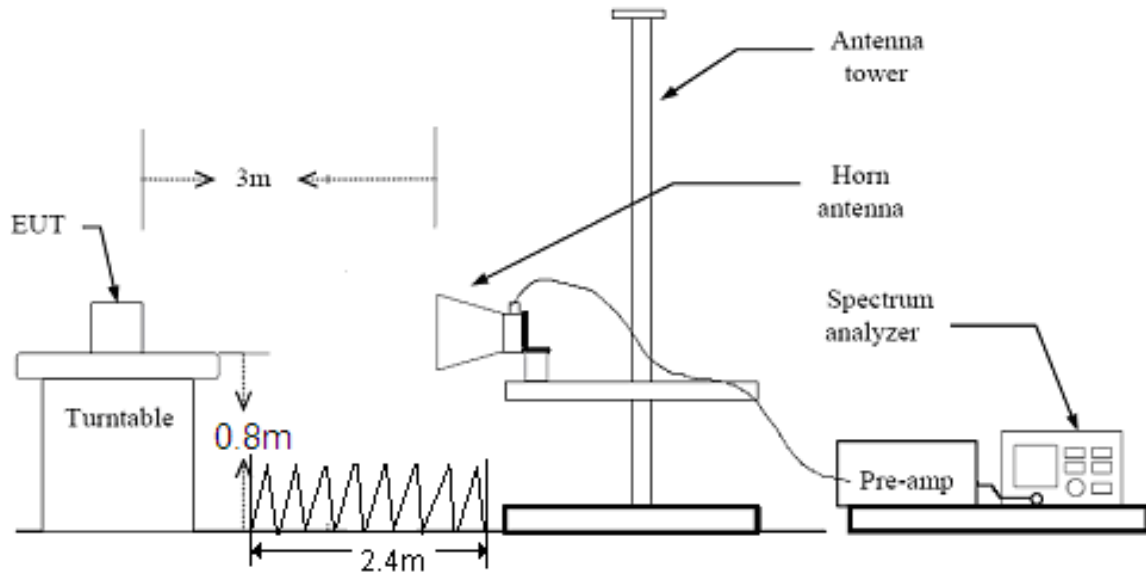

Note: Area side:2.4mX3.6m

## Limits

Spurious Radiated Emissions are permitted in any of the frequency bands listed below:

MHz	MHz	MHz	GHz
0.090 - 0.110	16.42 - 16.423	399.9 - 410	4.5 - 5.15
<sup>1</sup> 0.495 - 0.505	16.69475 - 16.69525	608 - 614	5.35 - 5.46
2.1735 - 2.1905	16.80425 - 16.80475	960 - 1240	7.25 - 7.75
4.125 - 4.128	25.5 - 25.67	1300 - 1427	8.025 - 8.5
4.17725 - 4.17775	37.5 - 38.25	1435 - 1626.5	9.0 - 9.2
4.20725 - 4.20775	73 - 74.6	1645.5 - 1646.5	9.3 - 9.5
6.215 - 6.218	74.8 - 75.2	1660 - 1710	10.6 - 12.7
6.26775 - 6.26825	108 - 121.94	1718.8 - 1722.2	13.25 - 13.4
6.31175 - 6.31225	123 - 138	2200 - 2300	14.47 - 14.5
8.291 - 8.294	149.9 - 150.05	2310 - 2390	15.35 - 16.2
8.362 - 8.366	156.52475 - 156.52525	2483.5 - 2500	17.7 - 21.4
8.37625 - 8.38675	156.7 - 156.9	2690 - 2900	22.01 - 23.12
8.41425 - 8.41475	162.0125 - 167.17	3260 - 3267	23.6 - 24.0
12.29 - 12.293	167.72 - 173.2	3332 - 3339	31.2 - 31.8
12.51975 - 12.52025	240 - 285	3345.8 - 3358	36.43 - 36.5
12.57675 - 12.57725	322 - 335.4	3600 - 4400	( <sup>2</sup> )
13.36 - 13.41			

Limit in restricted band

Frequency of emission (MHz)	Field strength(uV/m)	Field strength(dBuV/m)
0.009-0.490	2400/F(kHz)	/
0.490-1.705	24000/F(kHz)	/

**TA Technology (Shanghai) Co., Ltd.**  
**Test Report**

Report No.: RXA1409-0216RF01R1

Page 23 of 96

1.705–30.0	30	/
30-88	100	40
88-216	150	43.5
216-960	200	46
Above960	500	54

§15.35(b)

There is also a limit on the radio frequency emissions, as measured using instrumentation with a peak detector function, corresponding to 20 dB above the maximum permitted average limit.

Peak Limit=74 dBuV/m

Average Limit=54 dBuV/m

**Measurement Uncertainty**

The assessed measurement uncertainty to ensure 95% confidence level for the normal distribution is with the coverage factor  $k = 1.96$ ,  $U = 3.55$  dB.

Test Results: PASS  
802.11b-Channel 1:

Peak

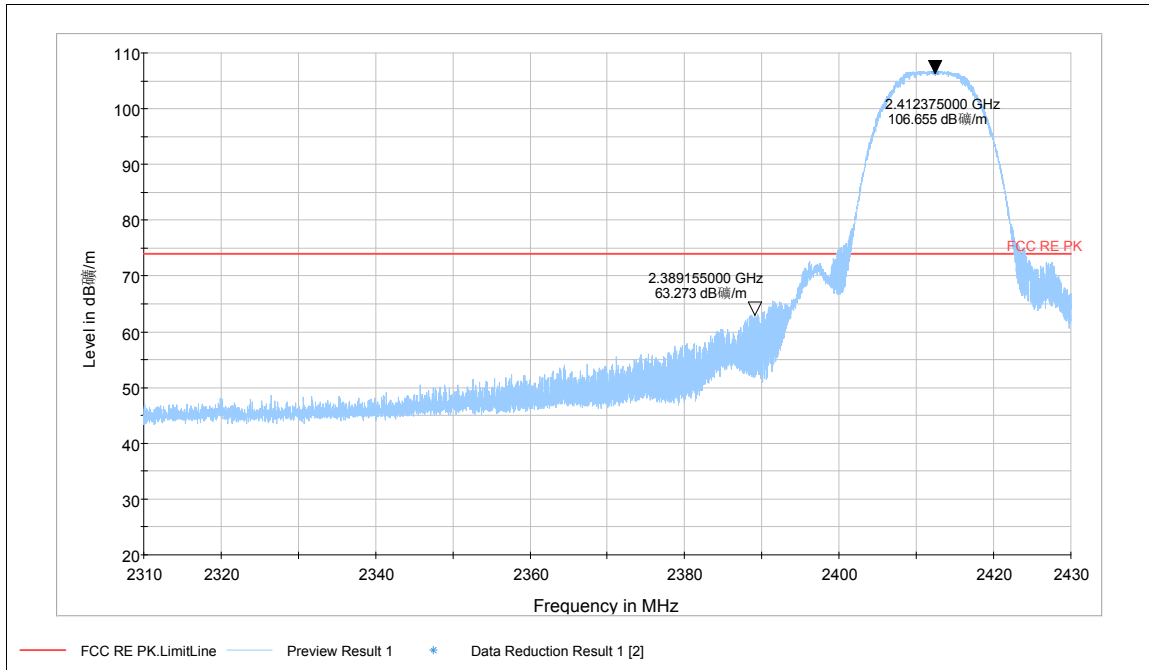

Note: The signal beyond the limit is carrier  
Channel 1

Average

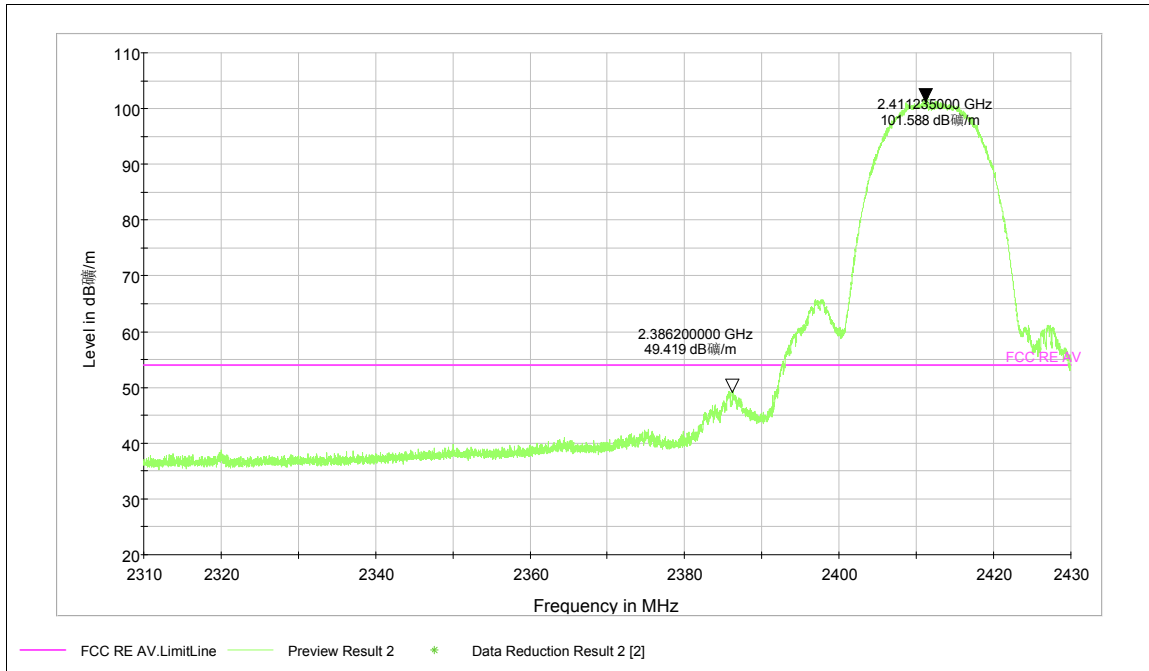

Note: The signal beyond the limit is carrier  
Channel 1



802.11b-Channel 11:

Peak

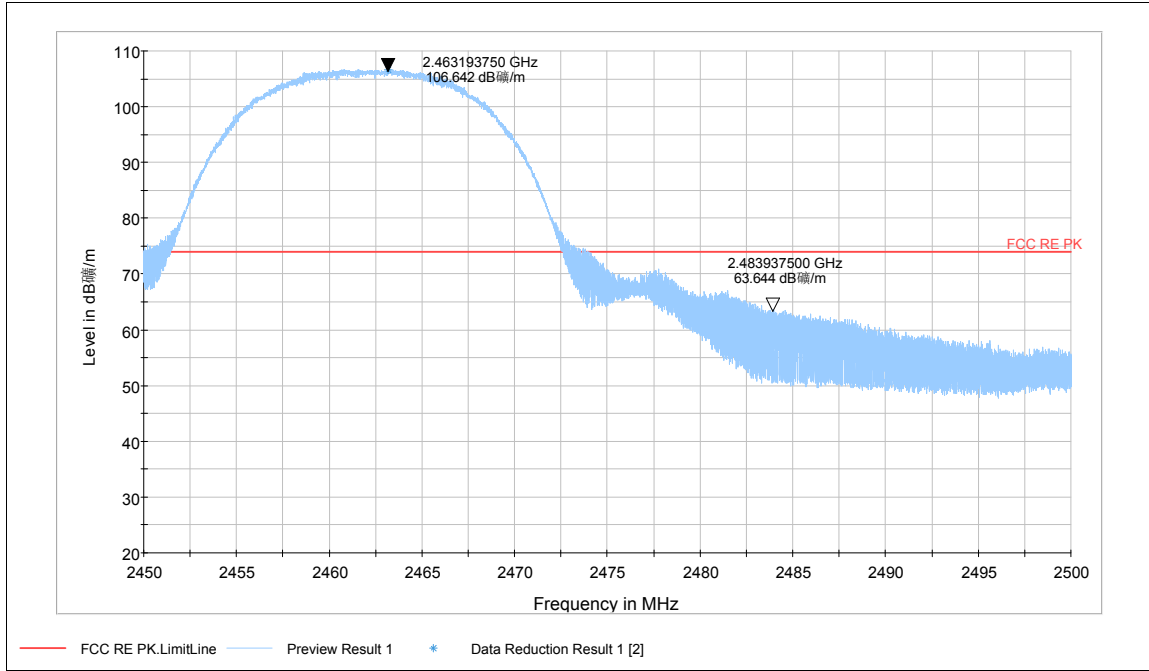

Note: The signal beyond the limit is carrier  
Channel 11

Average

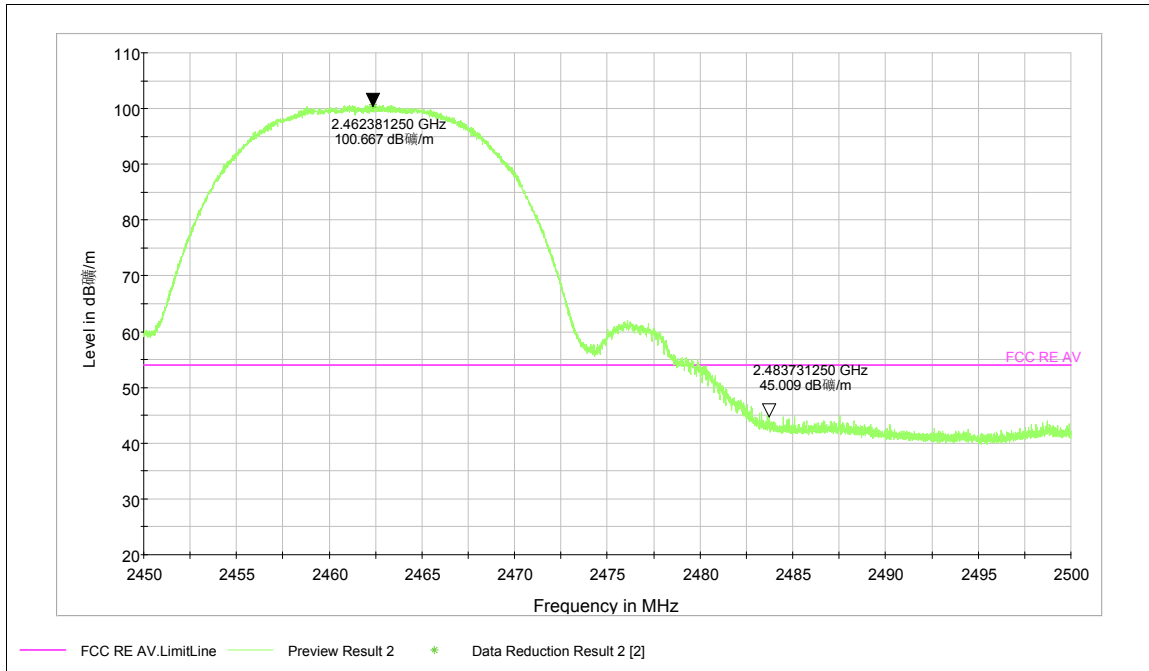

Note: The signal beyond the limit is carrier  
Channel 11

802.11g-Channel 1:

Peak

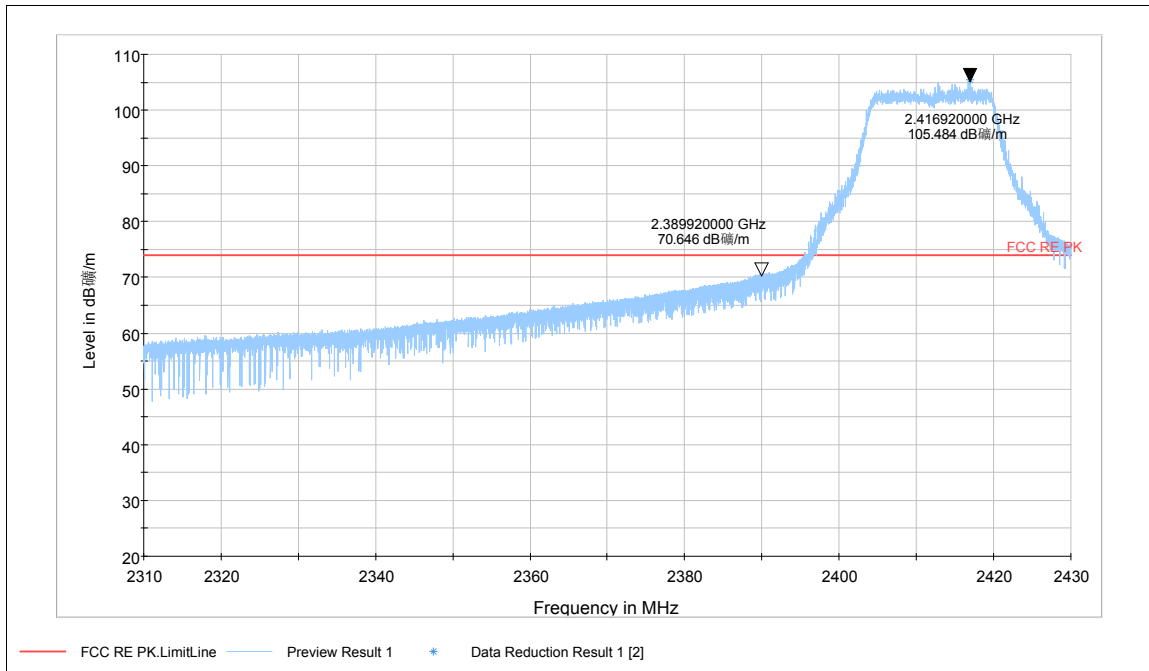

Note: The signal beyond the limit is carrier  
Channel 1

Average

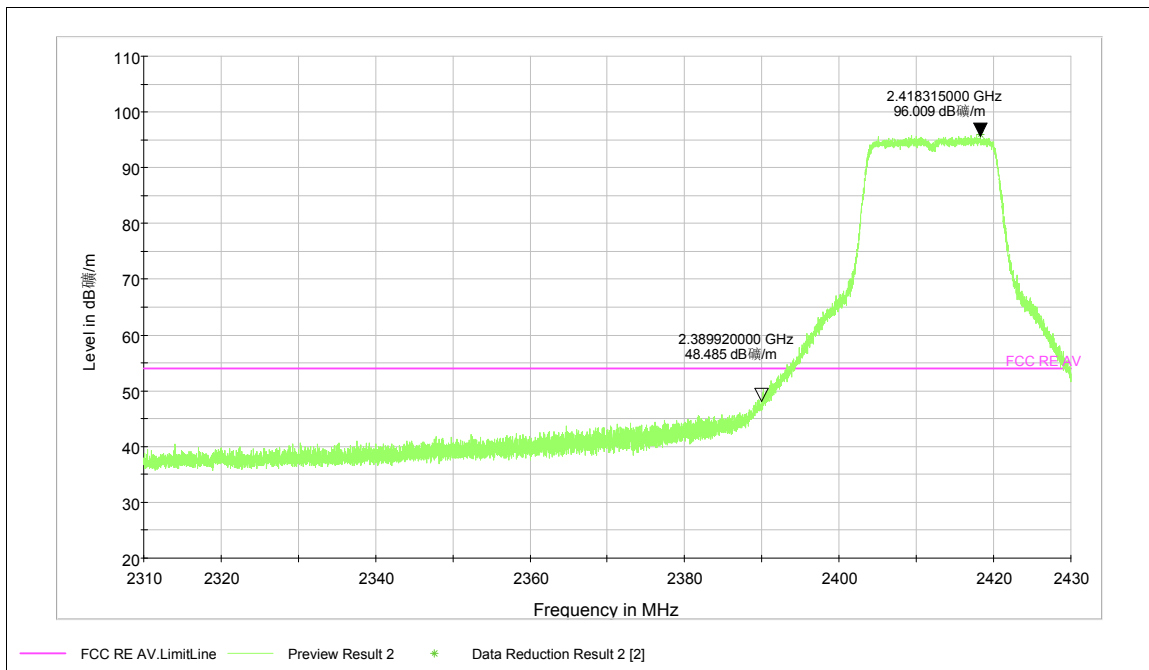

Note: The signal beyond the limit is carrier  
Channel 1

802.11g-Channel 11:

Peak

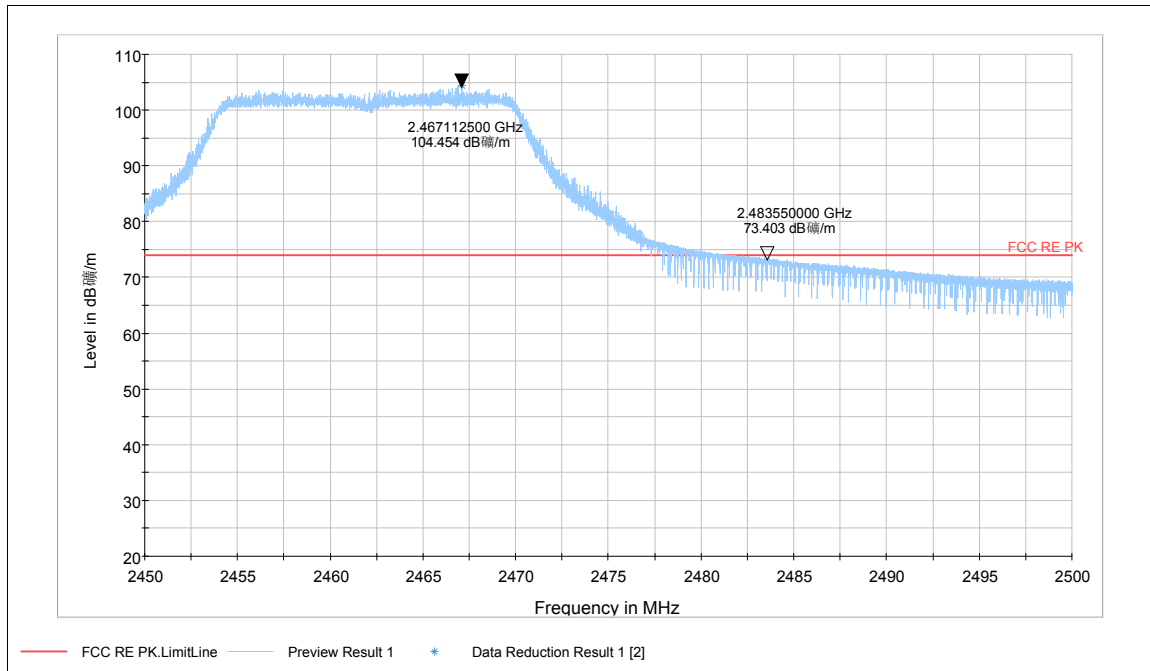

Note: The signal beyond the limit is carrier  
Channel 11

Average

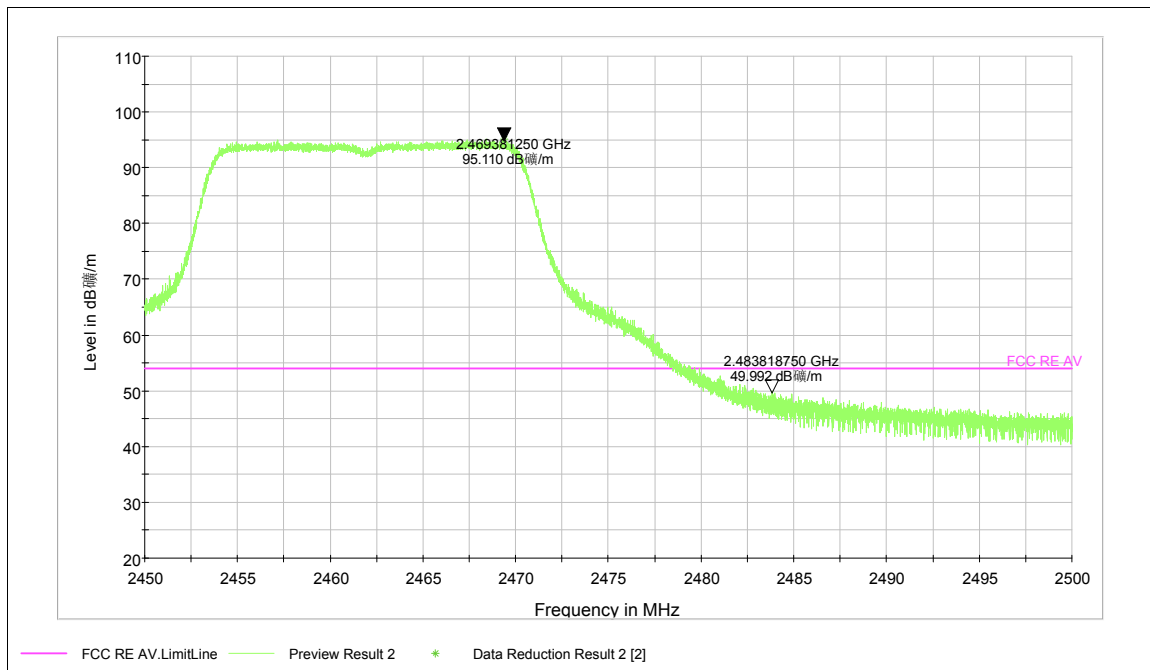

Note: The signal beyond the limit is carrier  
Channel 11

802.11n-Channel 1(HT20):

Peak

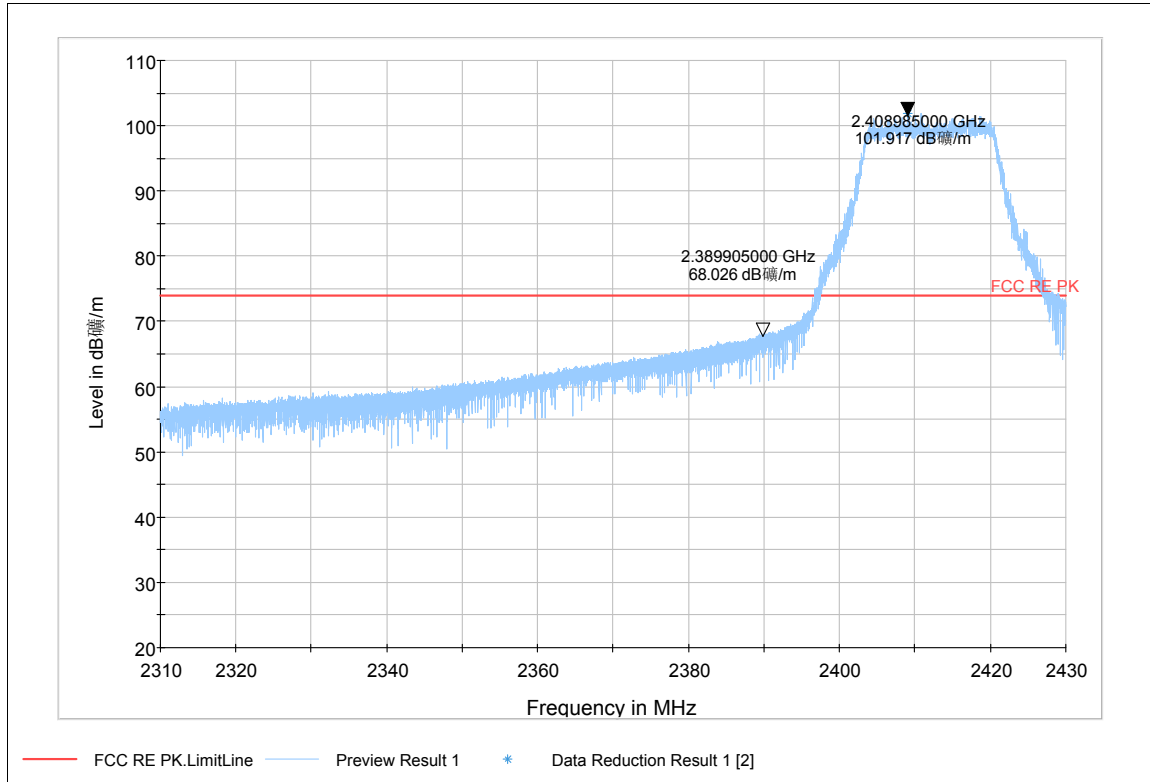

Note: The signal beyond the limit is carrier  
Channel 1

Average

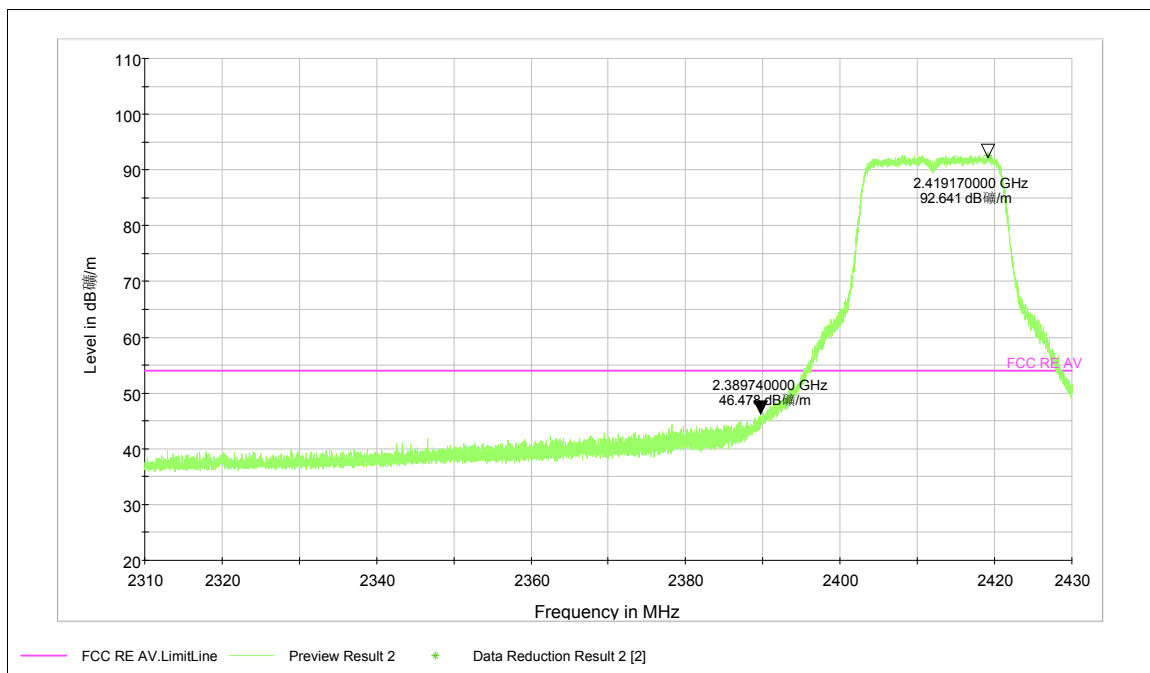

Note: The signal beyond the limit is carrier  
Channel 1

# TA Technology (Shanghai) Co., Ltd. Test Report

## 802.11n-Channel 11(HT20):

### Peak

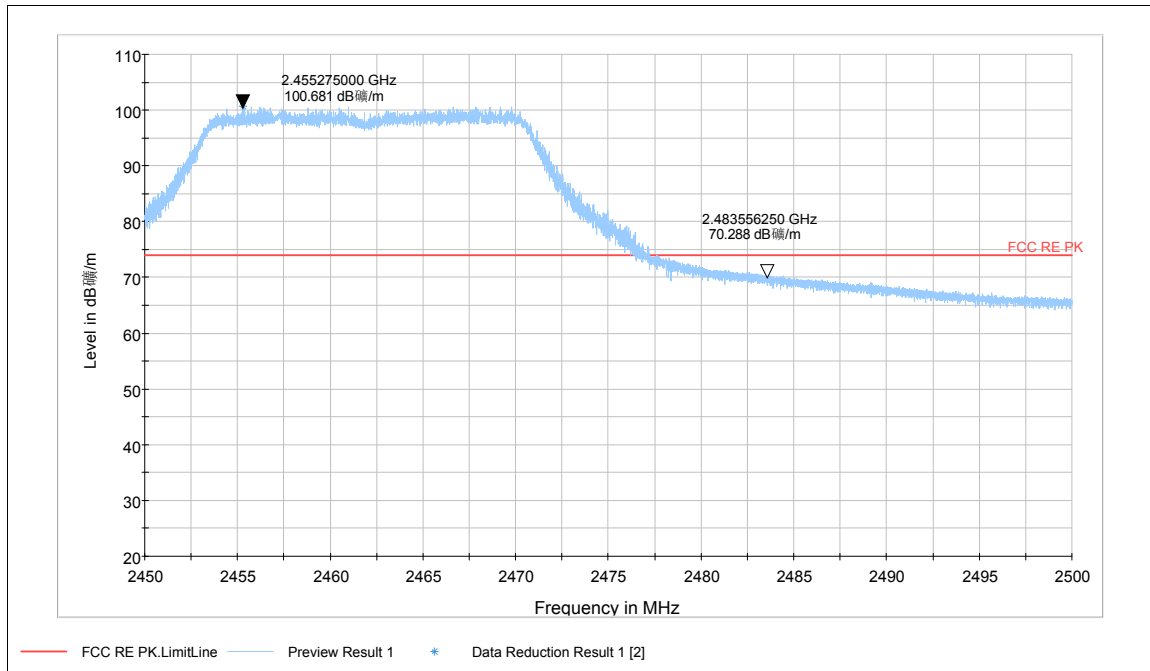

Note: The signal beyond the limit is carrier  
Channel 11

### Average

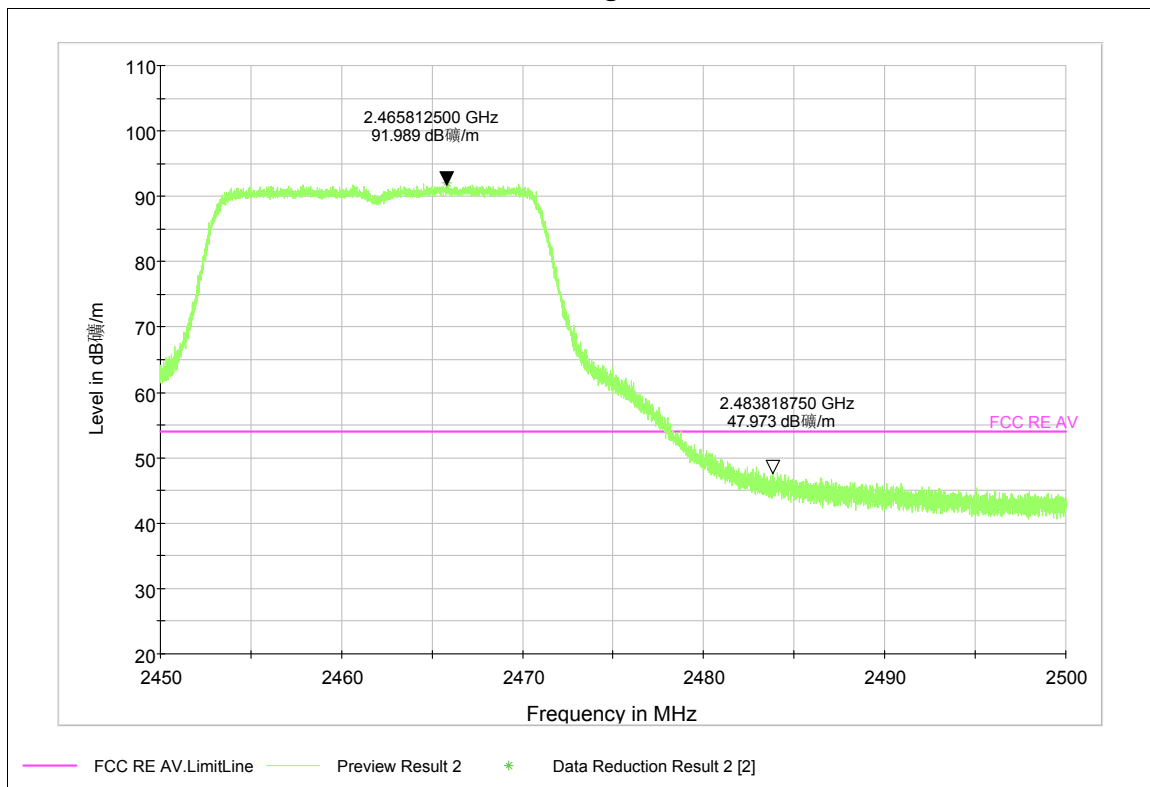

Note: The signal beyond the limit is carrier  
Channel 11

## 2.7. Power Spectral Density

### Ambient condition

Temperature	Relative humidity	Pressure
23°C ~25°C	45%~50%	101.5kPa

### Method of Measurement

The EUT was connected to the spectrum analyzer through an external attenuator (20dB) and a known loss cable. RBW is set to 3 kHz and VBW is set to 10 kHz on spectrum analyzer. Set the span to at least 1.5 times the DTS channel bandwidth. Sweep time = auto couple. Trace mode = max hold. The peak power spectral density is recorded.

### Test setup

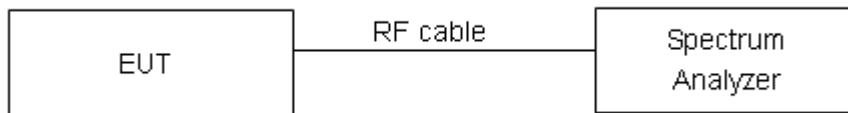

### Limits

Rule Part 15.247(e) specifies that " For digitally modulated systems, the power spectral density conducted from the intentional radiator to the antenna shall not be greater than 8 dBm in any 3 kHz band during any time interval of continuous transmission. "

Limits	$\leq 8 \text{ dBm} / 3\text{kHz}$
--------	------------------------------------

### Measurement Uncertainty

The assessed measurement uncertainty to ensure 95% confidence level for the normal distribution is with the coverage factor  $k = 2$ ,  $U = 0.75\text{dB}$ .

# TA Technology (Shanghai) Co., Ltd. Test Report

**Test Results:**

Network Standards	Channel Number	Power Spectral Density dBm / 3kHz	Conclusion
802.11b	1	-6.32	PASS
	6	-6.55	PASS
	11	-6.94	PASS
802.11g	1	-6.11	PASS
	6	-7.11	PASS
	11	-7.71	PASS
802.11n HT20	1	-7.66	PASS
	6	-7.00	PASS
	11	-7.79	PASS

802.11b

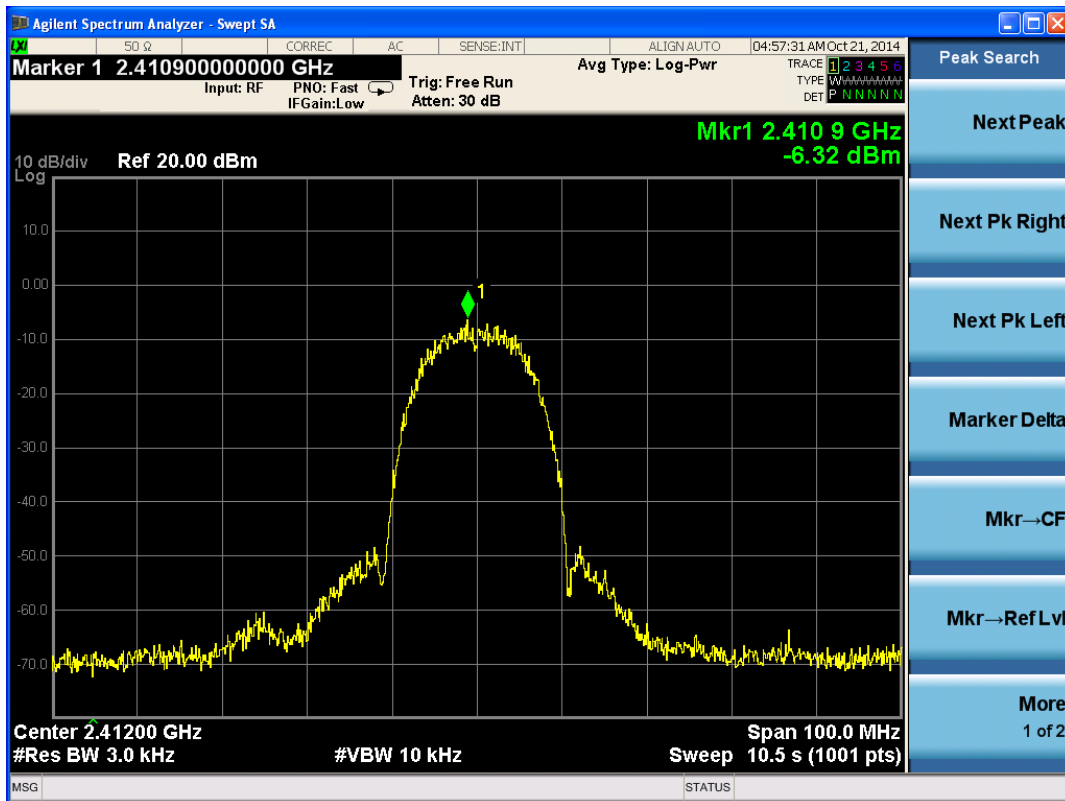

802.11b, Channel No.: 1

# TA Technology (Shanghai) Co., Ltd. Test Report

Report No.: RXA1409-0216RF01R1

Page 32of 96

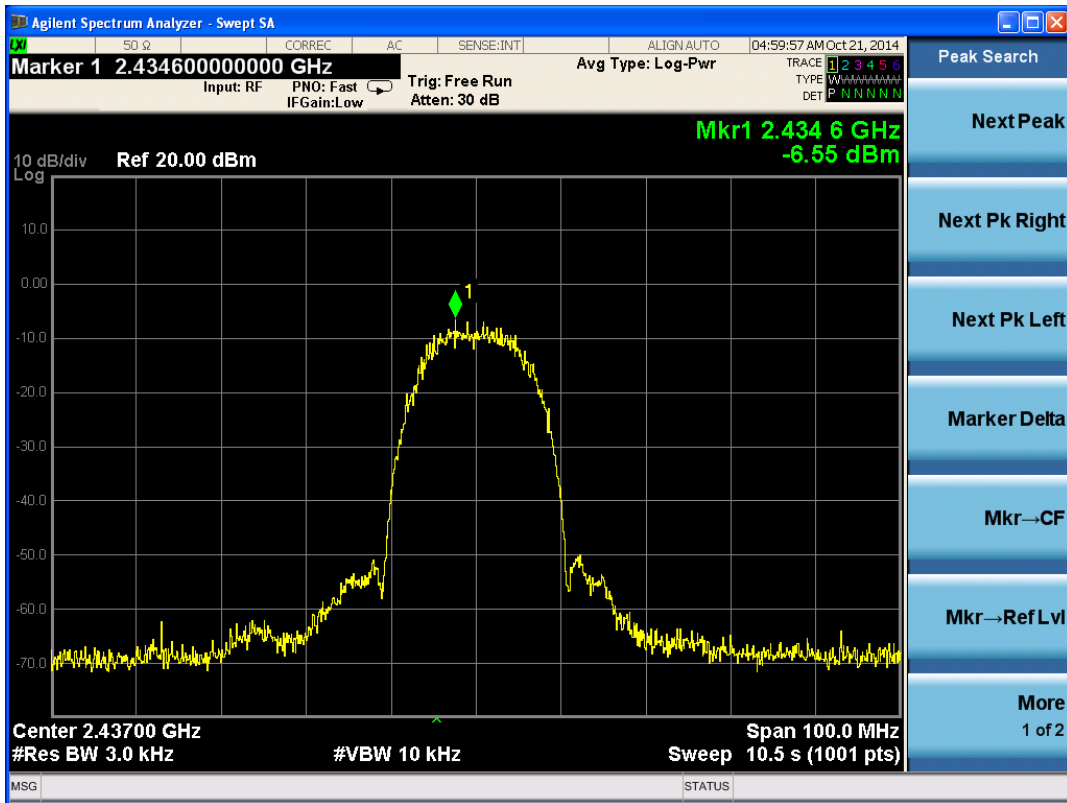

802.11b, Channel No.: 6

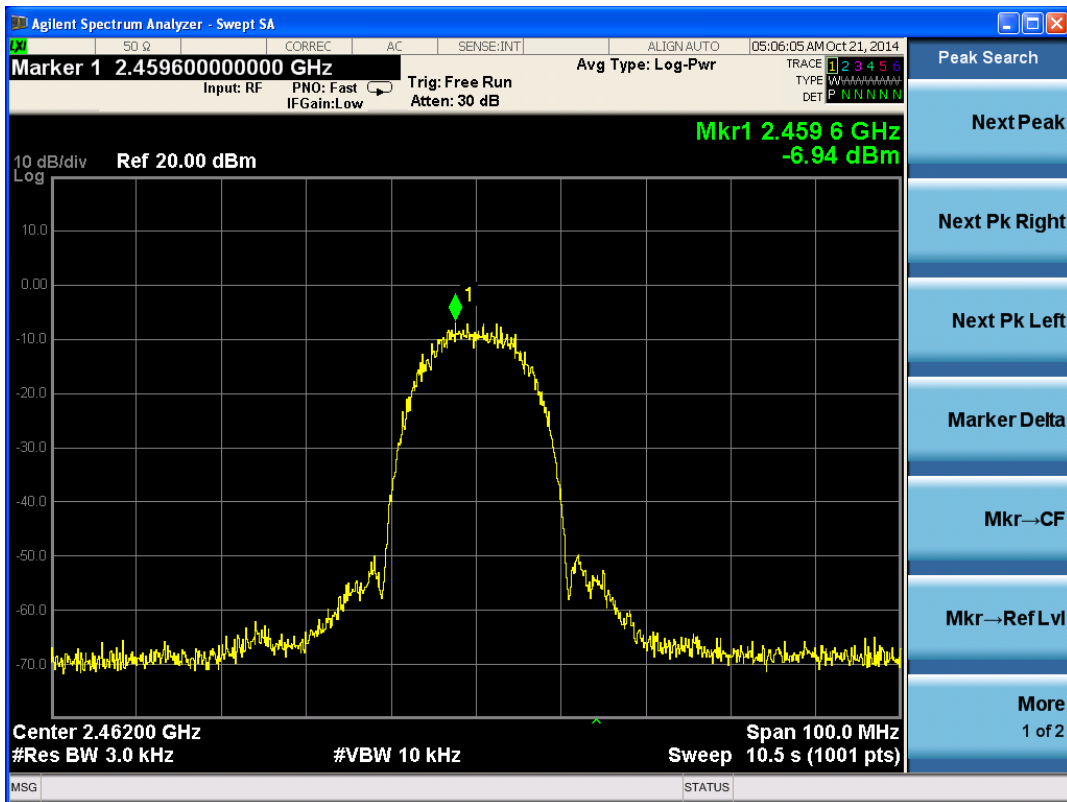

802.11b, Channel No.: 11



# TA Technology (Shanghai) Co., Ltd. Test Report

Report No.: RXA1409-0216RF01R1

Page 33of 96

802.11g

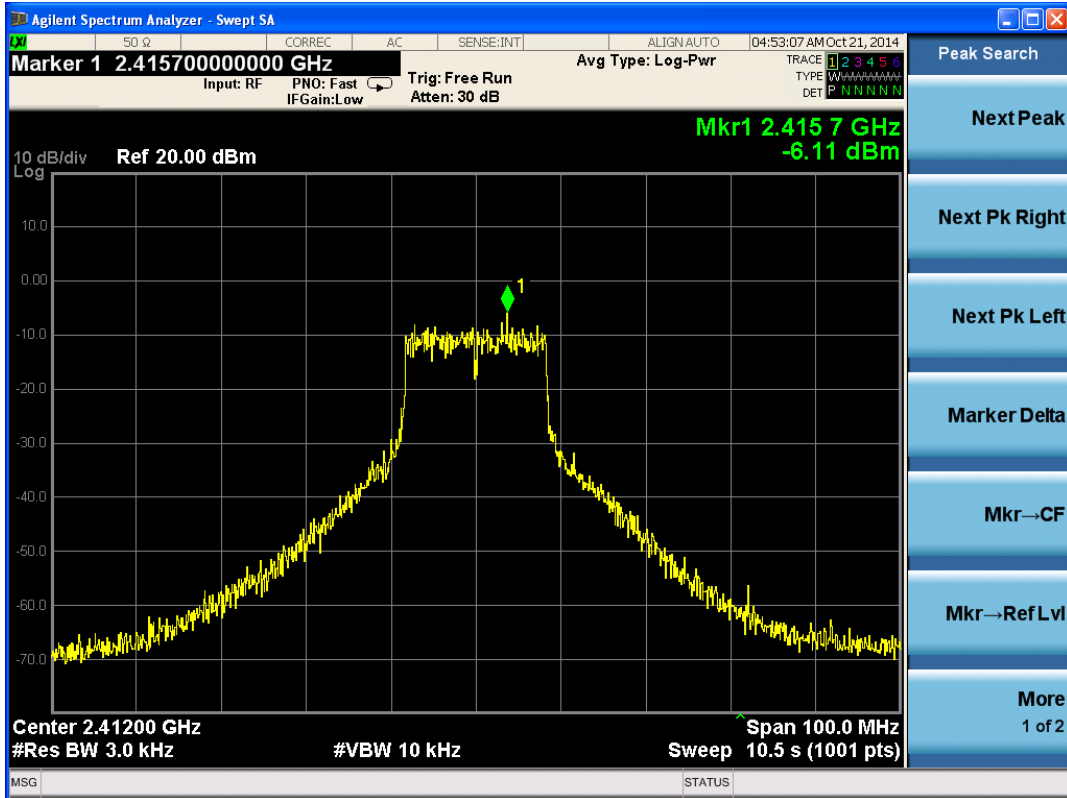

802.11g, Channel No.: 1

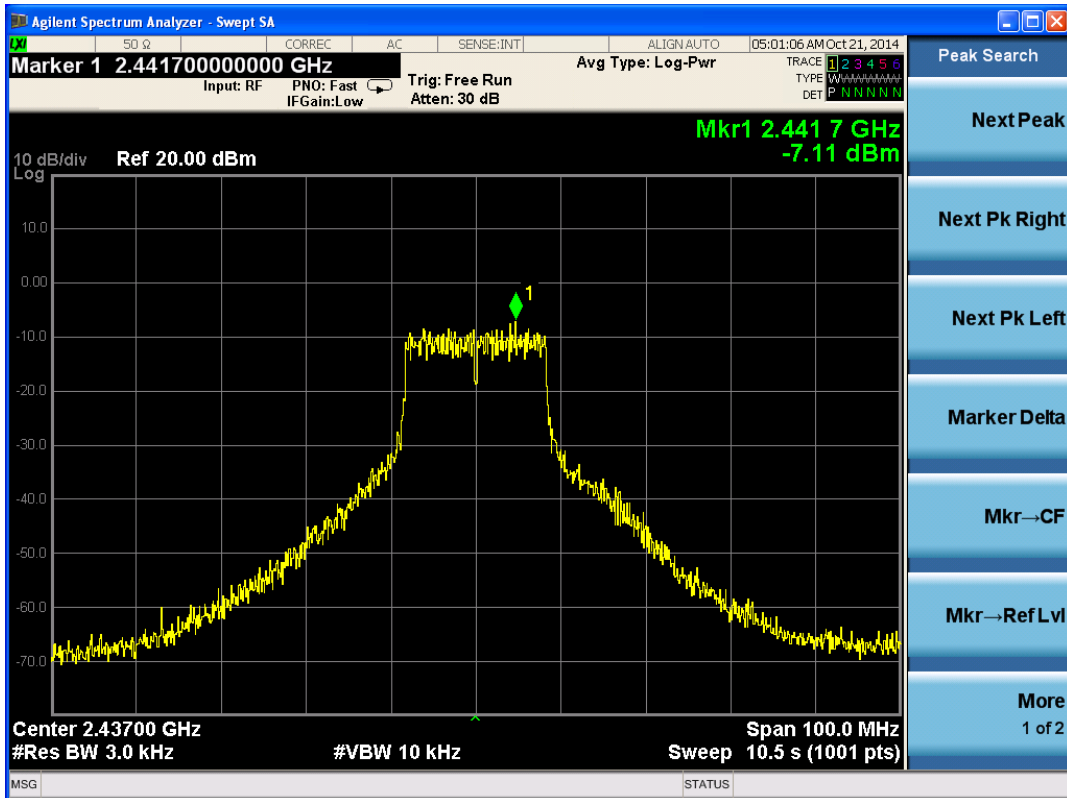

802.11g, Channel No.: 6

# TA Technology (Shanghai) Co., Ltd. Test Report

Report No.: RXA1409-0216RF01R1

Page 34 of 96

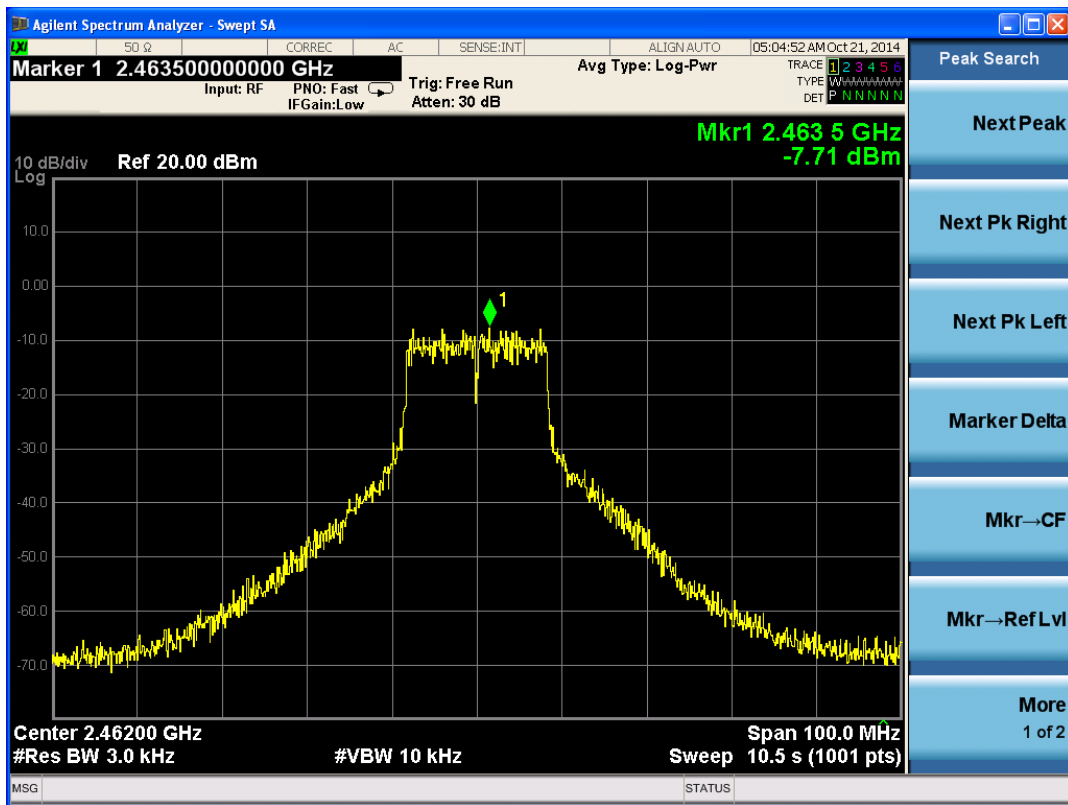

802.11g, Channel No.: 11

802.11n(HT20)

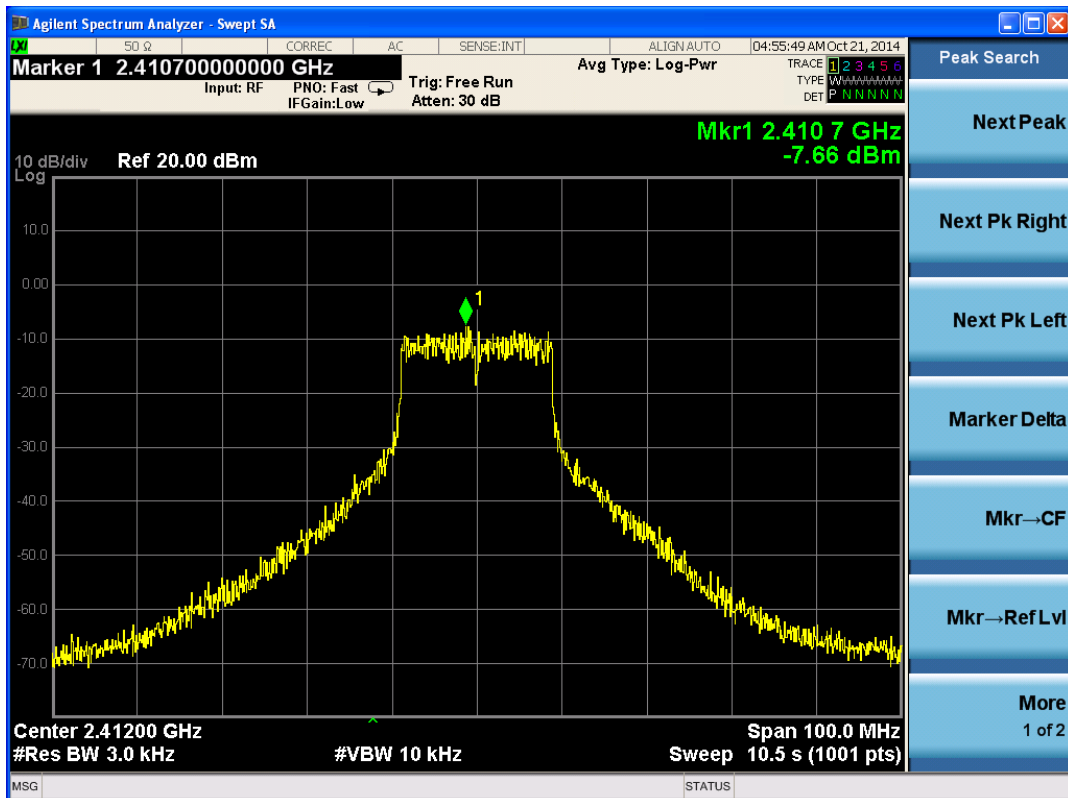

802.11n, Channel No.: 1

# TA Technology (Shanghai) Co., Ltd. Test Report

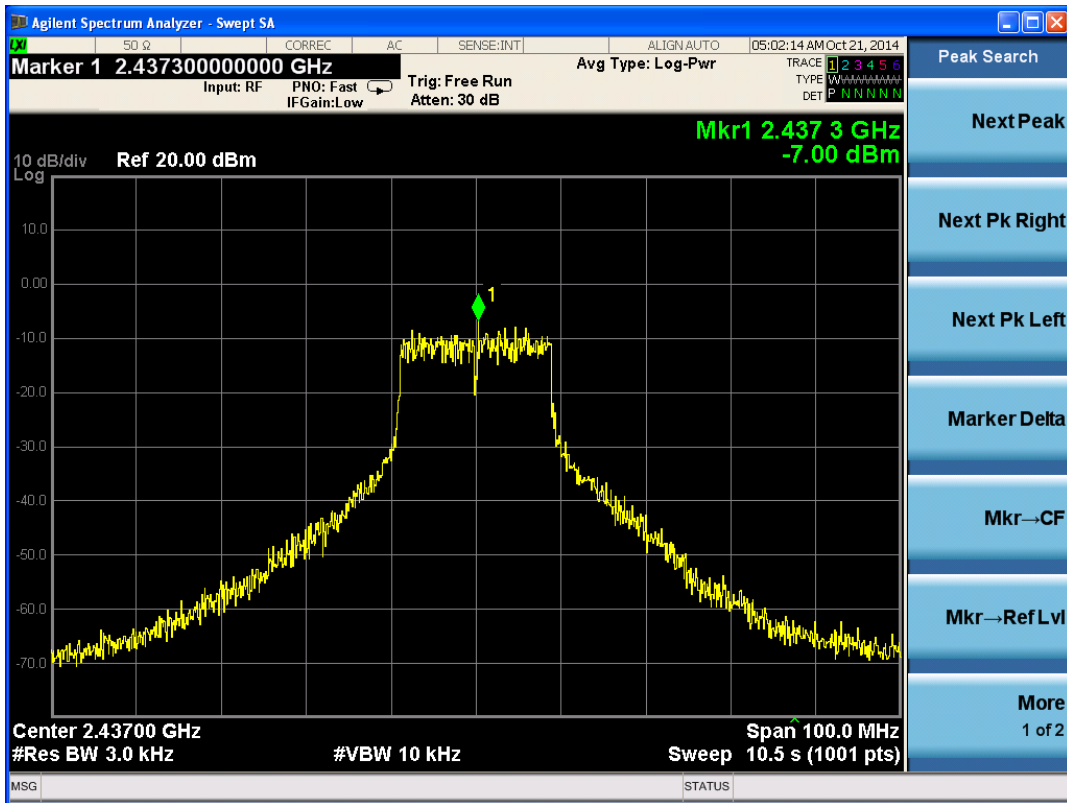

802.11n, Channel No.: 6

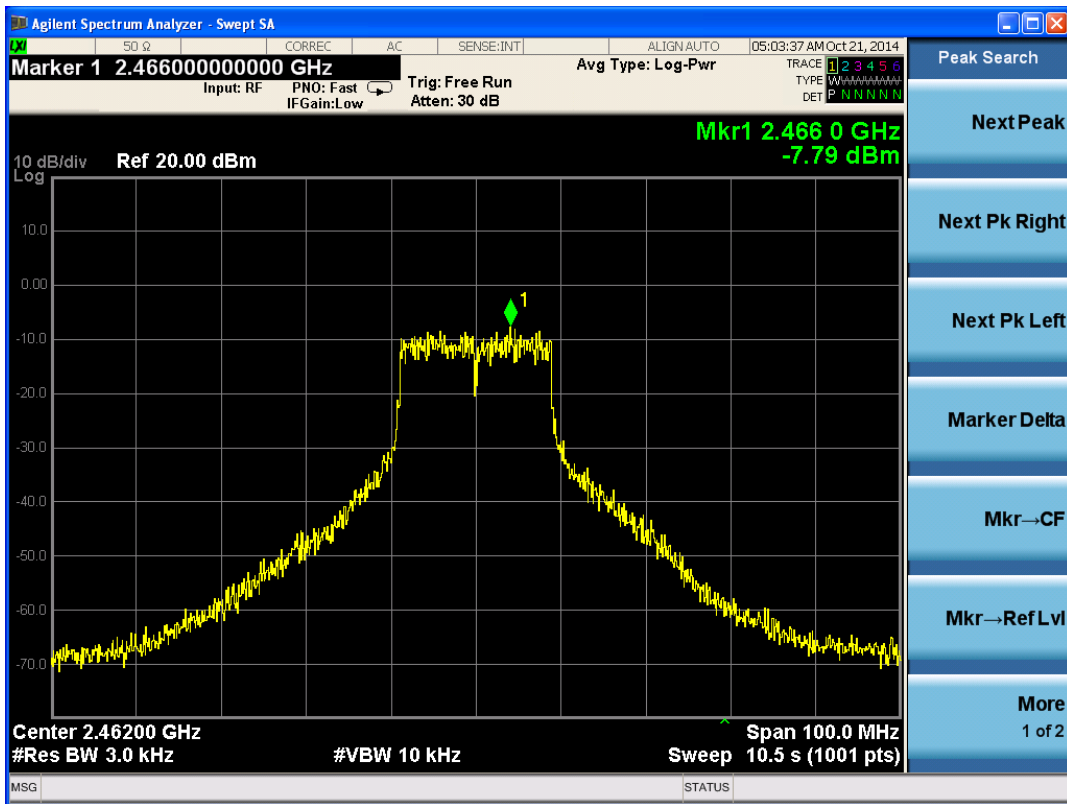

802.11n, Channel No.: 11

# TA Technology (Shanghai) Co., Ltd.

## Test Report

### 2.8. Spurious RF Conducted Emissions

#### Ambient condition

Temperature	Relative humidity	Pressure
23°C ~25°C	45%~50%	101.5kPa

#### Method of Measurement

The EUT was connected to the spectrum analyzer and WIFI test set via a power splitter with a known loss. The spectrum analyzer scans from 30MHz to the 10th harmonic of the carrier. The peak detector is used. RBW and VBW are set to 100 kHz, Sweep is set to ATUO.

The test is in transmitting mode.

#### Test setup



#### Limits

Rule Part 15.247(d) pacifies that “In any 100 kHz bandwidth outside the frequency band in which the spread spectrum intentional radiator is operating, the radio frequency power that is produced by the intentional radiator shall be at least 20 dB below that in the 100 kHz bandwidth within the band that contains the highest level of the desired power.”

Network Standards	Carrier frequency (MHz)	Reference value (dBm)	Limit
802.11b	2412	11.426	-8.574
	2437	4.262	-15.74
	2462	9.259	-10.74
802.11g	2412	5.937	-14.06
	2437	-0.253	-20.25
	2462	4.382	-15.62
802.11n HT20	2412	2.217	-17.78
	2437	-3.140	-23.14
	2462	1.675	-18.33

**TA Technology (Shanghai) Co., Ltd.**  
**Test Report**

Report No.: RXA1409-0216RF01R1

Page 37 of 96

---

**Measurement Uncertainty**

The assessed measurement uncertainty to ensure 95% confidence level for the normal distribution is with the coverage factor  $k = 1.96$ .

Frequency	Uncertainty
100kHz-2GHz	0.684 dB
2GHz-26.5GHz	1.407 dB

# TA Technology (Shanghai) Co., Ltd. Test Report

Report No.: RXA1409-0216RF01R1

Page 38 of 96

## Test Results:

802.11b CH1

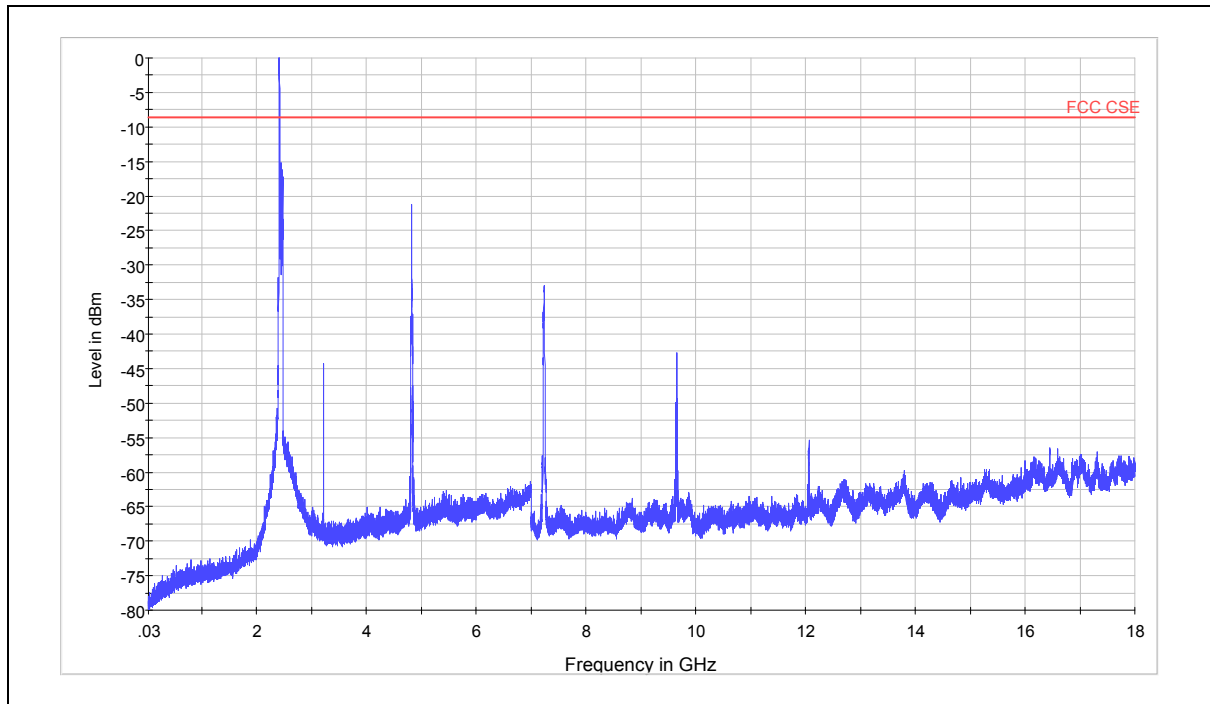

Note: The signal beyond the limit is carrier

Spurious RF conducted emissions from 30MHz to 18GHz

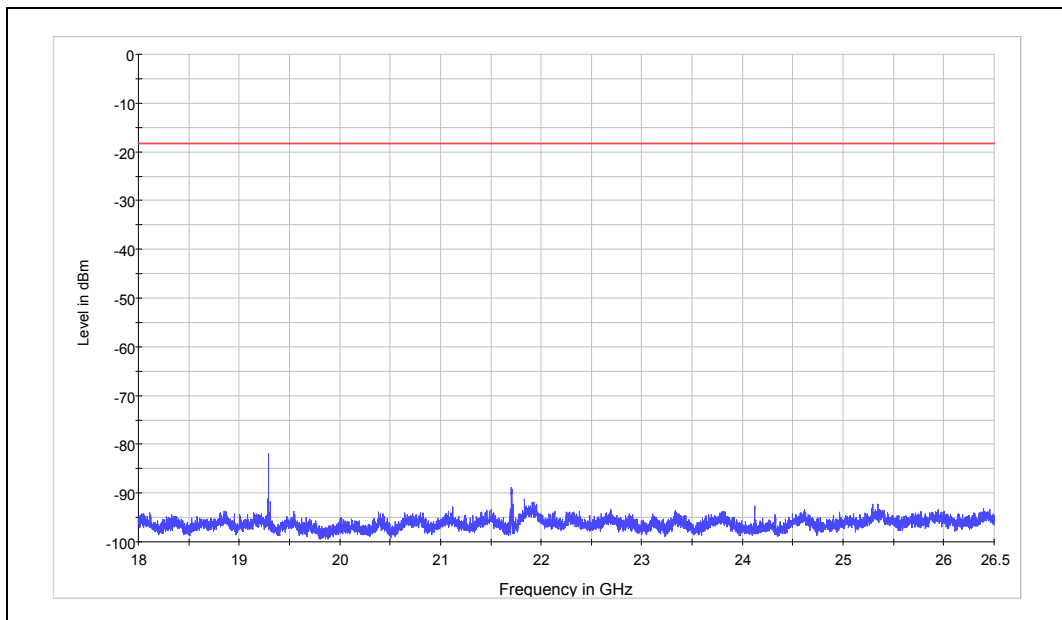

Spurious RF conducted emissions from 18GHz to 26.5GHz

# TA Technology (Shanghai) Co., Ltd. Test Report

Report No.: RXA1409-0216RF01R1

Page 39 of 96

802.11b CH6

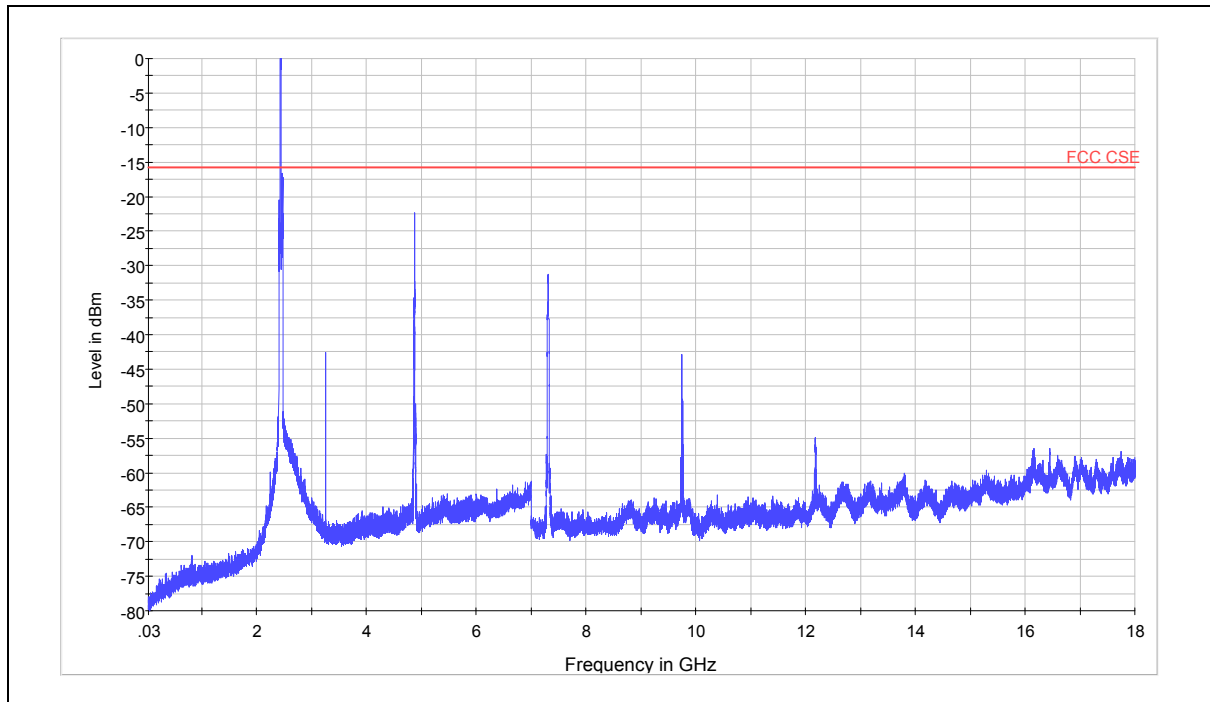

Note: The signal beyond the limit is carrier

Spurious RF conducted emissions from 30MHz to 18GHz

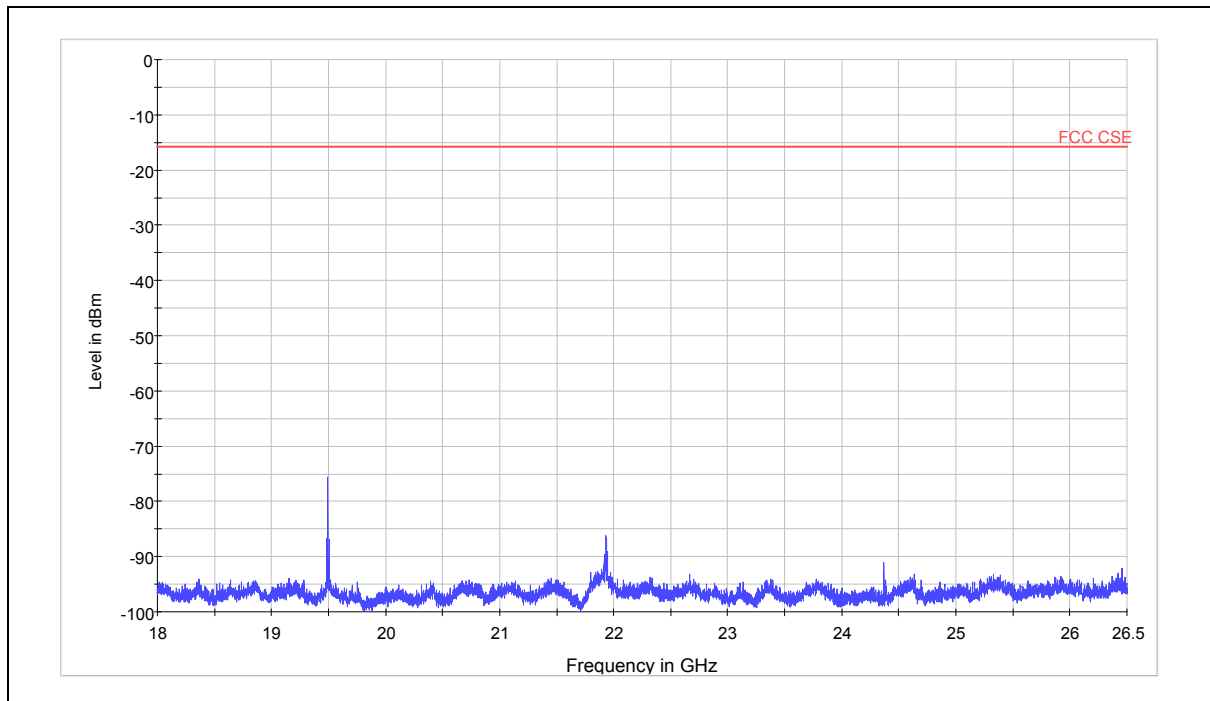

Spurious RF conducted emissions from 18GHz to 26.5GHz

Harmonic	TX ch.6 Frequency (MHz)	Level (dBm)	Margin (dB)	Limit (dBm)
2	4873.9	-22.37	6.63	-15.74

802.11b CH11

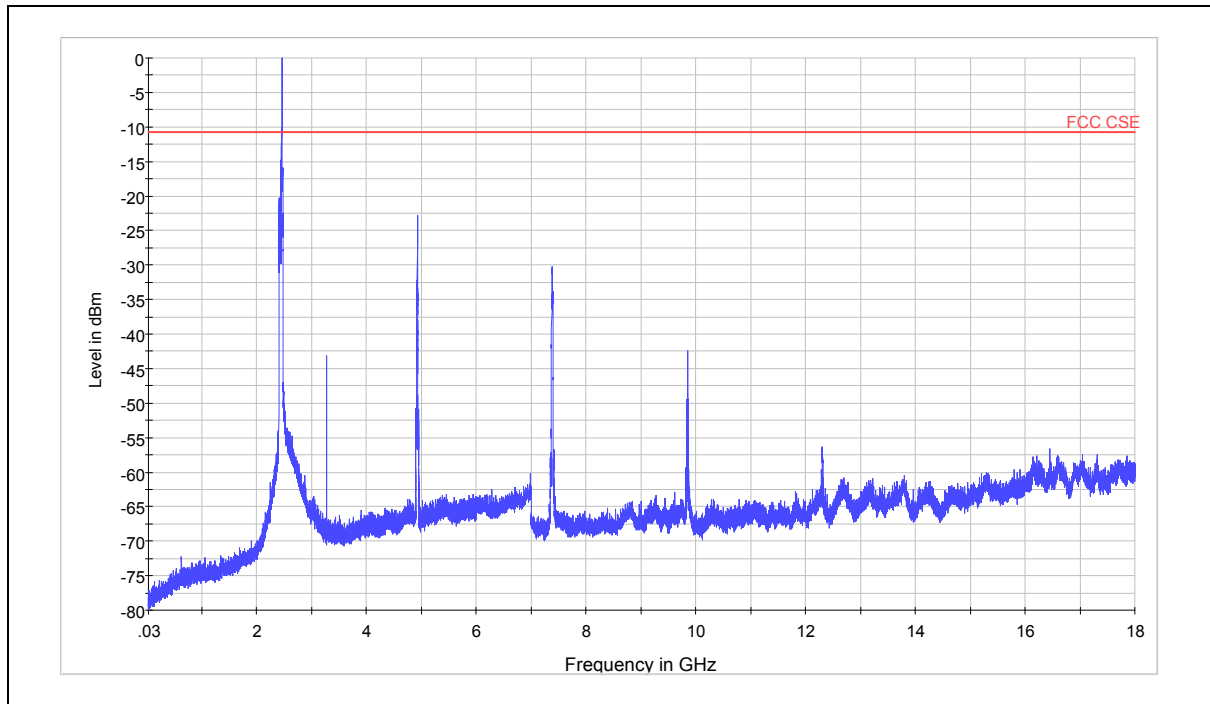

Note: The signal beyond the limit is carrier

Spurious RF conducted emissions from 30MHz to 18GHz

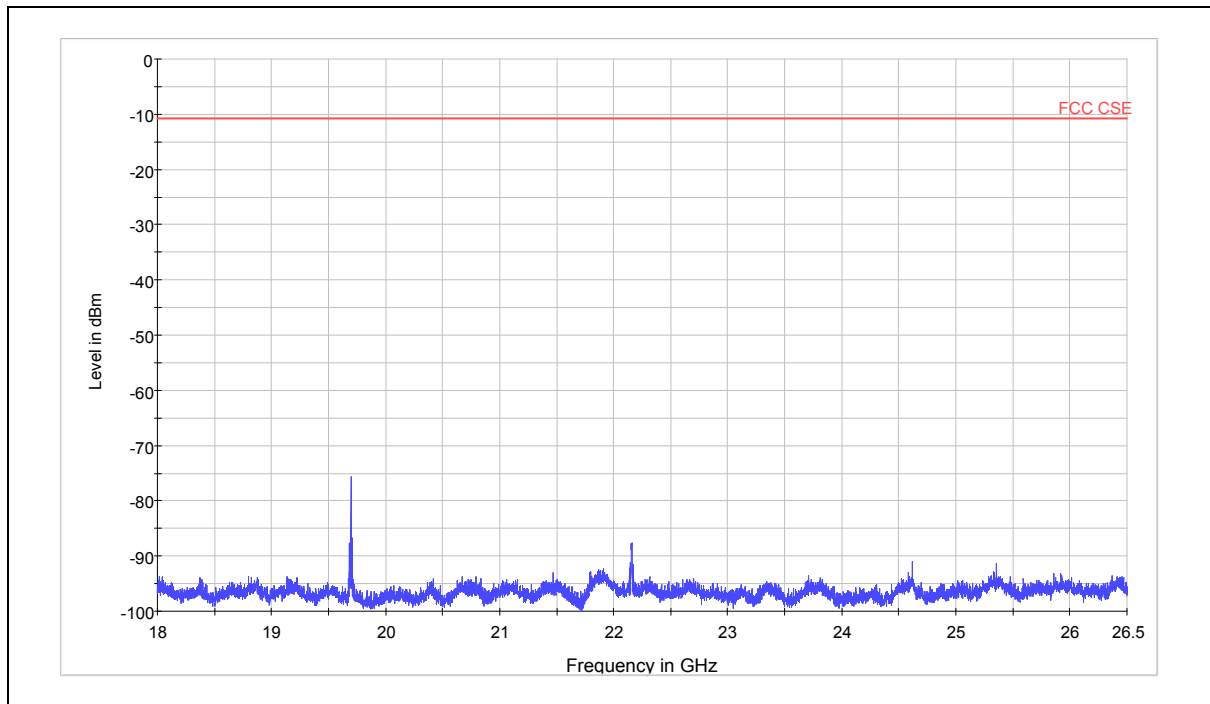

Spurious RF conducted emissions from 18GHz to 26.5GHz



802.11g CH1

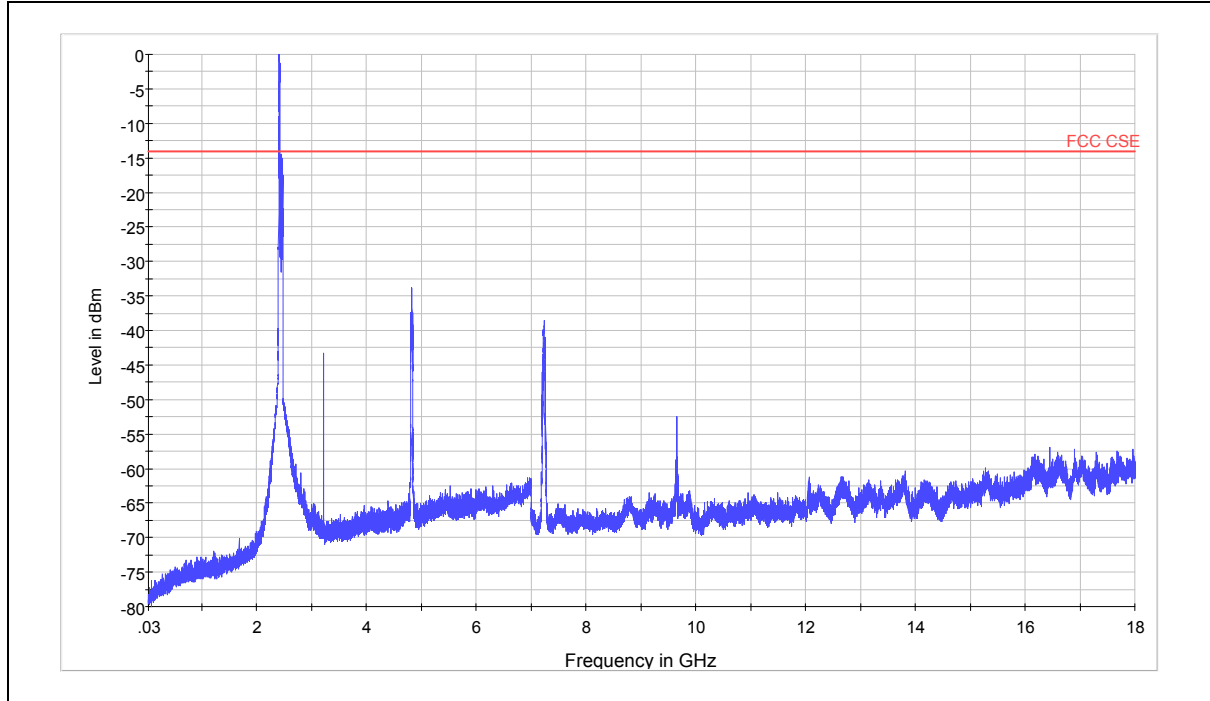

Note: The signal beyond the limit is carrier

Spurious RF conducted emissions from 30MHz to 18GHz

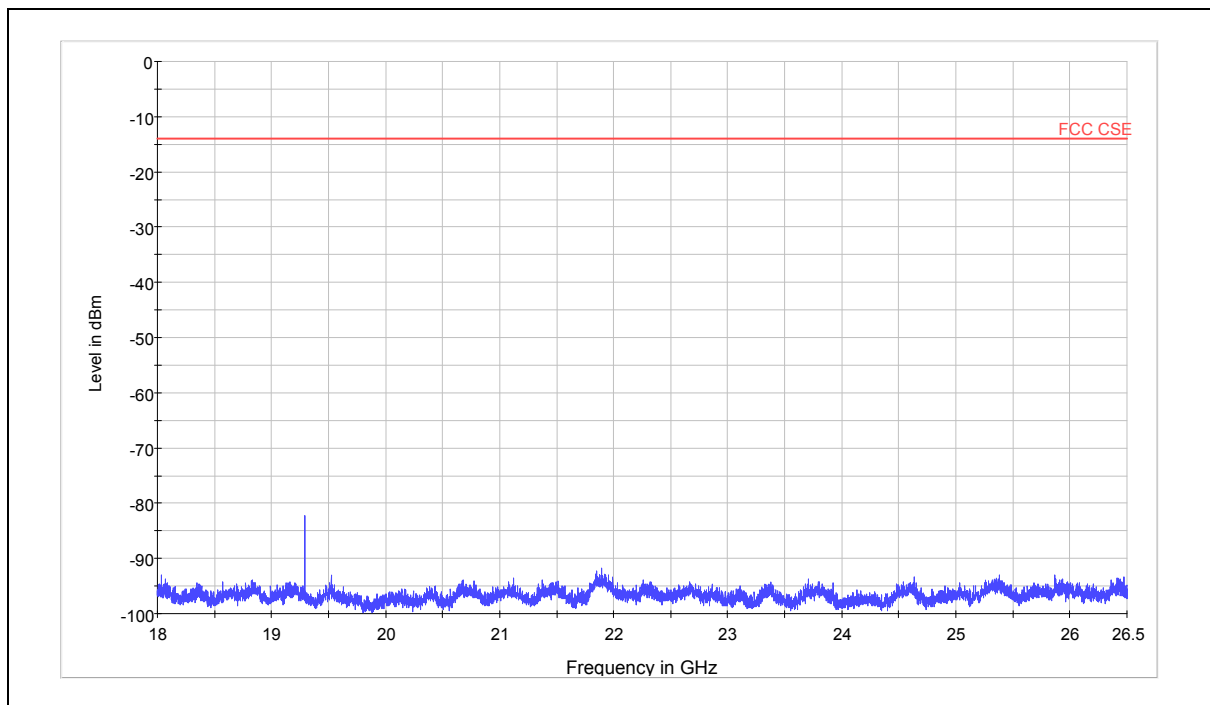

Spurious RF conducted emissions from 18GHz to 26.5GHz

# TA Technology (Shanghai) Co., Ltd. Test Report

Report No.: RXA1409-0216RF01R1

Page 42 of 96

802.11g CH6

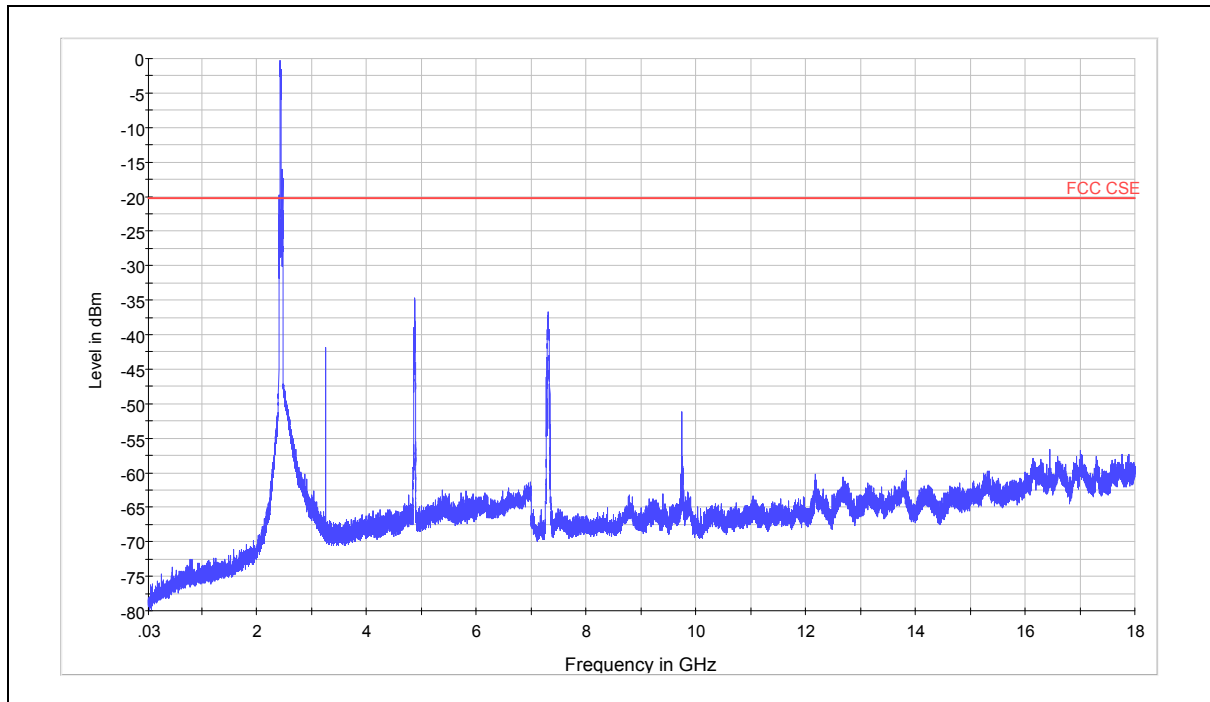

Note: The signal beyond the limit is carrier

Spurious RF conducted emissions from 30MHz to 18GHz

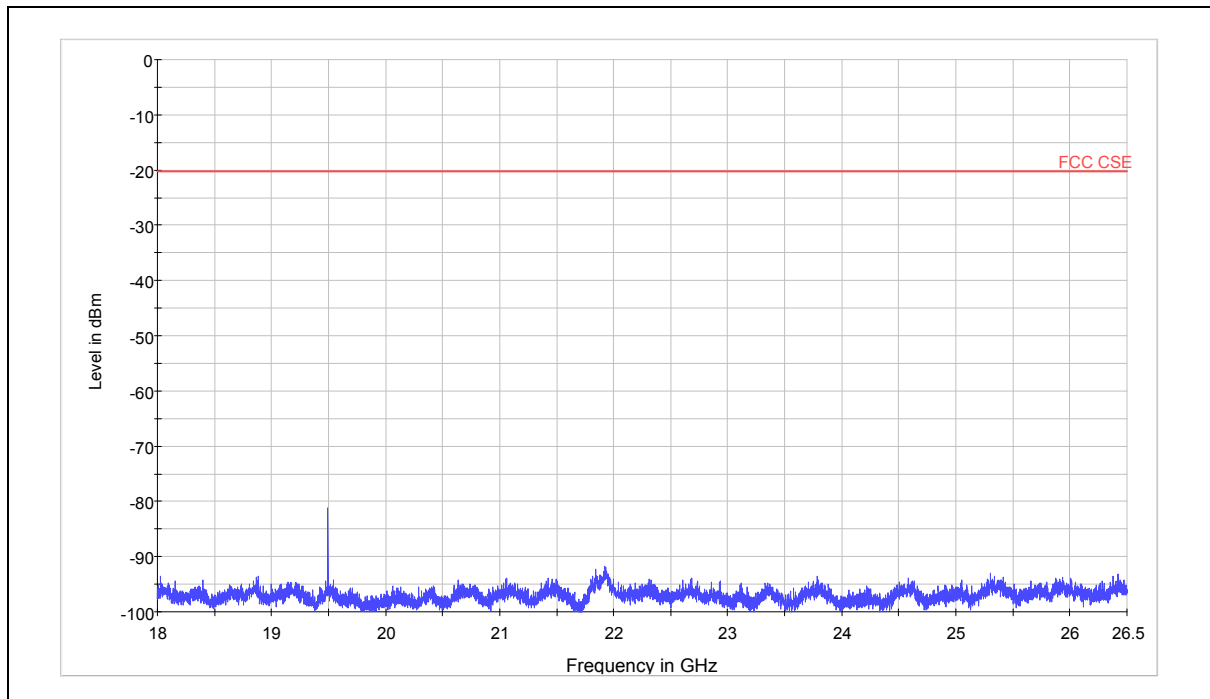

Spurious RF conducted emissions from 18GHz to 26.5GHz

# TA Technology (Shanghai) Co., Ltd. Test Report

Report No.: RXA1409-0216RF01R1

Page 43of 96

802.11g CH11

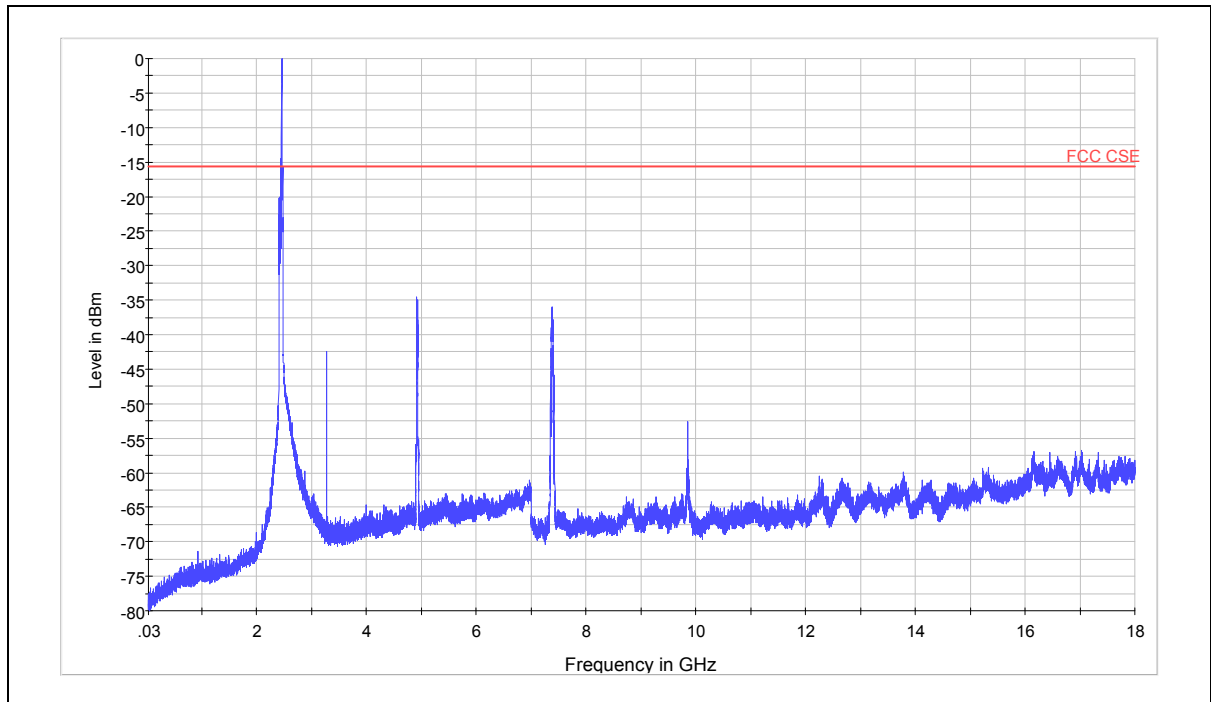

Note: The signal beyond the limit is carrier

Spurious RF conducted emissions from 30MHz to 18GHz

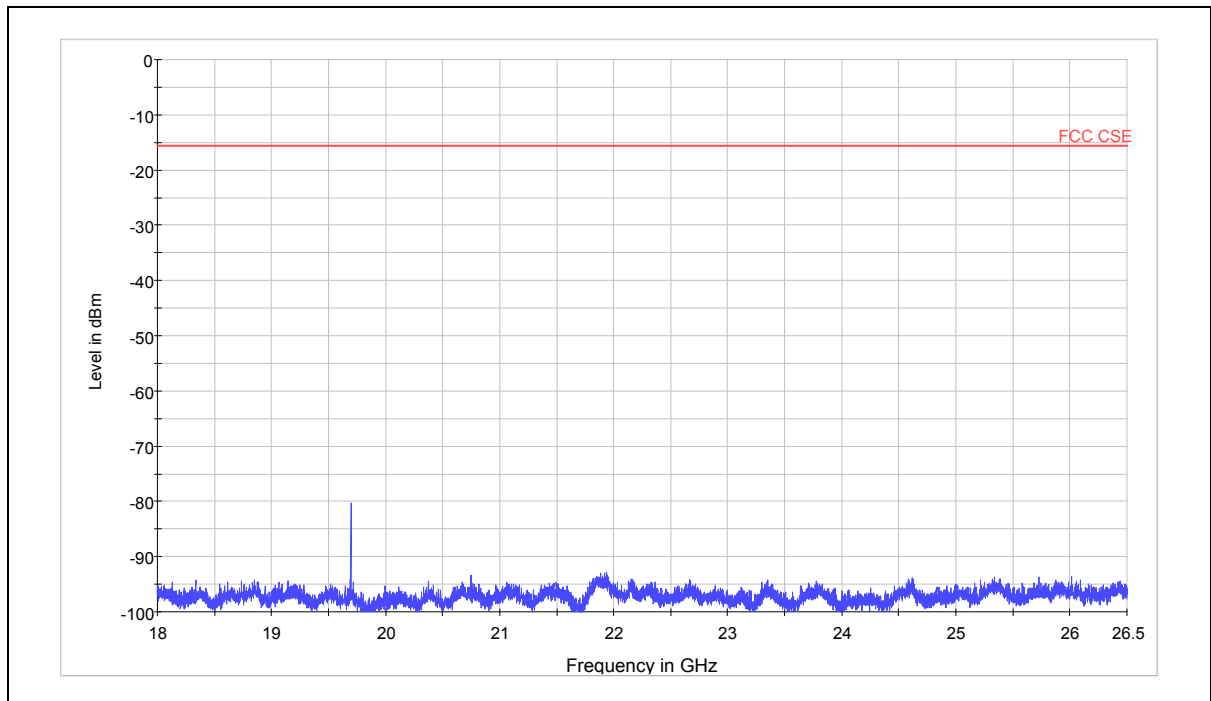

Spurious RF conducted emissions from 18GHz to 26.5GHz

# TA Technology (Shanghai) Co., Ltd. Test Report

Report No.: RXA1409-0216RF01R1

Page 44 of 96

802.11n(HT20) CH1

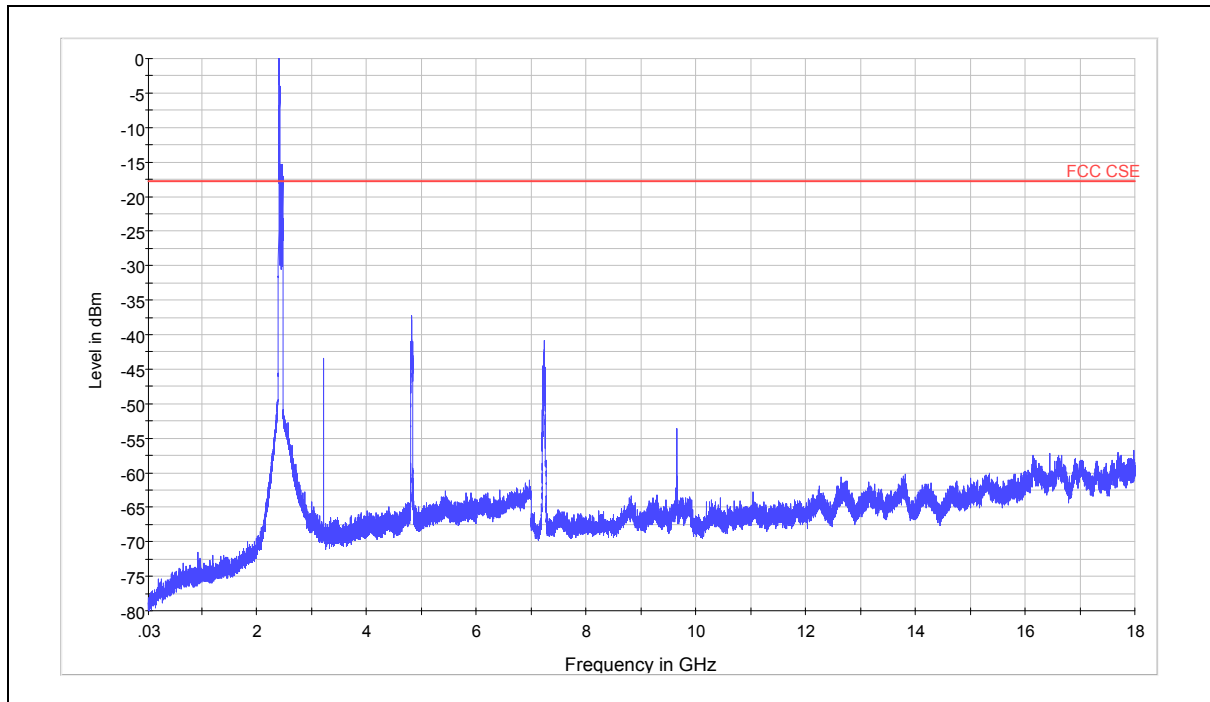

Note: The signal beyond the limit is carrier

Spurious RF conducted emissions from 30MHz to 18GHz

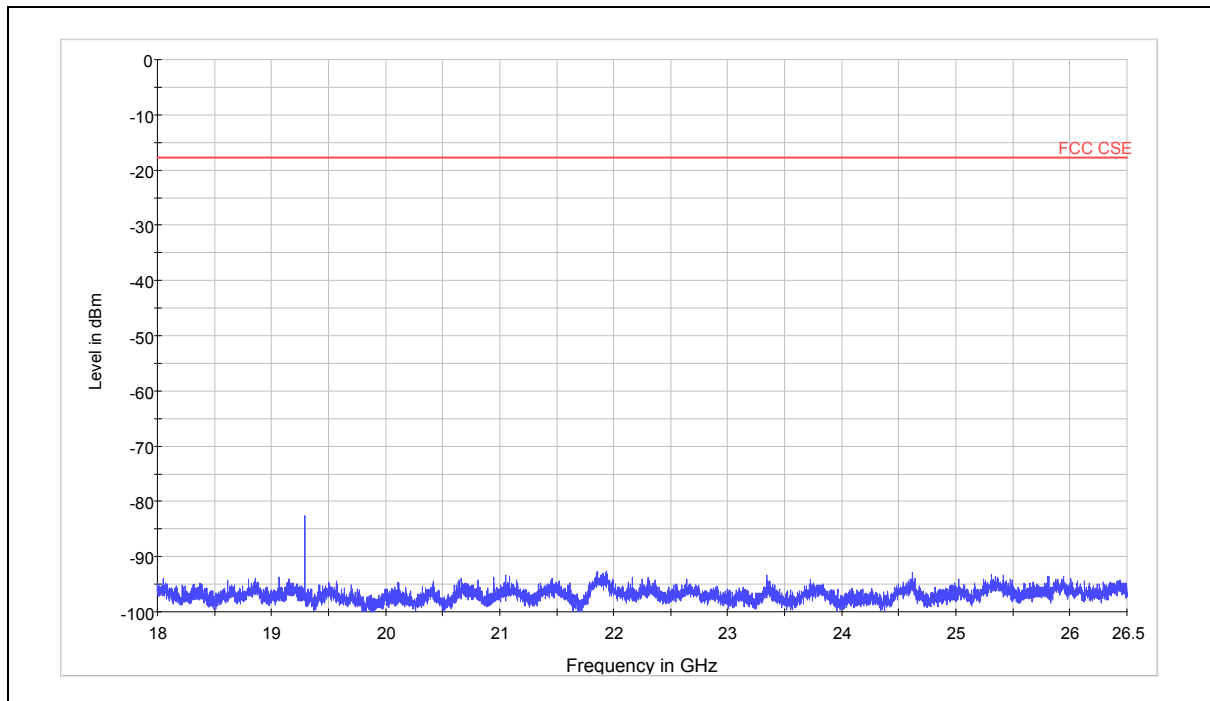

Spurious RF conducted emissions from 18GHz to 26.5GHz

# TA Technology (Shanghai) Co., Ltd. Test Report

Report No.: RXA1409-0216RF01R1

Page 45 of 96

802.11n(HT20) CH6

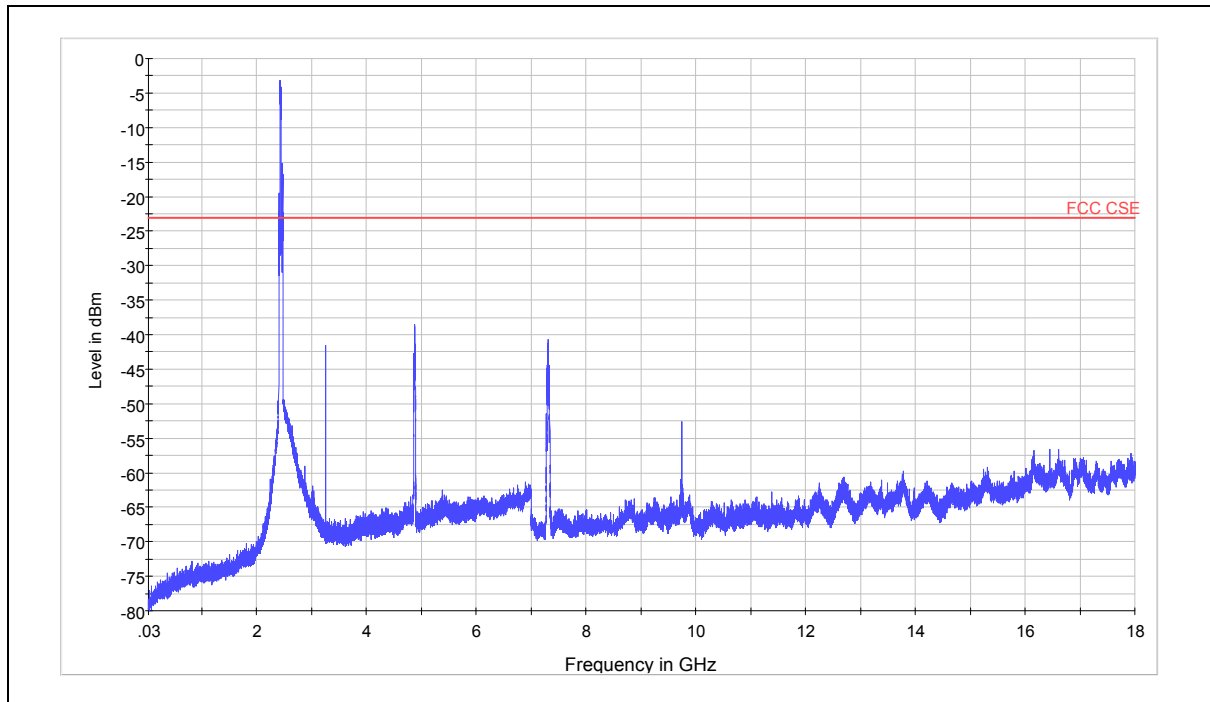

Note: The signal beyond the limit is carrier

Spurious RF conducted emissions from 30MHz to 18GHz

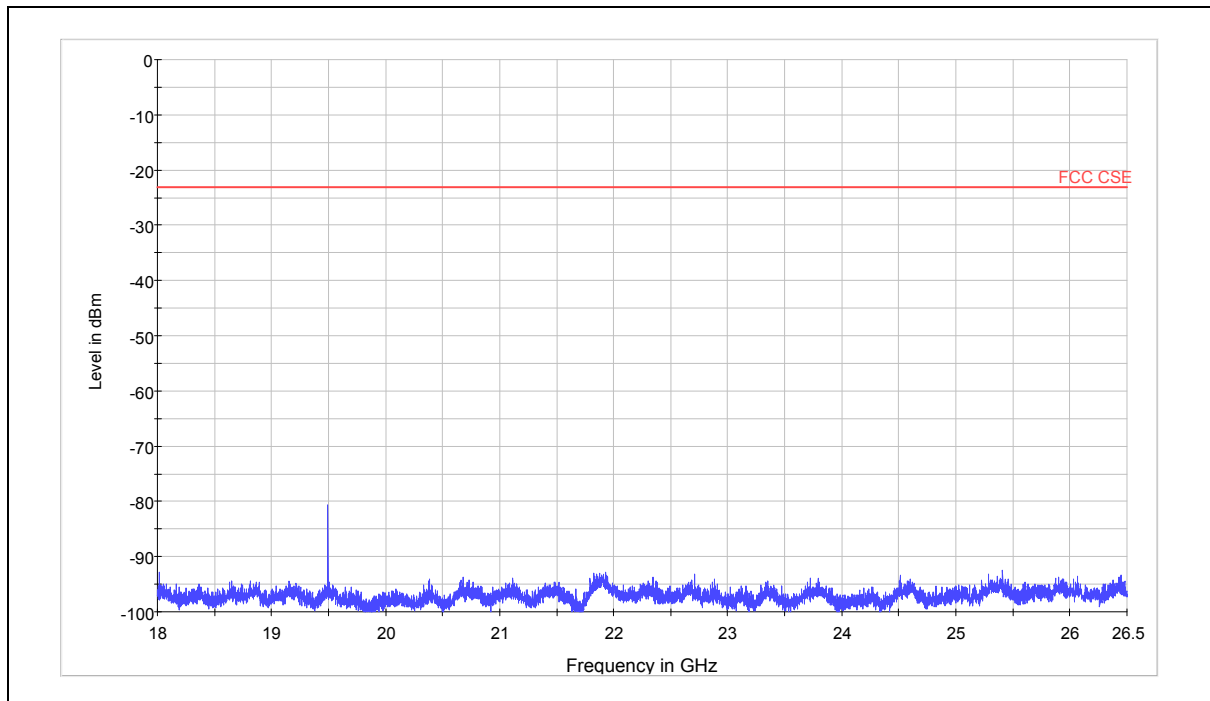

Spurious RF conducted emissions from 18GHz to 26.5GHz

# TA Technology (Shanghai) Co., Ltd. Test Report

Report No.: RXA1409-0216RF01R1

Page 46 of 96

802.11n(HT20) CH11

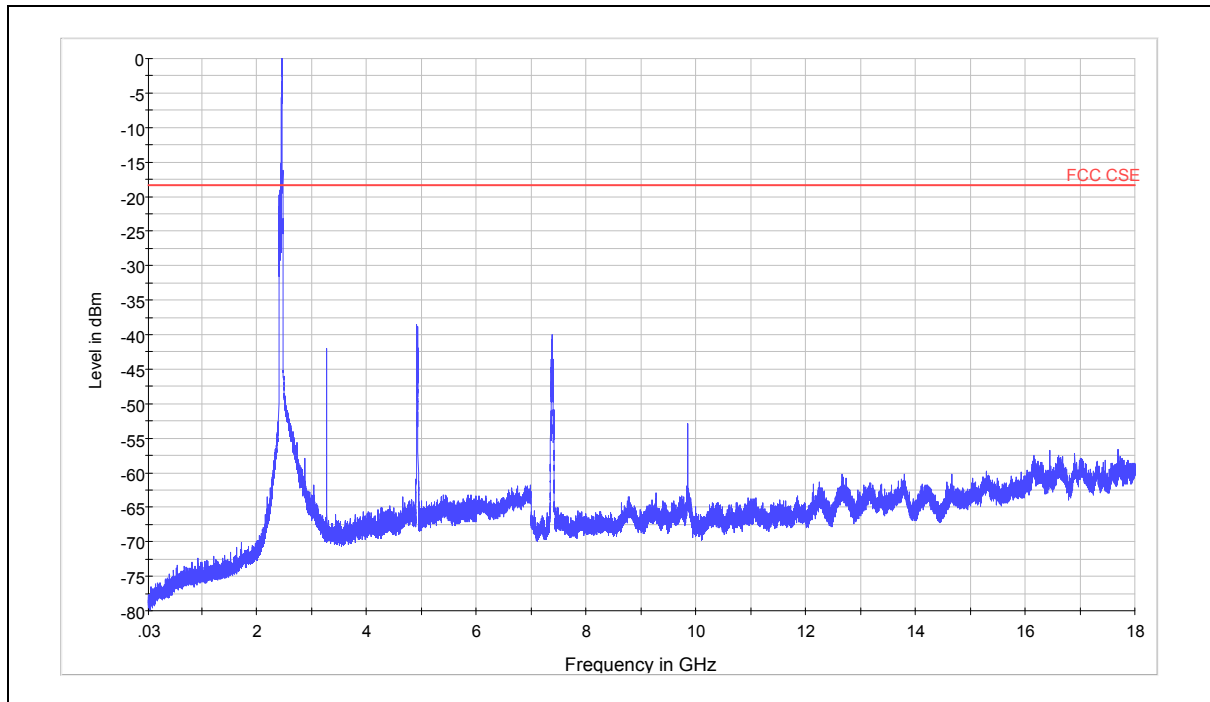

Note: The signal beyond the limit is carrier

Spurious RF conducted emissions from 30MHz to 18GHz

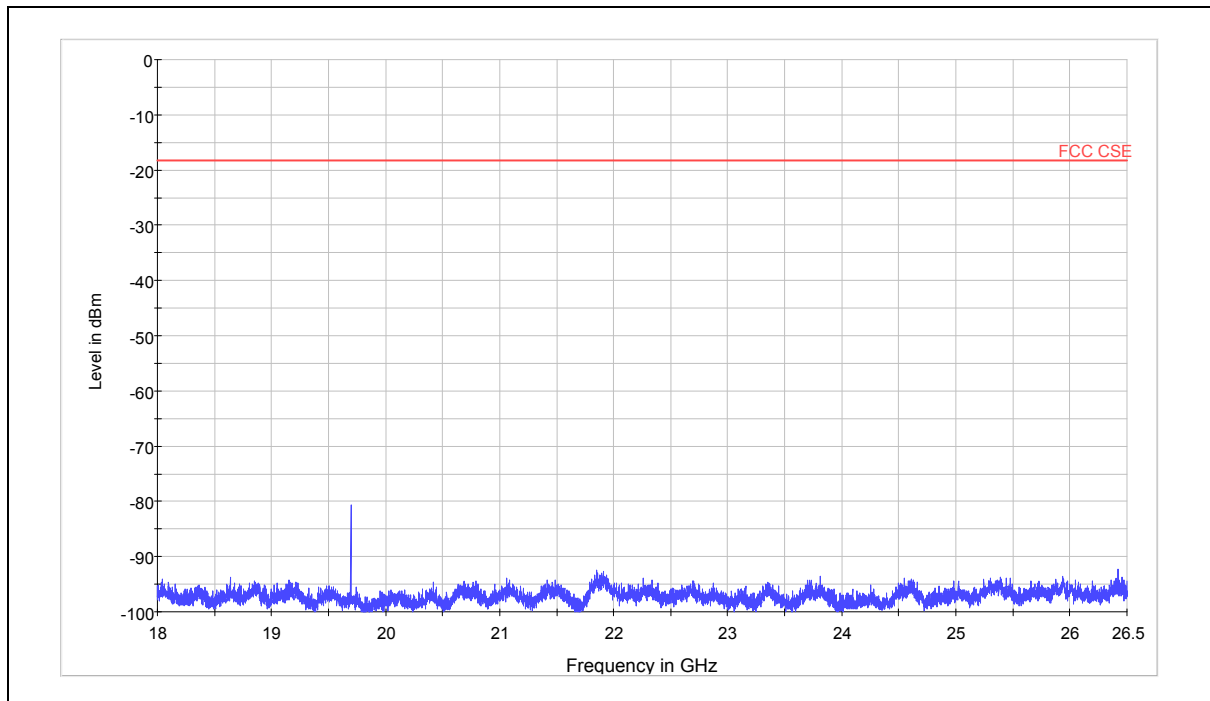

Spurious RF conducted emissions from 18GHz to 26.5GHz

## 2.9. Radiates Emission

### Ambient condition

Temperature	Relative humidity	Pressure
23°C ~25°C	45%~50%	101.5kPa

### Method of Measurement

The test set-up was made in accordance to the general provisions of ANSI C63.4-2009. The Equipment Under Test (EUT) was set up on a non-conductive table in the semi-anechoic chamber. The test was performed at the distance of 3 m between the EUT and the receiving antenna. The radiated emissions measurements were made in a typical installation configuration. Sweep the whole frequency band through the range from 9kHz to the 10th harmonic of the carrier, and the emissions less than 20 dB below the permissible value are reported.

During the test, below 30MHz, the center of the loop shall be 1 meters; above 30MHz, the height of receive antenna shall be moved from 1 to 4 meters and the antenna shall be performed under horizontal and vertical polarization. The turntable shall be rotated from 0 to 360 degrees for detecting the maximum of radiated spurious signal level. The measurements shall be repeated with orthogonal polarization of the test antenna. The data of cable loss and antenna factor has been calibrated in full testing frequency range before the testing.

Set the spectrum analyzer in the following:

Below 1GHz (detector: Peak and Quasi-Peak)

RBW=100kHz / VBW=300kHz / Sweep=AUTO

Above 1GHz(detector: Peak):

(a) PEAK: RBW=1MHz VBW=3MHz/ Sweep=AUTO

(b) AVERAGE: RBW=1MHz / VBW=10Hz / Sweep=AUTO

The radiated emission was measured in the following position: EUT stand-up position (Z axis), lie-down position (X, Y axis). The worst emission was found in lie-down position (X axis) and the worst case was recorded.

The test is in transmitting mode.

# TA Technology (Shanghai) Co., Ltd. Test Report

## Test setup

### 9KHz~~~ 30MHz

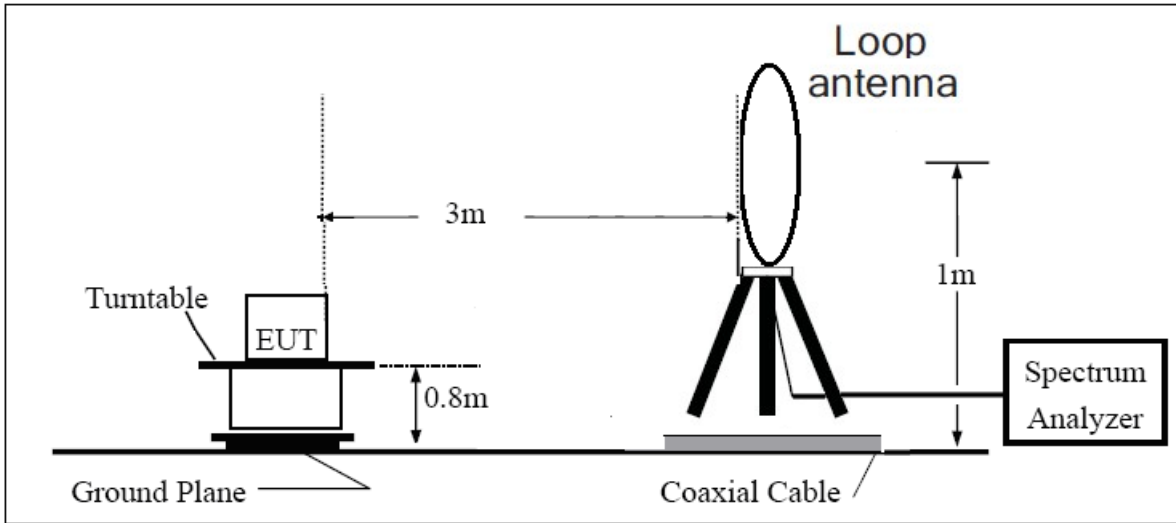

### 30MHz~~~ 1GHz

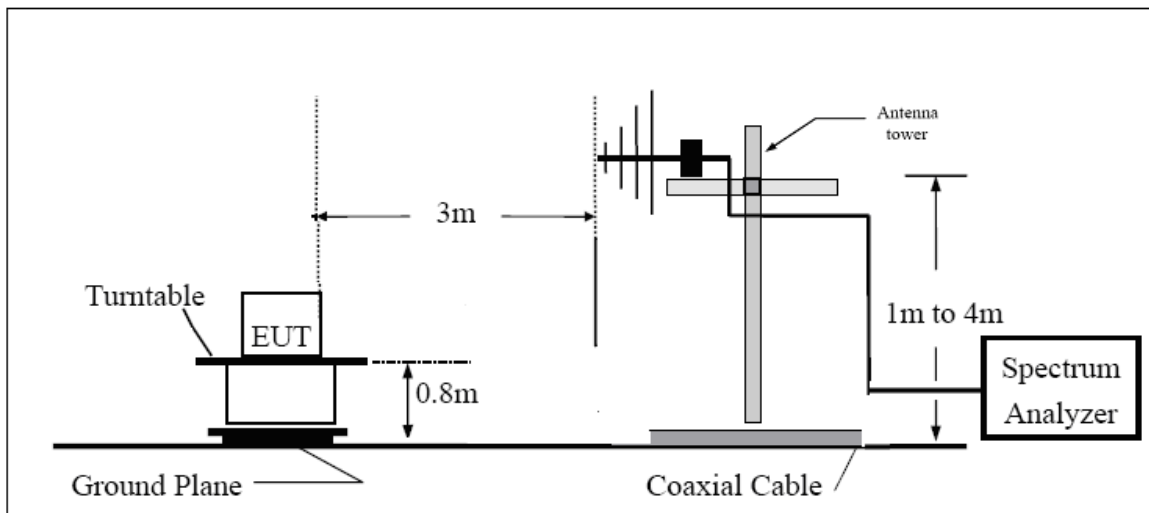

### Above 1GHz

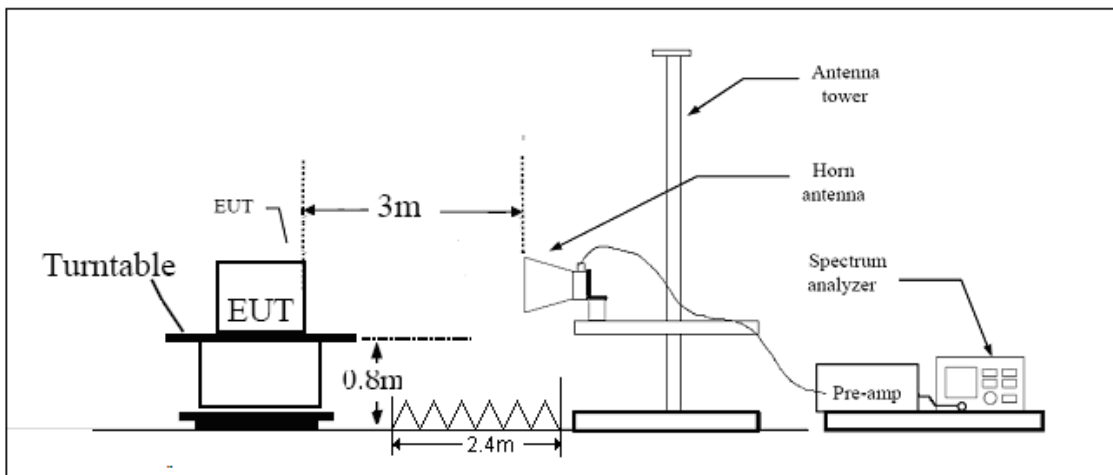

Note: Area side:2.4mX3.6m



# TA Technology (Shanghai) Co., Ltd.

## Test Report

Report No.: RXA1409-0216RF01R1

Page 49 of 96

### Limits

Rule Part 15.247(d) specifies that “In addition, radiated emissions which fall in the restricted bands, as defined in § 15.205(a), must also comply with the radiated emission limits specified in § 15.209(a) (see § 15.205(c)).”

Limit in restricted band

Frequency of emission (MHz)	Field strength(uV/m)	Field strength(dBuV/m)
0.009–0.490	2400/F(kHz)	/
0.490–1.705	24000/F(kHz)	/
1.705–30.0	30	/
30-88	100	40
88-216	150	43.5
216-960	200	46
Above960	500	54

### Measurement Uncertainty

The assessed measurement uncertainty to ensure 95% confidence level for the normal distribution is with the coverage factor  $k = 1.96$ .

Frequency	Uncertainty
9KHz-30MHz	3.55 dB
30MHz-200MHz	4.19 dB
200MHz-1GHz	3.63 dB
Above 1GHz	3.68 dB

# TA Technology (Shanghai) Co., Ltd. Test Report

**Test result**  
**802.11b CH1**

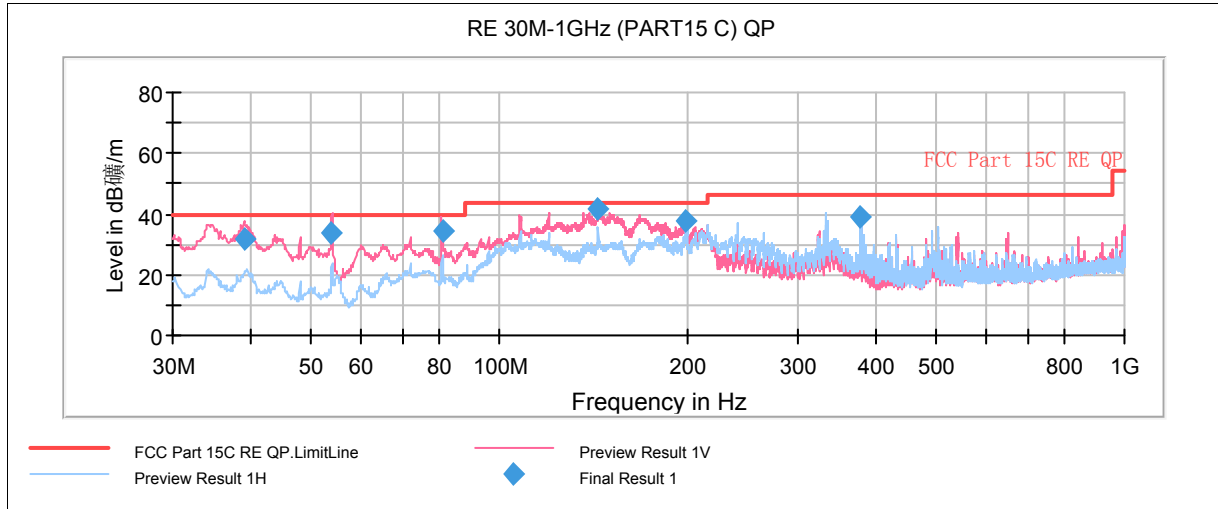

Note: This graph displays the maximum values of horizontal and vertical by software  
 Note: a font ( Level in dB $\mu$ V/m ) in the test plot =(level in dBuV/m)  
 Radiates Emission from 30MHz to 1GHz

Frequency (MHz)	Quasi-Peak (dBuV/m)	Height (cm)	Polarization	Azimuth (deg)	Reading value (dBuV/m)	Correct Factor (dB)	Margin (dB)	Limit (dBuV/m)
39.273750	31.7	100.0	V	27.0	51.0	-19.3	8.3	40.0
53.947500	33.9	100.0	V	45.0	56.3	-22.4	6.1	40.0
81.143750	34.5	125.0	V	6.0	62.4	-27.9	5.5	40.0
143.995000	41.4	121.0	V	7.0	70.6	-29.2	2.1	43.5
199.205000	37.8	100.0	V	166.0	64.2	-26.4	5.7	43.5
377.603750	38.7	100.0	H	249.0	59.7	-21.0	7.3	46.0

- Remark: 1. Quasi-Peak = Reading value + Correction factor**  
**2. Correction Factor = Antenna factor+ Insertion loss(cable loss+amplifier gain)**  
**3. Margin = Limit – Quasi-Peak**

# TA Technology (Shanghai) Co., Ltd. Test Report

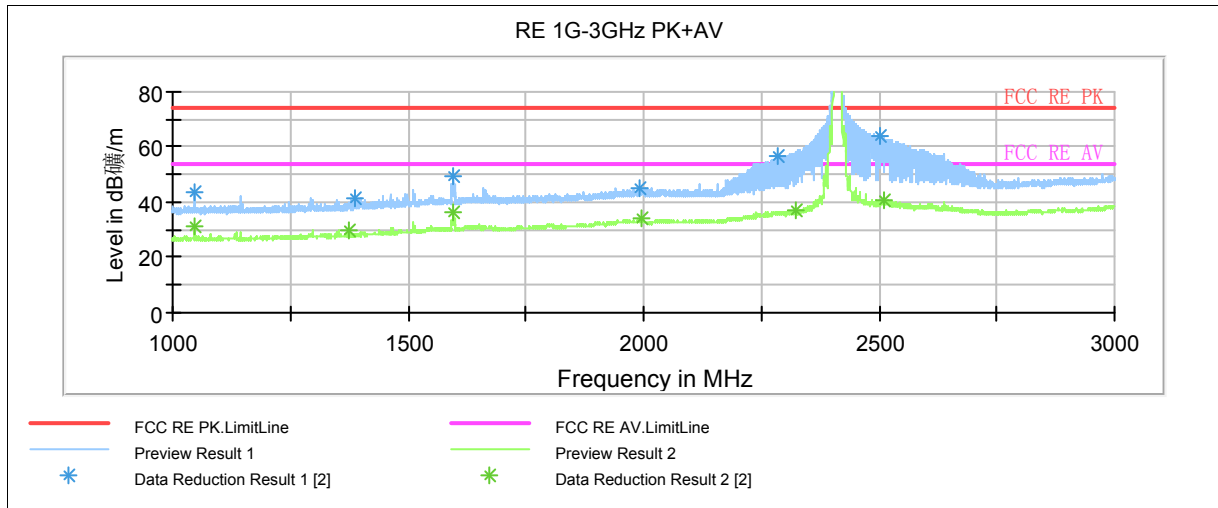

Note: This graph displays the maximum values of horizontal and vertical by software

Note: a font ( Level in dB $\mu$ V/m ) in the test plot =(level in dBuV/m)

Note: The signal beyond the limit is carrier.

Radiates Emission from 1GHz to 3GHz

Frequency (MHz)	Peak (dBuV/m)	Height (cm)	Polarization	Azimuth (deg)	Reading value (dBuV/m)	Correct Factor (dB)	Margin (dB)	Limit (dBuV/m)
1046.250000	43.9	100.0	V	315.0	53.8	-9.9	30.1	74
1388.750000	41.5	100.0	V	333.0	49.8	-8.3	32.5	74
1594.000000	49.7	100.0	V	322.0	56.4	-6.7	24.3	74
1993.500000	45.3	100.0	V	293.0	48.3	-3.0	28.7	74
2283.750000	56.9	100.0	V	18.0	59.1	-2.2	17.1	74
2500.750000	64.0	100.0	V	38.0	64.9	-0.9	10.0	74

Remark: 1. Correction Factor = Antenna factor+ Insertion loss (cable loss + amplifier gain)

Frequency (MHz)	Average (dBuV/m)	Height (cm)	Polarization	Azimuth (deg)	Reading value (dBuV/m)	Correct Factor (dB)	Margin (dB)	Limit (dBuV/m)
1046.250000	31.6	100.0	V	315.0	41.5	-9.9	22.4	54
1374.500000	29.9	100.0	V	0.0	38.4	-8.5	24.1	54
1594.750000	36.3	100.0	V	307.0	43.0	-6.7	17.7	54
1994.500000	33.8	100.0	V	0.0	36.7	-2.9	20.2	54
2324.750000	37.1	100.0	V	0.0	39.6	-2.5	16.9	54
2510.750000	40.7	100.0	V	293.0	41.6	-0.9	13.3	54

Remark: 1. Correction Factor = Antenna factor+ Insertion loss (cable loss + amplifier gain)

# TA Technology (Shanghai) Co., Ltd. Test Report

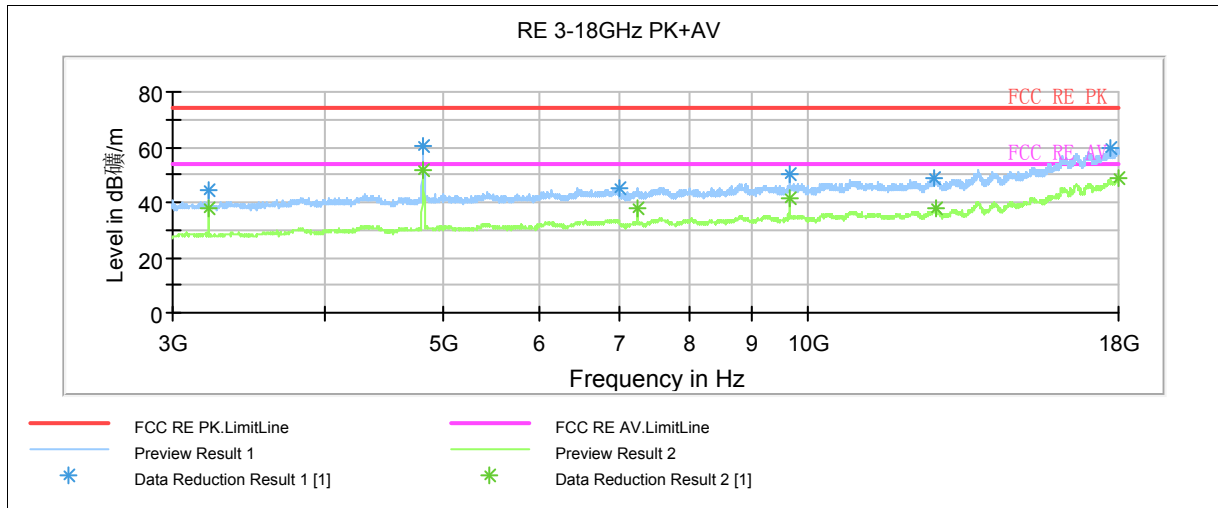

Note: This graph displays the maximum values of horizontal and vertical by software

Note: a font ( Level in dBμV/m ) in the test plot =(level in dBuV/m)

Note: The signal beyond the limit is harmonic of carrier.

Radiates Emission from 3GHz to 18GHz

Frequency (MHz)	Peak (dBuV/m)	Height (cm)	Polarization	Azimuth (deg)	Reading value (dBuV/m)	Correct Factor (dB)	Margin (dB)	Limit (dBuV/m)
3215.625000	44.5	200.0	V	292.0	47.2	-2.7	29.5	74
4822.500000	60.4	200.0	V	22.0	62.3	-1.9	13.6	74
7237.500000	44.2	100.0	H	0.0	50.3	-6.1	29.8	74
9648.750000	49.2	100.0	H	0.0	58.0	-8.8	24.8	74
12738.750000	46.8	200.0	V	101.0	59.4	-12.6	27.2	74
18000.000000	57.6	200.0	H	284.0	81.1	-23.5	16.4	74

**Remark: 1. Correction Factor = Antenna factor+ Insertion loss (cable loss + amplifier gain)**

Frequency (MHz)	Average (dBuV/m)	Height (cm)	Polarization	Azimuth (deg)	Reading value (dBuV/m)	Correct Factor (dB)	Margin (dB)	Limit (dBuV/m)
3215.625000	38.1	200.0	V	292.0	40.8	-2.7	15.9	54
4822.500000	51.6	200.0	V	22.0	53.5	-1.9	2.4	54
7237.500000	37.7	100.0	H	0.0	43.8	-6.1	16.3	54
9648.750000	41.2	100.0	H	0.0	50.0	-8.8	12.8	54
12738.750000	37.7	200.0	V	101.0	50.3	-12.6	16.3	54
18000.000000	48.4	200.0	H	284.0	71.9	-23.5	5.6	54

**Remark: 1. Correction Factor = Antenna factor+ Insertion loss (cable loss + amplifier gain)**

# TA Technology (Shanghai) Co., Ltd. Test Report

Report No.: RXA1409-0216RF01R1

Page 53of 96

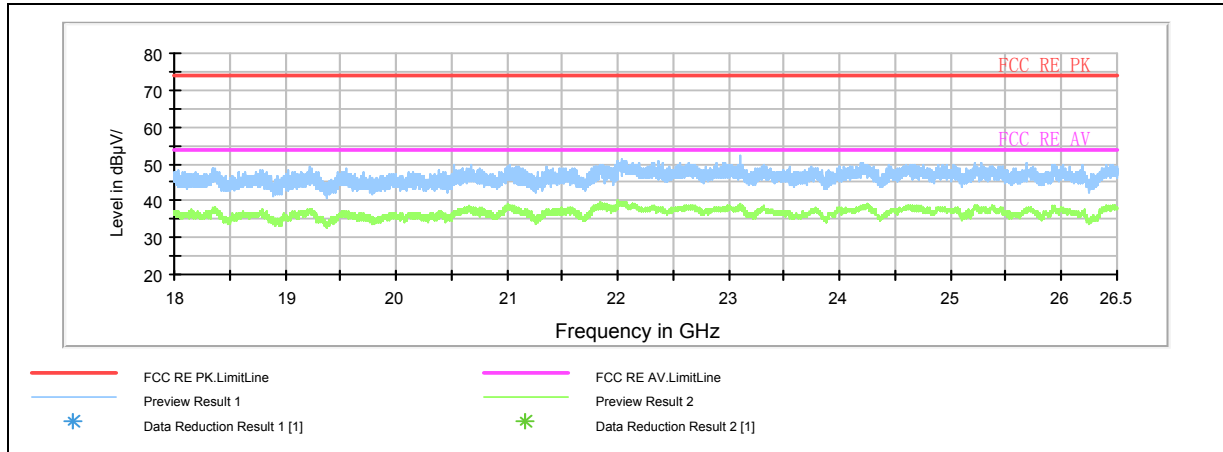

Note: This graph displays the maximum values of horizontal and vertical by software

Note: a font ( Level in dBuV/m )in the test plot =(level in dBuV/m)

Radiates Emission from 18GHz to 26.5GHz

# TA Technology (Shanghai) Co., Ltd. Test Report

## 802.11b CH6

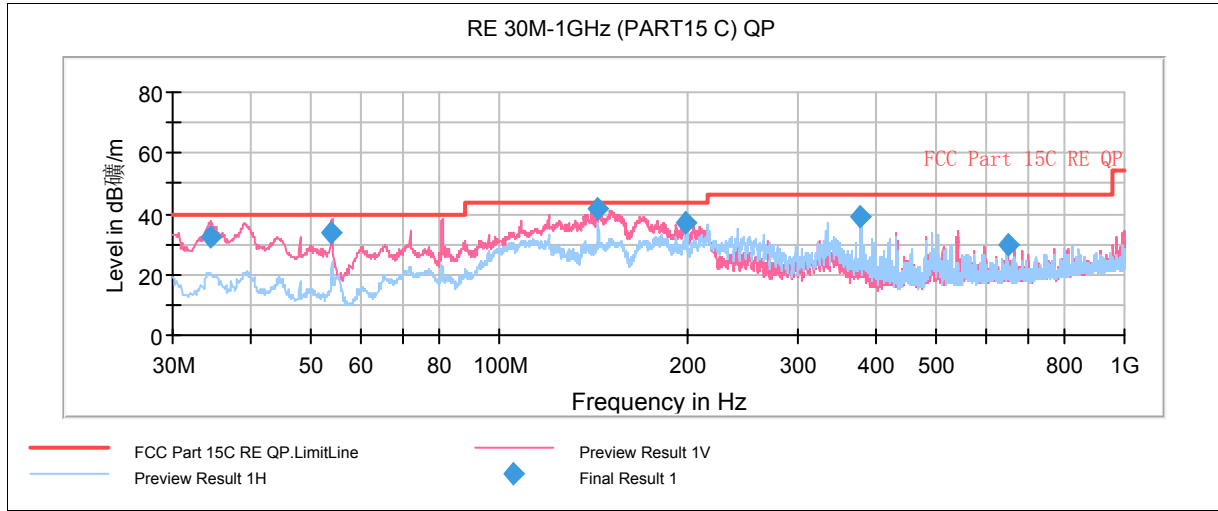

Note: This graph displays the maximum values of horizontal and vertical by software

Note: a font ( Level in dB $\mu$ V/m ) in the test plot =(level in dBuV/m)

Radiates Emission from 30MHz to 1GHz

Frequency (MHz)	Quasi-Peak (dBuV/m)	Height (cm)	Polarization	Azimuth (deg)	Reading value (dBuV/m)	Correct Factor (dB)	Margin (dB)	Limit (dBuV/m)
34.507500	32.6	100.0	V	337.0	51.6	-19.0	7.4	40.0
53.947500	33.5	100.0	V	35.0	55.9	-22.4	6.5	40.0
143.995000	41.4	100.0	V	337.0	70.6	-29.2	2.1	43.5
199.203750	36.8	100.0	V	152.0	63.2	-26.4	6.7	43.5
377.602500	38.9	100.0	H	240.0	59.9	-21.0	7.1	46.0
649.446250	29.9	100.0	V	209.0	45.6	-15.7	16.1	46.0

**Remark: 1. Quasi-Peak = Reading value + Correction factor**

**2. Correction Factor = Antenna factor+ Insertion loss(cable loss+amplifier gain)**

**3. Margin = Limit – Quasi-Peak**

# TA Technology (Shanghai) Co., Ltd. Test Report

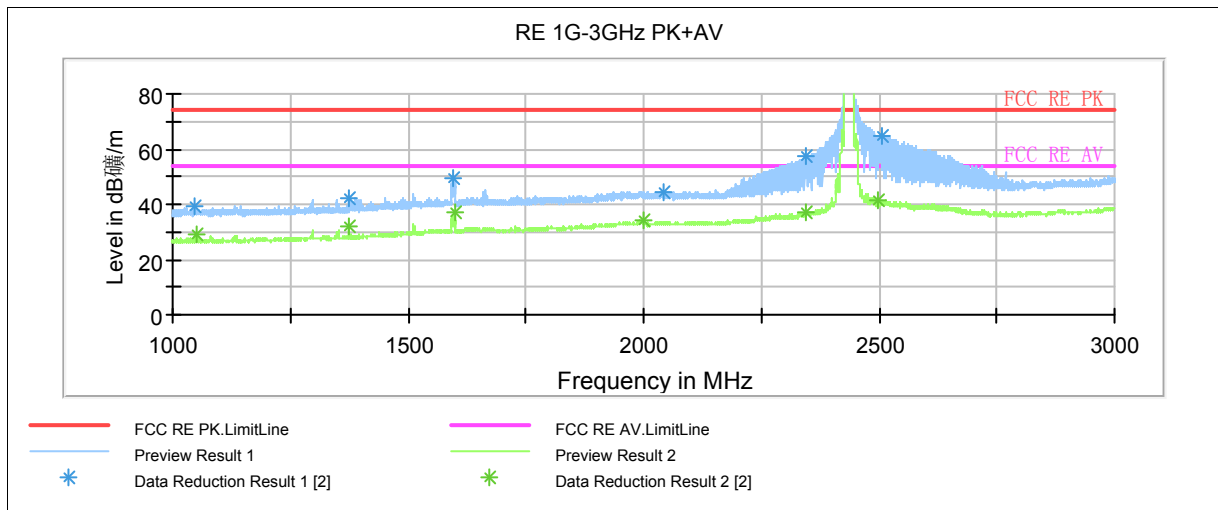

Note: This graph displays the maximum values of horizontal and vertical by software

Note: a font ( Level in dBμV/m ) in the test plot =(level in dBuV/m)

Note: The signal beyond the limit is carrier.

Radiates Emission from 1GHz to 3GHz

Frequency (MHz)	Peak (dBuV/m)	Height (cm)	Polarization	Azimuth (deg)	Reading value (dBuV/m)	Correct Factor (dB)	Margin (dB)	Limit (dBuV/m)
1046.250000	39.1	100.0	H	266.0	49.0	-9.9	34.9	74
1375.500000	42.3	100.0	V	37.0	50.7	-8.4	31.7	74
1593.750000	49.4	100.0	V	327.0	56.1	-6.7	24.6	74
2043.250000	44.7	100.0	H	171.0	47.7	-3.0	29.3	74
2344.750000	57.7	100.0	V	341.0	59.8	-2.1	16.3	74
2506.500000	64.9	100.0	V	46.0	65.8	-0.9	9.1	74

Remark: 1. Correction Factor = Antenna factor+ Insertion loss (cable loss + amplifier gain)

Frequency (MHz)	Average (dBuV/m)	Height (cm)	Polarization	Azimuth (deg)	Reading value (dBuV/m)	Correct Factor (dB)	Margin (dB)	Limit (dBuV/m)
1050.500000	29.2	100.0	H	299.0	39.1	-9.9	24.8	54
1375.000000	32.3	100.0	V	282.0	40.8	-8.5	21.7	54
1598.000000	37.2	100.0	V	18.0	43.9	-6.7	16.8	54
1998.750000	34.1	100.0	V	0.0	37.1	-3.0	19.9	54
2344.750000	36.8	100.0	V	341.0	38.9	-2.1	17.2	54
2499.250000	41.2	100.0	V	86.0	42.0	-0.8	12.8	54

Remark: 1. Correction Factor = Antenna factor+ Insertion loss (cable loss + amplifier gain)

# TA Technology (Shanghai) Co., Ltd. Test Report

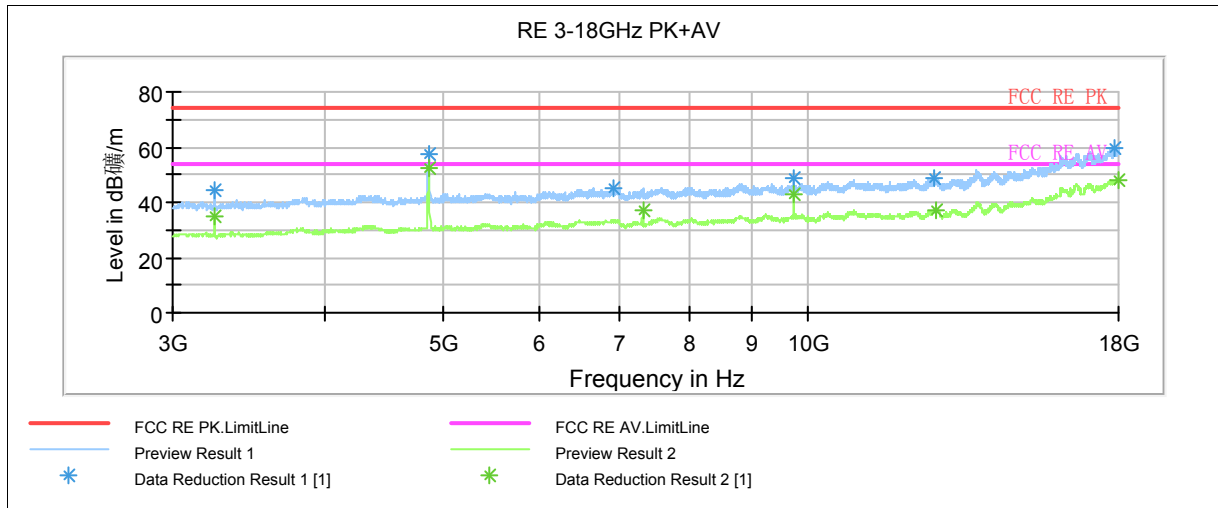

Note: This graph displays the maximum values of horizontal and vertical by software

Note: a font ( Level in dBμV/m ) in the test plot =(level in dBuV/m)

Radiates Emission from 3GHz to 18GHz

Frequency (MHz)	Peak (dBuV/m)	Height (cm)	Polarization	Azimuth (deg)	Reading value (dBuV/m)	Correct Factor (dB)	Margin (dB)	Limit (dBuV/m)
3247.500000	44.1	200.0	V	289.0	46.4	-2.3	29.9	74
4873.125000	57.1	200.0	V	24.0	59.0	-1.9	16.9	74
7312.500000	44.1	200.0	V	63.0	49.8	-5.7	29.9	74
9748.125000	48.8	100.0	H	0.0	57.6	-8.8	25.2	74
12727.500000	47.4	100.0	H	118.0	60.0	-12.6	26.6	74
17966.250000	57.2	100.0	V	347.0	80.6	-23.4	16.8	74

**Remark: 1. Correction Factor = Antenna factor+ Insertion loss (cable loss + amplifier gain)**

Frequency (MHz)	Average (dBuV/m)	Height (cm)	Polarization	Azimuth (deg)	Reading value (dBuV/m)	Correct Factor (dB)	Margin (dB)	Limit (dBuV/m)
3247.500000	34.7	200.0	V	289.0	37.0	-2.3	19.3	54
4873.125000	52.3	200.0	V	24.0	54.2	-1.9	1.7	54
7312.500000	37.0	200.0	V	63.0	42.7	-5.7	17.0	54
9748.125000	42.7	100.0	H	0.0	51.5	-8.8	11.3	54
12727.500000	37.4	100.0	H	118.0	50.0	-12.6	16.6	54
17966.250000	48.3	100.0	V	347.0	71.7	-23.4	5.7	54

**Remark: 1. Correction Factor = Antenna factor+ Insertion loss (cable loss + amplifier gain)**



# TA Technology (Shanghai) Co., Ltd. Test Report

Report No.: RXA1409-0216RF01R1

Page 57 of 96

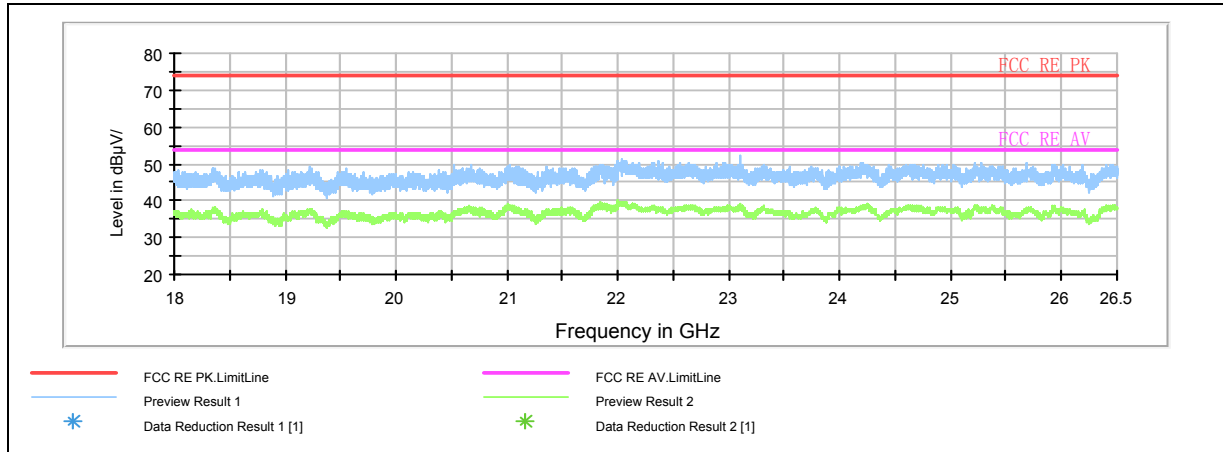

Note: This graph displays the maximum values of horizontal and vertical by software

Note: a font ( Level in dBuV/m ) in the test plot =(level in dBuV/m)

Radiates Emission from 18GHz to 26.5GHz

# TA Technology (Shanghai) Co., Ltd. Test Report

Report No.: RXA1409-0216RF01R1

Page 58 of 96

## 802.11b CH11

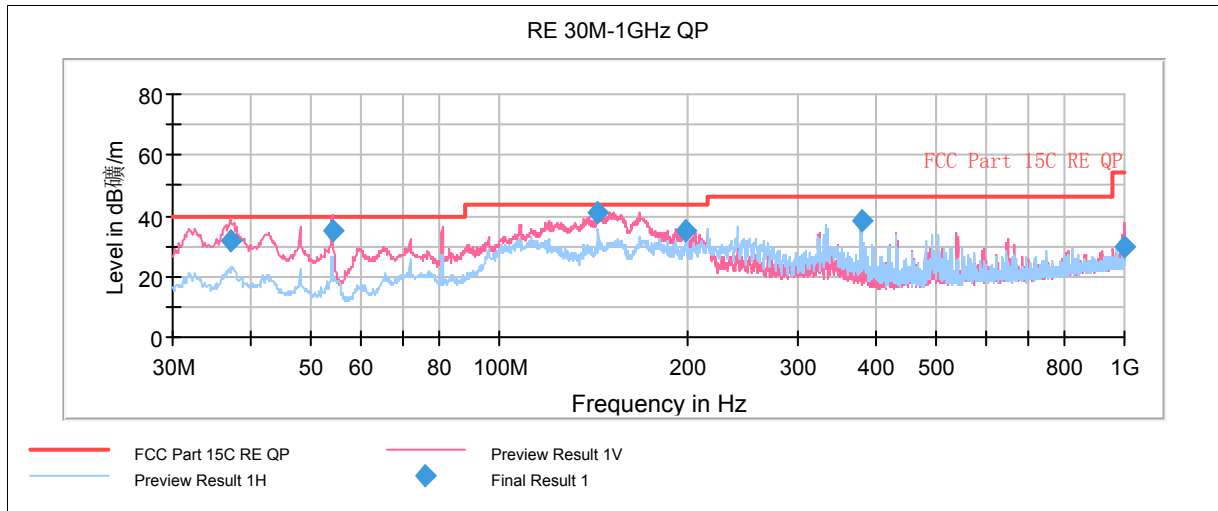

Note: This graph displays the maximum values of horizontal and vertical by software

Note: a font ( Level in dB $\mu$ V/m ) in the test plot =(level in dBuV/m)

Radiates Emission from 30MHz to 1GHz

Frequency (MHz)	Quasi-Peak (dBuV/m)	Height (cm)	Polarization	Azimuth (deg)	Reading value (dBuV/m)	Correct Factor (dB)	Margin (dB)	Limit (dBuV/m)
37.125081	32.0	100.0	V	120.0	51.3	-19.3	8.0	40
53.952481	34.9	120.0	V	92.0	57.2	-22.3	5.1	40
143.975062	41.1	100.0	V	176.0	70.5	-29.4	2.4	43.5
199.205890	35.3	100.0	V	164.0	62.0	-26.7	8.2	43.5
378.808000	38.2	100.0	H	245.0	59.6	-21.4	7.8	46
999.175250	30.0	121.0	V	346.0	41.6	-11.6	24	54

Remark: 1. Quasi-Peak = Reading value + Correction factor

2. Correction Factor = Antenna factor+ Insertion loss(cable loss+amplifier gain)

3. Margin = Limit – Quasi-Peak

# TA Technology (Shanghai) Co., Ltd. Test Report

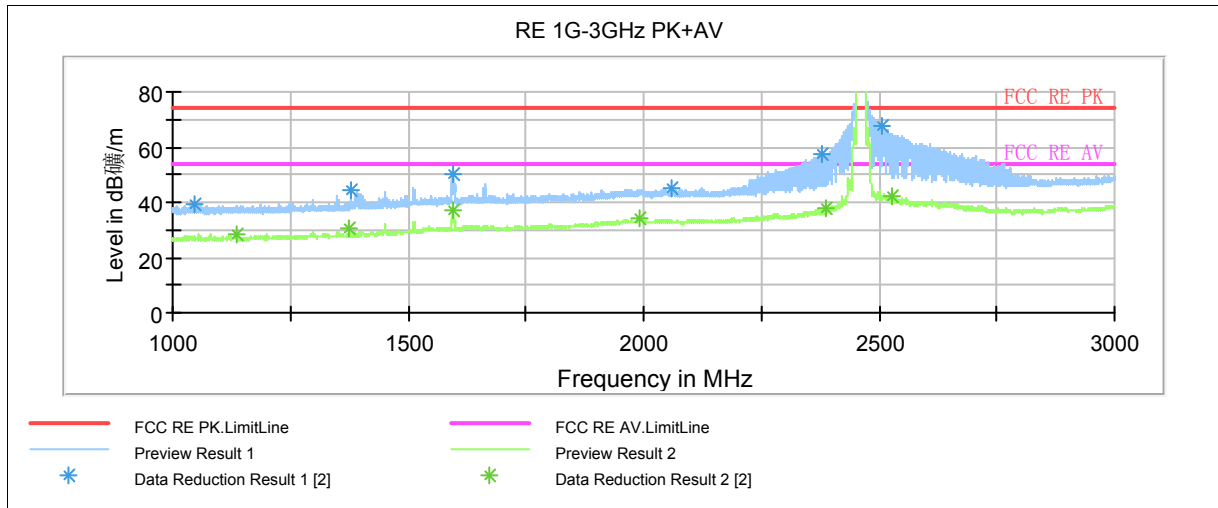

Note: This graph displays the maximum values of horizontal and vertical by software

Note: a font ( Level in dB $\mu$ V/m ) in the test plot =(level in dBuV/m)

Note: The signal beyond the limit is carrier.

Radiates Emission from 1GHz to 3GHz

Frequency (MHz)	Peak (dBuV/m)	Height (cm)	Polarization	Azimuth (deg)	Reading value (dBuV/m)	Correct Factor (dB)	Margin (dB)	Limit (dBuV/m)
1047.500000	39.4	100.0	H	241.0	49.3	-9.9	34.6	74
1378.250000	44.2	100.0	V	272.0	52.6	-8.4	29.8	74
1593.750000	50.3	100.0	V	316.0	57.0	-6.7	23.7	74
2061.500000	44.8	100.0	V	331.0	47.8	-3.0	29.2	74
2377.000000	57.6	100.0	V	38.0	59.9	-2.3	16.4	74
2505.250000	67.8	100.0	V	38.0	68.7	-0.9	6.2	74

Remark: 1. Correction Factor = Antenna factor+ Insertion loss (cable loss + amplifier gain)

Frequency (MHz)	Average (dBuV/m)	Height (cm)	Polarization	Azimuth (deg)	Reading value (dBuV/m)	Correct Factor (dB)	Margin (dB)	Limit (dBuV/m)
1136.250000	28.4	100.0	V	359.0	38.1	-9.7	25.6	54
1374.750000	30.5	100.0	V	47.0	39.0	-8.5	23.5	54
1595.750000	37.1	100.0	V	309.0	43.8	-6.7	16.9	54
1993.500000	33.9	100.0	H	0.0	36.9	-3.0	20.1	54
2389.250000	37.7	100.0	V	38.0	39.9	-2.2	16.3	54
2528.000000	42.2	100.0	V	28.0	43.2	-1.0	11.8	54

Remark: 1. Correction Factor = Antenna factor+ Insertion loss (cable loss + amplifier gain)

# TA Technology (Shanghai) Co., Ltd. Test Report

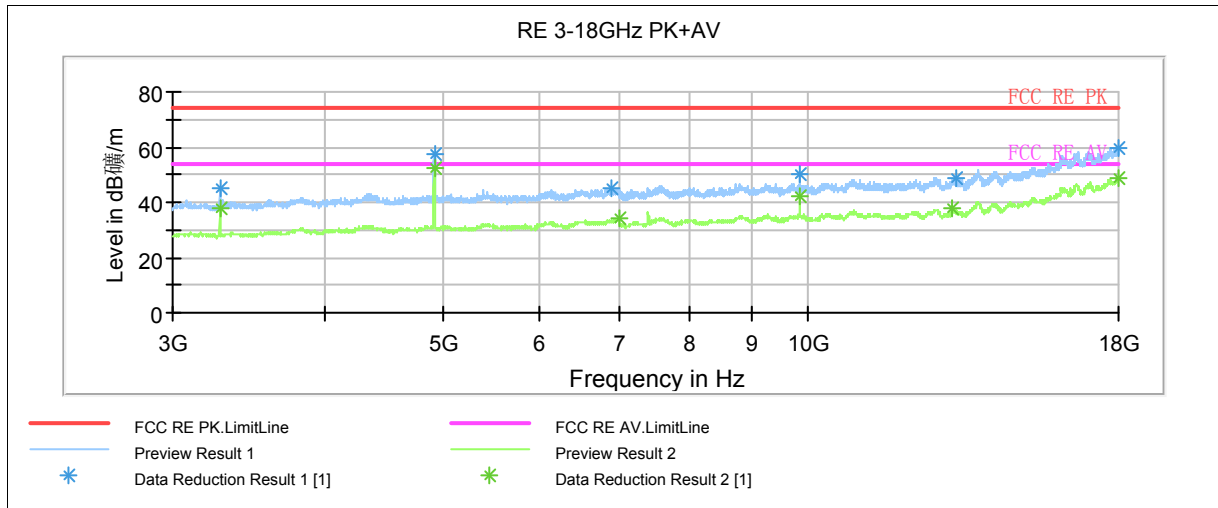

Note: This graph displays the maximum values of horizontal and vertical by software

Note: a font ( Level in dB $\mu$ V/m ) in the test plot =(level in dBuV/m)

Radiates Emission from 3GHz to 18GHz

Frequency (MHz)	Peak (dBuV/m)	Height (cm)	Polarization	Azimuth (deg)	Reading value (dBuV/m)	Correct Factor (dB)	Margin (dB)	Limit (dBuV/m)
3281.250000	44.6	200.0	V	261.0	46.9	-2.3	29.4	74
4923.750000	57.3	200.0	V	37.0	59.2	-1.9	16.7	74
6997.500000	43.5	200.0	V	11.0	48.5	-5.0	30.5	74
9847.500000	50.0	100.0	H	0.0	59.8	-9.8	24.0	74
13147.500000	47.0	200.0	V	115.0	59.7	-12.7	27.0	74
17998.125000	58.2	200.0	V	141.0	81.7	-23.5	15.8	74

**Remark: 1. Correction Factor = Antenna factor+ Insertion loss (cable loss + amplifier gain)**

Frequency (MHz)	Average (dBuV/m)	Height (cm)	Polarization	Azimuth (deg)	Reading value (dBuV/m)	Correct Factor (dB)	Margin (dB)	Limit (dBuV/m)
3281.250000	38.1	200.0	V	261.0	40.4	-2.3	15.9	54
4923.750000	52.4	200.0	V	37.0	54.3	-1.9	1.6	54
6997.500000	33.9	200.0	V	11.0	38.9	-5.0	20.1	54
9847.500000	42.2	100.0	H	0.0	52.0	-9.8	11.8	54
13147.500000	37.5	200.0	V	115.0	50.2	-12.7	16.5	54
17998.125000	48.4	200.0	V	141.0	71.9	-23.5	5.6	54

**Remark: 1. Correction Factor = Antenna factor+ Insertion loss (cable loss + amplifier gain)**

# TA Technology (Shanghai) Co., Ltd. Test Report

Report No.: RXA1409-0216RF01R1

Page 61 of 96

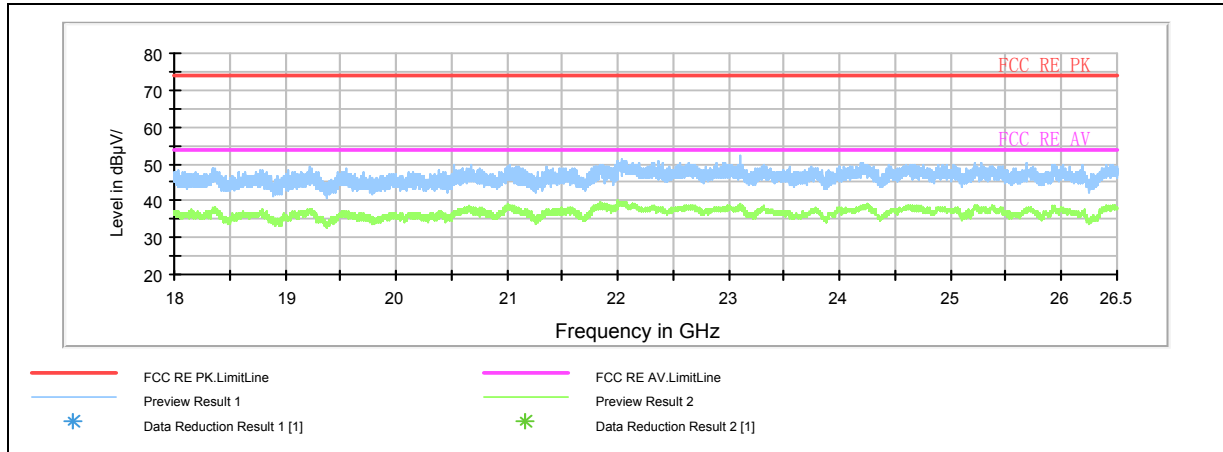

Note: This graph displays the maximum values of horizontal and vertical by software

Note: a font ( Level in dBuV/m ) in the test plot =(level in dBuV/m)

Radiates Emission from 18GHz to 26.5GHz

# TA Technology (Shanghai) Co., Ltd. Test Report

## 802.11g CH1

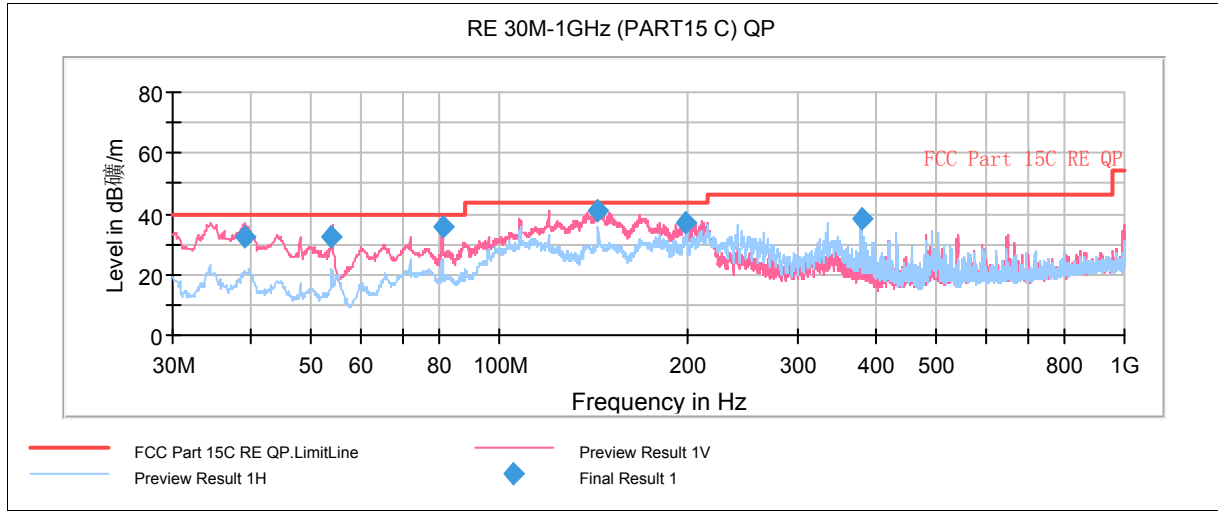

Note: This graph displays the maximum values of horizontal and vertical by software

Note: a font ( Level in dB $\mu$ V/m ) in the test plot =(level in dBuV/m)

Radiates Emission from 30MHz to 1GHz

Frequency (MHz)	Quasi-Peak (dBuV/m)	Height (cm)	Polarization	Azimuth (deg)	Reading value (dBuV/m)	Correct Factor (dB)	Margin (dB)	Limit (dBuV/m)
39.275000	32.2	100.0	V	7.0	51.5	-19.3	7.8	40.0
53.947500	32.1	100.0	V	88.0	54.5	-22.4	7.9	40.0
81.145000	35.7	125.0	V	0.0	63.6	-27.9	4.3	40.0
143.995000	40.9	100.0	V	330.0	70.1	-29.2	2.6	43.5
199.203750	36.8	100.0	V	349.0	63.2	-26.4	6.7	43.5
378.810000	38.2	100.0	H	249.0	59.1	-20.9	7.8	46.0

Remark: 1. Quasi-Peak = Reading value + Correction factor

2. Correction Factor = Antenna factor+ Insertion loss(cable loss+amplifier gain)

3. Margin = Limit – Quasi-Peak

# TA Technology (Shanghai) Co., Ltd. Test Report

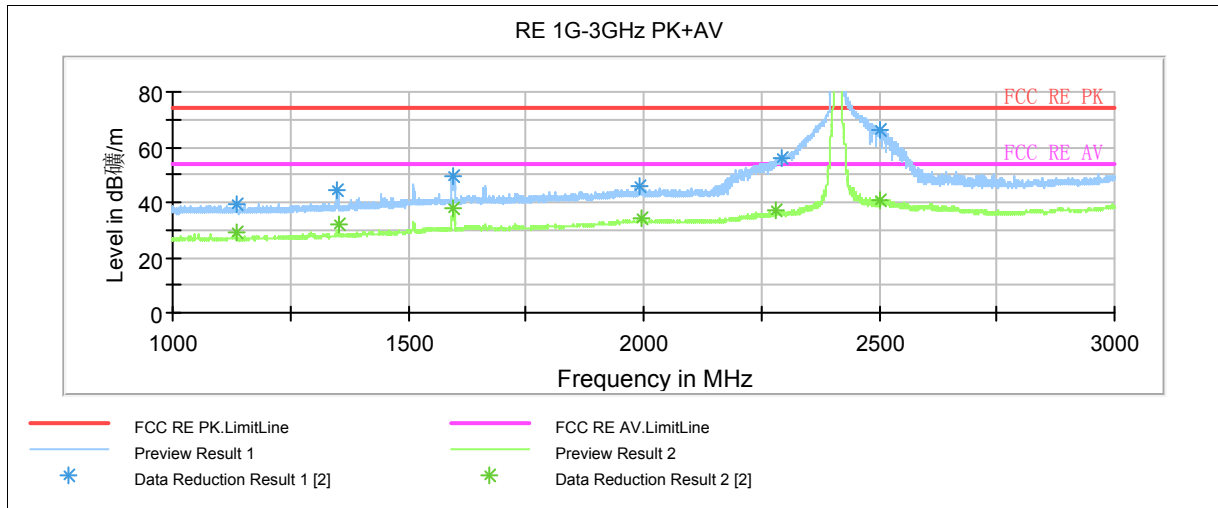

Note: This graph displays the maximum values of horizontal and vertical by software

Note: a font ( Level in dBμV/m ) in the test plot =(level in dBuV/m)

Note: The signal beyond the limit is carrier.

Radiates Emission from 1GHz to 3GHz

Frequency (MHz)	Peak (dBuV/m)	Height (cm)	Polarization	Azimuth (deg)	Reading value (dBuV/m)	Correct Factor (dB)	Margin (dB)	Limit (dBuV/m)
1136.500000	39.5	100.0	V	0.0	49.2	-9.7	34.5	74
1349.250000	44.3	100.0	V	28.0	53.2	-8.9	29.7	74
1594.750000	49.1	100.0	V	325.0	55.8	-6.7	24.9	74
1992.750000	46.0	100.0	V	341.0	49.0	-3.0	28.0	74
2293.000000	56.3	100.0	V	0.0	58.9	-2.6	17.7	74
2503.250000	66.2	100.0	V	46.0	67.1	-0.9	7.8	74

Remark: 1. Correction Factor = Antenna factor+ Insertion loss (cable loss + amplifier gain)

Frequency (MHz)	Average (dBuV/m)	Height (cm)	Polarization	Azimuth (deg)	Reading value (dBuV/m)	Correct Factor (dB)	Margin (dB)	Limit (dBuV/m)
1134.750000	28.7	100.0	V	0.0	38.4	-9.7	25.3	54
1352.250000	32.3	100.0	V	28.0	41.2	-8.9	21.7	54
1595.500000	37.9	100.0	V	318.0	44.6	-6.7	16.1	54
1994.250000	34.0	100.0	H	0.0	36.9	-2.9	20.0	54
2279.250000	36.8	100.0	V	28.0	38.9	-2.1	17.2	54
2504.000000	41.0	100.0	V	37.0	41.9	-0.9	13.0	54

Remark: 1. Correction Factor = Antenna factor+ Insertion loss (cable loss + amplifier gain)

# TA Technology (Shanghai) Co., Ltd. Test Report

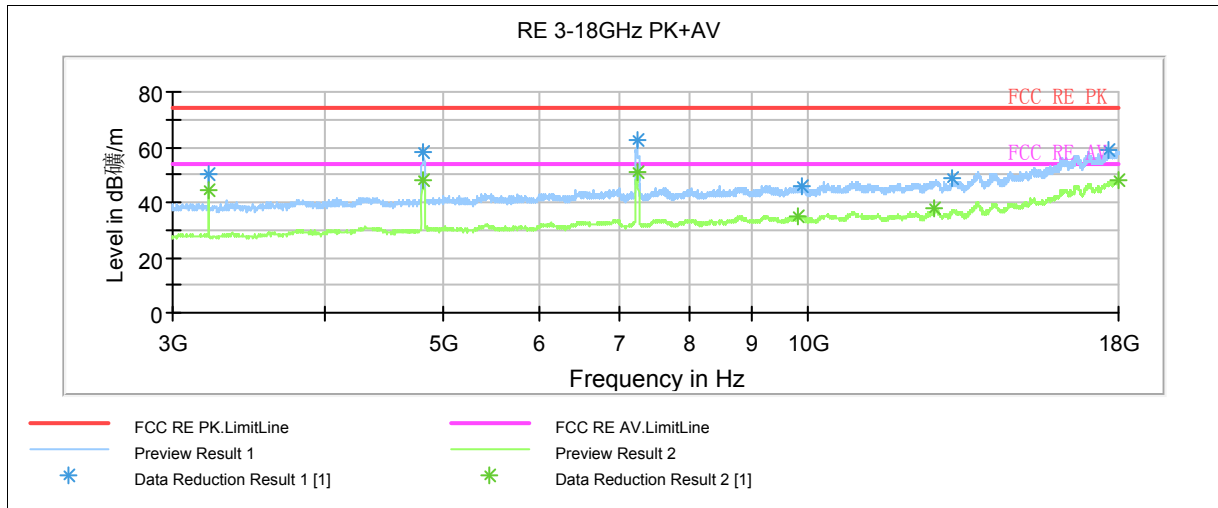

Note: This graph displays the maximum values of horizontal and vertical by software

Note: a font ( Level in dB $\mu$ V/m ) in the test plot =(level in dBuV/m)

Radiates Emission from 3GHz to 18GHz

Frequency (MHz)	Peak (dBuV/m)	Height (cm)	Polarization	Azimuth (deg)	Reading value (dBuV/m)	Correct Factor (dB)	Margin (dB)	Limit (dBuV/m)
3215.625000	50.0	100.0	V	0.0	52.7	-2.7	24.0	74
4824.375000	58.1	100.0	V	352.0	60.0	-1.9	15.9	74
7237.500000	62.7	100.0	V	53.0	68.8	-6.1	11.3	74
9896.250000	46.1	100.0	H	0.0	55.9	-9.8	27.9	74
13141.875000	48.7	100.0	V	0.0	61.5	-12.8	25.3	74
17679.375000	59.2	100.0	H	273.0	82.0	-22.8	14.8	74

**Remark: 1. Correction Factor = Antenna factor+ Insertion loss (cable loss + amplifier gain)**

Frequency (MHz)	Average (dBuV/m)	Height (cm)	Polarization	Azimuth (deg)	Reading value (dBuV/m)	Correct Factor (dB)	Margin (dB)	Limit (dBuV/m)
3215.625000	44.1	100.0	V	0.0	46.8	-2.7	9.9	54
4822.500000	48.1	100.0	V	0.0	50.0	-1.9	5.9	54
7233.750000	50.7	100.0	V	43.0	56.8	-6.1	3.3	54
9817.500000	35.2	100.0	V	43.0	45.0	-9.8	18.8	54
12716.250000	37.5	100.0	V	127.0	50.3	-12.8	16.5	54
17996.250000	48.0	100.0	V	280.0	70.8	-22.8	6.0	54

**Remark: 1. Correction Factor = Antenna factor+ Insertion loss (cable loss + amplifier gain)**



# TA Technology (Shanghai) Co., Ltd. Test Report

Report No.: RXA1409-0216RF01R1

Page 65of 96

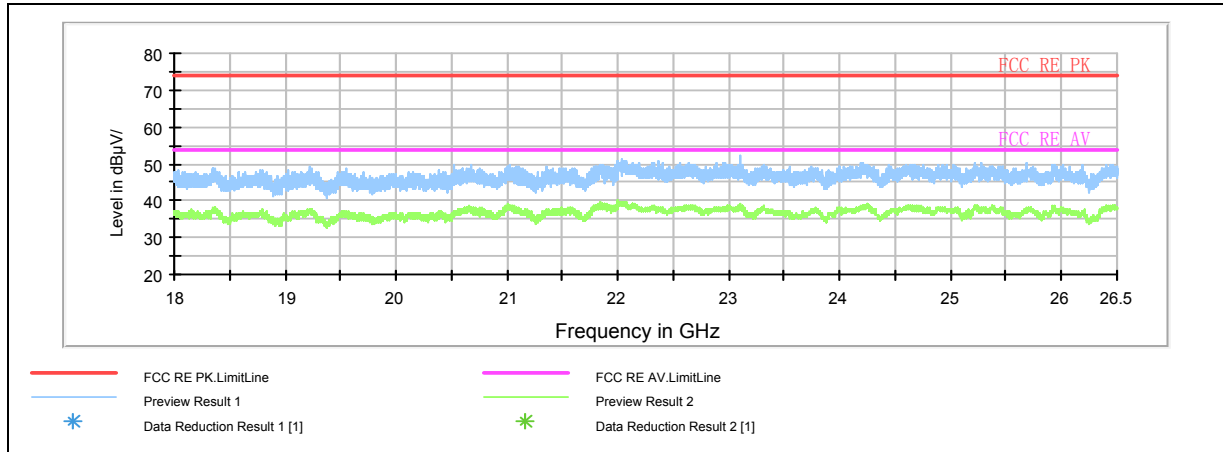

Note: This graph displays the maximum values of horizontal and vertical by software

Note: a font ( Level in dBuV/m ) in the test plot =(level in dBuV/m)

Radiates Emission from 18GHz to 26.5GHz

# TA Technology (Shanghai) Co., Ltd. Test Report

## 802.11g CH6

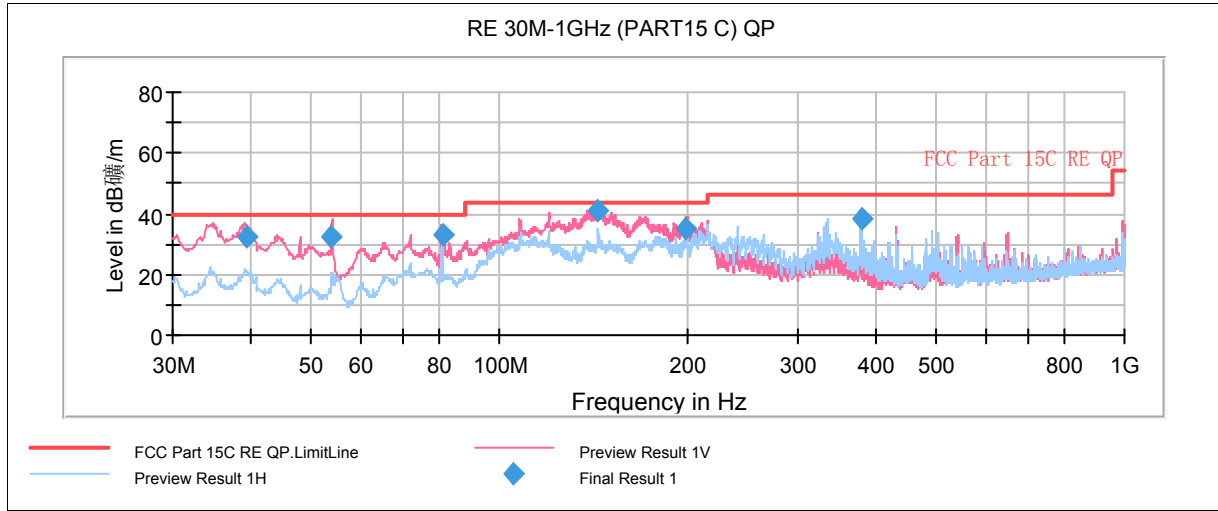

Note: This graph displays the maximum values of horizontal and vertical by software

Note: a font ( Level in dB $\mu$ V/m ) in the test plot =(level in dBuV/m)

Radiates Emission from 30MHz to 1GHz

Frequency (MHz)	Quasi-Peak (dBuV/m)	Height (cm)	Polarization	Azimuth (deg)	Reading value (dBuV/m)	Correct Factor (dB)	Margin (dB)	Limit (dBuV/m)
39.353750	32.1	100.0	V	26.0	51.4	-19.3	7.9	40.0
53.947500	32.2	100.0	V	89.0	54.6	-22.4	7.8	40.0
81.143750	33.1	125.0	V	188.0	61.0	-27.9	6.9	40.0
143.995000	41.0	100.0	V	330.0	70.2	-29.2	2.5	43.5
199.208750	35.3	100.0	V	136.0	61.7	-26.4	8.2	43.5
378.816250	38.4	100.0	H	248.0	59.3	-20.9	7.6	46.0

**Remark: 1. Quasi-Peak = Reading value + Correction factor**

**2. Correction Factor = Antenna factor+ Insertion loss(cable loss+amplifier gain)**

**3. Margin = Limit – Quasi-Peak**

# TA Technology (Shanghai) Co., Ltd. Test Report

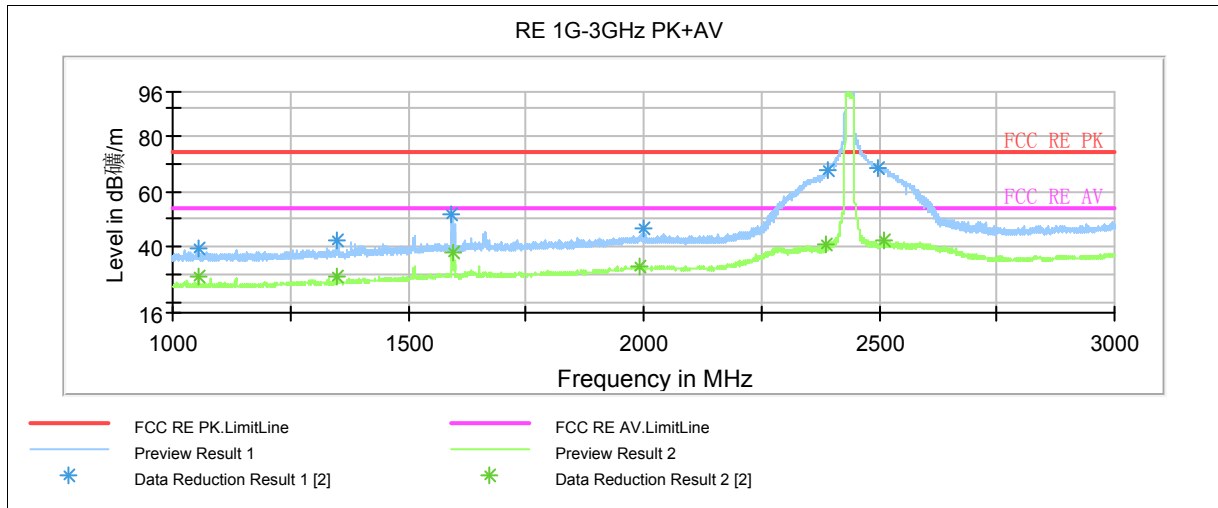

Note: This graph displays the maximum values of horizontal and vertical by software

Note: a font ( Level in dBμV/m ) in the test plot =(level in dBuV/m)

Note: The signal beyond the limit is carrier.

Radiates Emission from 1GHz to 3GHz

Frequency (MHz)	Peak (dBuV/m)	Height (cm)	Polarization	Azimuth (deg)	Reading value (dBuV/m)	Correct Factor (dB)	Margin (dB)	Limit (dBuV/m)
1055.750000	36.8	101.0	V	21.0	46.7	-9.9	37.2	74
1350.000000	42.4	101.0	V	352.0	51.3	-8.9	31.6	74
1595.750000	51.4	101.0	V	21.0	58.1	-6.7	22.6	74
1990.500000	42.4	101.0	V	161.0	45.4	-3.0	31.6	74
2388.750000	67.1	101.0	V	30.0	69.3	-2.2	6.9	74
2509.500000	67.3	101.0	V	344.0	68.2	-0.9	6.7	74

Remark: 1. Correction Factor = Antenna factor+ Insertion loss (cable loss + amplifier gain)

Frequency (MHz)	Average (dBuV/m)	Height (cm)	Polarization	Azimuth (deg)	Reading value (dBuV/m)	Correct Factor (dB)	Margin (dB)	Limit (dBuV/m)
1055.750000	29.0	101.0	V	21.0	38.9	-9.9	25.0	54
1350.000000	29.3	101.0	V	352.0	38.2	-8.9	24.7	54
1595.750000	38.0	101.0	V	21.0	44.7	-6.7	16.0	54
1990.500000	33.0	101.0	V	161.0	36.0	-3.0	21.0	54
2388.750000	40.6	101.0	V	30.0	42.8	-2.2	13.4	54
2509.500000	42.2	101.0	V	344.0	43.1	-0.9	11.8	54

Remark: 1. Correction Factor = Antenna factor+ Insertion loss (cable loss + amplifier gain)

# TA Technology (Shanghai) Co., Ltd. Test Report

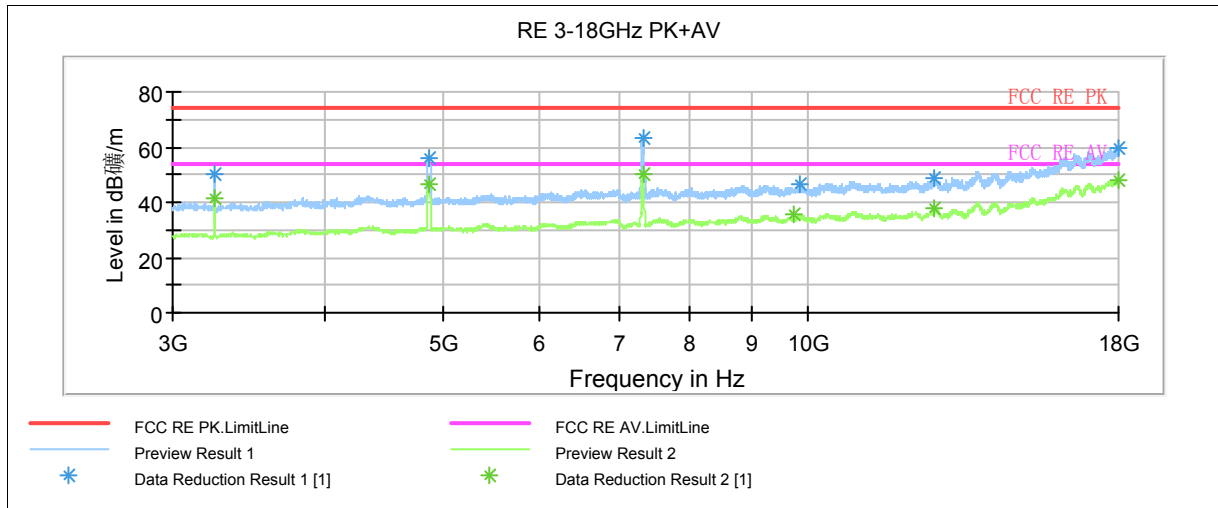

Note: This graph displays the maximum values of horizontal and vertical by software

Note: a font ( Level in dB $\mu$ V/m ) in the test plot =(level in dBuV/m)

Radiates Emission from 3GHz to 18GHz

Frequency (MHz)	Peak (dBuV/m)	Height (cm)	Polarization	Azimuth (deg)	Reading value (dBuV/m)	Correct Factor (dB)	Margin (dB)	Limit (dBuV/m)
3247.500000	50.4	100.0	V	0.0	52.7	-2.3	23.6	74
4876.875000	55.9	100.0	V	351.0	57.8	-1.9	18.1	74
7314.375000	63.6	100.0	V	50.0	69.3	-5.7	10.4	74
9860.625000	46.4	100.0	V	196.0	56.3	-9.9	27.6	74
12690.000000	48.6	100.0	H	228.0	60.6	-12.0	25.4	74
17983.125000	59.9	100.0	H	0.0	83.3	-23.4	14.1	74

Remark: 1. Correction Factor = Antenna factor+ Insertion loss (cable loss + amplifier gain)

Frequency (MHz)	Average (dBuV/m)	Height (cm)	Polarization	Azimuth (deg)	Reading value (dBuV/m)	Correct Factor (dB)	Margin (dB)	Limit (dBuV/m)
3247.500000	41.7	100.0	V	0.0	44.0	-2.3	12.3	54
4873.125000	46.5	100.0	V	351.0	48.4	-1.9	7.5	54
7316.250000	50.5	100.0	V	40.0	56.2	-5.7	3.5	54
9748.125000	35.4	100.0	H	0.0	45.3	-9.9	18.6	54
12708.750000	37.6	100.0	V	0.0	49.6	-12.0	16.4	54
17994.375000	48.0	100.0	V	50.0	71.4	-23.4	6.0	54

Remark: 1. Correction Factor = Antenna factor+ Insertion loss (cable loss + amplifier gain)

# TA Technology (Shanghai) Co., Ltd. Test Report

Report No.: RXA1409-0216RF01R1

Page 69of 96

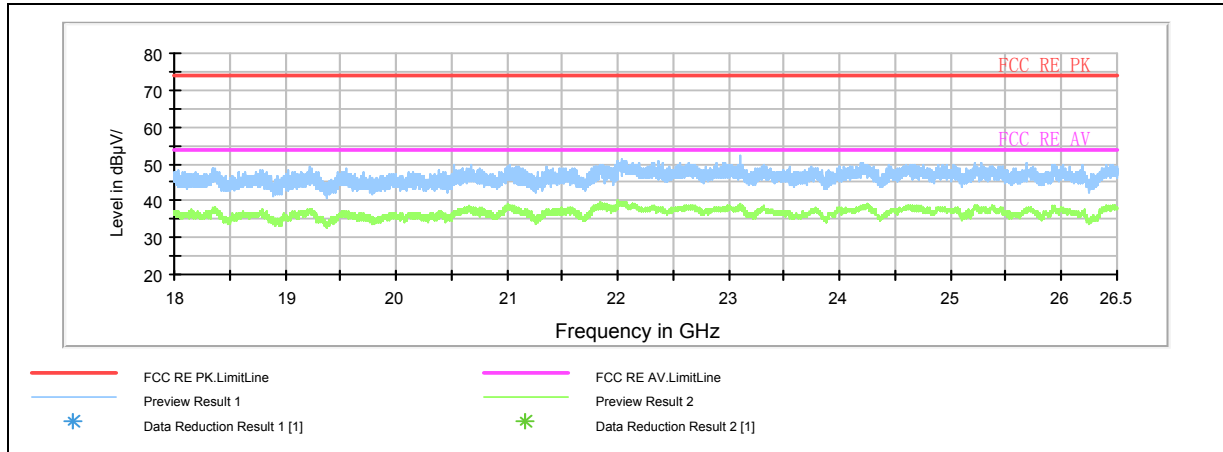

Note: This graph displays the maximum values of horizontal and vertical by software

Note: a font ( Level in dBuV/m )in the test plot =(level in dBuV/m)

Radiates Emission from 18GHz to 26.5GHz

# TA Technology (Shanghai) Co., Ltd. Test Report

## 802.11g CH11

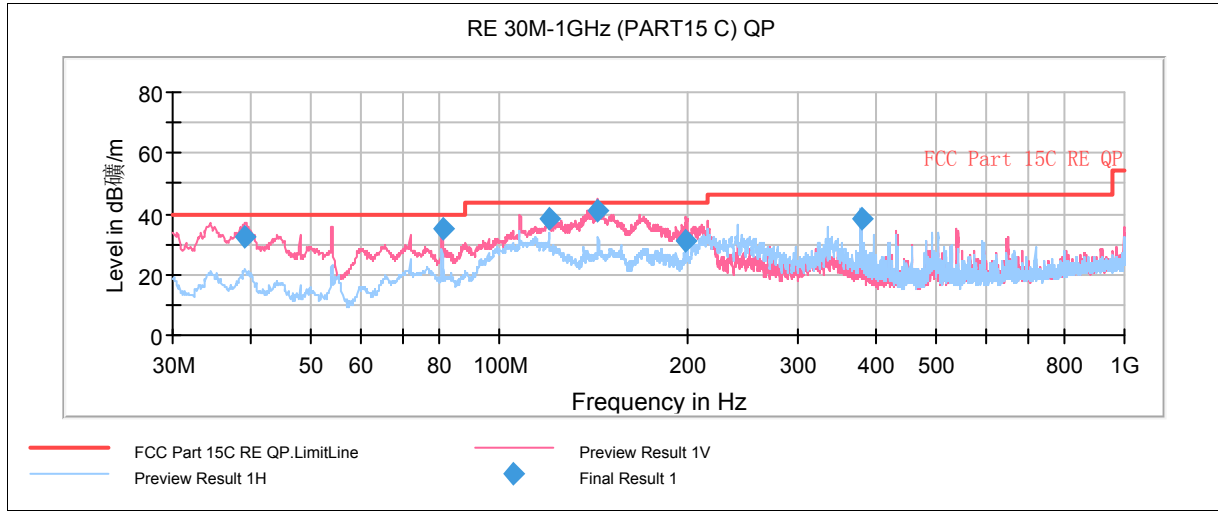

Note: This graph displays the maximum values of horizontal and vertical by software

Note: a font ( Level in dB $\mu$ V/m ) in the test plot =(level in dBuV/m)

Radiates Emission from 30MHz to 1GHz

Frequency (MHz)	Quasi-Peak (dBuV/m)	Height (cm)	Polarization	Azimuth (deg)	Reading value (dBuV/m)	Correct Factor (dB)	Margin (dB)	Limit (dBuV/m)
39.235000	32.4	100.0	V	0.0	51.7	-19.3	7.6	40.0
81.147500	35.3	125.0	V	0.0	63.2	-27.9	4.7	40.0
119.987500	38.5	100.0	V	347.0	65.8	-27.3	5.0	43.5
143.995000	40.9	100.0	V	336.0	70.1	-29.2	2.6	43.5
199.203750	30.8	100.0	V	165.0	57.2	-26.4	12.7	43.5
378.816250	38.5	100.0	H	250.0	59.4	-20.9	7.5	46.0

Remark: 1. Quasi-Peak = Reading value + Correction factor

2. Correction Factor = Antenna factor+ Insertion loss(cable loss+amplifier gain)

3. Margin = Limit – Quasi-Peak

# TA Technology (Shanghai) Co., Ltd. Test Report

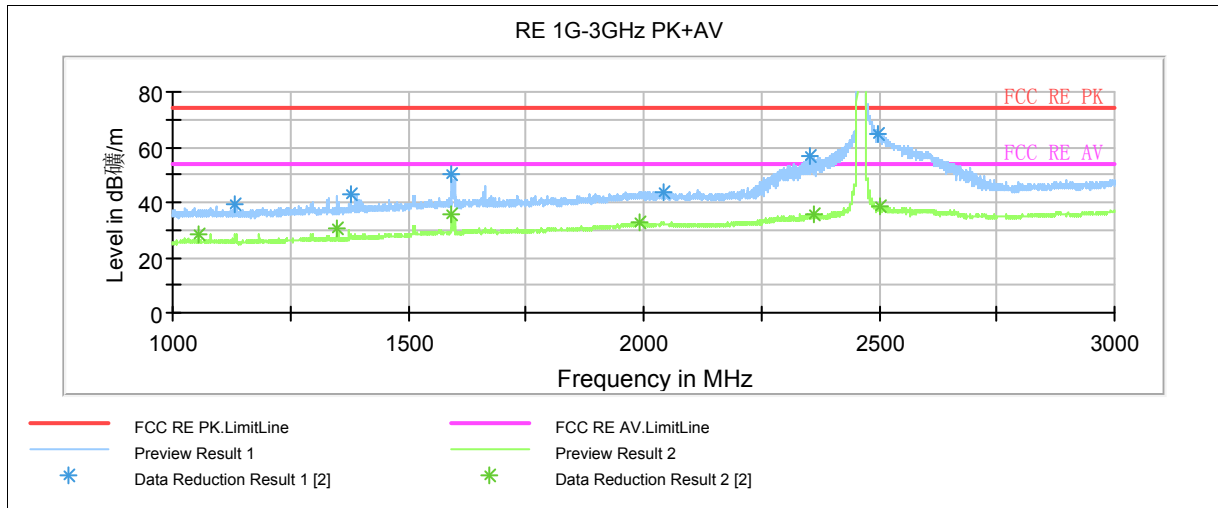

Note: This graph displays the maximum values of horizontal and vertical by software

Note: a font ( Level in dB $\mu$ V/m ) in the test plot =(level in dBuV/m)

Note: The signal beyond the limit is carrier.

Radiates Emission from 1GHz to 3GHz

Frequency (MHz)	Peak (dBuV/m)	Height (cm)	Polarization	Azimuth (deg)	Reading value (dBuV/m)	Correct Factor (dB)	Margin (dB)	Limit (dBuV/m)
1056.000000	37.1	101.0	V	27.0	47.0	-9.9	36.9	74
1350.250000	41.8	101.0	V	37.0	50.7	-8.9	32.2	74
1593.250000	49.6	101.0	V	27.0	56.3	-6.7	24.4	74
1992.250000	43.5	101.0	V	102.0	46.5	-3.0	30.5	74
2363.000000	55.1	101.0	V	45.0	57.4	-2.3	18.9	74
2502.500000	64.7	101.0	V	37.0	65.6	-0.9	9.3	74

Remark: 1. Correction Factor = Antenna factor+ Insertion loss (cable loss + amplifier gain)

Frequency (MHz)	Average (dBuV/m)	Height (cm)	Polarization	Azimuth (deg)	Reading value (dBuV/m)	Correct Factor (dB)	Margin (dB)	Limit (dBuV/m)
1056.000000	28.6	101.0	V	27.0	38.5	-9.9	25.4	54
1350.250000	30.2	101.0	V	37.0	39.1	-8.9	23.8	54
1593.250000	35.7	101.0	V	27.0	42.4	-6.7	18.3	54
1992.250000	32.7	101.0	V	102.0	35.7	-3.0	21.3	54
2363.000000	35.9	101.0	V	45.0	38.2	-2.3	18.1	54
2502.500000	38.5	101.0	V	37.0	39.4	-0.9	15.5	54

Remark: 1. Correction Factor = Antenna factor+ Insertion loss (cable loss + amplifier gain)

# TA Technology (Shanghai) Co., Ltd. Test Report

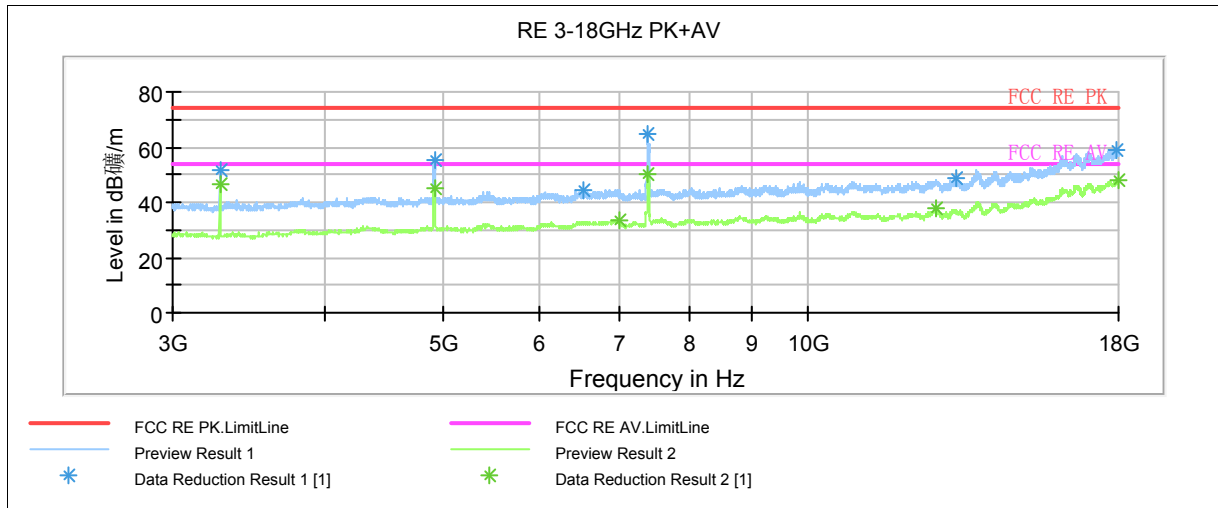

Note: This graph displays the maximum values of horizontal and vertical by software

Note: a font ( Level in dBμV/m ) in the test plot =(level in dBuV/m)

Radiates Emission from 3GHz to 18GHz

Frequency (MHz)	Peak (dBuV/m)	Height (cm)	Polarization	Azimuth (deg)	Reading value (dBuV/m)	Correct Factor (dB)	Margin (dB)	Limit (dBuV/m)
3281.250000	51.6	100.0	V	0.0	53.9	-2.3	22.4	74
4927.500000	55.1	100.0	V	352.0	57.0	-1.9	18.9	74
6526.875000	44.3	100.0	V	0.0	48.8	-4.5	29.7	74
7380.000000	64.4	100.0	V	30.0	70.1	-5.7	9.6	74
13239.375000	48.7	100.0	H	93.0	61.4	-12.7	25.3	74
17934.375000	59.0	100.0	H	229.0	82.4	-23.4	15.0	74

**Remark: 1. Correction Factor = Antenna factor+ Insertion loss (cable loss + amplifier gain)**

Frequency (MHz)	Average (dBuV/m)	Height (cm)	Polarization	Azimuth (deg)	Reading value (dBuV/m)	Correct Factor (dB)	Margin (dB)	Limit (dBuV/m)
3281.250000	46.2	100.0	V	0.0	48.5	-2.3	7.8	54
4923.750000	45.3	100.0	V	352.0	47.2	-1.9	8.7	54
6984.375000	33.8	100.0	H	75.0	38.7	-4.9	20.2	54
7389.375000	49.8	100.0	V	30.0	55.5	-5.7	4.2	54
12755.625000	37.6	100.0	V	0.0	50.2	-12.6	16.4	54
17992.500000	48.0	100.0	V	281.0	71.5	-23.5	6.0	54

**Remark: 1. Correction Factor = Antenna factor+ Insertion loss (cable loss + amplifier gain)**



# TA Technology (Shanghai) Co., Ltd. Test Report

Report No.: RXA1409-0216RF01R1

Page 73of 96

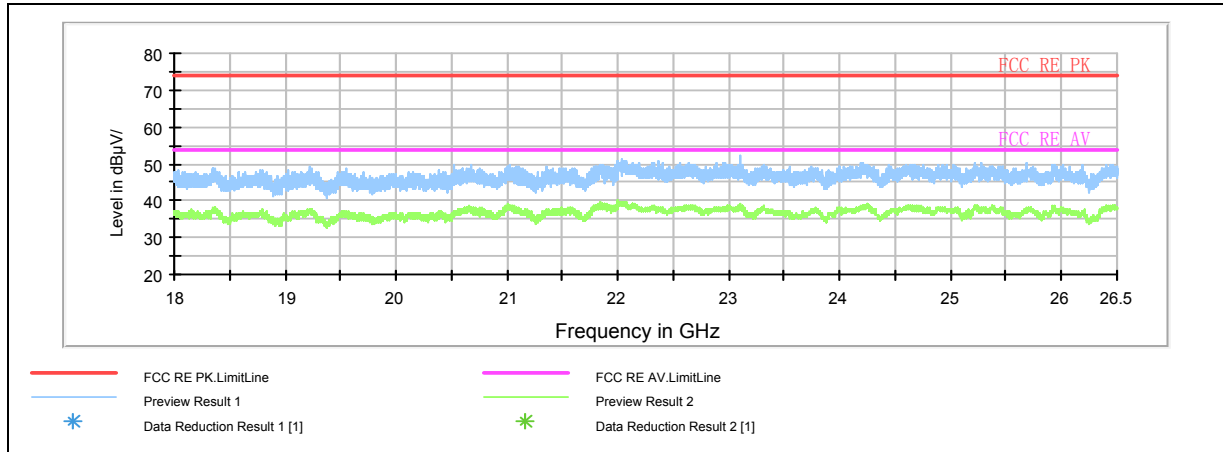

Note: This graph displays the maximum values of horizontal and vertical by software

Note: a font ( Level in dBuV/m )in the test plot =(level in dBuV/m)

Radiates Emission from 18GHz to 26.5GHz

# TA Technology (Shanghai) Co., Ltd. Test Report

## 802.11n(HT20) CH1

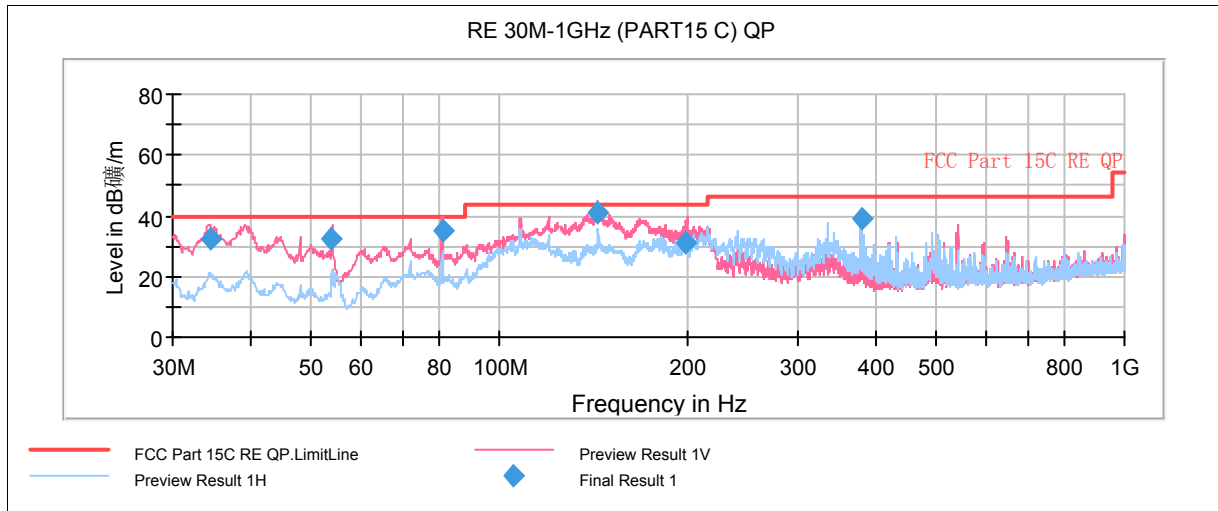

Note: This graph displays the maximum values of horizontal and vertical by software

Note: a font ( Level in dB $\mu$ V/m ) in the test plot =(level in dBuV/m)

Radiates Emission from 30MHz to 1GHz

Frequency (MHz)	Quasi-Peak (dBuV/m)	Height (cm)	Polarization	Azimuth (deg)	Reading value (dBuV/m)	Correct Factor (dB)	Margin (dB)	Limit (dBuV/m)
34.506250	32.7	100.0	V	339.0	51.7	-19.0	7.3	40.0
53.947500	32.5	100.0	V	81.0	54.9	-22.4	7.5	40.0
81.145000	35.3	125.0	V	352.0	63.2	-27.9	4.7	40.0
143.995000	41.0	100.0	V	339.0	70.2	-29.2	2.5	43.5
199.210000	30.9	100.0	V	341.0	57.3	-26.4	12.6	43.5
378.816250	38.7	100.0	H	248.0	59.6	-20.9	7.3	46.0

**Remark: 1. Quasi-Peak = Reading value + Correction factor**

**2. Correction Factor = Antenna factor+ Insertion loss(cable loss+amplifier gain)**

**3. Margin = Limit – Quasi-Peak**

# TA Technology (Shanghai) Co., Ltd. Test Report

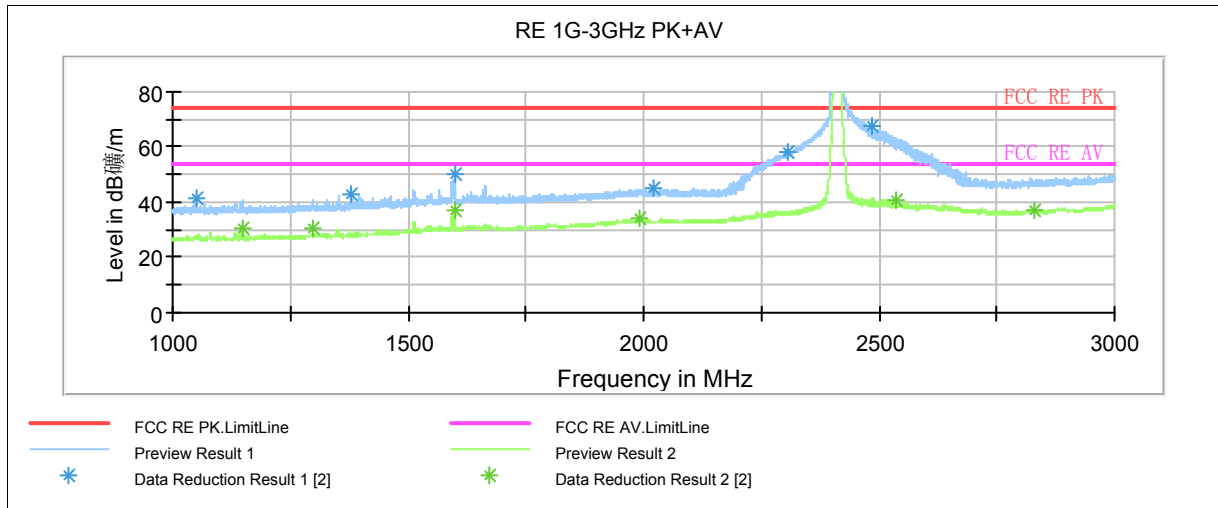

Note: This graph displays the maximum values of horizontal and vertical by software

Note: a font ( Level in dB $\mu$ V/m ) in the test plot =(level in dBuV/m)

Note: The signal beyond the limit is carrier.

Radiates Emission from 1GHz to 3GHz

Frequency (MHz)	Peak (dBuV/m)	Height (cm)	Polarization	Azimuth (deg)	Reading value (dBuV/m)	Correct Factor (dB)	Margin (dB)	Limit (dBuV/m)
1051.250000	41.7	100.0	V	322.0	51.6	-9.9	32.3	74
1379.500000	43.2	100.0	V	0.0	51.6	-8.4	30.8	74
1598.500000	50.1	100.0	V	322.0	56.8	-6.7	23.9	74
2020.000000	44.9	100.0	V	0.0	48.2	-3.3	29.1	74
2304.500000	58.0	100.0	V	29.0	60.9	-2.9	16.0	74
2486.750000	67.3	100.0	V	38.0	67.9	-0.6	6.7	74

Remark: 1. Correction Factor = Antenna factor+ Insertion loss (cable loss + amplifier gain)

Frequency (MHz)	Average (dBuV/m)	Height (cm)	Polarization	Azimuth (deg)	Reading value (dBuV/m)	Correct Factor (dB)	Margin (dB)	Limit (dBuV/m)
1148.500000	30.3	100.0	V	314.0	40.1	-9.8	23.7	54
1298.000000	30.5	100.0	V	38.0	39.8	-9.3	23.5	54
1598.000000	36.8	100.0	V	306.0	43.5	-6.7	17.2	54
1991.250000	34.2	100.0	H	0.0	37.2	-3.0	19.8	54
2537.250000	40.9	100.0	V	29.0	41.9	-1.0	13.1	54
2830.750000	37.3	100.0	V	246.0	37.1	0.2	16.7	54

Remark: 1. Correction Factor = Antenna factor+ Insertion loss (cable loss + amplifier gain)

# TA Technology (Shanghai) Co., Ltd. Test Report

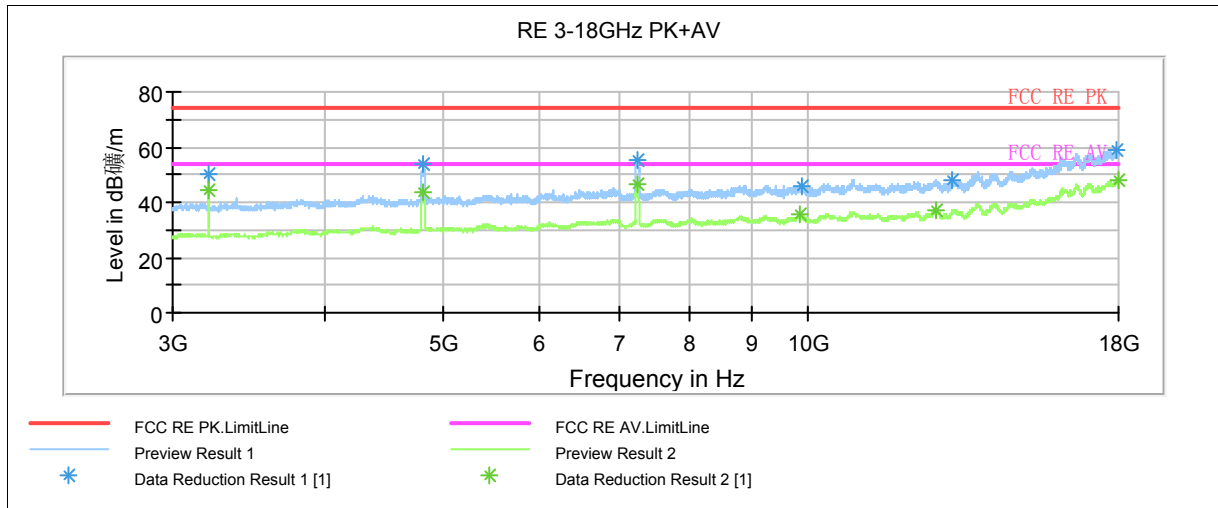

Note: This graph displays the maximum values of horizontal and vertical by software

Note: a font ( Level in dB $\mu$ V/m ) in the test plot =(level in dBuV/m)

Radiates Emission from 3GHz to 18GHz

Frequency (MHz)	Peak (dBuV/m)	Height (cm)	Polarization	Azimuth (deg)	Reading value (dBuV/m)	Correct Factor (dB)	Margin (dB)	Limit (dBuV/m)
3215.625000	50.1	100.0	V	0.0	52.8	-2.7	23.9	74
4830.000000	53.9	100.0	V	327.0	55.8	-1.9	20.1	74
7237.500000	55.4	100.0	V	48.0	61.5	-6.1	18.6	74
9896.250000	46.1	100.0	H	273.0	55.9	-9.8	27.9	74
13125.000000	48.0	100.0	H	84.0	60.8	-12.8	26.0	74
17943.750000	59.0	100.0	V	0.0	82.4	-23.4	15.0	74

**Remark: 1. Correction Factor = Antenna factor+ Insertion loss (cable loss + amplifier gain)**

Frequency (MHz)	Average (dBuV/m)	Height (cm)	Polarization	Azimuth (deg)	Reading value (dBuV/m)	Correct Factor (dB)	Margin (dB)	Limit (dBuV/m)
3215.625000	44.2	100.0	V	0.0	46.9	-2.7	9.8	54
4824.375000	43.3	100.0	V	353.0	45.2	-1.9	10.7	54
7239.375000	46.3	100.0	V	58.0	52.4	-6.1	7.7	54
9851.250000	35.6	100.0	H	102.0	45.4	-9.8	18.4	54
12735.000000	37.4	100.0	H	145.0	50.0	-12.6	16.6	54
17986.875000	47.9	100.0	H	153.0	71.4	-23.5	6.1	54

**Remark: 1. Correction Factor = Antenna factor+ Insertion loss (cable loss + amplifier gain)**

# TA Technology (Shanghai) Co., Ltd. Test Report

Report No.: RXA1409-0216RF01R1

Page 77 of 96

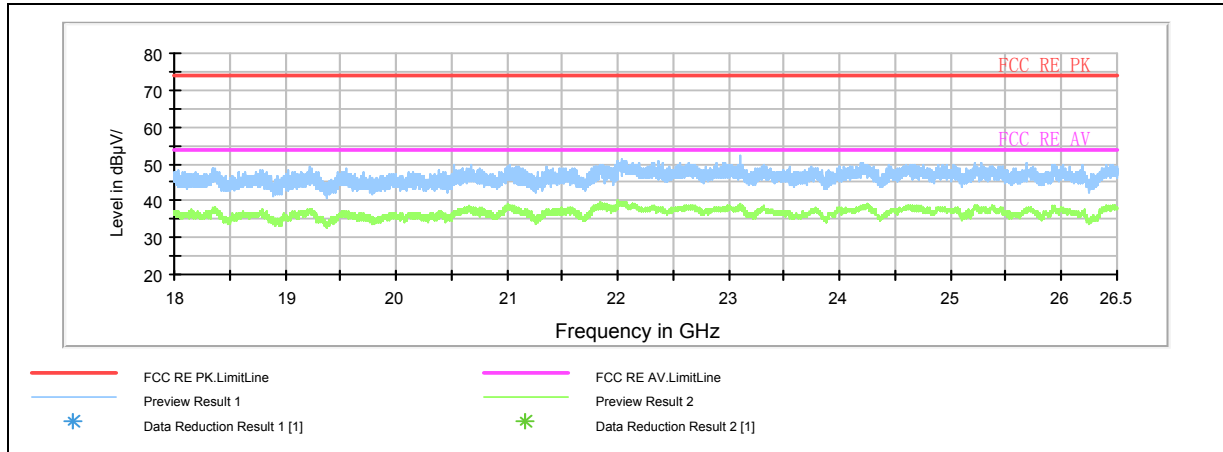

Note: This graph displays the maximum values of horizontal and vertical by software

Note: a font ( Level in dBuV/m ) in the test plot =(level in dBuV/m)

Radiates Emission from 18GHz to 26.5GHz

# TA Technology (Shanghai) Co., Ltd. Test Report

Report No.: RXA1409-0216RF01R1

Page 78of 96

## 802.11n(HT20) CH6

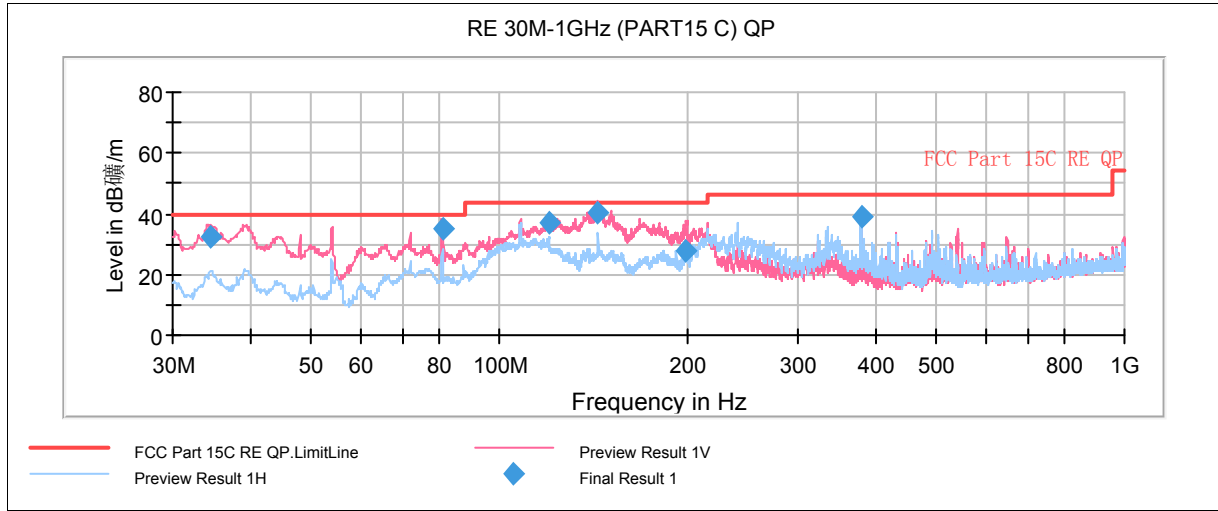

Note: This graph displays the maximum values of horizontal and vertical by software

Note: a font ( Level in dB $\mu$ V/m ) in the test plot =(level in dBuV/m)

Radiates Emission from 30MHz to 1GHz

Frequency (MHz)	Quasi-Peak (dBuV/m)	Height (cm)	Polarization	Azimuth (deg)	Reading value (dBuV/m)	Correct Factor (dB)	Margin (dB)	Limit (dBuV/m)
34.507500	32.1	100.0	V	311.0	51.1	-19.0	7.9	40.0
81.145000	34.8	125.0	V	7.0	62.7	-27.9	5.2	40.0
119.987500	37.1	100.0	V	122.0	64.4	-27.3	6.4	43.5
143.995000	40.0	100.0	V	331.0	69.2	-29.2	3.5	43.5
199.205000	27.6	100.0	V	17.0	54.0	-26.4	15.9	43.5
378.816250	38.9	100.0	H	251.0	59.8	-20.9	7.1	46.0

Remark: 1. Quasi-Peak = Reading value + Correction factor

2. Correction Factor = Antenna factor+ Insertion loss(cable loss+amplifier gain)

3. Margin = Limit – Quasi-Peak

# TA Technology (Shanghai) Co., Ltd. Test Report

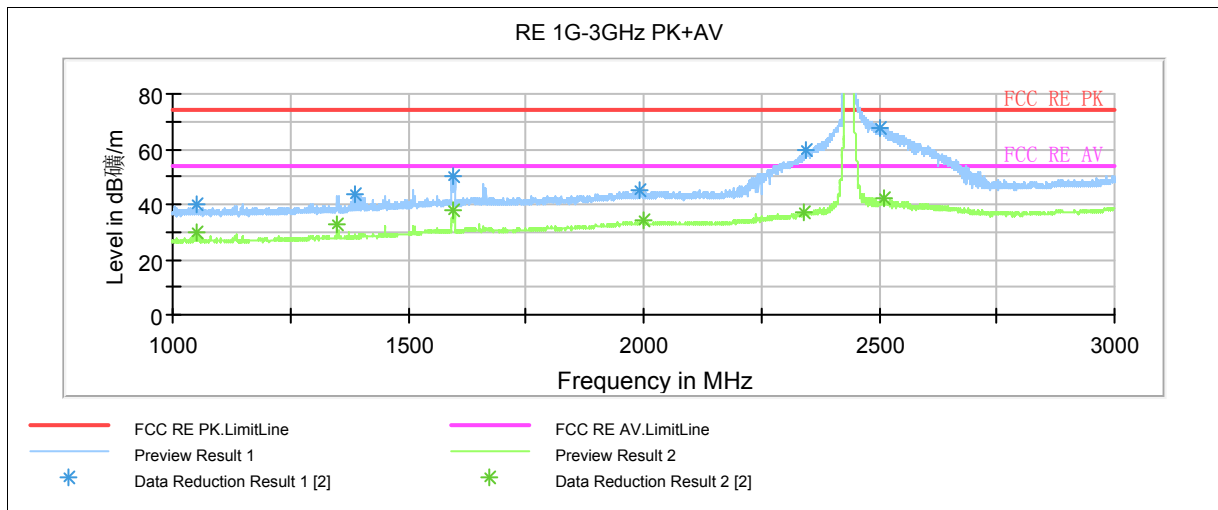

Note: This graph displays the maximum values of horizontal and vertical by software

Note: a font ( Level in dB $\mu$ V/m ) in the test plot =(level in dBuV/m)

Note: The signal beyond the limit is carrier.

Radiates Emission from 1GHz to 3GHz

Frequency (MHz)	Peak (dBuV/m)	Height (cm)	Polarization	Azimuth (deg)	Reading value (dBuV/m)	Correct Factor (dB)	Margin (dB)	Limit (dBuV/m)
1050.750000	40.3	100.0	H	273.0	50.2	-9.9	33.7	74
1386.250000	43.4	100.0	V	327.0	51.7	-8.3	30.6	74
1594.500000	50.1	100.0	V	319.0	56.8	-6.7	23.9	74
1992.500000	44.8	100.0	V	341.0	47.8	-3.0	29.2	74
2342.750000	59.4	100.0	V	38.0	61.5	-2.1	14.6	74
2503.250000	67.9	100.0	V	38.0	68.8	-0.9	6.1	74

**Remark: 1. Correction Factor = Antenna factor+ Insertion loss (cable loss + amplifier gain)**

Frequency (MHz)	Average (dBuV/m)	Height (cm)	Polarization	Azimuth (deg)	Reading value (dBuV/m)	Correct Factor (dB)	Margin (dB)	Limit (dBuV/m)
1050.500000	29.5	100.0	H	273.0	39.4	-9.9	24.5	54
1350.250000	33.0	100.0	V	28.0	41.9	-8.9	21.0	54
1596.000000	37.9	100.0	V	319.0	44.6	-6.7	16.1	54
1998.250000	33.8	100.0	H	1.0	36.8	-3.0	20.2	54
2342.250000	37.1	100.0	V	38.0	39.2	-2.1	16.9	54
2512.500000	42.4	100.0	V	28.0	43.3	-0.9	11.6	54

**Remark: 1. Correction Factor = Antenna factor+ Insertion loss (cable loss + amplifier gain)**

# TA Technology (Shanghai) Co., Ltd. Test Report

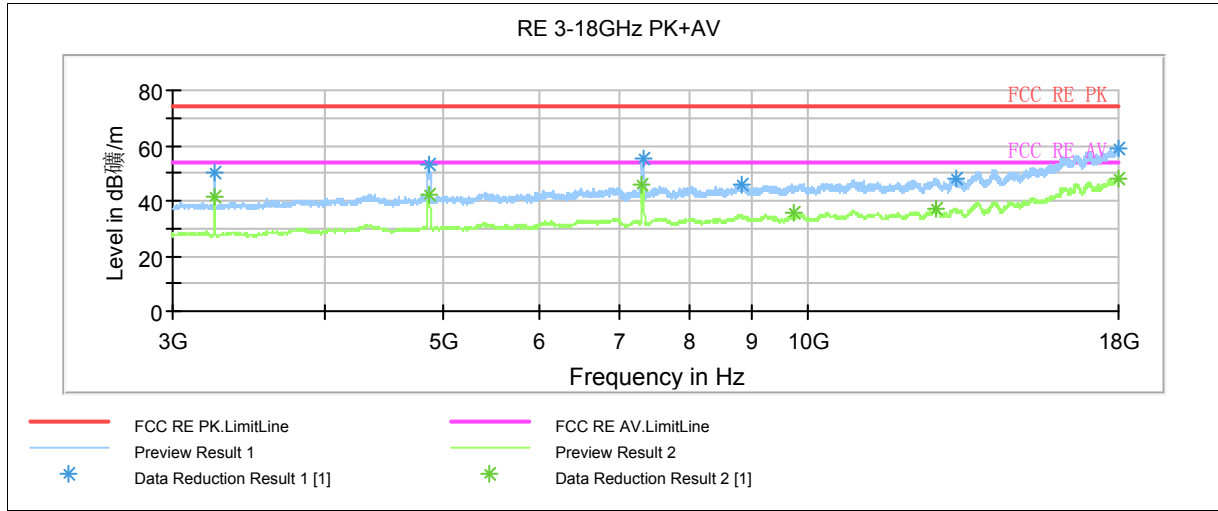

Note: This graph displays the maximum values of horizontal and vertical by software

Note: a font ( Level in dB $\mu$ V/m ) in the test plot =(level in dBuV/m)

Radiates Emission from 3GHz to 18GHz

Frequency (MHz)	Peak (dBuV/m)	Height (cm)	Polarization	Azimuth (deg)	Reading value (dBuV/m)	Correct Factor (dB)	Margin (dB)	Limit (dBuV/m)
3249.375000	50.3	100.0	V	0.0	52.7	-2.4	23.7	74
4869.375000	52.8	100.0	V	346.0	54.8	-2.0	21.2	74
7316.250000	55.0	100.0	V	39.0	60.7	-5.7	19.0	74
8801.250000	45.9	100.0	V	207.0	54.0	-8.1	28.1	74
13256.250000	48.1	100.0	V	278.0	60.8	-12.7	25.9	74
17968.125000	59.1	100.0	H	92.0	82.5	-23.4	14.9	74

Remark: 1. Correction Factor = Antenna factor+ Insertion loss (cable loss + amplifier gain)

Frequency (MHz)	Average (dBuV/m)	Height (cm)	Polarization	Azimuth (deg)	Reading value (dBuV/m)	Correct Factor (dB)	Margin (dB)	Limit (dBuV/m)
3247.500000	41.8	100.0	V	8.0	44.2	-2.4	12.2	54
4873.125000	42.4	100.0	V	346.0	44.4	-2.0	11.6	54
7305.000000	45.5	100.0	V	39.0	51.2	-5.7	8.5	54
9748.125000	35.8	100.0	H	0.0	43.9	-8.1	18.2	54
12735.000000	37.3	100.0	V	152.0	50.0	-12.7	16.7	54
17971.875000	47.7	100.0	V	233.0	71.1	-23.4	6.3	54

Remark: 1. Correction Factor = Antenna factor+ Insertion loss (cable loss + amplifier gain)



# TA Technology (Shanghai) Co., Ltd. Test Report

Report No.: RXA1409-0216RF01R1

Page 81 of 96

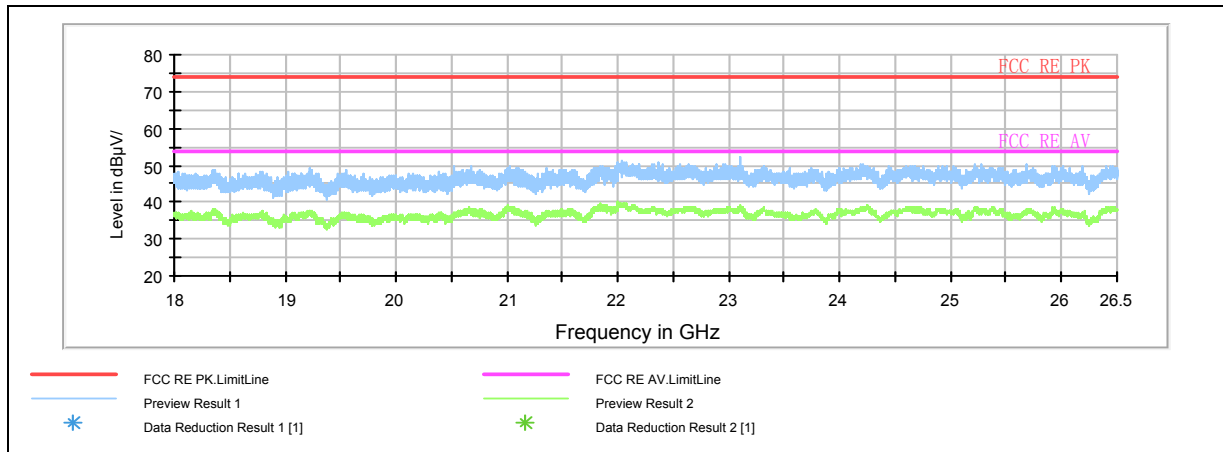

Note: This graph displays the maximum values of horizontal and vertical by software

Note: a font ( Level in dBµV/m ) in the test plot =(level in dBuv/m)

Radiates Emission from 18GHz to 26.5GHz

# TA Technology (Shanghai) Co., Ltd. Test Report

## 802.11n(HT20) CH11

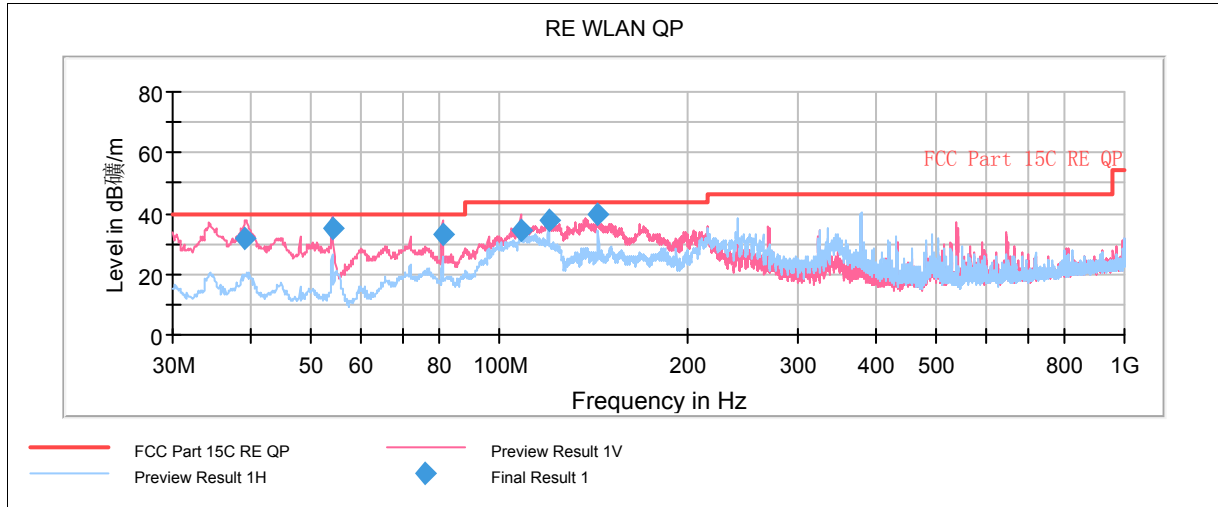

Note: This graph displays the maximum values of horizontal and vertical by software  
 Note: a font ( Level in dBμV/m ) in the test plot =(level in dBuV/m)  
 Radiates Emission from 30MHz to 1GHz

Frequency (MHz)	Quasi-Peak (dBuV/m)	Height (cm)	Polarization	Azimuth (deg)	Reading value (dBuV/m)	Correct Factor (dB)	Margin (dB)	Limit (dBuV/m)
39.255000	31.8	100.0	V	19.0	51.1	-19.3	8.2	40.0
53.967500	34.9	100.0	V	128.0	57.3	-22.4	5.1	40.0
81.126250	33.0	125.0	V	320.0	61.0	-28.0	7.0	40.0
108.205000	34.1	100.0	V	291.0	59.5	-25.4	9.4	43.5
120.008750	38.0	100.0	V	343.0	65.3	-27.3	5.5	43.5
143.975000	39.5	100.0	V	264.0	68.7	-29.2	4	43.5

- Remark: 1. Quasi-Peak = Reading value + Correction factor**  
**2. Correction Factor = Antenna factor+ Insertion loss(cable loss+amplifier gain)**  
**3. Margin = Limit – Quasi-Peak**

# TA Technology (Shanghai) Co., Ltd. Test Report

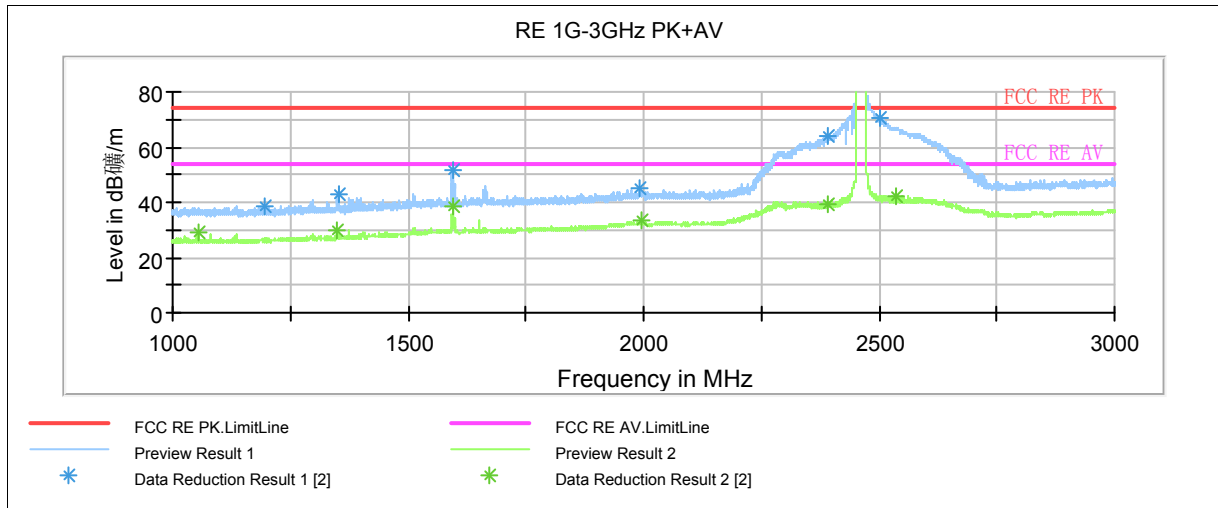

Note: This graph displays the maximum values of horizontal and vertical by software

Note: a font ( Level in dB $\mu$ V/m ) in the test plot =(level in dBuV/m)

Note: The signal beyond the limit is carrier.

Radiates Emission from 1GHz to 3GHz

Frequency (MHz)	Peak (dBuV/m)	Height (cm)	Polarization	Azimuth (deg)	Reading value (dBuV/m)	Correct Factor (dB)	Margin (dB)	Limit (dBuV/m)
1055.750000	36.9	101.0	V	28.0	46.8	-9.9	37.1	74
1349.250000	40.6	101.0	V	350.0	49.5	-8.9	33.4	74
1596.000000	51.5	101.0	V	28.0	58.2	-6.7	22.5	74
1993.750000	42.6	101.0	V	166.0	45.5	-2.9	31.4	74
2392.000000	61.9	101.0	V	0.0	64.1	-2.2	12.1	74
2538.000000	67.0	101.0	V	0.0	68.0	-1.0	7.0	74

Remark: 1. Correction Factor = Antenna factor+ Insertion loss (cable loss + amplifier gain)

Frequency (MHz)	Average (dBuV/m)	Height (cm)	Polarization	Azimuth (deg)	Reading value (dBuV/m)	Correct Factor (dB)	Margin (dB)	Limit (dBuV/m)
1055.750000	28.7	101.0	V	28.0	38.6	-9.9	25.3	54
1349.250000	30.0	101.0	V	350.0	38.9	-8.9	24.0	54
1596.000000	38.6	101.0	V	28.0	45.3	-6.7	15.4	54
1993.750000	33.4	101.0	V	166.0	36.3	-2.9	20.6	54
2392.000000	39.4	101.0	V	0.0	41.6	-2.2	14.6	54
2538.000000	42.3	101.0	V	0.0	43.3	-1.0	11.7	54

Remark: 1. Correction Factor = Antenna factor+ Insertion loss (cable loss + amplifier gain)

# TA Technology (Shanghai) Co., Ltd. Test Report

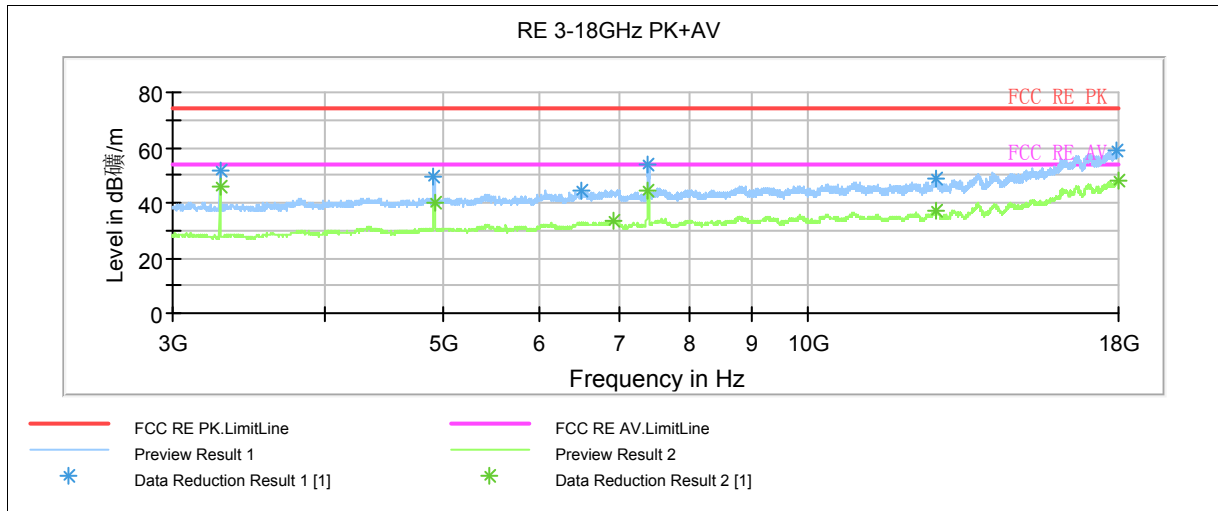

Note: This graph displays the maximum values of horizontal and vertical by software

Note: a font ( Level in dB $\mu$ V/m ) in the test plot =(level in dBuV/m)

Radiates Emission from 3GHz to 18GHz

Frequency (MHz)	Peak (dBuV/m)	Height (cm)	Polarization	Azimuth (deg)	Reading value (dBuV/m)	Correct Factor (dB)	Margin (dB)	Limit (dBuV/m)
3281.250000	51.6	100.0	V	0.0	53.9	-2.3	22.4	74
4918.125000	49.7	100.0	V	354.0	51.6	-1.9	24.3	74
6519.375000	44.6	100.0	H	123.0	49.1	-4.5	29.4	74
7381.875000	54.0	100.0	V	39.0	59.7	-5.7	20.0	74
12750.000000	48.4	100.0	V	185.0	61.0	-12.6	25.6	74
17930.625000	59.1	100.0	H	69.0	82.5	-23.4	14.9	74

Remark: 1. Correction Factor = Antenna factor+ Insertion loss (cable loss + amplifier gain)

Frequency (MHz)	Average (dBuV/m)	Height (cm)	Polarization	Azimuth (deg)	Reading value (dBuV/m)	Correct Factor (dB)	Margin (dB)	Limit (dBuV/m)
3281.250000	46.1	100.0	V	0.0	48.4	-2.3	7.9	54
4925.625000	39.8	100.0	V	68.0	41.7	-1.9	14.2	54
6916.875000	33.7	100.0	V	114.0	38.2	-4.5	20.3	54
7389.375000	44.4	100.0	V	39.0	50.1	-5.7	9.6	54
12744.375000	37.2	100.0	V	58.0	49.8	-12.6	16.8	54
17970.000000	48.2	100.0	V	185.0	71.6	-23.4	5.8	54

Remark: 1. Correction Factor = Antenna factor+ Insertion loss (cable loss + amplifier gain)

# TA Technology (Shanghai) Co., Ltd. Test Report

Report No.: RXA1409-0216RF01R1

Page 85of 96

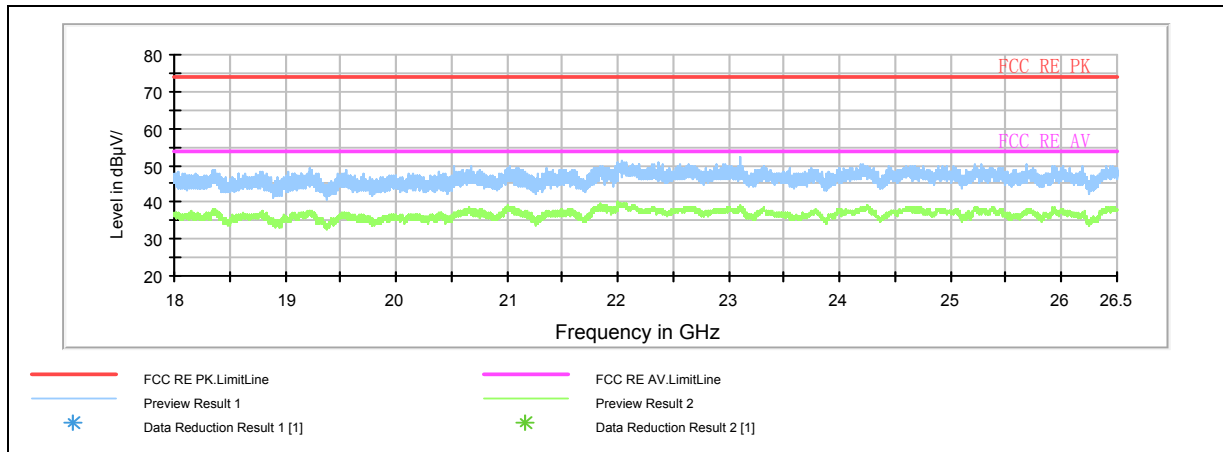

Note: This graph displays the maximum values of horizontal and vertical by software  
Note: a font ( Level in dBµV/m )in the test plot =(level in dBuv/m)  
Radiates Emission from 18GHz to 26.5GHz

## 2.10. Conducted Emissions

### Ambient condition

Temperature	Relative humidity	Pressure
23°C ~25°C	45%~50%	101.5kPa

### Method of Measurement

The EUT IS placed on a non-metallic table of 80cm height above the horizontal metal reference ground plane. During the test, the EUT was operating in its typical mode. The test method is according to ANSIC63.4-2009. Connect the AC power line of the EUT to the LISN Use EMI receiver to detect the average and Quasi-peak value. RBW is set to 9kHz, VBW is set to 30kHz The measurement result should include both L line and N line. The test is in transmitting mode.

### Test setup

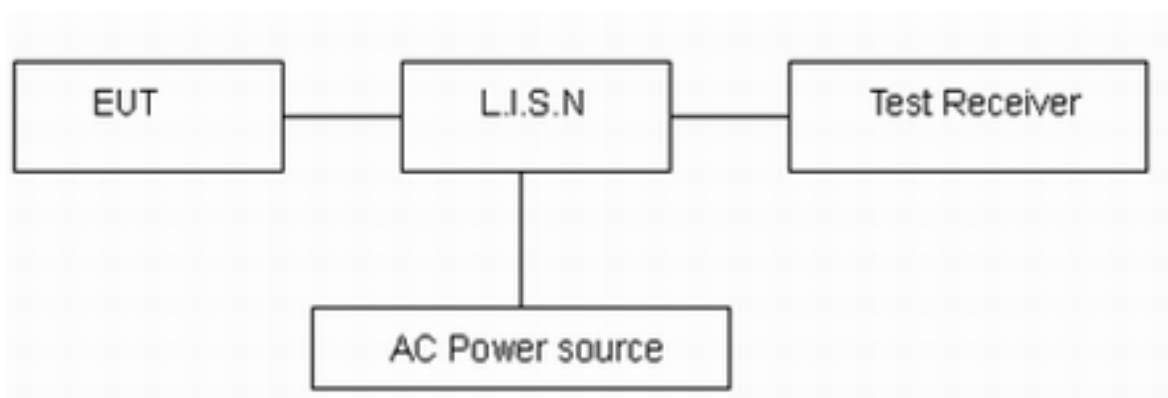

Note: AC Power source is used to change the voltage from 220V/50Hz to 110V/60Hz.

### Limits

Frequency (MHz)	Conducted Limits(dB $\mu$ V)	
	Quasi-peak	Average
0.15 - 0.5	66 to 56 *	56 to 46 *
0.5 - 5	56	46
5 - 30	60	50

\*: Decreases with the logarithm of the frequency.

### Measurement Uncertainty

The assessed measurement uncertainty to ensure 95% confidence level for the normal distribution is with the coverage factor  $k = 1.96$ ,  $U = 2.69$  dB.

# TA Technology (Shanghai) Co., Ltd. Test Report

Report No.: RXA1409-0216RF01R1

Page 87 of 96

## Test Results:

802.11b CH6

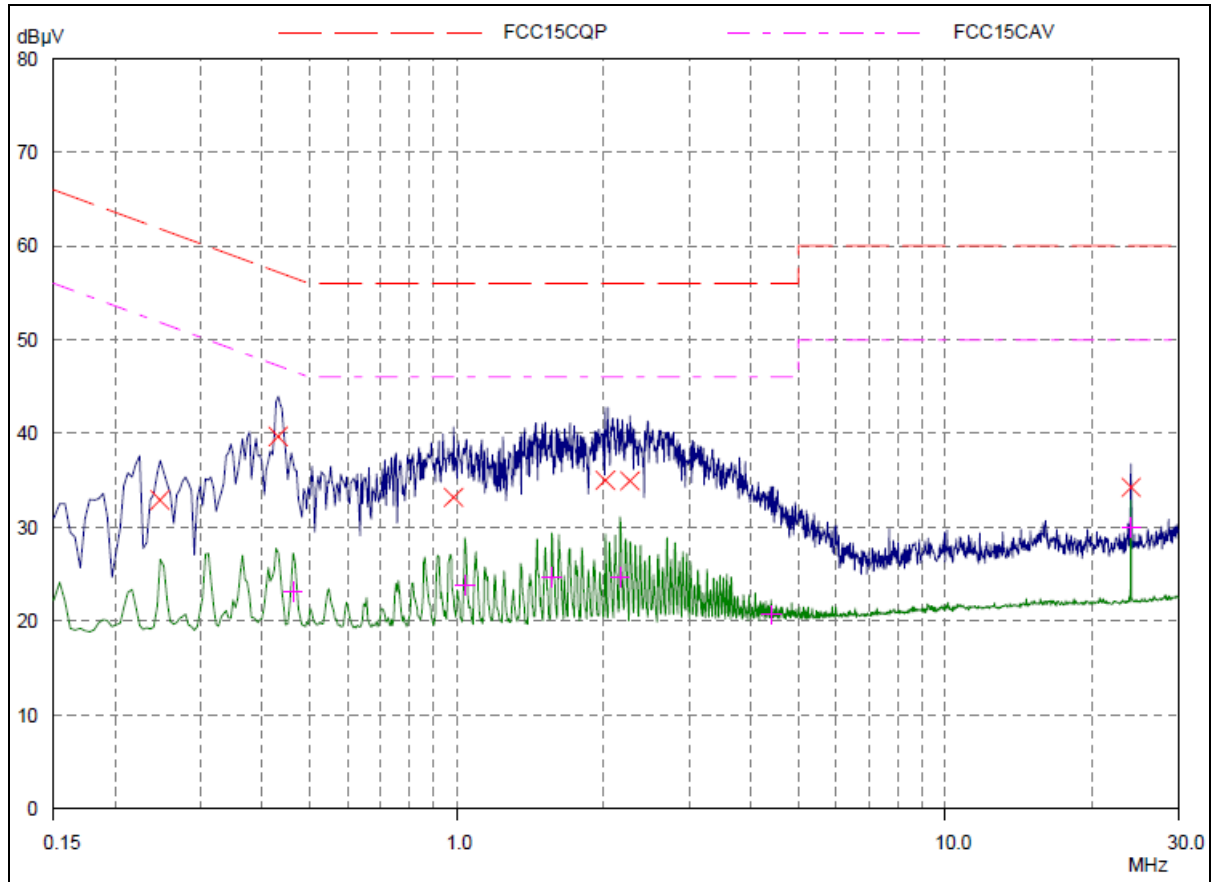

L Line

Final Measurement Results				
Frequency MHz	QP Level dBµV	QP Limit dBµV	QP Delta dB	Phase -
0.24765	32.91	61.84	28.93	L1
0.43125	39.68	57.23	17.55	L1
0.98593	33.19	56.00	22.81	L1
2.01718	35.01	56.00	20.99	L1
2.26718	34.95	56.00	21.05	L1
24.00156	34.28	60.00	25.72	L1
Frequency MHz	AV Level dBµV	AV Limit dBµV	AV Delta dB	Phase -
0.4625	23.15	46.65	23.50	L1
1.04062	23.87	46.00	22.13	L1
1.56796	24.64	46.00	21.36	L1
2.16171	24.69	46.00	21.31	L1
4.4	20.65	46.00	25.35	L1
23.99765	29.98	50.00	20.02	L1

# TA Technology (Shanghai) Co., Ltd. Test Report

Report No.: RXA1409-0216RF01R1

Page 88of 96

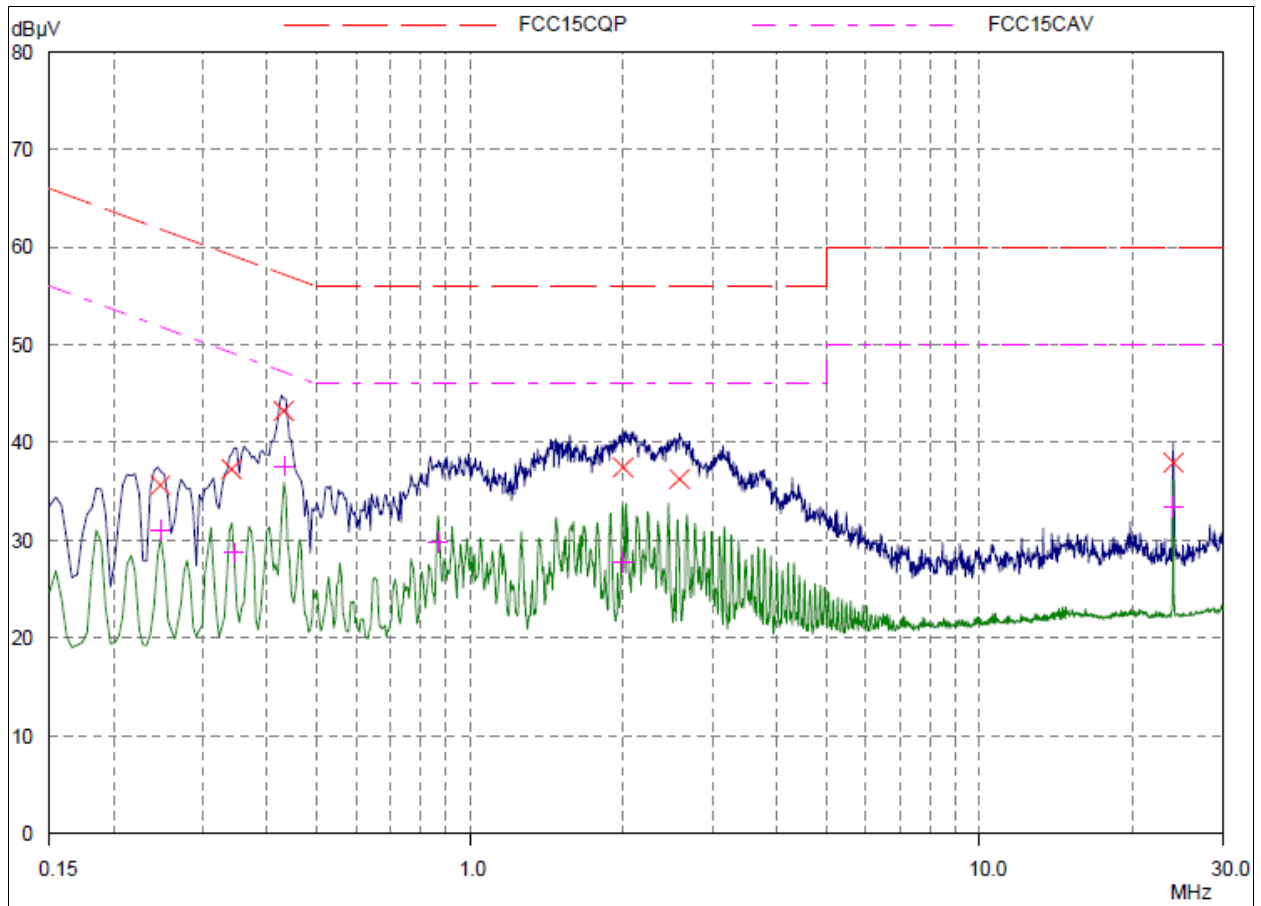

N Line

Final Measurement Results				
Frequency MHz	QP Level dBµV	QP Limit dBµV	QP Delta dB	Phase -
0.24765	35.65	61.84	26.19	N
0.3414	37.26	59.17	21.91	N
0.43125	43.24	57.23	13.99	N
1.99765	37.46	56.00	18.54	N
2.57578	36.28	56.00	19.72	N
24.00156	37.96	60.00	22.04	N
Frequency MHz	AV Level dBµV	AV Limit dBµV	AV Delta dB	Phase -
0.24765	30.97	51.84	20.87	N
0.34531	28.72	49.07	20.35	N
0.43125	37.57	47.23	9.66	N
0.86484	29.80	46.00	16.20	N
1.99765	27.73	46.00	18.27	N
24.00156	33.34	50.00	16.66	N



# TA Technology (Shanghai) Co., Ltd. Test Report

Report No.: RXA1409-0216RF01R1

Page 89of 96

802.11g CH6

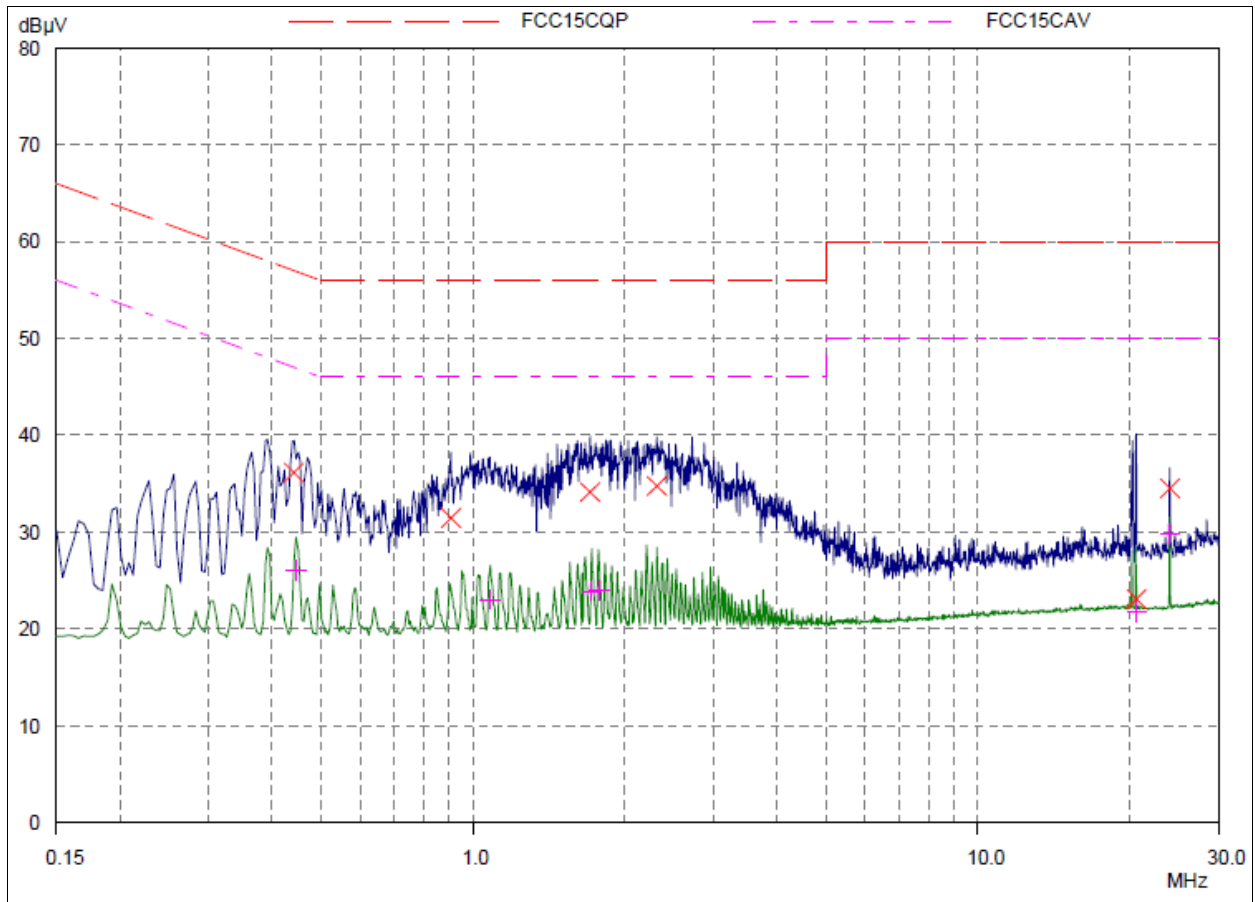

L Line

Final Measurement Results				
Frequency MHz	QP Level dBμV	QP Limit dBμV	QP Delta dB	Phase -
0.44296	36.15	57.01	20.86	L1
0.9039	31.47	56.00	24.53	L1
1.70468	34.15	56.00	21.85	L1
2.31406	34.76	56.00	21.24	L1
20.58359	23.10	60.00	36.90	L1
23.99765	34.50	60.00	25.50	L1
Frequency MHz	AV Level dBμV	AV Limit dBμV	AV Delta dB	Phase -
0.44687	26.07	46.93	20.86	L1
1.08359	23.01	46.00	22.99	L1
1.72031	23.90	46.00	22.10	L1
1.7789	23.96	46.00	22.04	L1
20.58359	21.81	50.00	28.19	L1
23.99765	29.79	50.00	20.21	L1

# TA Technology (Shanghai) Co., Ltd. Test Report

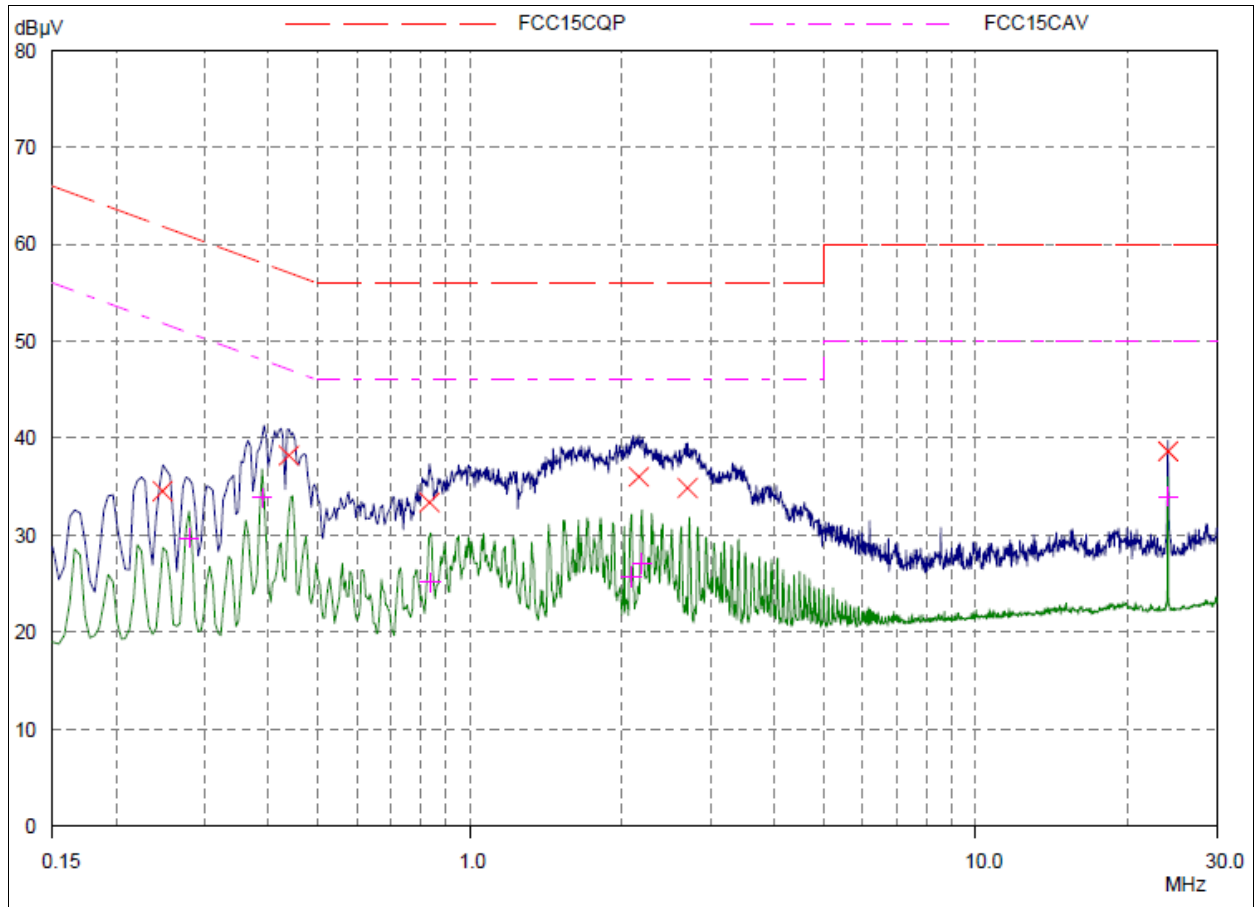

N Line

Final Measurement Results				
Frequency MHz	QP Level dBµV	QP Limit dBµV	QP Delta dB	Phase -
0.24765	34.55	61.84	27.29	N
0.43906	38.24	57.08	18.84	N
0.83359	33.36	56.00	22.64	N
2.16171	36.01	56.00	19.99	N
2.69296	34.86	56.00	21.14	N
23.99765	38.64	60.00	21.36	N
Frequency MHz	AV Level dBµV	AV Limit dBµV	AV Delta dB	Phase -
0.2789	29.73	50.85	21.12	N
0.38828	33.86	48.10	14.24	N
0.8375	25.18	46.00	20.82	N
2.0875	25.75	46.00	20.25	N
2.19296	27.11	46.00	18.89	N
23.99765	33.99	50.00	16.01	N

# TA Technology (Shanghai) Co., Ltd. Test Report

Report No.: RXA1409-0216RF01R1

Page 91 of 96

802.11n(HT20) CH6

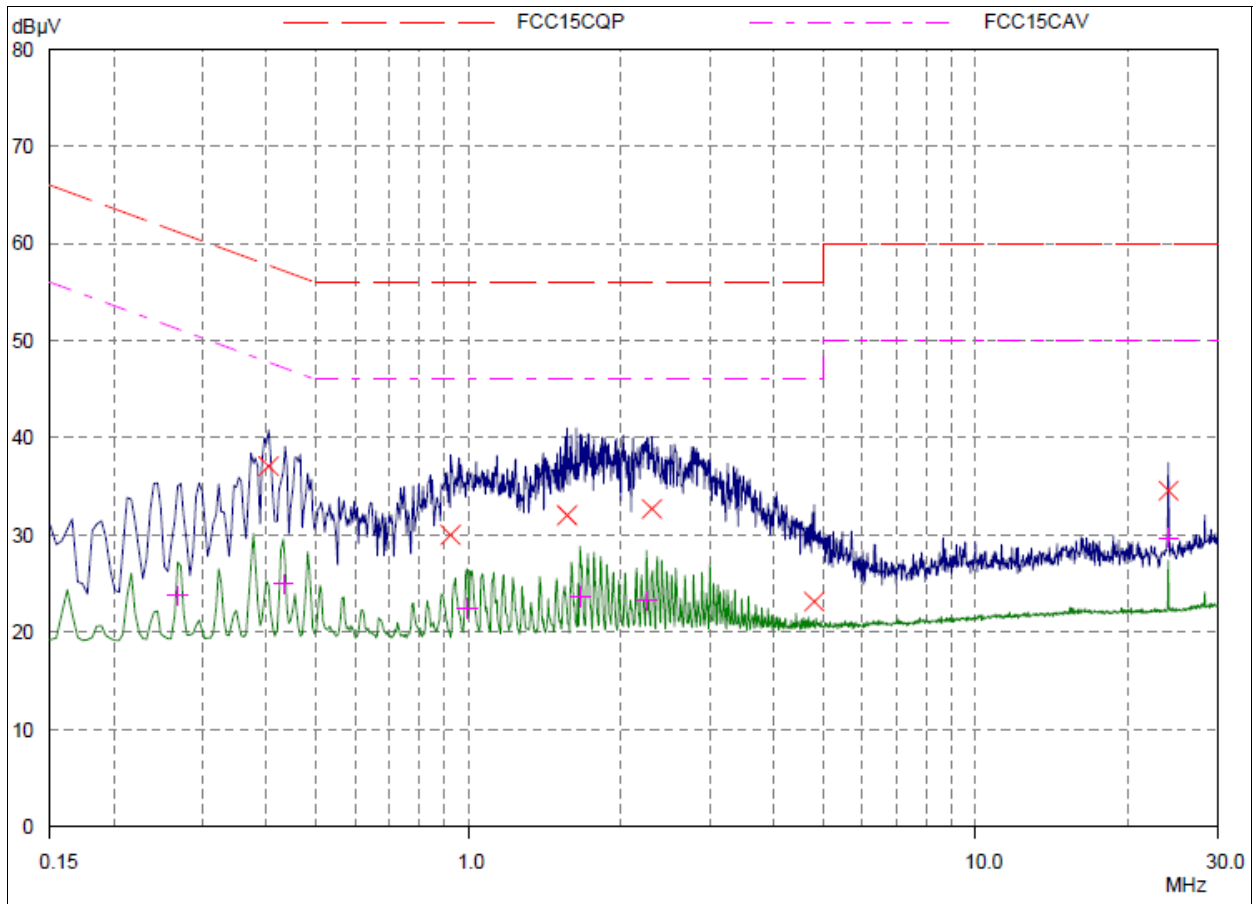

L Line

Final Measurement Results				
Frequency MHz	QP Level dB $\mu$ V	QP Limit dB $\mu$ V	QP Delta dB	Phase -
0.4039	37.08	57.77	20.69	L1
0.92343	30.02	56.00	25.98	L1
1.56796	32.03	56.00	23.97	L1
2.30234	32.71	56.00	23.29	L1
4.81015	23.17	56.00	32.83	L1
23.99765	34.58	60.00	25.42	L1
Frequency MHz	AV Level dB $\mu$ V	AV Limit dB $\mu$ V	AV Delta dB	Phase -
0.26718	23.79	51.21	27.42	L1
0.43125	24.96	47.23	22.27	L1
0.99375	22.49	46.00	23.51	L1
1.66171	23.64	46.00	22.36	L1
2.24765	23.28	46.00	22.72	L1
23.99765	29.73	50.00	20.27	L1

# TA Technology (Shanghai) Co., Ltd. Test Report

Report No.: RXA1409-0216RF01R1

Page 92of 96

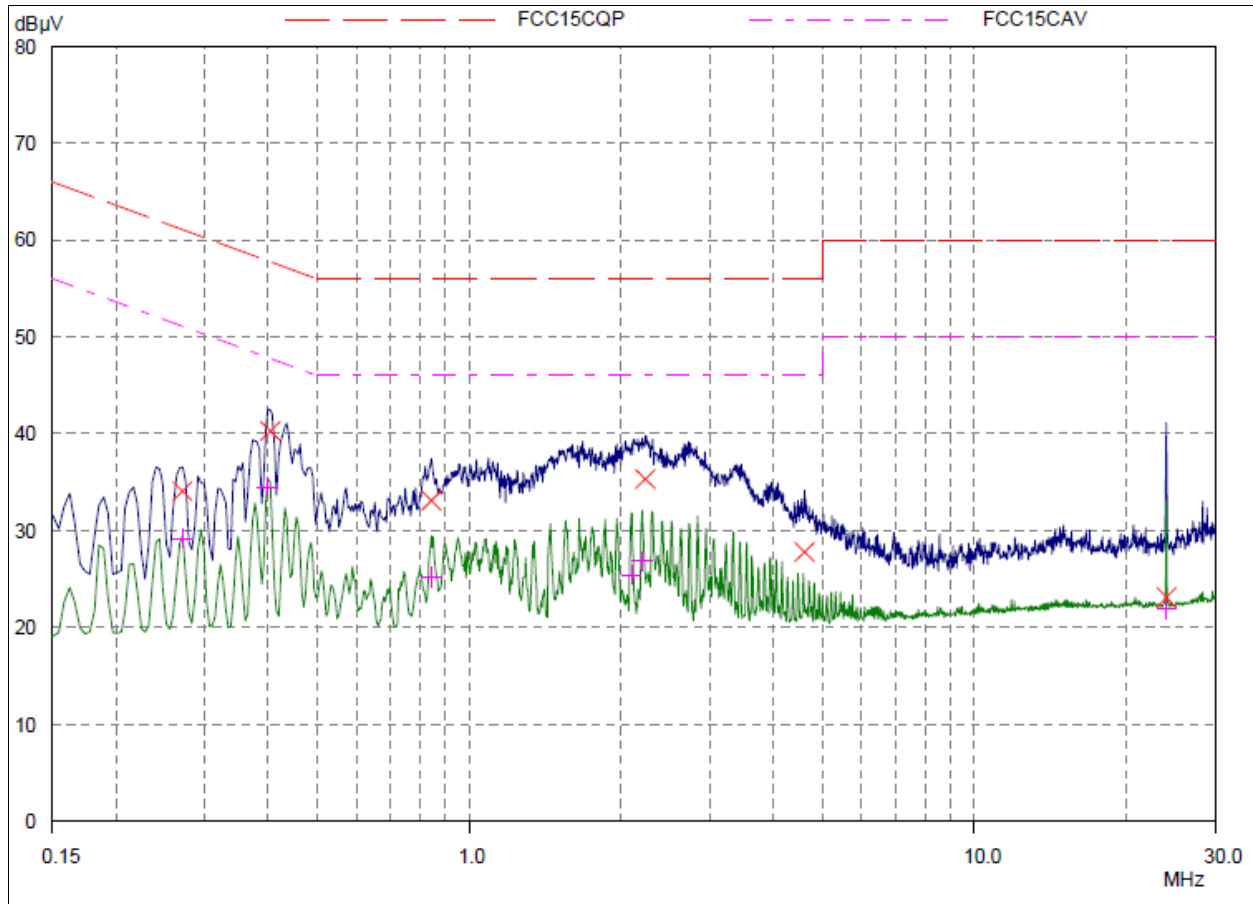

N Line

Final Measurement Results				
Frequency MHz	QP Level dBµV	QP Limit dBµV	QP Delta dB	Phase -
0.27109	34.09	61.08	26.99	N
0.4039	40.30	57.77	17.47	N
0.8414	33.10	56.00	22.90	N
2.23593	35.34	56.00	20.66	N
4.61875	27.78	56.00	28.22	N
23.99765	23.12	60.00	36.88	N
Frequency MHz	AV Level dBµV	AV Limit dBµV	AV Delta dB	Phase -
0.27109	29.18	51.08	21.90	N
0.4	34.51	47.85	13.34	N
0.8414	25.26	46.00	20.74	N
2.09531	25.42	46.00	20.58	N
2.20078	26.83	46.00	19.17	N
23.99765	21.87	50.00	28.13	N

**TA Technology (Shanghai) Co., Ltd.**  
**Test Report**

Report No.: RXA1409-0216RF01R1

Page 93of 96

## 2. Main Test Instruments

No.	Name	Type	Manufacturer	Serial Number	Calibration Date	Valid Period
01	EMI Test Receiver	ESCI	R&S	100948	2014-05-26	One year
02	Loop Antenna	FMZB1516	SCHWARZBECK	237	2014-06-29	Two years
03	TRILOG Broadband Antenna	VULB 9163	Schwarzbeck	9163-201	2013-11-25	Three years
04	Double Ridged Waveguide Horn Antenna	HF907	R&S	100126	2012-07-02	Three years
05	Standard Gain Horn	3160-09	ETS-Lindgren	00102644	2012-05-20	Three years
06	EMI Test Receiver	ESCS30	R&S	100138	2013-12-18	One year
07	LISN	ENV216	R&S	101171	2013-12-18	One year
08	Spectrum Analyzer	E4445A	Agilent	MY46181146	2014-05-26	One year
09	MOB COMMS DC SUPPLY	66319D	Agilent	MY43004105	2014-05-26	One year
10	Peak Power Meter	8990B	Agilent	51000109	2014-05-30	One year
11	Wideband Power Sensors	N1923A	Agilent	MY51220004	2014-05-30	One year
12	Spectrum Analyzer	FSV30	R&S	100815	2013-12-18	One year

\*\*\*\*\*END OF REPORT BODY\*\*\*\*\*

## ANNEX A: EUT Appearance and Test Setup

### A.1 EUT Appearance

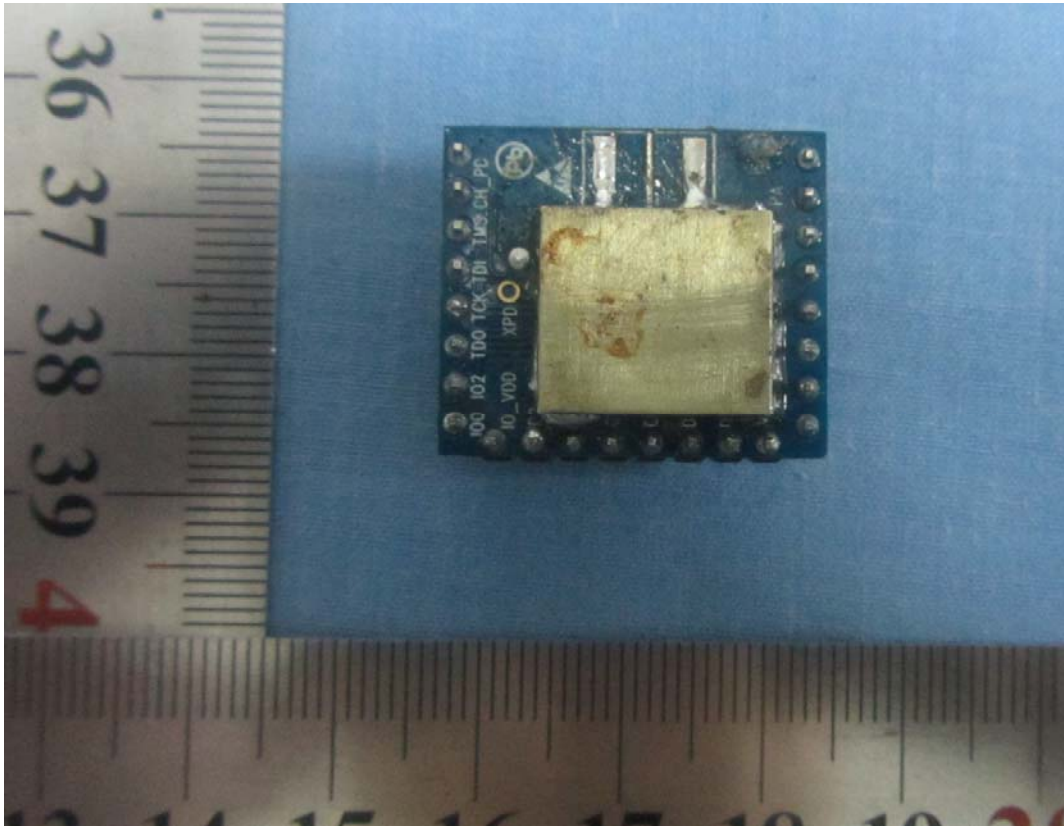

a: EUT

Picture 1 Constituents of EUT

## A.2 Test Setup



30M Hz-1GHz

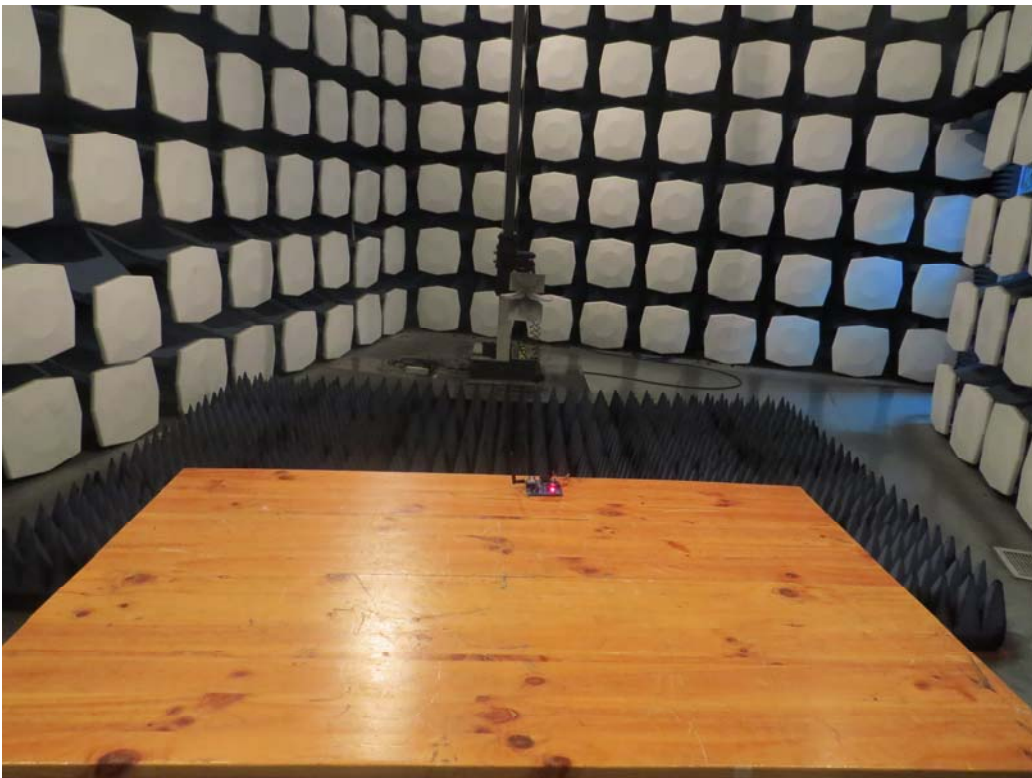

Above 1GHz

Picture 2 Radiated Emission Test Setup

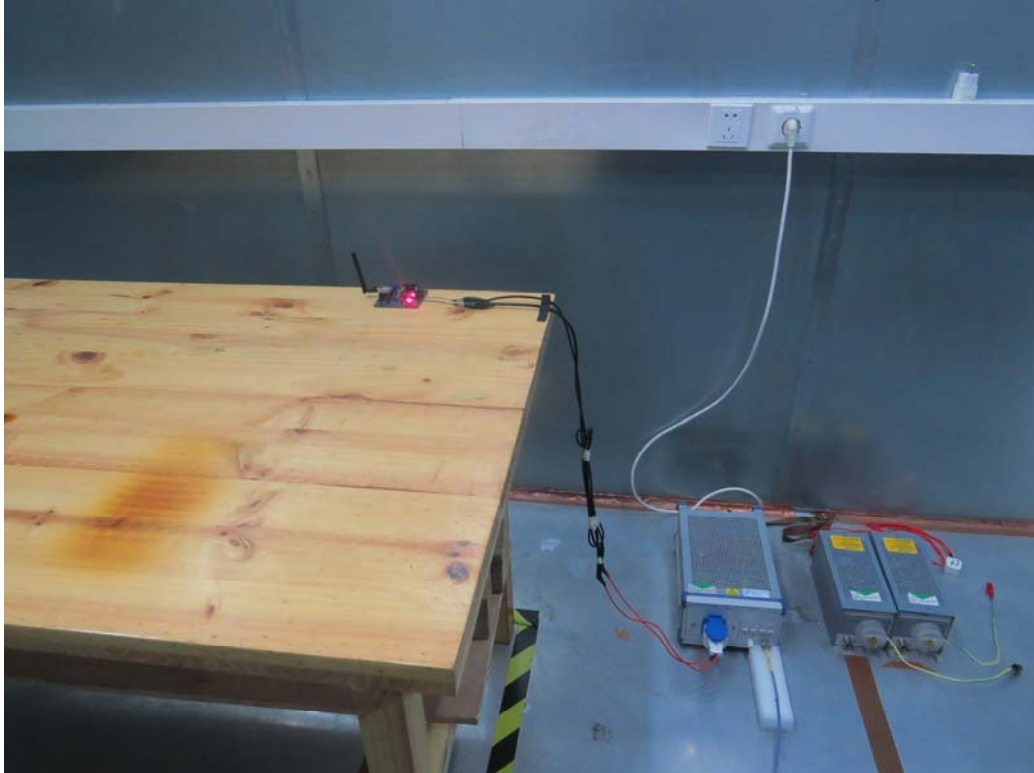

**Picture 3 Conducted Emission Test Setup**