

Raspberry_Pi_Hat_Connector

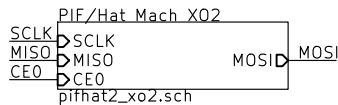
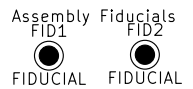
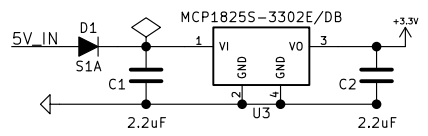
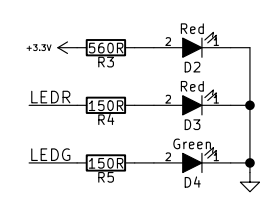
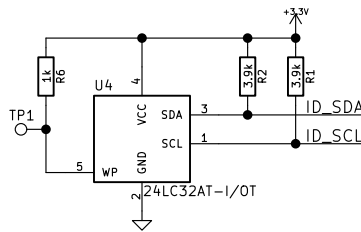
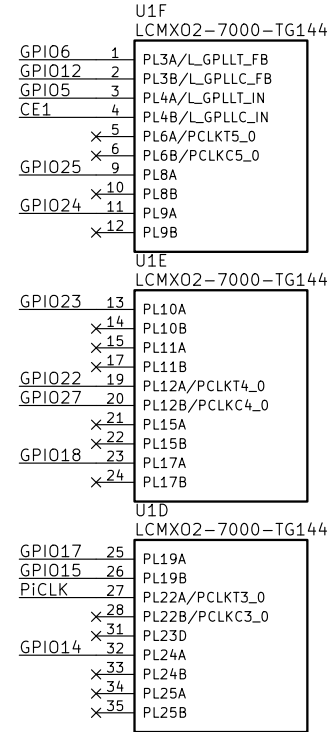
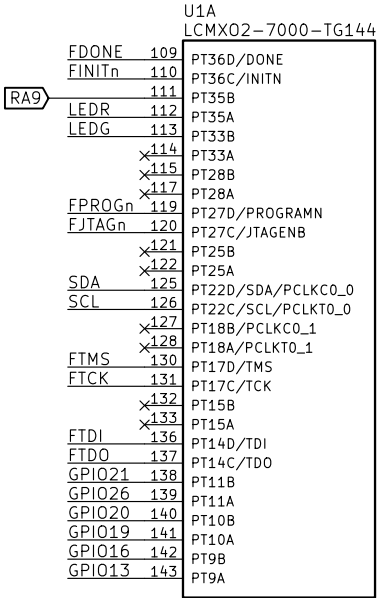
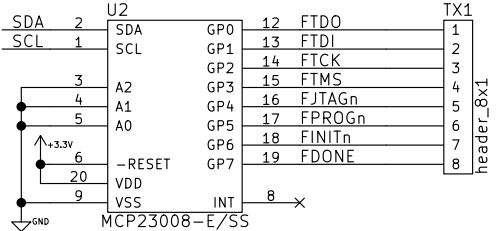

(c) 2016 Bugblat Ltd
 Sheet: /
 File: pifhat2.sch
Title: PIF 2 Raspberry Pi FPGA HAT
 Size: A4 Date: 2016-04-25
 KiCad E.D.A. kicad 4.0.2-stable Rev: 1
 Id: 1/2

U1B
LCMXO2-7000-TG144

RA0	73	PR24B
RB0	74	PR24A
RC0	75	PR23B
RA1	76	PR23A
RB1	77	PR21B
RC1	78	PR21A
RA2	81	PR18B
RB2	82	PR18A
RC2	83	PR17B
RA3	84	PR17A
RB3	85	PR16B
RC3	86	PR16A
RA4	87	PR15B
RB4	89	PR15A
RC4	91	PR12B/PCLKC1_0
RA5	92	PR12A/PCLKT1_0
RB5	93	PR11B
RC5	94	PR11A
RA6	95	PR9B
RB6	96	PR9A
RC6	97	PR7B
RA7	98	PR7A
RB7	99	PR5B
RC7	100	PR5A
RC8	103	PR4C
RB8	104	PR3B/R_GPLL_C_IN
RA8	105	PR3A/R_GPLL_C_IN
RC9	106	PR2B/R_GPLL_C_FB
RB9	107	PR2A/R_GPLL_C_FB

U1C
LCMXO2-7000-TG144

BA0	38	PB4A
BB0	39	PB4B
	40	PB6A/CSSPIN
	41	PB6B
BA1	42	PB9A
BB1	43	PB9B
	44	PB12A/MCLK/CCLK
SCLKD	45	PB12B/SO/SPI0
MISOD	47	PB13A
	48	PB13B
	49	PB16A/PCLKT2_0
	50	PB16B/PCLKC2_0
	52	PB18A
	54	PB18B
	55	PB23A/PCLKT2_1
	56	PB23B/PCLKC2_1
	57	PB26A
	58	PB26B
	59	PB29A
	60	PB29B
BB4	61	PB31A
BA4	62	PB31B
	63	PB31D
BB5	65	PB35A
BA5	67	PB35B
BB6	68	PB37A
BA6	69	PB37B
CE0	70	PB38A/SN
MOSI	71	PB38B/SI/SISPI

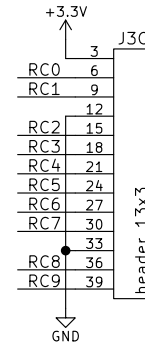
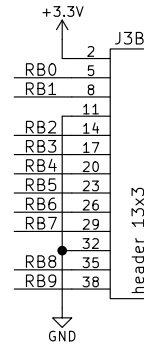
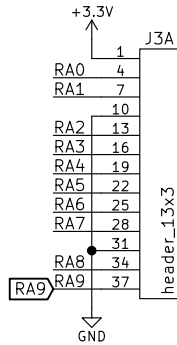
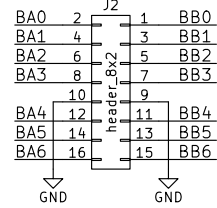

U1G
LCMXO2-7000-TG144

GND	8	GND
	18	GND
	29	GND
	46	GND
	53	GND
	64	GND
	80	GND
	90	GND
	101	GND
	116	GND
	124	GND
	134	GND
	129	NC
	36	VCC
	72	VCC
	108	VCC
	144	VCC
	118	VCCI00
	123	VCCI00
	135	VCCI00
	79	VCCI01
	88	VCCI01
	102	VCCI01
	51	VCCI02
	37	VCCI02
	66	VCCI02
	30	VCCI03
	16	VCCI04
+3.3V	7	VCCI05

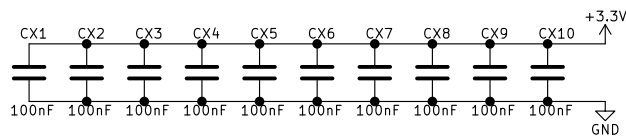

(c) 2016 Bugblat Ltd
 Sheet: /PIF/Hat Mach X02/
 File: pifhat2_xo2.sch
Title: PIF 2 Raspberry Pi FPGA HAT
 Size: A4 Date: 2016-04-25
 KiCad E.D.A. kicad 4.0.2-stable Rev: 1
 Id: 2/2