



ULN2803

LINEAR INTEGRATED CIRCUIT

EIGHT DARLINGTON ARRAYS

■ DESCRIPTION

The UTC **ULN2803** is high-voltage, high-current Darlington drivers comprised of eight NPN Darlington pairs.

■ FEATURES

- *Output current (single output) 500mA MAX.
- *High sustaining voltage output 50V MIN.
- *Output clamp diodes
- *Inputs compatible with various types of logic

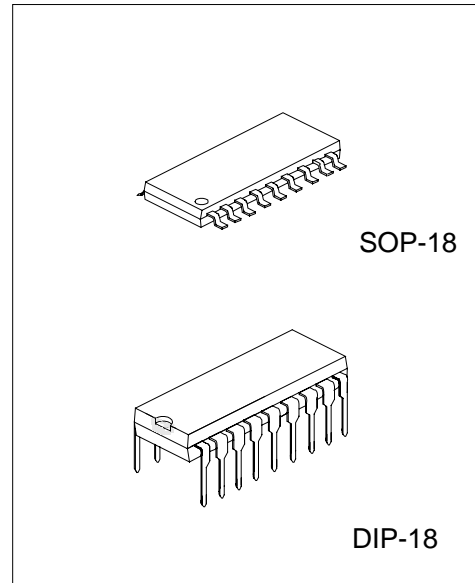

*Pb-free plating product number: ULN2803L

■ ORDERING INFORMATION

Order Number		Package	Packing
Normal	Lead Free Plating		
ULN2803-S18-R	ULN2803L-S18-R	SOP-18	Tape Reel
ULN2803-S18-T	ULN2803L-S18-T	SOP-18	Tube
ULN2803-D18-T	ULN2803L-D18-T	DIP-18	Tube

■ SCHEMATICS (EACH DRIVER)

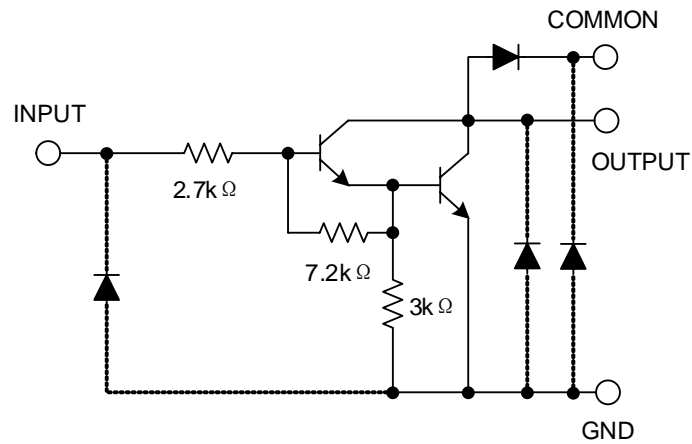

Note: The input and output parasitic diodes cannot be used as clamp diodes.

■ PIN CONFIGURATIONS

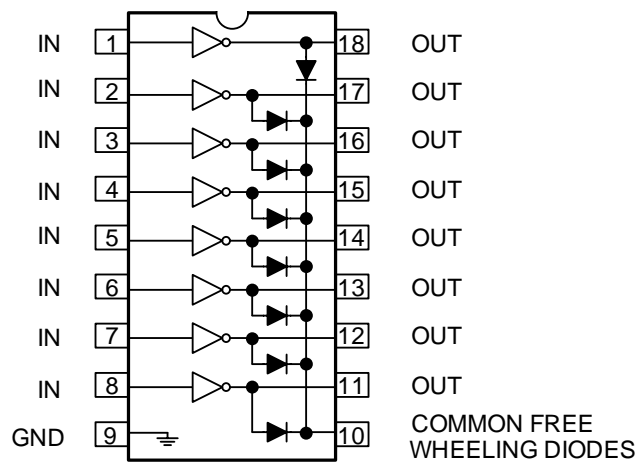

■ ABSOLUTE MAXIMUM RATINGS

PARAMETER	SYMBOL	RATINGS	UNIT
Input Voltage	V_{IN}	-0.5~30	V
Output Sustaining Voltage	$V_{CE(SUS)}$	-0.5~50	V
Output Current	I_{OUT}	500	mA/ch
Clamp Diode Reverse Voltage	VR	50	V
Clamp Diode Forward Current	I_F	500	mA
Power Dissipation	DIP-18	P_D	1.47
	SOP-18		0.54/0.625(Note)
Operating Temperature	T_{OPR}	0 ~ +70	°C
Storage Temperature	T_{STG}	-40 ~ +150	°C

Note 1. On glass epoxy PCB (30x30x1.6mm Cu 50%)

- Absolute maximum ratings are stress ratings only and functional device operation is not implied. The device could be damaged beyond Absolute maximum ratings.
- The device is guaranteed to meet performance specifications within 0°C~70°C operating temperature range and assured by design from -40°C~ 85°C.

■ ELECTRICAL CHARACTERISTICS (Ta=25°C, unless otherwise specified.)

PARAMETER	SYMBOL	TEST CIRCUIT	TEST CONDITIONS	MIN	TYP	MAX	UNIT	
Output Leakage Current	I_{CEX}	1	$V_{CE}=50V, T_a=25^\circ C$ $V_{CE}=50V, T_a=85^\circ C$			50 100	μA	
Collector-Emitter Saturation Voltage	$V_{CE(SAT)}$	2	$I_{OUT}=350mA, I_{IN}=500\mu A$ $I_{OUT}=200mA, I_{IN}=350\mu A$ $I_{OUT}=100mA, I_{IN}=250\mu A$		1.3 1.1 0.9	1.6 1.3 1.1	V	
Input Current	ON	$I_{IN(ON)}$	3	$V_{IN}=3.85V, I_{OUT}=350mA$		0.93	1.35	mA
	OFF	$I_{IN(OFF)}$	4	$I_{OUT}=500\mu A, T_a=85^\circ C$	50	65		μA
Input Voltage (output on)	$V_{IN(ON)}$	5	$V_{CE}=2.0V$ $I_{OUT}=200mA$ $I_{OUT}=250mA$ $I_{OUT}=300mA$			2.4 2.7 3.0	V	
Clamp Diode Reverse Current	I_R	6	$V_R=50V, T_a=25^\circ C$ $V_R=50V, T_a=85^\circ C$			50 100	μA	
Clamp Diode Forward Voltage	V_F	7	$I_F=350mA$			2.0	V	
Input Capacitance	C_{IN}				15	25	pF	
Turn-On Delay	t_{ON}	8	$V_{OUT}=50V, R_L=125\Omega, C_L=15pF$		0.1	1	μS	
Turn-Off Delay	t_{OFF}	8	$V_{OUT}=50V, R_L=125\Omega, C_L=15pF$		0.2	1	μS	

■ TEST CIRCUIT

1. I_{CEX}

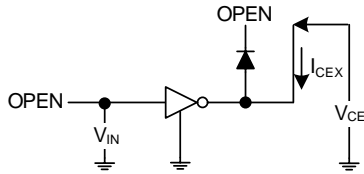

2. $V_{CE(sat)}$, h_{FE}

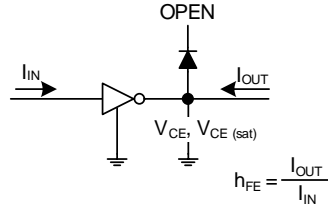

3. $I_{IN(ON)}$

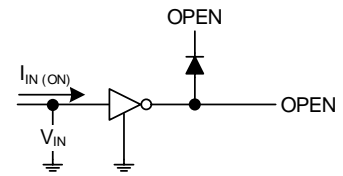

4. $I_{IN(OFF)}$

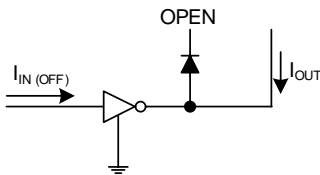

5. $V_{IN(ON)}$

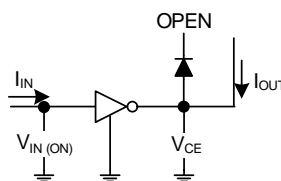

6. I_R

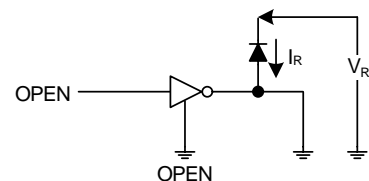

7. V_F

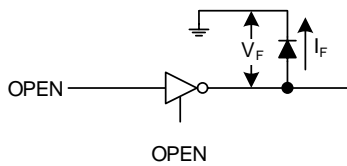

8. t_{ON} , t_{OFF}

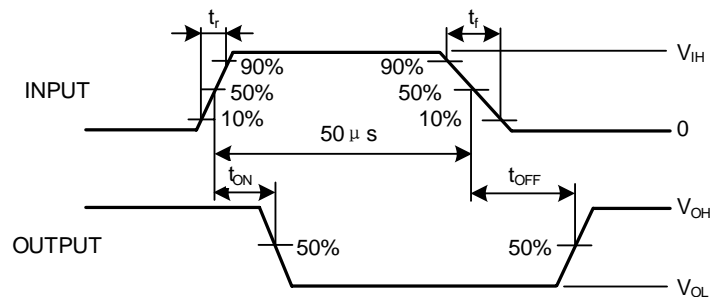
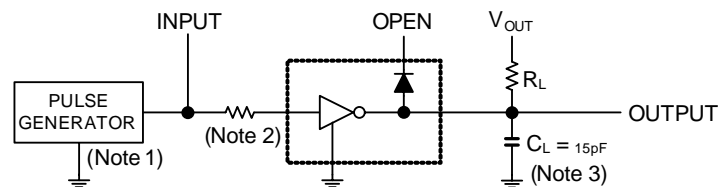

Note1: Pulse width 50µs, duty cycle 10%

Output impedance 50Ω, $t_r \leq 5ns$, $t_f \leq 10ns$

Note2: $R_1 = 0$, $V_{IH} = 3V$

Note3: C_L includes probe and jig capacitance.

TYPICAL CHARACTERISTICS

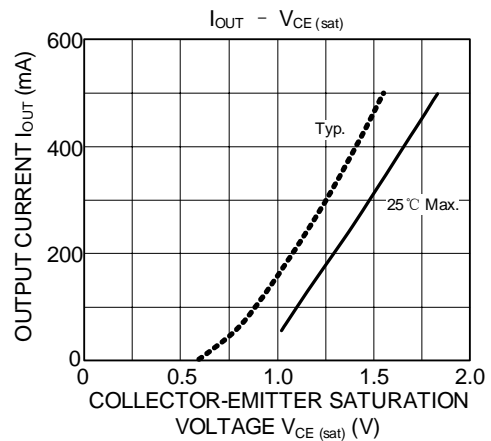
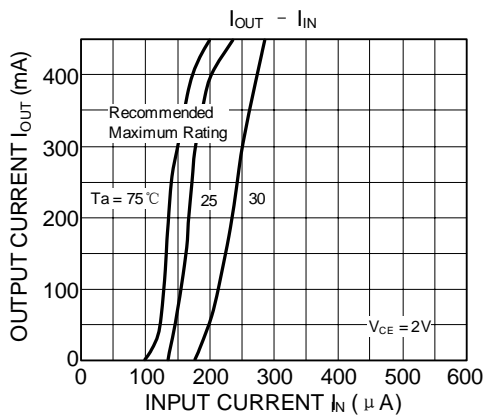
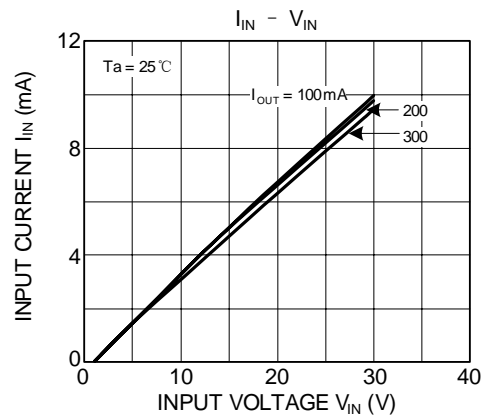
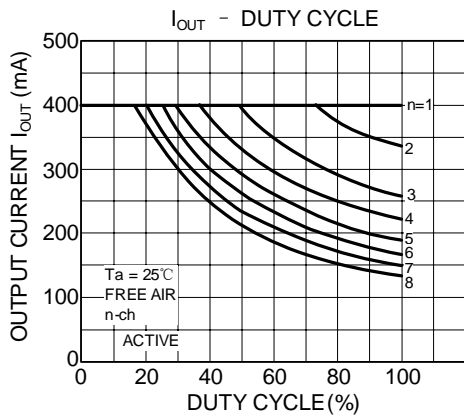
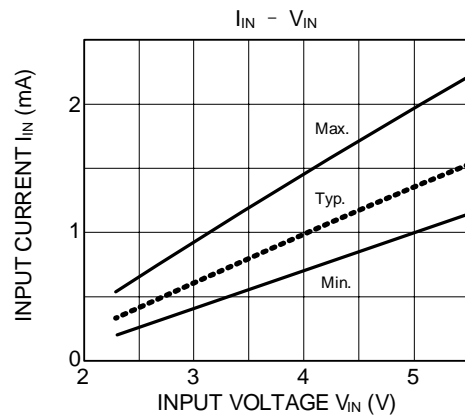
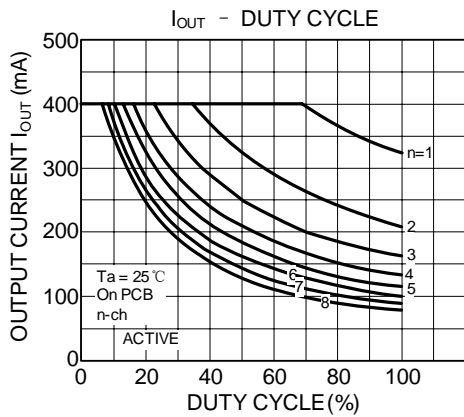

■ TYPICAL CHARACTERISTICS(cont.)

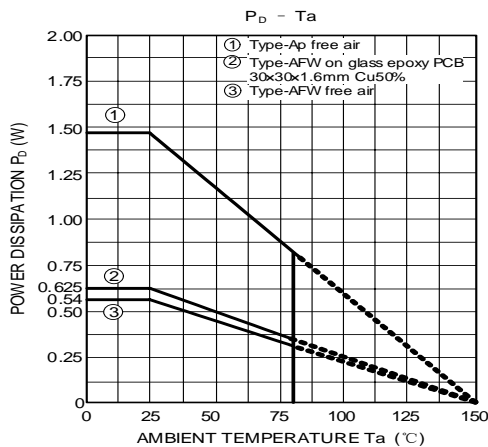
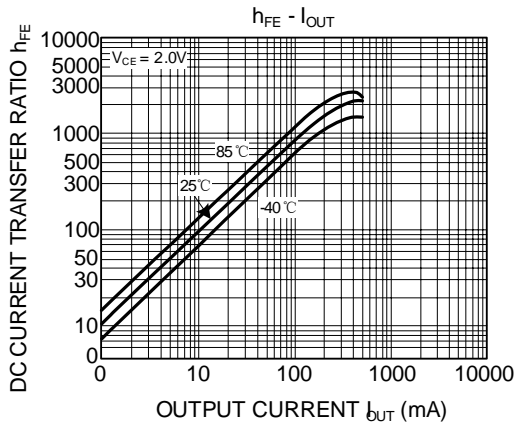
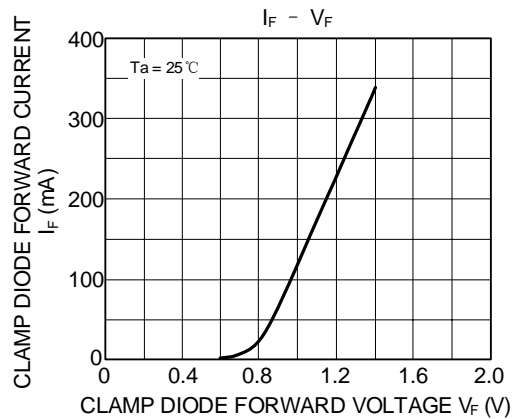
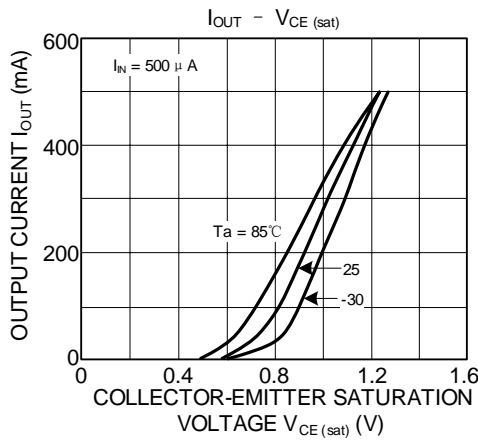

UTC assumes no responsibility for equipment failures that result from using products at values that exceed, even momentarily, rated values (such as maximum ratings, operating condition ranges, or other parameters) listed in products specifications of any and all UTC products described or contained herein. UTC products are not designed for use in life support appliances, devices or systems where malfunction of these products can be reasonably expected to result in personal injury. Reproduction in whole or in part is prohibited without the prior written consent of the copyright owner. The information presented in this document does not form part of any quotation or contract, is believed to be accurate and reliable and may be changed without notice.