

PRODUCT INFORMATION

D/106/3/12/0

December 1980

FUNCTIONAL SCHEMATIC

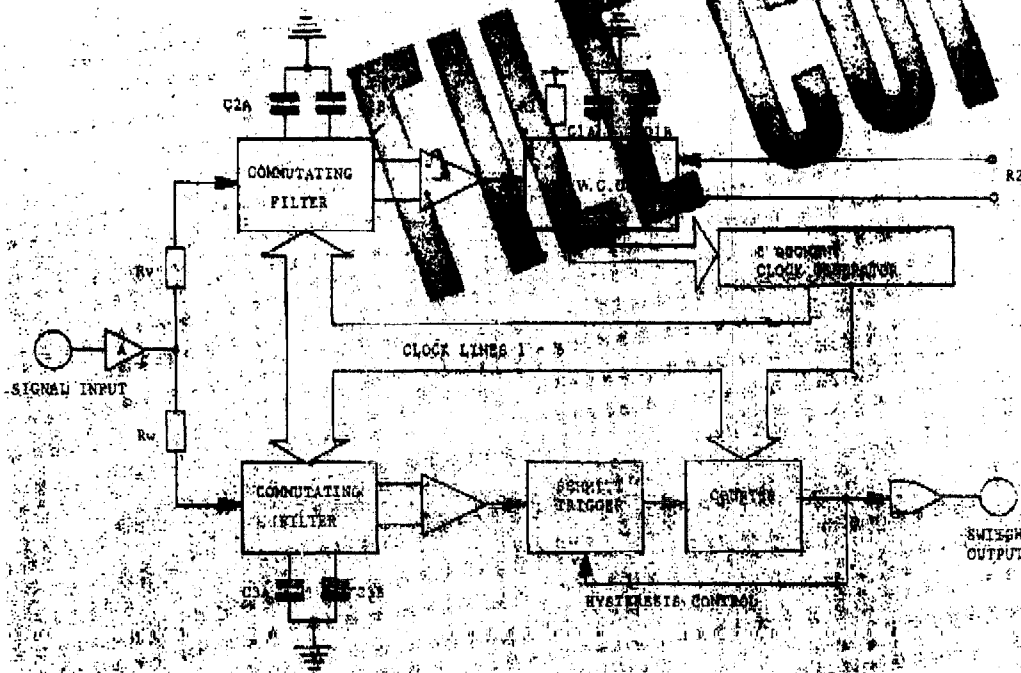

FX 105 TONE DETECTOR

FEATURES

- * OPERATES IN HIGH NOISE CONDITIONS
- * ≥ 40 dB SIGNAL INPUT RANGE
- * SIMULTANEOUS TONE DETECTION
- * ADJUSTABLE BANDWIDTH
- * HERMETICALLY SEALED CERAMIC PACKAGE
- * WIDE FREQUENCY RANGE

DESCRIPTION

The FX-105 is a monolithic tone operated switch, designed for tone decoding in single and multitone signalling systems.

The device employs decoding techniques which allow tones to be recognised in the presence of high noise levels or strong adjacent channel tones.

Tone channel centre frequency and channel bandwidth can each be adjusted independently. The circuit has a high noise immunity against harmonic and sub-harmonic responses and is able to maintain a constant bandwidth and high noise immunity over a wide range of input signal levels.

V.C.O. SAMPLING WAVEFORMS FIG. 2

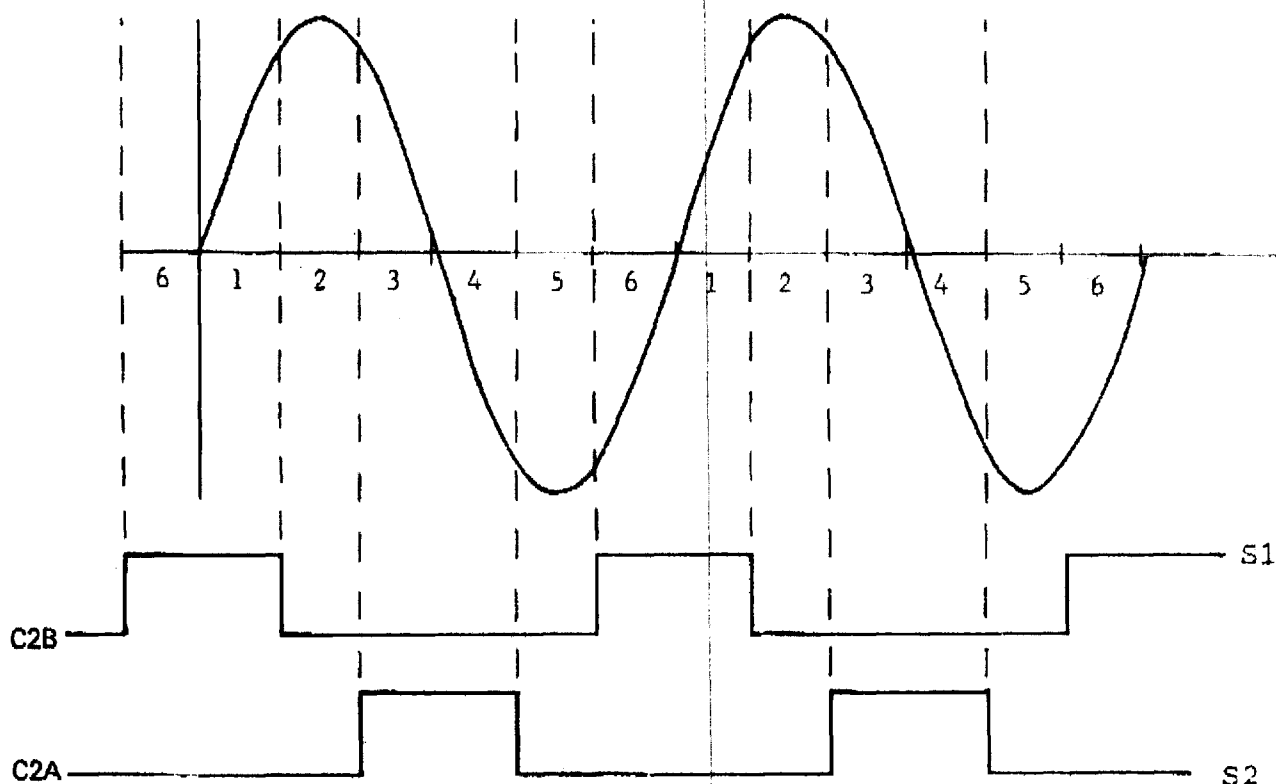

METHOD OF OPERATION

Input signals are A.C. coupled to the buffer input, which is internally biased at 50% of supply voltage, the signal appears at the output of the buffer as an A.C. voltage superimposed on the D.C. bias level. The signal is then coupled via RV and RW to the voltage controlled oscillator and word sampling switches, which sequentially connect C2 and C3 into circuit to form four sample and hold RC integrators.

With no input signal, each capacitor charges to the D.C. bias level and differential voltages are zero. When an input signal is applied, each capacitor receives an additional charge according to the integrated average of the signal waveform during the interval the capacitor is switched into circuit.

Figure 2 above shows the operating sequence of the V.C.O. sampling switches and their phase relationship to a locked on inband signal. As can be seen from Figure 2 C2A and C2B should not receive any additional charge as they always sample the input as it crosses the D.C. bias level. Should the signal not be locked to the V.C.O. then a positive or negative charge voltage will appear on C2A or

C2B, this voltage when differentially amplified is applied to the V.C.O. as an error correcting signal to enable the V.C.O. to achieve lock.

Figure 3 shows the operating sequence of the 'Word' sampling switches and their relationship to a locked on inband signal. As can be seen from Figure 3 the charge being applied to C3A should always be positive and the charge applied to C3B should always be negative with respect to the common bias level.

These capacitor potentials are differentially amplified and applied to a D.C. comparator, which switches at a predetermined threshold voltage. The comparator output is a logic signal used to control a counter which switches the FX-105 output ON when the comparator output is maintained in the 'Word Present' state for a minimum number of consecutive signal samples. The output switch reduces the comparator threshold by 50% when turned on, thereby introducing threshold hysteresis which minimises output chatter with marginal input signal amplitudes.

WORD SAMPLING WAVEFORMS FIG. 3

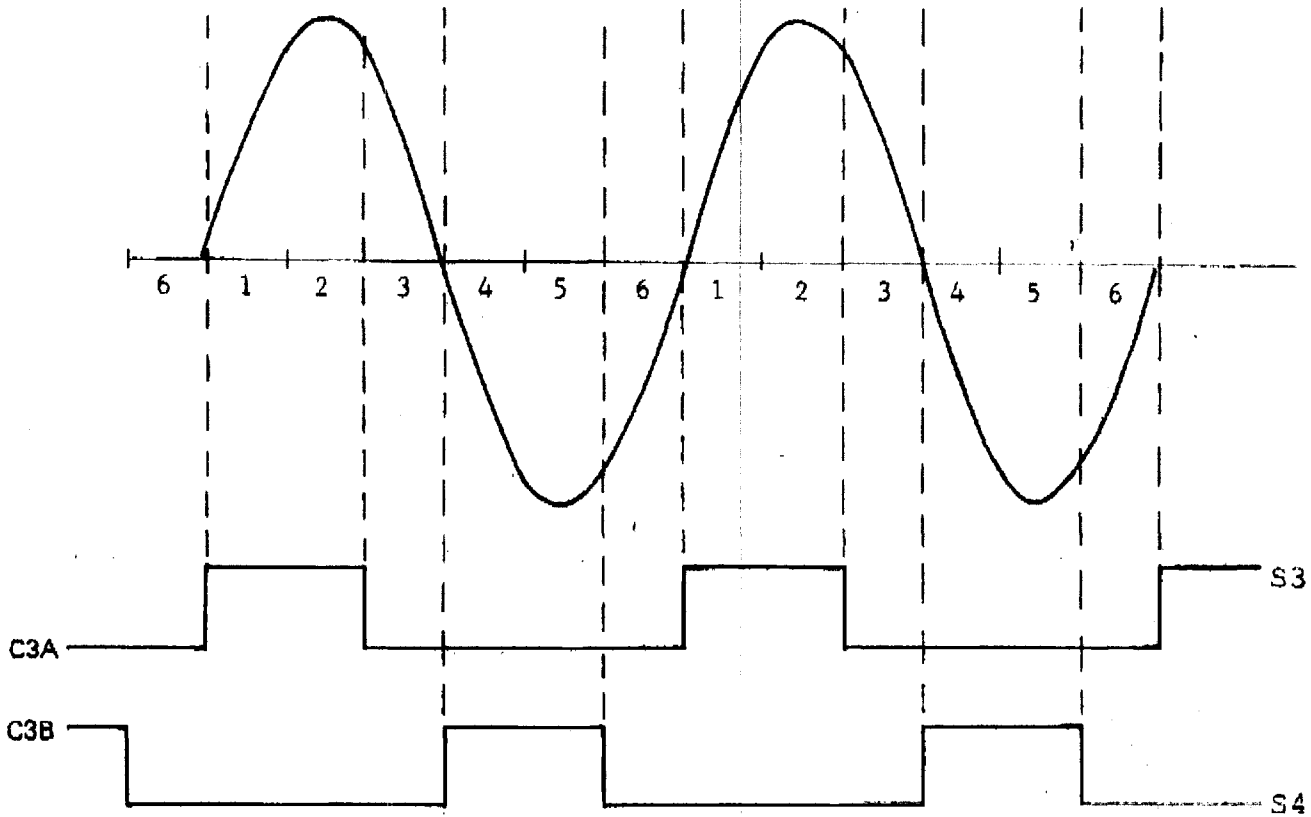

METHOD FOR CALCULATING EXTERNAL COMPONENT VALUES

The external components shown below in Figure 4 are used to adjust the various performance parameters of the FX-105. The signal to noise performance, turn on delay and signal bandwidth are all interrelated factors which should be optimised to meet the requirements of the application.

By selecting component values in accordance with the following graphs nominally optimum circuit performance is obtained for any given application.

The user should first define the following application parameters.

- A. The centre frequency to be detected ($f'o$).
- B. The FX-105 Minimum Usable Bandwidth (MUBW). This is obtained by taking into account the worst case tolerances on the input tone frequency and variations in the FX-105 $f'o$ due to supply voltage (0.07%/%) and ambient temperature (0.02%/°C) changes.
- C. The maximum permissible FX-105 response time.
- D. The minimum input signal amplitude.

Using this information the appropriate component values can be calculated, and the signal to noise performance obtained may then be read from a chart.

Using the graphs overleaf the following worked example may be used to calculate component values for any given application.

- A. FX-105 centre band frequency ($f'o$) = 2800Hz.
- B. FX-105 bandwidth = 6%.
- C. FX-105 maximum response time = 50ms.
- D. Minimum input signal amplitude = 200mVolts R.M.S.

FIG. 4

FX105 EXTERNAL COMPONENT CONNECTIONS

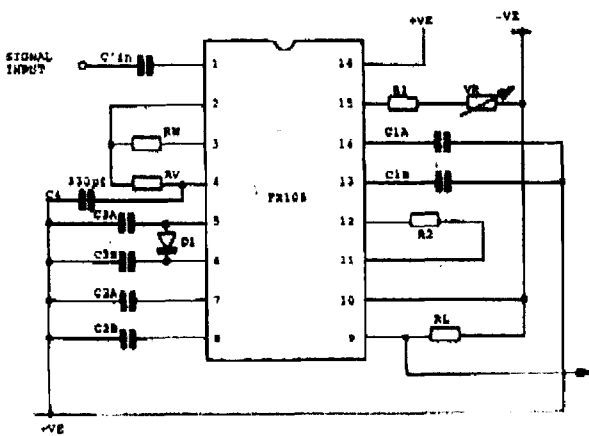

R1 C1A C1B

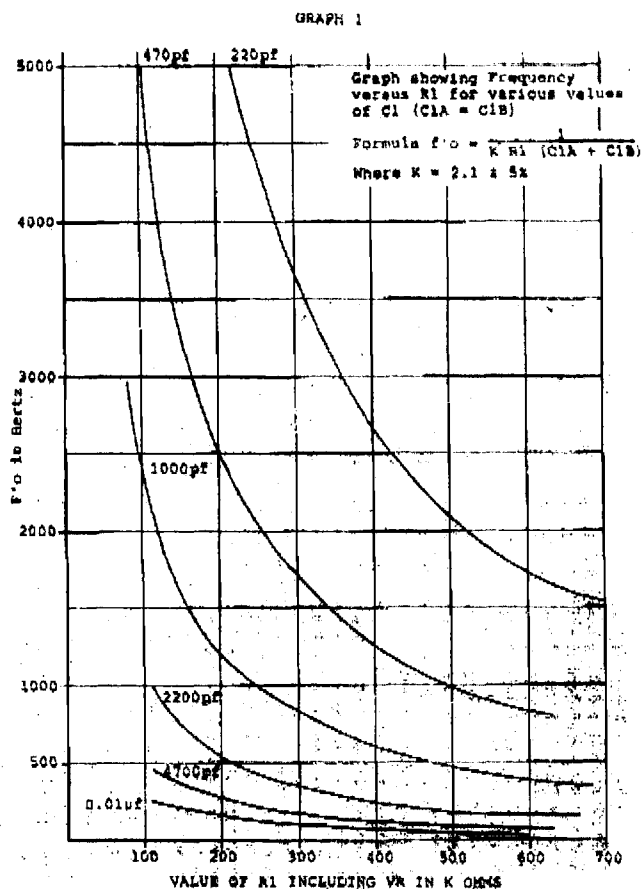

These components set the free running frequency of the V.C.O. and thereby the centre band frequency of the FX-105.

By using graph number 1 the frequency 2800Hz can be seen to correspond to a value of capacitor of 220 picofarads and a resistor value of 385k ohms, this resistance can be achieved with a 300k ohm fixed resistor for R1 and a 100k ohm potentiometer.

Graph number 2 shows that for a frequency of 2900Hz and a bandwidth of 6% a resistor RV of 200k ohms and a capacitance for C2A and C2B of 0.01 microfarads will be required.

The response time of the FX-105 is the sum of the V.C.O. 'Lock' time (T'lock) and the 'Word' integration time (T'word).

Graph number 3 shows that for a frequency of 2800Hz and a bandwidth of 6% the approximate 'Lock' time will be 9 milliseconds, as we have a maximum response time of 50 milliseconds, this allows for a 'Word' time of 41 milliseconds.

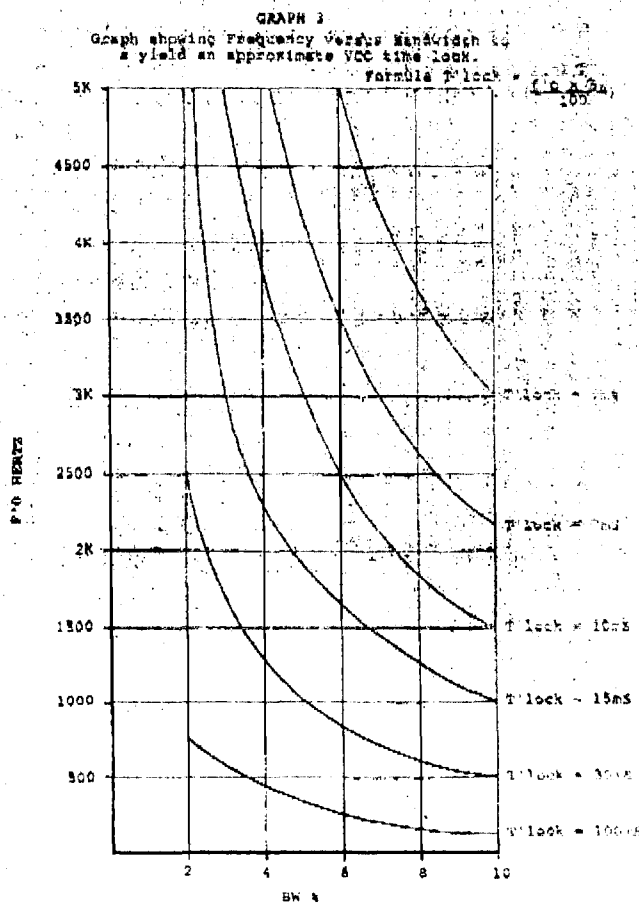
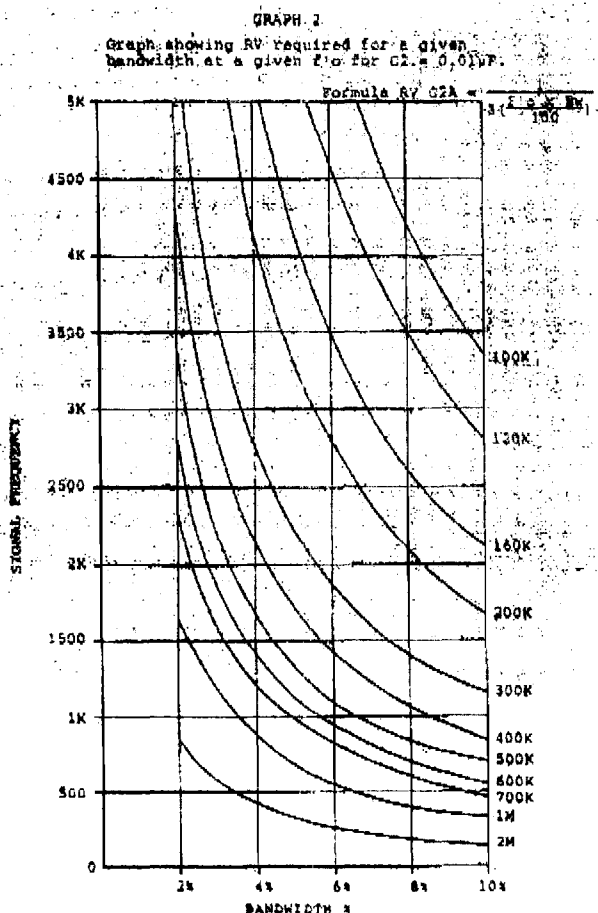

GRAPH 4

Graph showing RM required for T'word for a given signal input assuming $C3A = C3B = 0.107$. Formulae T'word = $R \times C3A \times K$ (given in Graph 5.)

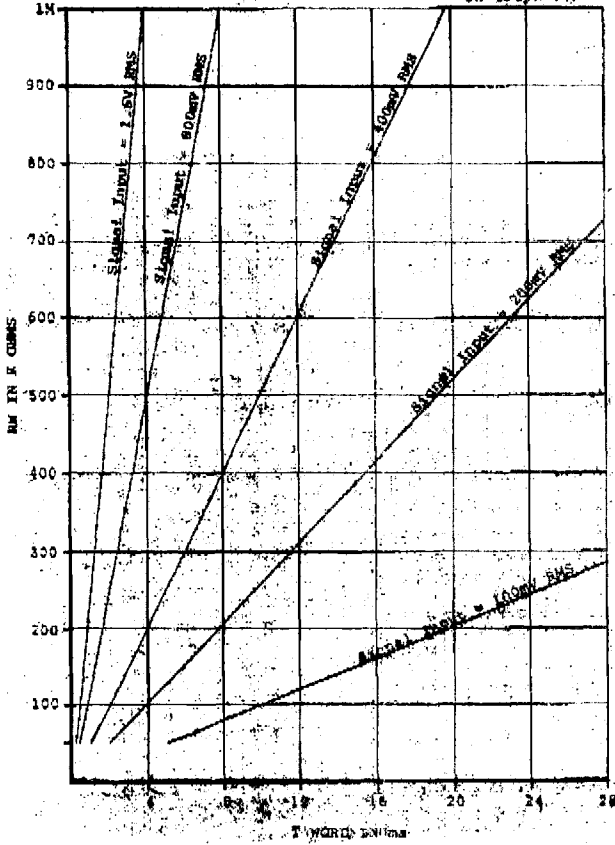

GRAPH 5

GRAPH SHOWING K FACTOR VS SIGNAL INPUT AMPLITUDE.

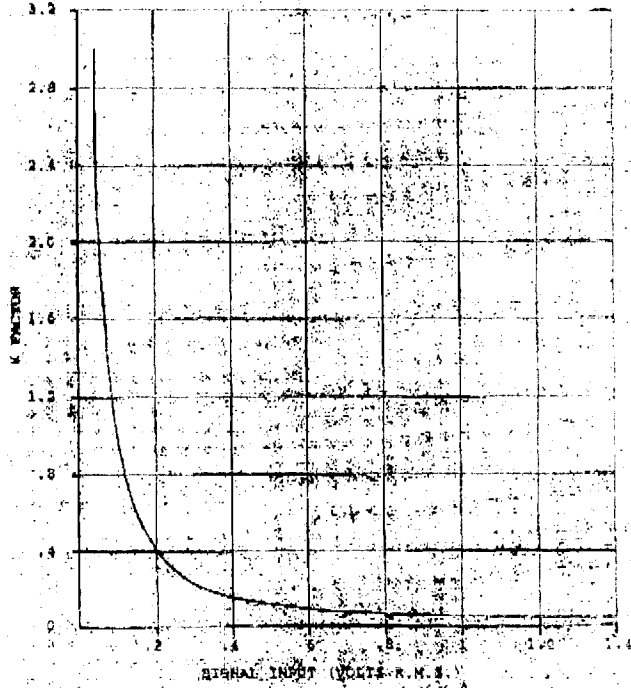

GRAPH 6

GRAPH SHOWING VALUE OF R2 (KΩ) TO YIELD SELECTED BANDWIDTH (Δ)

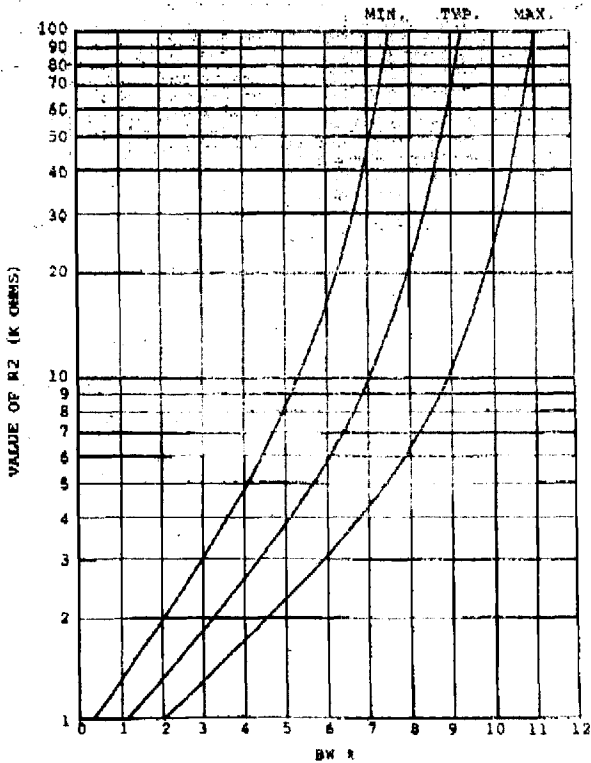

GRAPH 7

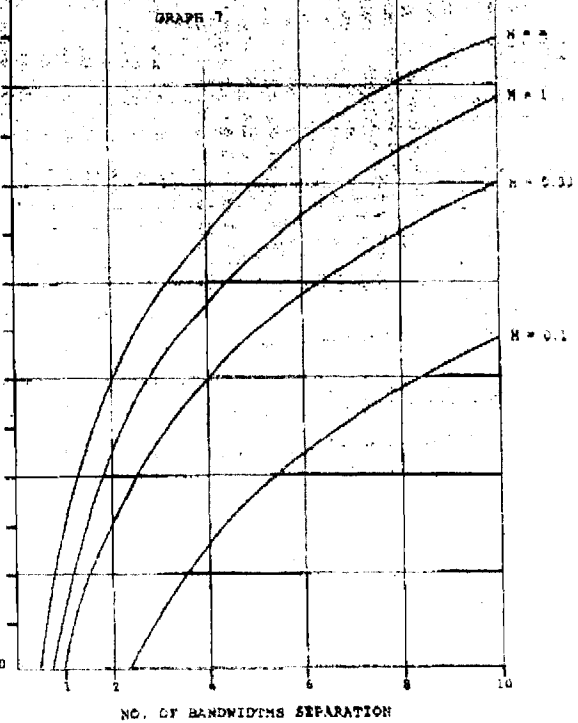

Graph number 4 shows that for a signal amplitude of 200mVolts, a resistor value RW of 510k ohms with a 0.1 microfarad capacitor for C3A and B will yield a 'Word' time of 20ms. This will yield a response time of 9ms + 20ms = 29ms.

Graph 6 shows the range of values for R2 to yield a given bandwidth. The exact bandwidth given by any value of R2 will vary with differing production batches, therefore in applications where an exact bandwidth is required R2 should be a variable resistor which is adjusted on test.

To calculate the worst case signal to noise ratio the FX-105 will work with the above component values. The formula is as follows:

$$M = \frac{f_o \times Bw}{100} \times (Rw \ C3A)$$

$$\therefore M = \frac{2800 \times 6}{100} \times (0.51M\Omega \times 0.1\mu F)$$

$$\therefore M = 168 \times 0.051$$

$$\therefore M \approx 8.57$$

By substituting the value for M of 8.57 in graph number 7 the signal to noise ratio of an adjacent tone can be found, this then has to be decreased depending upon the tone amplitude. The figure to decrease SNR by is given in graph 8.

Graphs 9 and 10 show the approximate time the FX-105

will take to turn off after an inband signal has been removed. The turn off time is calculated with a diode (1N914 or similar) between pins 5 and 6 as shown in Figure 4. The effect of this diode is to greatly reduce the turn off time with signal input amplitudes greater than 300mV R.M.S.

GRAPH 8

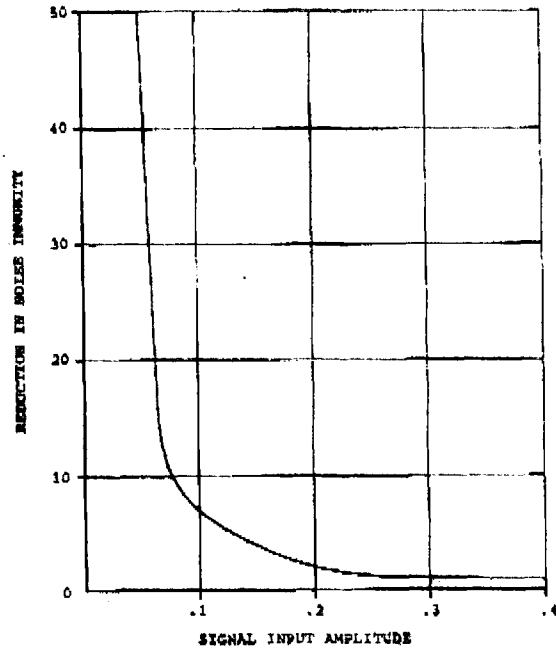

GRAPH 9
Graph showing T'off time for a given signal amplitude C3 = 0.1uF and Diode D1 between C3A & C3B.

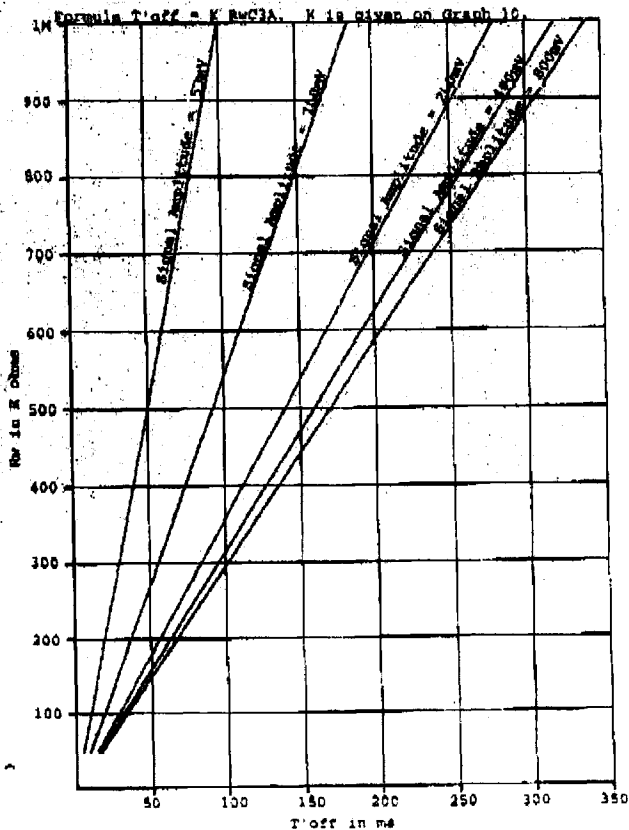

GRAPH 10
Graph showing 'K' factor for T'off vs signal input amplitude (volts RMS).

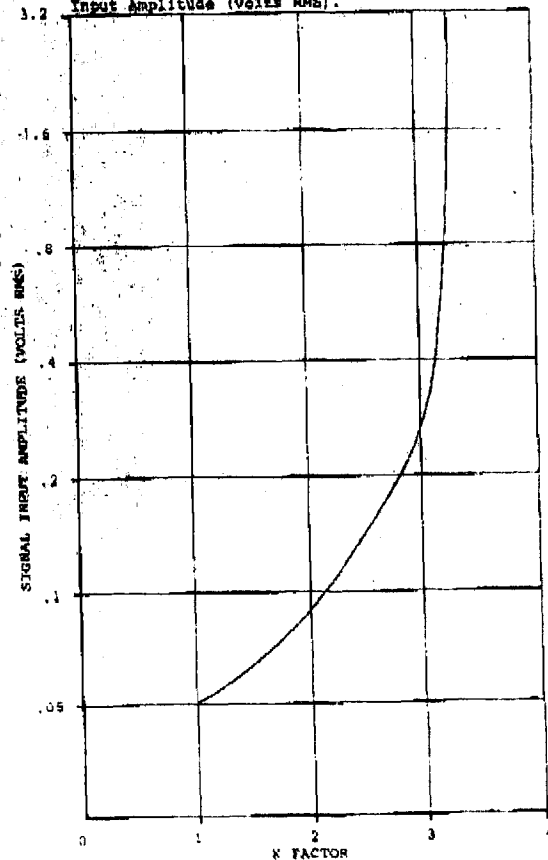

SPECIFICATION

MAX. RATINGS Failure to observe may result in device damage.

MAX. VOLTAGE BETWEEN ANY PIN AND +VE SUPPLY (pin 16).....	-20V and +0.3V
OPERATING TEMPERATURE RANGE.....	-30°C to +85°C
STORAGE TEMPERATURE RANGE.....	-55°C to +125°C
DEVICE DISSIPATION (at 20°C ambient temperature).....	400mW
MAX. OUTPUT SWITCH LOAD CURRENT.....	10mA

CHARACTERISTICS

Note: Due to A.C. signal coupling either supply polarity may be 'ground'.

SYMBOL	PARAMETER	NOTES	MIN.	TYP.	MAX.	UNITS
V_s	Supply voltage	Operating range	10	12	15	Volts
I_s	Supply current	Total, excluding loads		5		mA
	Signal Input	Signal + noise range	0.055		5 ¹	Volts R.M.S.
F_o	Channel Frequency		0.04		5	kHz
Bw	Bandwidth		2%		10%	
	O/P switch load current				10	mA
Z_{in}	Input impedance			200		k ohm
	Frequency Stability	vs T'AMB		0.02%/°C		
	Frequency Stability	Per 1% change in supply volts		0.07%		

NOTE

- For input voltages greater than $V_{DD} \times 0.143$ pins 1 and 2 should be open circuit and the signal applied via C'in to the junction of RV and RW.

PACKAGE DETAILS 16 LEAD DUAL IN LINE CERAMIC PACKAGE

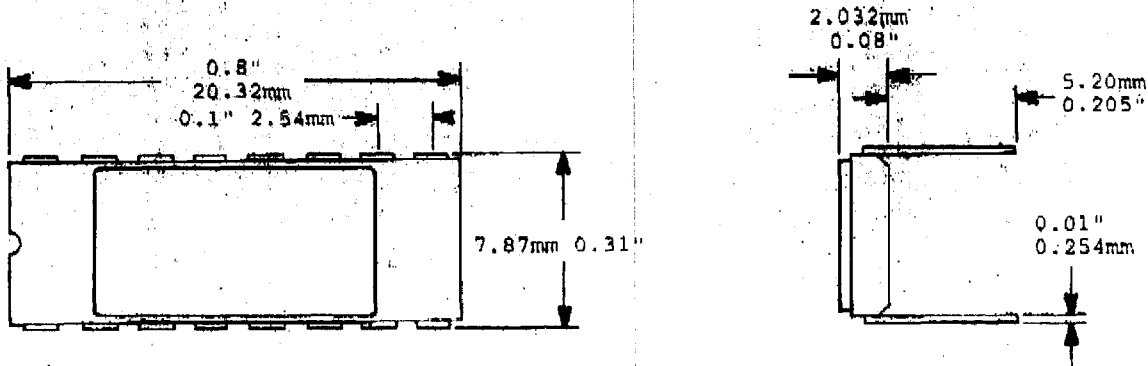

CML DOES NOT ASSUME ANY RESPONSIBILITY FOR THE USE OF ANY CIRCUITRY DESCRIBED. NO CIRCUIT PATENT LICENCES ARE IMPLIED AND CML RESERVES THE RIGHT AT ANY TIME WITHOUT NOTICE TO CHANGE SAID CIRCUITRY.

