

THS6214 Dual-Port, Differential, VDSL2 Line Driver Amplifiers

1 Features

- Low Power Consumption:
 - Full Bias Mode: 21 mA per Port
 - Mid Bias Mode: 16.2 mA per Port
 - Low Bias Mode: 11.2 mA per Port
 - Low-Power Shutdown Mode
 - I_{ADJ} Pin for Variable Bias
- Low Noise:
 - Voltage Noise: $2.7 \text{ nV}/\sqrt{\text{Hz}}$
 - Inverting Current Noise: $17 \text{ pA}/\sqrt{\text{Hz}}$
 - Noninverting Current Noise: $1.2 \text{ pA}/\sqrt{\text{Hz}}$
- Low MTPR Distortion:
 - 70 dB with 20.5 dBm G.993.2—Profile 8b
- –93 dBc HD3 (1 MHz, 100- Ω Differential)
- High Output Current: > 416 mA (25- Ω Load)
- Wide Output Swing: 43.2 V_{PP} ($\pm 12 \text{ V}$, 100- Ω Differential Load)
- Wide Bandwidth: 150 MHz ($G_{DIFF} = 10 \text{ V/V}$)
- PSRR: 50 dB at 1 MHz for Good Isolation
- Wide Power-Supply Range: 10 V to 28 V

2 Applications

- Ideal For VDSL2 Systems
- Backwards-Compatible with ADSL, ADSL2+, ADSL2++ Systems
- Broadband Power Line Communications

3 Description

The THS6214 is a dual-port, current-feedback architecture, differential line driver amplifier system ideal for xDSL systems. The device is targeted for use in very-high-bit-rate digital subscriber line 2 (VDSL2) line driver systems that enable greater than 14.5-dBm line power, supporting the G.993.2 VDSL2 17a profile. The device is also fast enough to support central-office transmissions of 14.5-dBm line power up to 30 MHz. The device is also targeted for use as a broadband or wideband power line communications (PLC) amplifier for line driver applications.

The unique architecture of the THS6214 uses minimal quiescent current and still achieves very high linearity. Differential distortion, under full bias conditions, is –93 dBc at 1 MHz and reduces to only –73 dBc at 10 MHz. Fixed multiple bias settings of the amplifiers allow for enhanced power savings for line lengths where the full performance of the amplifier is not required. To allow for even more flexibility and power savings, an adjustable current pin (I_{ADJ}) is available to further lower the bias currents.

The wide output swing of 43.2 V_{PP} (100- Ω differential load) with $\pm 12\text{-V}$ power supplies, coupled with over 416-mA current drive (25- Ω load), allows for wide dynamic headroom, keeping distortion minimal.

The THS6214 is available in a VQFN-24 or a HTSSOP-24 PowerPAD™ package.

Device Information⁽¹⁾

PART NUMBER	PACKAGE	BODY SIZE (NOM)
THS6214	VQFN (24)	5.00 mm x 4.00 mm
	HTSSOP (24)	7.80 mm x 4.40 mm

(1) For all available packages, see the orderable addendum at the end of the data sheet.

Typical VDSL2 Line Driver Circuit Using One Port of the THS6214

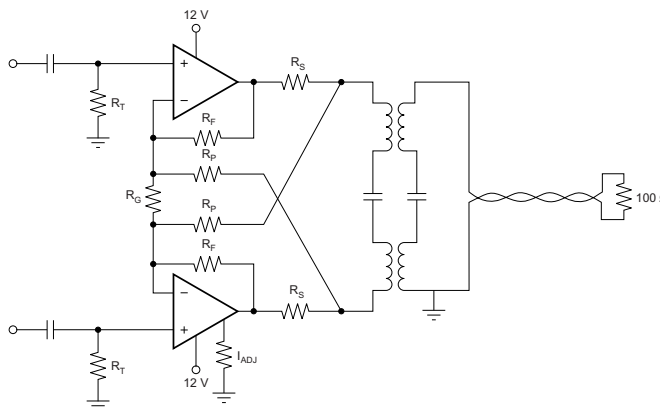

Table of Contents

1 Features	1	7 Detailed Description	25
2 Applications	1	7.1 Overview	25
3 Description	1	7.2 Functional Block Diagram	25
4 Revision History	2	7.3 Feature Description	25
5 Pin Configuration and Functions	3	7.4 Device Functional Modes	28
6 Specifications	4	8 Application and Implementation	29
6.1 Absolute Maximum Ratings	4	8.1 Application Information	29
6.2 ESD Ratings	5	8.2 Typical Applications	29
6.3 Recommended Operating Conditions	5	9 Power Supply Recommendations	35
6.4 Thermal Information	5	10 Layout	36
6.5 Electrical Characteristics: $V_S = \pm 12\text{ V}$	6	10.1 Board Layout Guidelines	36
6.6 Electrical Characteristics: $V_S = \pm 6\text{ V}$	8	10.2 Layout Example	37
6.7 Timing Requirements	10	11 Device and Documentation Support	38
6.8 Typical Characteristics: $V_S = \pm 12\text{ V}$, Full Bias	11	11.1 Receiving Notification of Documentation Updates	38
6.9 Typical Characteristics: $V_S = \pm 12\text{ V}$, Mid Bias	14	11.2 Community Resources	38
6.10 Typical Characteristics: $V_S = \pm 12\text{ V}$, Low Bias	16	11.3 Trademarks	38
6.11 Typical Characteristics: $V_S = \pm 6\text{ V}$, Full Bias	18	11.4 Electrostatic Discharge Caution	38
6.12 Typical Characteristics: $V_S = \pm 6\text{ V}$, Mid Bias	21	11.5 Glossary	38
6.13 Typical Characteristics: $V_S = \pm 6\text{ V}$, Low Bias	23	12 Mechanical, Packaging, and Orderable Information	38

4 Revision History

Changes from Original (May 2009) to Revision A

Page

• Added <i>Device Information</i> table, <i>Pin Functions</i> table, <i>ESD Ratings</i> table, <i>Recommended Operating Conditions</i> table, <i>Thermal Information</i> table, <i>Timing Requirements</i> table, <i>Overview</i> section, <i>Functional Block Diagram</i> section, <i>Feature Description</i> section, <i>Device Functional Modes</i> section, <i>Application and Implementation</i> section, <i>Power Supply Recommendations</i> section, <i>Layout</i> section, <i>Device and Documentation Support</i> section, and <i>Mechanical, Packaging, and Orderable Information</i> section	1
• Added last Applications bullet	1
• Added last sentence to first paragraph of <i>Description</i> section	1
• Changed QFN to VQFN and TSSOP to HTSSOP throughout document	1
• Deleted <i>Ordering Information</i> table	3
• Deleted <i>Dissipation Ratings</i> table	5
• Changed second paragraph of <i>Distortion Performance</i> section for clarity	26

5 Pin Configuration and Functions

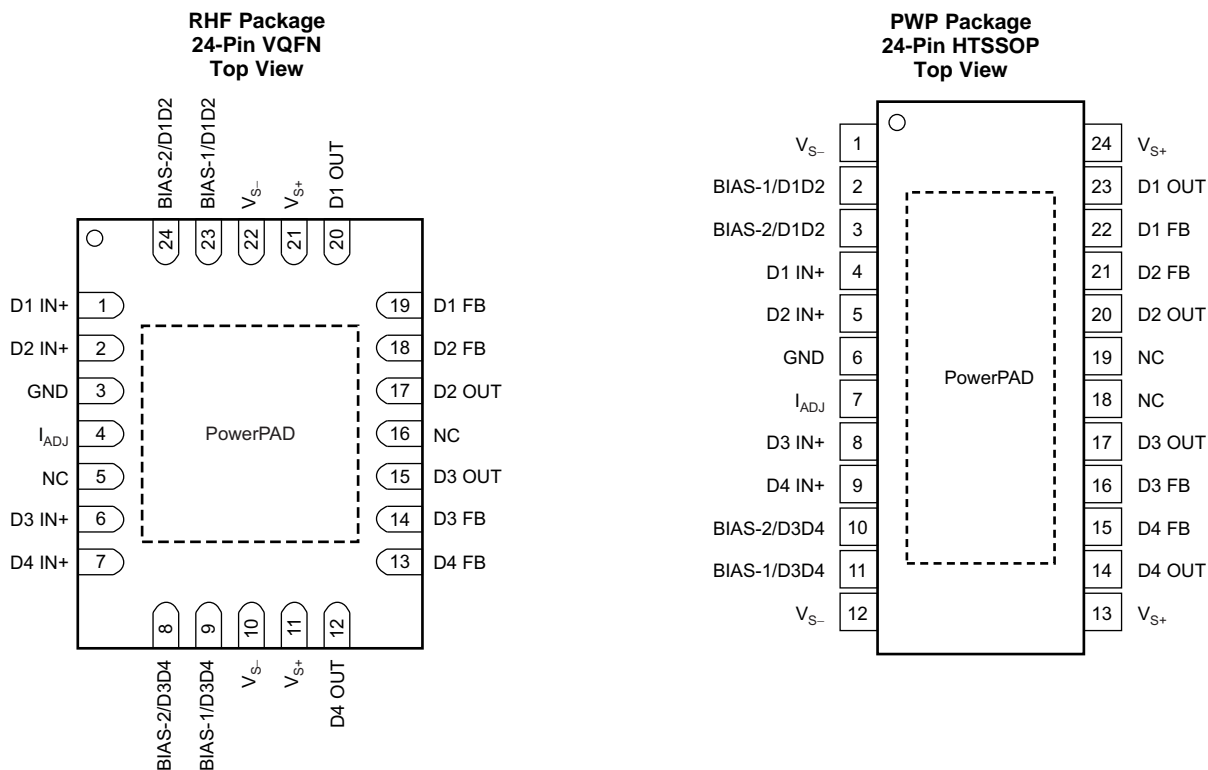

- (1) The PowerPAD is electrically isolated from all other pins and can be connected to any potential voltage range from V_{S-} to V_{S+} . Typically, the PowerPAD is connected to the GND plane because this plane tends to physically be the largest and is able to dissipate the most amount of heat.
- (2) The THS6214 defaults to the shutdown (disable) state if no signal is present on the bias pins.
- (3) The GND pin range is from V_{S-} to $(V_{S+} - 5\text{ V})$.

NOTE: NC = no connection.

Pin Functions⁽¹⁾

NAME	PIN NO.		I/O	DESCRIPTION
	RHF	PWP		
BIAS-1/D1D2	23	2	I	Bias mode parallel control for port A, LSB
BIAS-1/D3D4	9	11	I	Bias mode parallel control for port B, LSB
BIAS-2/D1D2	24	3	I	Bias mode parallel control for port A, MSB
BIAS-2/D3D4	8	10	I	Bias mode parallel control for port B, MSB
D1 FB	19	22	I	Amplifier D1 inverting input
D2 FB	18	21	I	Amplifier D2 inverting input
D3 FB	14	16	I	Amplifier D3 inverting input
D4 FB	13	15	I	Amplifier D4 inverting input
D1 IN+	1	4	I	Amplifier D1 noninverting input
D2 IN+	2	5	I	Amplifier D2 noninverting input
D3 IN+	6	8	I	Amplifier D3 noninverting input
D4 IN+	7	9	I	Amplifier D4 noninverting input
D1 OUT	20	23	O	Amplifier D1 output
D2 OUT	17	20	O	Amplifier D2 output

- (1) The THS6214 defaults to the shutdown (disable) state if no signal is present on the bias pins.

Pin Functions⁽¹⁾ (continued)

NAME	PIN		I/O	DESCRIPTION
	NO.			
	RHF	PWP		
D3 OUT	15	17	O	Amplifier D3 output
D4 OUT	12	14	O	Amplifier D4 output
GND ⁽²⁾	3	6	I/O	Control pin ground reference
I _{ADJ}	4	7	I/O	Bias current adjustment pin
NC	5, 16	18, 19	—	No internal connection
V _{S-}	10, 22	1, 12	I/O	Negative power-supply connection
V _{S+}	11, 21	11, 24	I/O	Positive power-supply connection

(2) The GND pin range is from V_{S-} to (V_{S+} – 5 V).

Table 1. BIAS-1, BIAS-2 Logic Table

BIAS-1	BIAS-0	FUNCTION	DESCRIPTION
0	0	Full bias mode (100%)	Amplifiers on with lowest distortion possible (default state)
1	0	Mid bias mode (75%)	Amplifiers on with power savings and a reduction in distortion performance
0	1	Low bias mode (50%)	Amplifiers on with enhanced power savings and a reduction of overall performance
1	1	Shutdown mode	Amplifiers off and output has high impedance

6 Specifications

6.1 Absolute Maximum Ratings

over operating free-air temperature range (unless otherwise noted)⁽¹⁾

	MIN	MAX	UNIT
Supply voltage, V _{S-} to V _{S+}		28	V
Input voltage, V _I		±V _S	V
Differential input voltage, V _{ID}		±2	V
Output current, I _O	Static dc ⁽²⁾	±500	mA
Continuous power dissipation	See Thermal Information		
Maximum junction temperature, T _J	Under any condition ⁽³⁾	150	°C
	Continuous operation, long-term reliability ⁽⁴⁾ , RHF package only	130	
	Continuous operation, long-term reliability ⁽⁴⁾ , PWP package only	140	
Storage temperature, T _{stg}	–65	150	°C

- (1) Stresses beyond those listed under *Absolute Maximum Ratings* may cause permanent damage to the device. These are stress ratings only, which do not imply functional operation of the device at these or any other conditions beyond those indicated under *Recommended Operating Conditions*. Exposure to absolute-maximum-rated conditions for extended periods may affect device reliability.
- (2) The THS6214 incorporates a PowerPAD on the underside of the chip. This pad functions as a heatsink and must be connected to a thermally dissipating plane for proper power dissipation. Failure to do so may result in exceeding the maximum junction temperature, which can permanently damage the device. See *PowerPAD™ Thermally Enhanced Package (SLMA002)* for more information about using the PowerPAD thermally-enhanced package. Under high-frequency ac operation (greater than 10 kHz), the short-term output current capability is much greater than the continuous dc output current rating. This short-term output current rating is approximately 8.5 times the dc capability, or approximately ±850 mA.
- (3) The absolute maximum junction temperature under any condition is limited by the constraints of the silicon process.
- (4) The absolute maximum junction temperature for continuous operation is limited by the package constraints. Operation above this temperature may result in reduced reliability and/or lifetime of the device.

6.2 ESD Ratings

		VALUE	UNIT
$V_{(ESD)}$	Electrostatic discharge	Human-body model (HBM), per ANSI/ESDA/JEDEC JS-001 ⁽¹⁾	±2000
		Charged-device model (CDM), per JEDEC specification JESD22-C101 ⁽²⁾	±500
		Machine model (MM)	±100

(1) JEDEC document JEP155 states that 500-V HBM allows safe manufacturing with a standard ESD control process.

(2) JEDEC document JEP157 states that 250-V CDM allows safe manufacturing with a standard ESD control process.

6.3 Recommended Operating Conditions

over operating free-air temperature range (unless otherwise noted)

		MIN	NOM	MAX	UNIT
V_S	Supply voltage, V_{S-} to V_{S+}	10		28	V
T_J	Operating junction temperature			130	°C
T_A	Ambient operating air temperature		25	85	°C

6.4 Thermal Information

THERMAL METRIC ⁽¹⁾		THS6214		UNIT
		RHF (VQFN)	PWP (HTSSOP)	
		24 PINS	24 PINS	
$R_{\theta JA}$	Junction-to-ambient thermal resistance	33.2	35.7	°C/W
$R_{\theta JC(top)}$	Junction-to-case (top) thermal resistance	31.7	22.9	°C/W
$R_{\theta JB}$	Junction-to-board thermal resistance	11.3	10.1	°C/W
Ψ_{JT}	Junction-to-top characterization parameter	0.4	0.4	°C/W
Ψ_{JB}	Junction-to-board characterization parameter	11.3	10.3	°C/W
$R_{\theta JC(bot)}$	Junction-to-case (bottom) thermal resistance	3.9	1.7	°C/W

(1) For more information about traditional and new thermal metrics, see the [Semiconductor and IC Package Thermal Metrics](#) application report.

6.5 Electrical Characteristics: $V_S = \pm 12\text{ V}$

at $T_A = 25^\circ\text{C}$, $G_{\text{DIFF}} = 10\text{ V/V}$ with $R_L = 100\text{-}\Omega$ differential load, $R_{\text{ADJ}} = 0\ \Omega$, active impedance circuit configuration, and full bias (unless otherwise noted); each port is independently tested

PARAMETER	TEST CONDITIONS	MIN	TYP	MAX	UNIT	TEST LEVEL ⁽¹⁾		
AC PERFORMANCE								
Small-signal bandwidth, -3 dB	$G_{\text{DIFF}} = 5\text{ V/V}$, $R_F = 1.5\text{ k}\Omega$, $V_O = 2\text{ V}_{\text{PP}}$		160		MHz	C		
	$G_{\text{DIFF}} = 10\text{ V/V}$, $R_F = 1.5\text{ k}\Omega$, $V_O = 2\text{ V}_{\text{PP}}$	120	150			B		
	Over -40°C to $+85^\circ\text{C}$ temperature range	100						
0.1-dB bandwidth flatness	$G_{\text{DIFF}} = 10\text{ V/V}$, $R_F = 1.24\text{ k}\Omega$		114		MHz	C		
Large-signal bandwidth	$G_{\text{DIFF}} = 10\text{ V/V}$, $R_F = 1.24\text{ k}\Omega$, $V_O = 20\text{ V}_{\text{PP}}$		120		MHz	C		
Slew rate (10% to 90% level)	$G_{\text{DIFF}} = 10\text{ V/V}$, $V_O = 20\text{-V}$ step, differential	3200	3800		V/ μs	B		
	$T_A = -40^\circ\text{C}$ to $+85^\circ\text{C}$	3000				B		
Rise and fall time	$G_{\text{DIFF}} = 10\text{ V/V}$, $V_O = 2\text{ V}_{\text{PP}}$		5		ns	C		
2nd-order harmonic distortion	$G_{\text{DIFF}} = 10\text{ V/V}$, $V_O = 2\text{ V}_{\text{PP}}$, $R_L = 100\text{-}\Omega$ differential	Full bias, $f = 1\text{ MHz}$		-100	-95	dBc	B	
		$T_A = -40^\circ\text{C}$ to $+85^\circ\text{C}$					-90	B
		Low bias, $f = 1\text{ MHz}$		-96				C
		Full bias, $f = 10\text{ MHz}$		-75	-70			B
		$T_A = -40^\circ\text{C}$ to $+85^\circ\text{C}$					-65	B
		Low bias, $f = 10\text{ MHz}$		-72				C
3rd-order harmonic distortion	$G_{\text{DIFF}} = 10\text{ V/V}$, $V_O = 2\text{ V}_{\text{PP}}$, $R_L = 100\text{-}\Omega$ differential	Full bias, $f = 1\text{ MHz}$		-89	-85	dBc	B	
		$T_A = -40^\circ\text{C}$ to $+85^\circ\text{C}$					-80	B
		Low bias, $f = 1\text{ MHz}$		-85				C
		Full bias, $f = 10\text{ MHz}$		-73	-65			B
		$T_A = -40^\circ\text{C}$ to $+85^\circ\text{C}$					-53	B
		Low bias, $f = 10\text{ MHz}$		-58				C
Differential input voltage noise	$f = 1\text{ MHz}$, input-referred		2.7	3.2	nV/ $\sqrt{\text{Hz}}$	B		
	$T_A = -40^\circ\text{C}$ to $+85^\circ\text{C}$			3.5		B		
Differential noninverting current noise	$f = 1\text{ MHz}$		1.2	1.4	pA/ $\sqrt{\text{Hz}}$	B		
	$T_A = -40^\circ\text{C}$ to $+85^\circ\text{C}$			1.6		B		
Differential inverting current noise	$f = 1\text{ MHz}$		17	20	pA/ $\sqrt{\text{Hz}}$	B		
	$T_A = -40^\circ\text{C}$ to $+85^\circ\text{C}$			24		B		
DC PERFORMANCE								
Open-loop transimpedance gain	$R_L = 100\ \Omega$	330 ⁽²⁾	700		k Ω	A		
		300				B		
Input offset voltage			± 15	± 50 ⁽²⁾	mV	A		
	$T_A = -40^\circ\text{C}$ to $+85^\circ\text{C}$			± 60		B		
Input offset voltage drift	$T_A = -40^\circ\text{C}$ to $+85^\circ\text{C}$			± 155	$\mu\text{V}/^\circ\text{C}$	B		
Input offset voltage matching			± 0.5	± 5 ⁽²⁾	mV	A		
	$T_A = -40^\circ\text{C}$ to $+85^\circ\text{C}$			± 7		B		
Noninverting input bias current			± 1	± 3.5 ⁽²⁾	μA	A		
	$T_A = -40^\circ\text{C}$ to $+85^\circ\text{C}$			± 5.5		B		
Noninverting input bias current drift	$T_A = -40^\circ\text{C}$ to $+85^\circ\text{C}$			± 30 ⁽²⁾	nA/ $^\circ\text{C}$	B		
Inverting input bias current			± 8	± 45 ⁽²⁾	μA	A		
	$T_A = -40^\circ\text{C}$ to $+85^\circ\text{C}$			± 55		B		
Inverting input bias current drift	$T_A = -40^\circ\text{C}$ to $+85^\circ\text{C}$			± 154	nA/ $^\circ\text{C}$	B		
Inverting input bias current matching			± 8	± 30 ⁽²⁾	μA	A		
	$T_A = -40^\circ\text{C}$ to $+85^\circ\text{C}$			± 40		B		

(1) Test levels: (A) 100% tested at 25°C . Overtemperature limits set by characterization and simulation. (B) Limits set by characterization and simulation. (C) Typical value only for information.

(2) This specification is 100% tested at 25°C .

Electrical Characteristics: $V_S = \pm 12\text{ V}$ (continued)

at $T_A = 25^\circ\text{C}$, $G_{\text{DIFF}} = 10\text{ V/V}$ with $R_L = 100\text{-}\Omega$ differential load, $R_{\text{ADJ}} = 0\ \Omega$, active impedance circuit configuration, and full bias (unless otherwise noted); each port is independently tested

PARAMETER	TEST CONDITIONS	MIN	TYP	MAX	UNIT	TEST LEVEL ⁽¹⁾
INPUT CHARACTERISTICS						
Common-mode input range	Each input	$\pm 9^{(2)}$	± 9.5		V	A
	$T_A = -40^\circ\text{C}$ to $+85^\circ\text{C}$	± 8.6				B
Common-mode rejection ratio	Each input	$53^{(2)}$	65		dB	A
	$T_A = -40^\circ\text{C}$ to $+85^\circ\text{C}$	49				B
Noninverting input resistance			$500\ \parallel\ 2$		k Ω pF	C
Inverting input resistance			50		Ω	C
OUTPUT CHARACTERISTICS⁽³⁾						
Output voltage swing	$R_L = 100\ \Omega$, each output		± 10.9		V	C
	$R_L = 50\ \Omega$, each output	$\pm 10.6^{(2)}$	± 10.8			A
	$T_A = -40^\circ\text{C}$ to $+85^\circ\text{C}$	± 10.4				B
	$R_L = 25\ \Omega$, each output	$\pm 10.2^{(2)}$	± 10.4			A
	$T_A = -40^\circ\text{C}$ to $+85^\circ\text{C}$	± 10				B
Output current (sourcing and sinking)	$R_L = 25\ \Omega$, based on V_O tests	$\pm 408^{(2)}$	± 416		mA	A
	$T_A = -40^\circ\text{C}$ to $+85^\circ\text{C}$	± 400				B
Short-circuit output current			1		A	C
Output impedance	$f = 1\text{ MHz}$, differential		0.2		Ω	C
Crosstalk	$f = 1\text{ MHz}$, $V_O = 2\text{ V}_{\text{PP}}$, port 1 to port 2		-90		dB	C
POWER SUPPLY						
Operating voltage		$\pm 5^{(2)}$	± 12	$\pm 14^{(2)}$	V	A
	$T_A = -40^\circ\text{C}$ to $+85^\circ\text{C}$	± 5		± 14		C
I_{S+} quiescent current	Per port, full bias (BIAS-1 = 0, BIAS-2 = 0)	$19.5^{(2)}$	21	$22.5^{(2)}$	mA	A
	$T_A = -40^\circ\text{C}$ to $+85^\circ\text{C}$	17		24		B
	Per port, mid bias (BIAS-1 = 1, BIAS-2 = 0)	$15^{(2)}$	16.2	$17.4^{(2)}$		A
	$T_A = -40^\circ\text{C}$ to $+85^\circ\text{C}$	12.8		18.6		B
	Per port, low bias (BIAS-1 = 0, BIAS-2 = 1)	$10^{(2)}$	11.2	$12.4^{(2)}$		A
	$T_A = -40^\circ\text{C}$ to $+85^\circ\text{C}$	8.1		13.2		B
	Per port, bias off (BIAS-1 = 1, BIAS-2 = 1)		0.4	$0.8^{(2)}$		A
	$T_A = -40^\circ\text{C}$ to $+85^\circ\text{C}$			1		B
I_{S-} quiescent current	Per port, full bias (BIAS-1 = 0, BIAS-2 = 0)	$18.5^{(2)}$	20	$21.5^{(2)}$	mA	A
	$T_A = -40^\circ\text{C}$ to $+85^\circ\text{C}$	16		23		B
	Per port, mid bias (BIAS-1 = 1, BIAS-2 = 0)	$14^{(2)}$	15.2	$16.4^{(2)}$		A
	$T_A = -40^\circ\text{C}$ to $+85^\circ\text{C}$	11.8		17.6		B
	Per port, low bias (BIAS-1 = 0, BIAS-2 = 1)	$9^{(2)}$	10.2	$11.6^{(2)}$		A
	$T_A = -40^\circ\text{C}$ to $+85^\circ\text{C}$	7.1		11.4		B
	Per port, bias off (BIAS-1 = 1, BIAS-2 = 1)		0.1	$0.3^{(2)}$		A
	$T_A = -40^\circ\text{C}$ to $+85^\circ\text{C}$			0.8		B
Current through GND pin	Per port, full bias (BIAS-1 = 0, BIAS-2 = 0)		1		mA	C
+PSRR Positive power-supply rejection ratio	Differential	$54^{(2)}$	66		dB	A
	$T_A = -40^\circ\text{C}$ to $+85^\circ\text{C}$	52				B
-PSRR Negative power-supply rejection ratio	Differential	$52^{(2)}$	65		dB	A
	$T_A = -40^\circ\text{C}$ to $+85^\circ\text{C}$	50				B

(3) Test circuit is shown in [Figure 1](#).

Electrical Characteristics: $V_S = \pm 12\text{ V}$ (continued)

at $T_A = 25^\circ\text{C}$, $G_{\text{DIFF}} = 10\text{ V/V}$ with $R_L = 100\text{-}\Omega$ differential load, $R_{\text{ADJ}} = 0\ \Omega$, active impedance circuit configuration, and full bias (unless otherwise noted); each port is independently tested

PARAMETER	TEST CONDITIONS	MIN	TYP	MAX	UNIT	TEST LEVEL ⁽¹⁾
LOGIC						
Bias control pin logic threshold	Logic 1, with respect to GND ⁽⁴⁾ , $T_A = -40^\circ\text{C}$ to $+85^\circ\text{C}$	1.9			V	B
	Logic 0, with respect to GND ⁽⁴⁾ , $T_A = -40^\circ\text{C}$ to $+85^\circ\text{C}$			0.8		B
Bias pin quiescent current	BIAS-1, BIAS-2 = 0.5 V (logic 0)		20	30 ⁽²⁾	μA	A
	$T_A = -40^\circ\text{C}$ to $+85^\circ\text{C}$			35		B
	BIAS-1, BIAS-2 = 3.3 V (logic 1)		0.3	1 ⁽²⁾		A
	$T_A = -40^\circ\text{C}$ to $+85^\circ\text{C}$			1.2		B
Bias pin input impedance			50		k Ω	C
Amplifier output impedance	Off bias (BIAS-1 = 1, BIAS-2 = 1)		10 5		k Ω pF	C

(4) The GND pin usable range is from V_{S-} to $(V_{S+} - 5\text{ V})$.

6.6 Electrical Characteristics: $V_S = \pm 6\text{ V}$

at $T_A = 25^\circ\text{C}$, $G_{\text{DIFF}} = 5\text{ V/V}$ with $R_L = 100\text{-}\Omega$ differential load, $R_{\text{ADJ}} = 0\ \Omega$, active impedance circuit configuration, and full bias (unless otherwise noted); each port is independently tested

PARAMETER	TEST CONDITIONS	MIN	TYP	MAX	UNIT	TEST LEVEL ⁽¹⁾		
AC PERFORMANCE								
Small-signal bandwidth, -3 dB	$G_{\text{DIFF}} = 5\text{ V/V}$, $R_F = 1.5\text{ k}\Omega$, $V_O = 2\text{ V}_{\text{PP}}$		140		MHz	C		
	$G_{\text{DIFF}} = 10\text{ V/V}$, $R_F = 1.5\text{ k}\Omega$, $V_O = 2\text{ V}_{\text{PP}}$	110	140			B		
	Over -40°C to $+85^\circ\text{C}$ temperature range	95						
0.1-dB bandwidth flatness	$G_{\text{DIFF}} = 10\text{ V/V}$, $R_F = 1.24\text{ k}\Omega$		100		MHz	C		
Large-signal bandwidth	$G_{\text{DIFF}} = 10\text{ V/V}$, $R_F = 1.24\text{ k}\Omega$, $V_O = 20\text{ V}_{\text{PP}}$		120		MHz	C		
Slew rate (10% to 90% level)	$G_{\text{DIFF}} = 10\text{ V/V}$, $V_O = 20\text{-V}$ step, differential	1200	1600		V/ μs	B		
	$T_A = -40^\circ\text{C}$ to $+85^\circ\text{C}$	1000				B		
Rise and fall time	$G_{\text{DIFF}} = 10\text{ V/V}$, $V_O = 2\text{ V}_{\text{PP}}$		5		ns	C		
2nd-order harmonic distortion	$G_{\text{DIFF}} = 10\text{ V/V}$, $V_O = 2\text{ V}_{\text{PP}}$, $R_L = 100\text{-}\Omega$ differential	Full bias		-98	-92	dBc	B	
		$T_A = -40^\circ\text{C}$ to $+85^\circ\text{C}$					-87	B
		Low bias		-93				C
		Full bias		-80	-75			B
		$T_A = -40^\circ\text{C}$ to $+85^\circ\text{C}$					-68	B
		Low bias		-74				C
3rd-order harmonic distortion	$G_{\text{DIFF}} = 10\text{ V/V}$, $V_O = 2\text{ V}_{\text{PP}}$, $R_L = 100\text{-}\Omega$ differential	Full bias		-93	-84	dBc	B	
		$T_A = -40^\circ\text{C}$ to $+85^\circ\text{C}$					-79	B
		Low bias		-89				C
		Full bias		-66	-60			B
		$T_A = -40^\circ\text{C}$ to $+85^\circ\text{C}$					-54	B
		Low bias		-55				C
Differential input voltage noise	$f = 1\text{ MHz}$, input-referred		2.5	3.0	nV/ $\sqrt{\text{Hz}}$	B		
	$T_A = -40^\circ\text{C}$ to $+85^\circ\text{C}$			3.3		B		
Differential noninverting current noise	$f = 1\text{ MHz}$		1.2	1.4	pA/ $\sqrt{\text{Hz}}$	B		
	$T_A = -40^\circ\text{C}$ to $+85^\circ\text{C}$			1.6		B		
Differential inverting current noise	$f = 1\text{ MHz}$		17	20	pA/ $\sqrt{\text{Hz}}$	B		
	$T_A = -40^\circ\text{C}$ to $+85^\circ\text{C}$			24		B		

(1) Test levels: (A) 100% tested at 25°C . Overtemperature limits set by characterization and simulation. (B) Limits set by characterization and simulation. (C) Typical value only for information.

Electrical Characteristics: $V_S = \pm 6\text{ V}$ (continued)

at $T_A = 25^\circ\text{C}$, $G_{\text{DIFF}} = 5\text{ V/V}$ with $R_L = 100\text{-}\Omega$ differential load, $R_{\text{ADJ}} = 0\ \Omega$, active impedance circuit configuration, and full bias (unless otherwise noted); each port is independently tested

PARAMETER	TEST CONDITIONS	MIN	TYP	MAX	UNIT	TEST LEVEL ⁽¹⁾
DC PERFORMANCE						
Open-loop transimpedance gain	$R_L = 100\ \Omega$	330 ⁽²⁾	650		k Ω	A
	$T_A = -40^\circ\text{C to } +85^\circ\text{C}$	300				B
Input offset voltage			± 10	± 45 ⁽²⁾	mV	A
	$T_A = -40^\circ\text{C to } +85^\circ\text{C}$			± 55		B
Input offset voltage drift	$T_A = -40^\circ\text{C to } +85^\circ\text{C}$			± 155	$\mu\text{V}/^\circ\text{C}$	B
Input offset voltage matching	Channels 1 to 2 and 3 to 4 only		± 0.5	± 5 ⁽²⁾	mV	A
	$T_A = -40^\circ\text{C to } +85^\circ\text{C}$			± 7		B
Noninverting input bias current			± 1	± 3.5 ⁽²⁾	μA	A
	$T_A = -40^\circ\text{C to } +85^\circ\text{C}$			± 5.5		B
Noninverting input bias current drift	$T_A = -40^\circ\text{C to } +85^\circ\text{C}$			± 30 ⁽²⁾	nA/ $^\circ\text{C}$	B
Inverting input bias current			± 8	± 45 ⁽²⁾	μA	A
	$T_A = -40^\circ\text{C to } +85^\circ\text{C}$			± 55		B
Inverting input bias current drift	$T_A = -40^\circ\text{C to } +85^\circ\text{C}$			± 135	nA/ $^\circ\text{C}$	B
Inverting input bias current matching			± 8	± 30 ⁽²⁾	μA	A
	$T_A = -40^\circ\text{C to } +85^\circ\text{C}$			± 40		B
INPUT CHARACTERISTICS						
Common-mode input range	Each input	± 2.9 ⁽²⁾	± 3.0		V	A
	$T_A = -40^\circ\text{C to } +85^\circ\text{C}$	± 2.7				B
Common-mode rejection ratio	Each input	51 ⁽²⁾	62		dB	A
	$T_A = -40^\circ\text{C to } +85^\circ\text{C}$	47				B
Noninverting input resistance			500 2		k Ω pF	C
Inverting input resistance			55		Ω	C
OUTPUT CHARACTERISTICS⁽³⁾						
Output voltage swing	$R_L = 100\ \Omega$, each output		± 4.9		V	C
	$R_L = 50\ \Omega$, each output	± 4.75 ⁽²⁾	± 4.9			A
	$T_A = -40^\circ\text{C to } +85^\circ\text{C}$	± 4.6				B
	$R_L = 25\ \Omega$, each output	± 4.55 ⁽²⁾	± 4.7			A
	$T_A = -40^\circ\text{C to } +85^\circ\text{C}$	± 4.4				B
Output current (sourcing and sinking)	$R_L = 25\ \Omega$, based on V_O tests	± 182 ⁽²⁾	± 188		mA	A
	$T_A = -40^\circ\text{C to } +85^\circ\text{C}$	± 176				B
Short-circuit output current			± 1		A	C
Output impedance	$f = 1\ \text{MHz}$, differential		0.2		Ω	C
Crosstalk	$f = 1\ \text{MHz}$, $V_O = 2\ V_{\text{PP}}$, port 1 to port 2		-90		dB	C

(2) This specification is 100% tested at 25°C .

(3) Test circuit is shown in [Figure 1](#).

Electrical Characteristics: $V_S = \pm 6\text{ V}$ (continued)

 at $T_A = 25^\circ\text{C}$, $G_{\text{DIFF}} = 5\text{ V/V}$ with $R_L = 100\text{-}\Omega$ differential load, $R_{\text{ADJ}} = 0\ \Omega$, active impedance circuit configuration, and full bias (unless otherwise noted); each port is independently tested

PARAMETER	TEST CONDITIONS	MIN	TYP	MAX	UNIT	TEST LEVEL ⁽¹⁾
POWER SUPPLY						
Operating voltage		$\pm 5^{(2)}$	± 6	$\pm 14^{(2)}$	V	A
	$T_A = -40^\circ\text{C}$ to $+85^\circ\text{C}$	± 5		± 14		C
I_{S+} quiescent current	Per port, full bias (BIAS-1 = 0, BIAS-2 = 0)	$13^{(2)}$	17	$21^{(2)}$	mA	A
	$T_A = -40^\circ\text{C}$ to $+85^\circ\text{C}$	10		22		B
	Per port, mid bias (BIAS-1 = 1, BIAS-2 = 0)	$10.2^{(2)}$	13.2	$16.2^{(2)}$		A
	$T_A = -40^\circ\text{C}$ to $+85^\circ\text{C}$	9.3		16.4		B
	Per port, low bias (BIAS-1 = 0, BIAS-2 = 1)	$7.4^{(2)}$	9.4	$11.4^{(2)}$		A
	$T_A = -40^\circ\text{C}$ to $+85^\circ\text{C}$	6.7		11.6		B
	Per port, bias off (BIAS-1 = 1, BIAS-2 = 1)		0.5	$0.8^{(2)}$		A
	$T_A = -40^\circ\text{C}$ to $+85^\circ\text{C}$			0.9		B
I_{S-} quiescent current	Per port, full bias (BIAS-1 = 0, BIAS-2 = 0)	$12^{(2)}$	16	$20^{(2)}$	mA	A
	$T_A = -40^\circ\text{C}$ to $+85^\circ\text{C}$	9		21		B
	Per port, mid bias (BIAS-1 = 1, BIAS-2 = 0)	$9.2^{(2)}$	12.2	$15.2^{(2)}$		A
	$T_A = -40^\circ\text{C}$ to $+85^\circ\text{C}$	8.3		15.4		B
	Per port, low bias (BIAS-1 = 0, BIAS-2 = 1)	$6.4^{(2)}$	8.4	$10.4^{(2)}$		A
	$T_A = -40^\circ\text{C}$ to $+85^\circ\text{C}$	5.7		10.6		B
	Per port, bias off (BIAS-1 = 1, BIAS-2 = 1)		0.1	$0.3^{(2)}$		A
	$T_A = -40^\circ\text{C}$ to $+85^\circ\text{C}$			0.5		B
Current through GND pin	Per port, full bias (BIAS-1 = 0, BIAS-2 = 0)		1		mA	C
+PSRR Positive power-supply rejection ratio	Differential	$54^{(2)}$	64		dB	A
	$T_A = -40^\circ\text{C}$ to $+85^\circ\text{C}$	52				B
-PSRR Negative power-supply rejection ratio	Differential	$52^{(2)}$	63		dB	A
	$T_A = -40^\circ\text{C}$ to $+85^\circ\text{C}$	50				B
LOGIC						
Bias control pin logic threshold	Logic 1, with respect to GND ⁽⁴⁾ , $T_A = -40^\circ\text{C}$ to $+85^\circ\text{C}$	1.9			V	B
	Logic 0, with respect to GND ⁽⁴⁾ , $T_A = -40^\circ\text{C}$ to $+85^\circ\text{C}$			0.8		B
Bias pin quiescent current	BIAS-1, BIAS-2 = 0.5 V (logic 0)		20	$30^{(2)}$	μA	A
	$T_A = -40^\circ\text{C}$ to $+85^\circ\text{C}$			35		B
	BIAS-1, BIAS-2 = 3.3 V (logic 1)		0.3	$1^{(2)}$		A
	$T_A = -40^\circ\text{C}$ to $+85^\circ\text{C}$			1.2		B
Bias pin input impedance			50		k Ω	C
Amplifier output impedance	Off bias (BIAS-1 = 1, BIAS-2 = 1)		$10 \parallel 5$		k $\Omega \parallel \text{pF}$	C

 (4) The GND pin usable range is from V_{S-} to $(V_{S+} - 5\text{ V})$.

6.7 Timing Requirements

		MIN	NOM	MAX	UNIT
t_{ON}	Turn-on time delay: time for I_S to reach 50% of final value		1		μs
t_{OFF}	Turn-off time delay: time for I_S to reach 50% of final value		1		μs

6.8 Typical Characteristics: $V_S = \pm 12\text{ V}$, Full Bias

at $T_A = 25^\circ\text{C}$, $G_{\text{DIFF}} = 10\text{ V/V}$, $G_{\text{CM}} = 1\text{ V/V}$, $R_{\text{ADJ}} = 0\ \Omega$, $R_F = 1.24\text{ k}\Omega$, and $R_L = 100\ \Omega$ (unless otherwise noted)

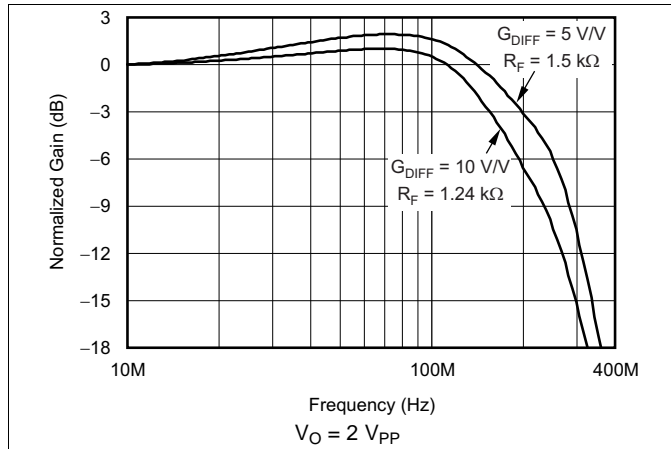

Figure 1. Small-Signal Frequency Response

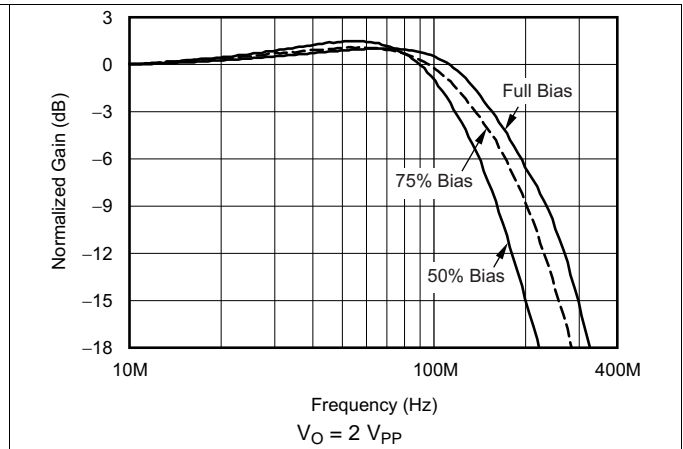

Figure 2. Small-Signal Frequency Response vs Bias Mode

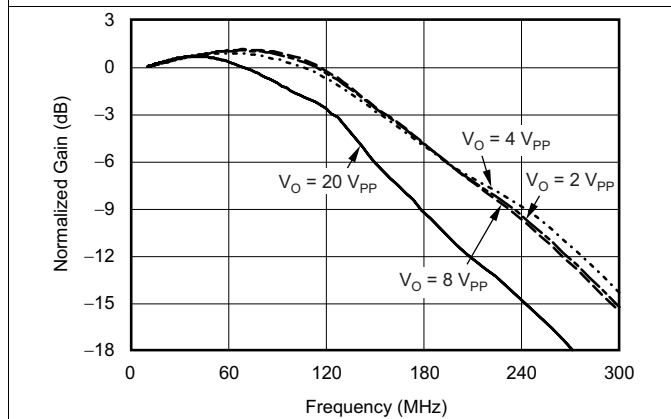

Figure 3. Large-Signal Frequency Response

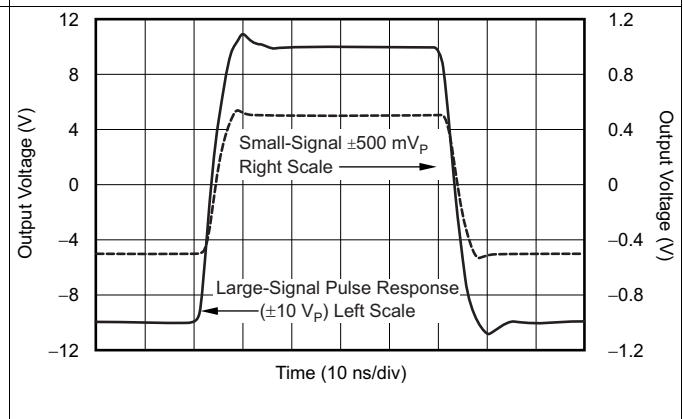

Figure 4. Pulse Response

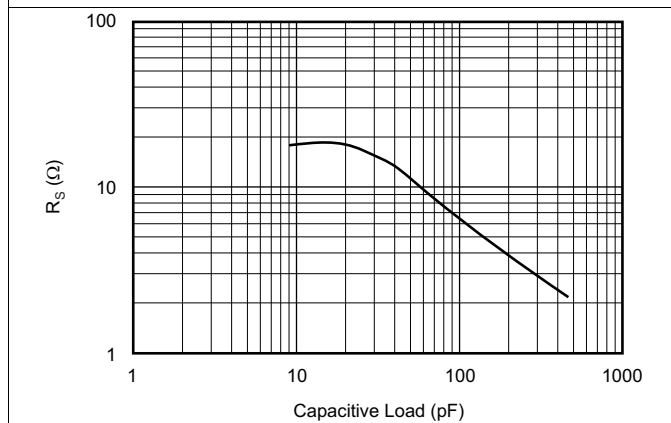

Figure 5. Recommended R_S vs Capacitive Load

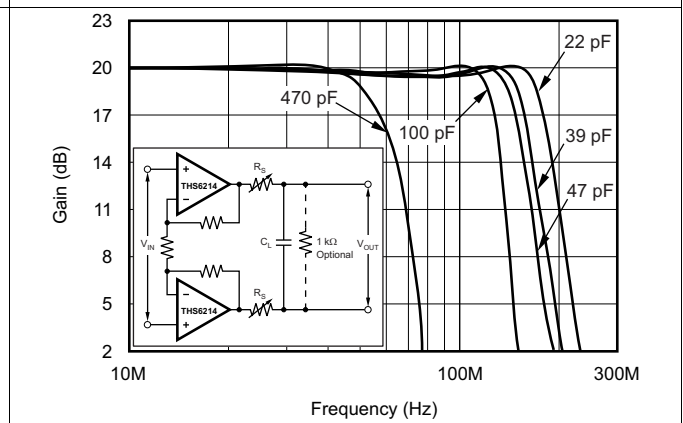

Figure 6. Frequency Response vs Capacitive Load

Typical Characteristics: $V_S = \pm 12\text{ V}$, Full Bias (continued)

at $T_A = 25^\circ\text{C}$, $G_{DIFF} = 10\text{ V/V}$, $G_{CM} = 1\text{ V/V}$, $R_{ADJ} = 0\ \Omega$, $R_F = 1.24\text{ k}\Omega$, and $R_L = 100\ \Omega$ (unless otherwise noted)

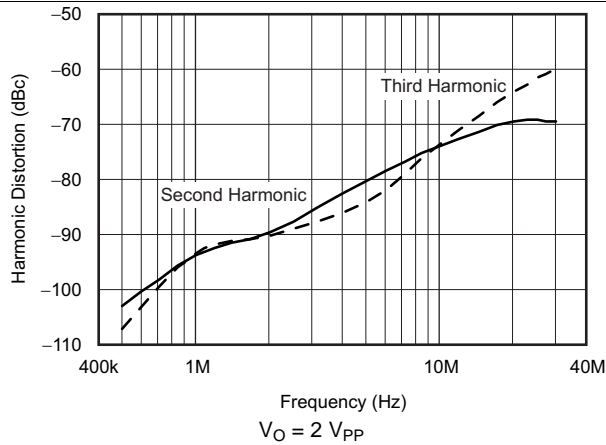

Figure 7. Harmonic Distortion vs Frequency

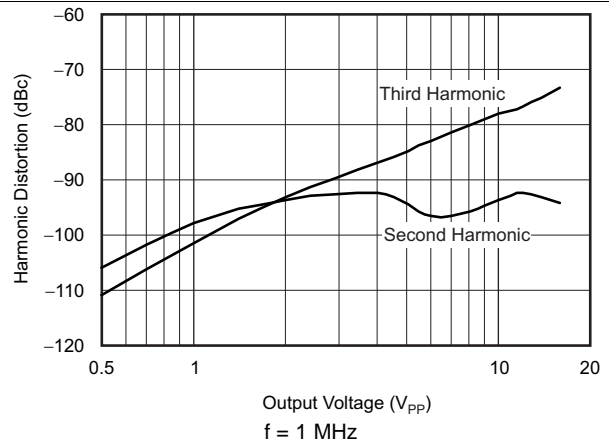

Figure 8. Harmonic Distortion vs Output Voltage

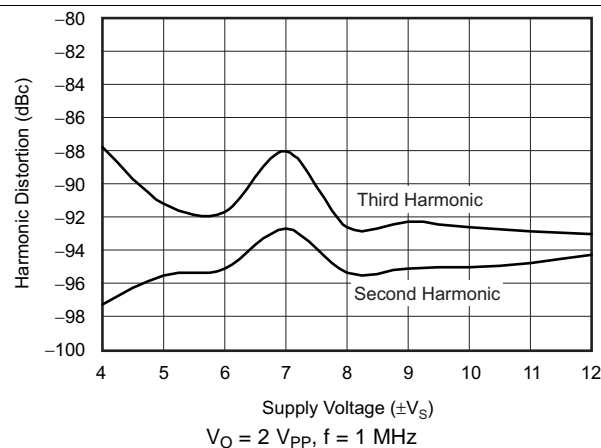

Figure 9. Harmonic Distortion vs Supply Voltage

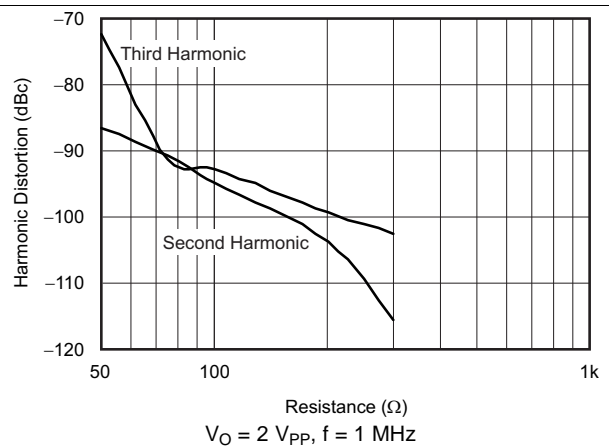

Figure 10. Harmonic Distortion vs Load Resistance

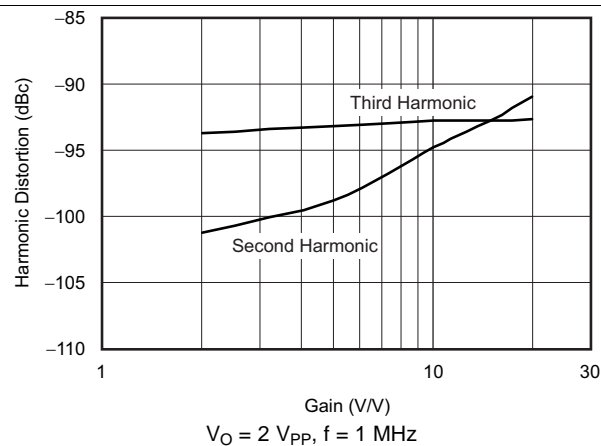

Figure 11. Harmonic Distortion vs Noninverting Gain

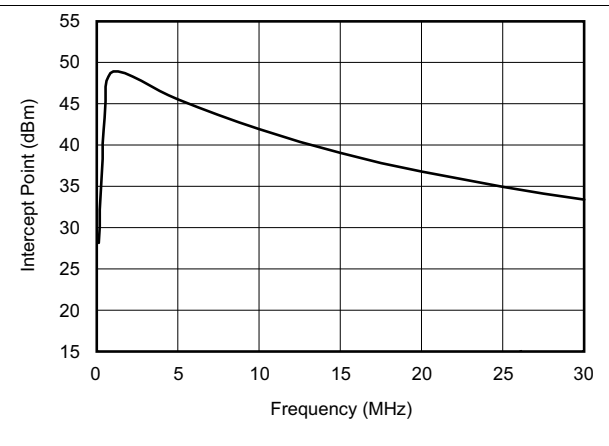

Figure 12. Two-Tone, Third-Order Intermodulation Intercept

Typical Characteristics: $V_S = \pm 12\text{ V}$, Full Bias (continued)

at $T_A = 25^\circ\text{C}$, $G_{DIFF} = 10\text{ V/V}$, $G_{CM} = 1\text{ V/V}$, $R_{ADJ} = 0\ \Omega$, $R_F = 1.24\text{ k}\Omega$, and $R_L = 100\ \Omega$ (unless otherwise noted)

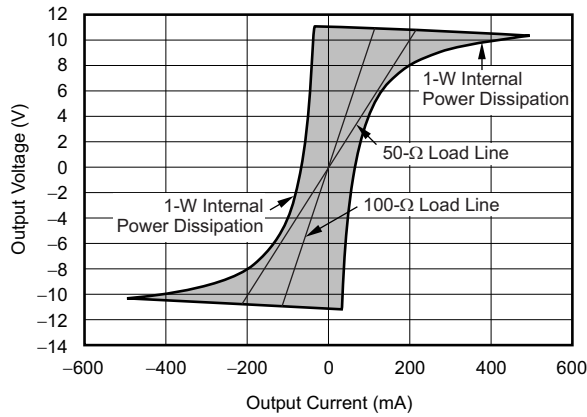

Figure 13. Output Voltage and Current Limitations

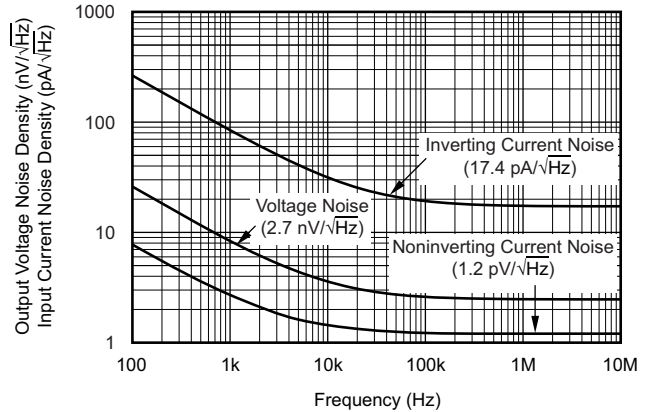

Figure 14. Input Voltage and Current Noise Density

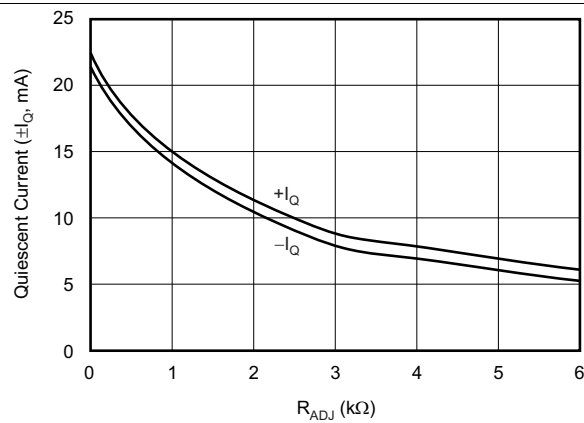

Figure 15. Quiescent Current for Full Bias Setting vs R_{ADJ}

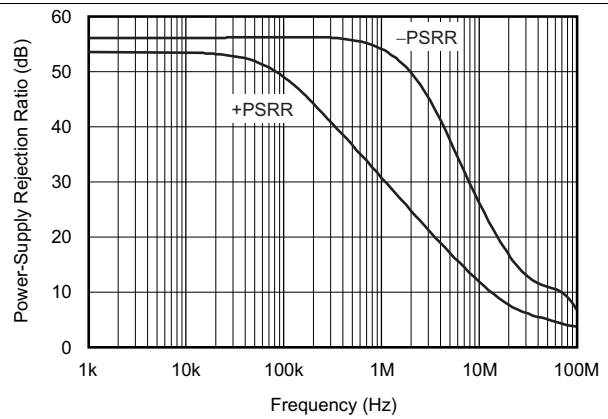

Figure 16. PSRR vs Frequency

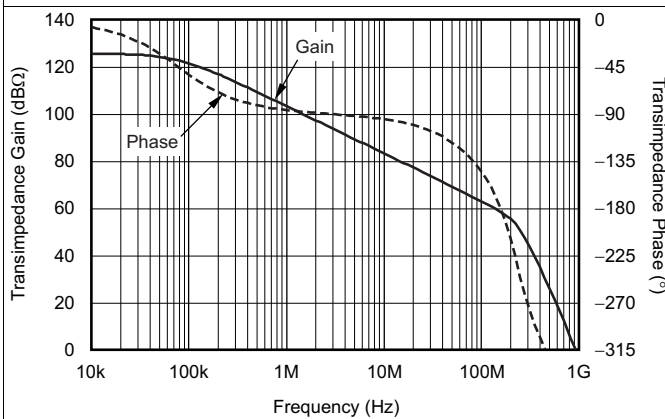

Figure 17. Open-Loop Gain and Phase

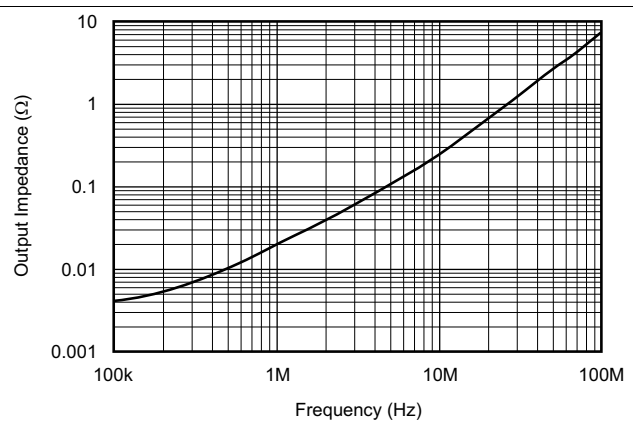

Figure 18. Closed-Loop Output Impedance

6.9 Typical Characteristics: $V_S = \pm 12\text{ V}$, Mid Bias

at $T_A = 25^\circ\text{C}$, $G_{\text{DIFF}} = 10\text{ V/V}$, $G_{\text{CM}} = 1\text{ V/V}$, $R_{\text{ADJ}} = 0\ \Omega$, $R_F = 1.24\text{ k}\Omega$, and $R_L = 100\ \Omega$ (unless otherwise noted)

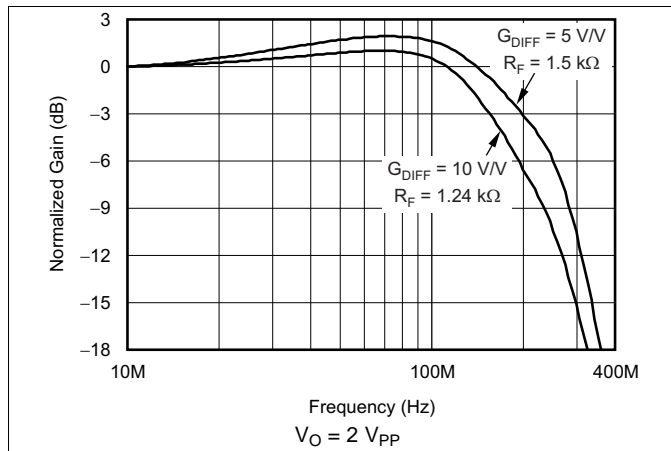

Figure 19. Small-Signal Frequency Response

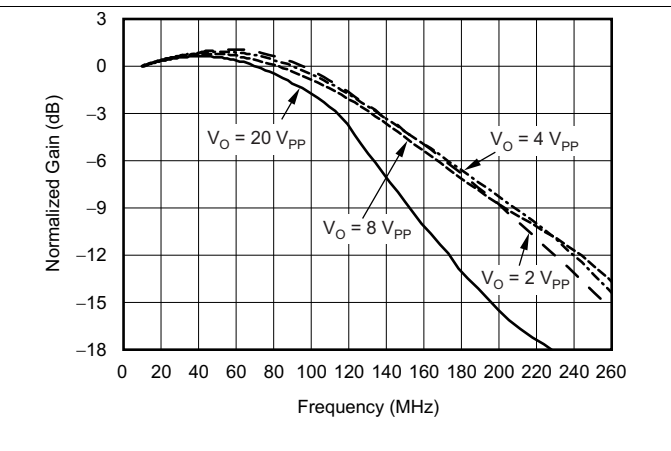

Figure 20. Large-Signal Frequency Response

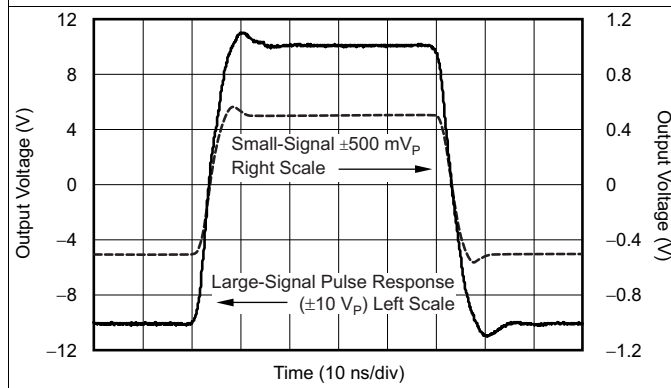

Figure 21. Pulse Response

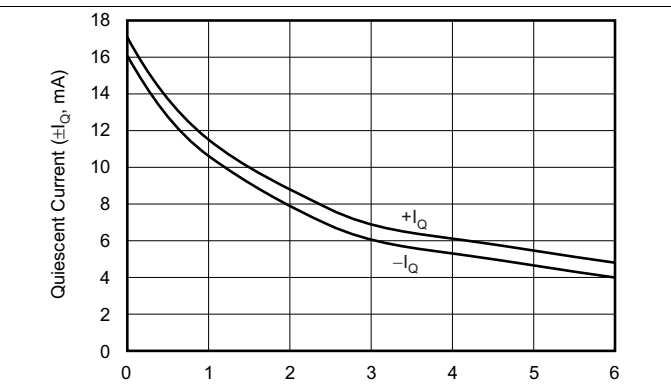

Figure 22. Quiescent Current for Mid Bias Setting vs R_{ADJ}

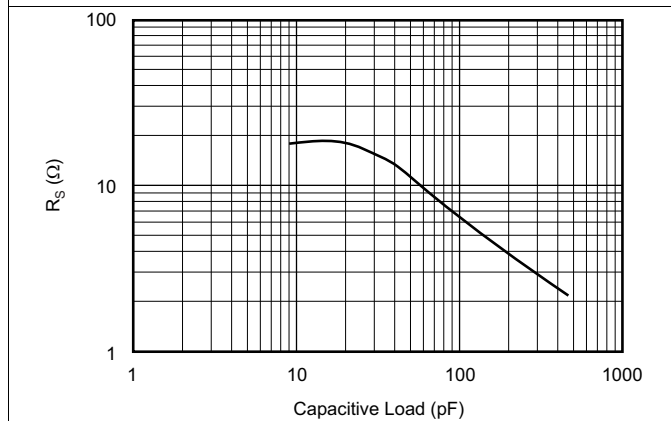

Figure 23. Recommended R_S vs Capacitive Load

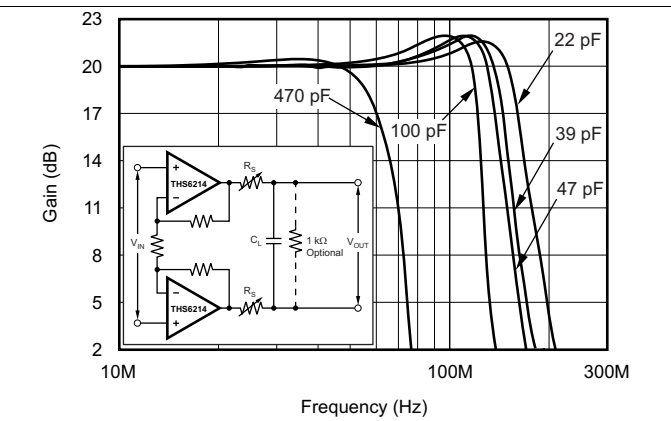

Figure 24. Frequency Response vs Capacitive Load

Typical Characteristics: $V_S = \pm 12\text{ V}$, Mid Bias (continued)

at $T_A = 25^\circ\text{C}$, $G_{DIFF} = 10\text{ V/V}$, $G_{CM} = 1\text{ V/V}$, $R_{ADJ} = 0\ \Omega$, $R_F = 1.24\text{ k}\Omega$, and $R_L = 100\ \Omega$ (unless otherwise noted)

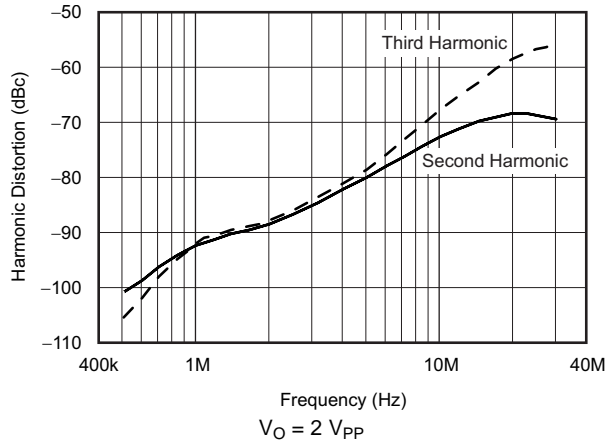

Figure 25. Harmonic Distortion vs Frequency

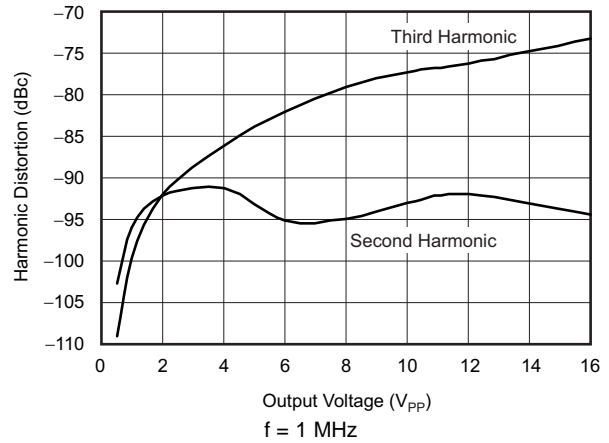

Figure 26. Harmonic Distortion vs Output Voltage

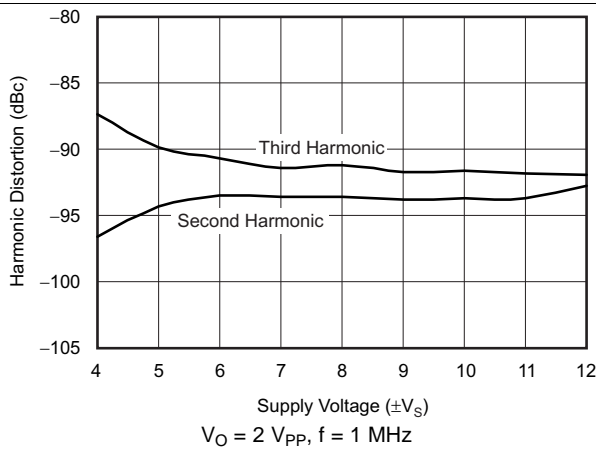

Figure 27. Harmonic Distortion vs Supply Voltage

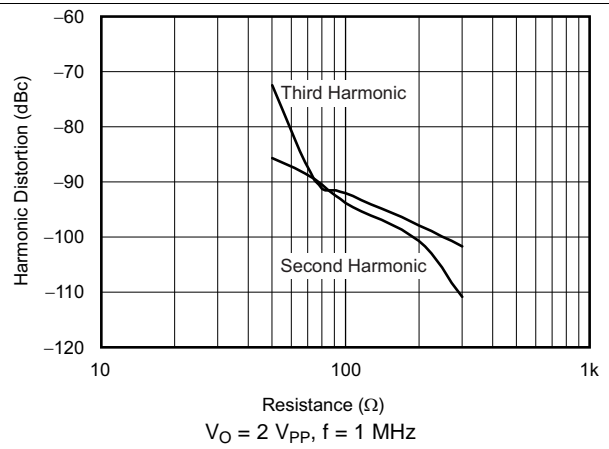

Figure 28. Harmonic Distortion vs Load Resistance

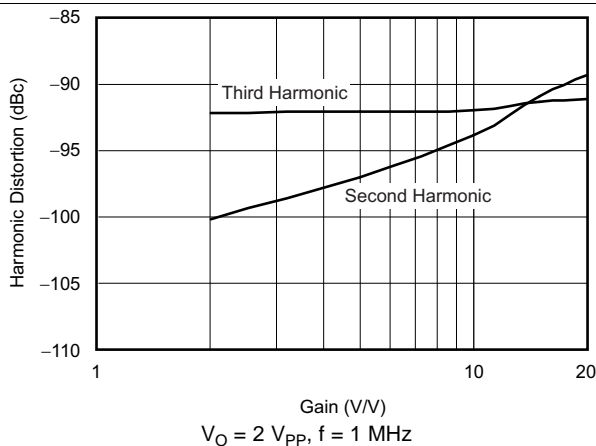

Figure 29. Harmonic Distortion vs Noninverting Gain

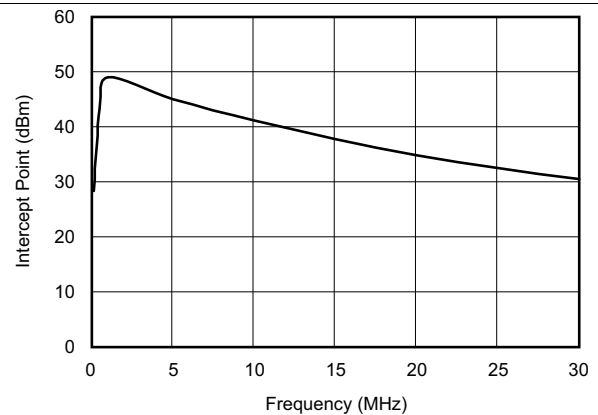
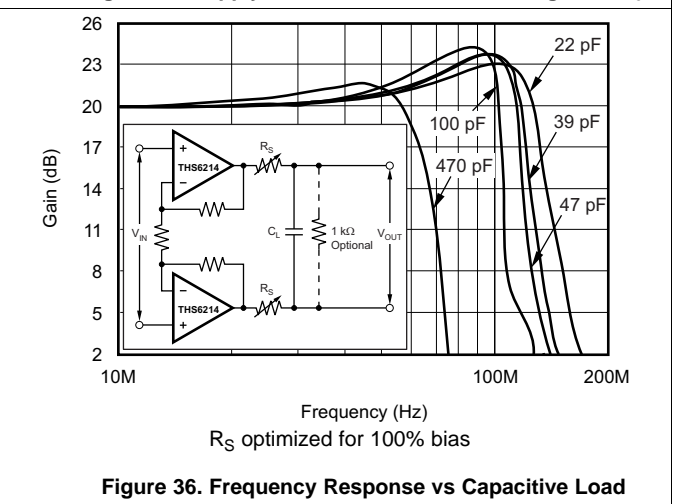
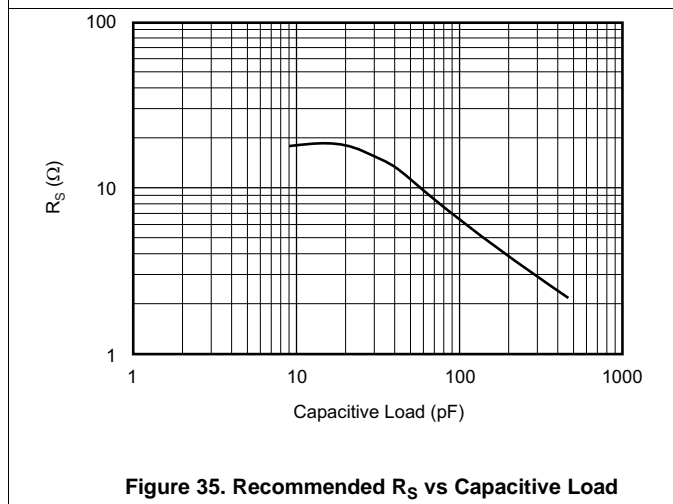
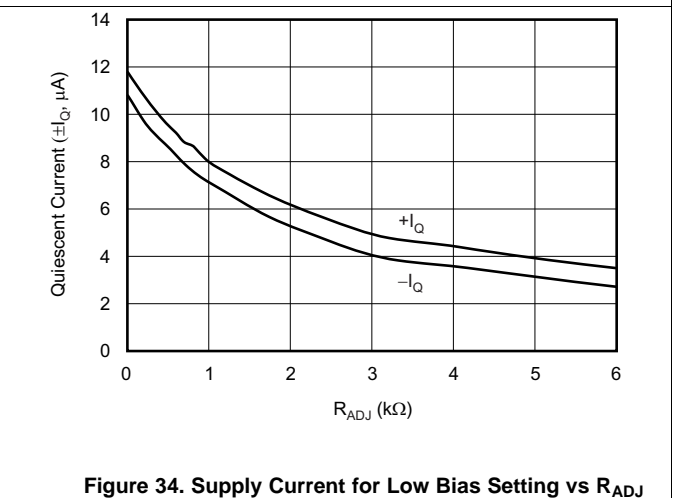
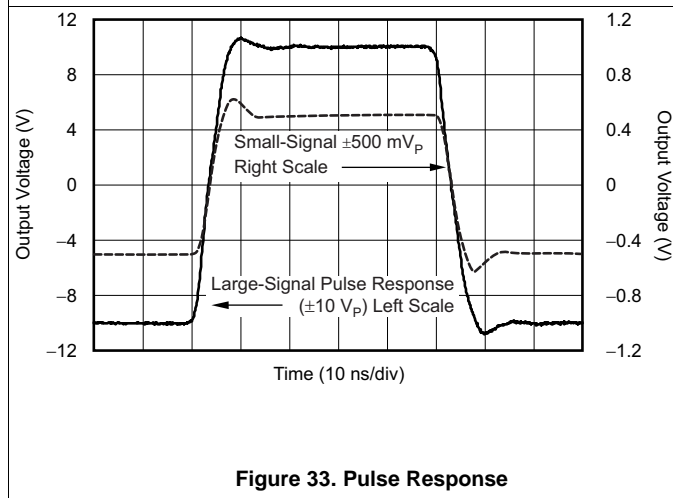
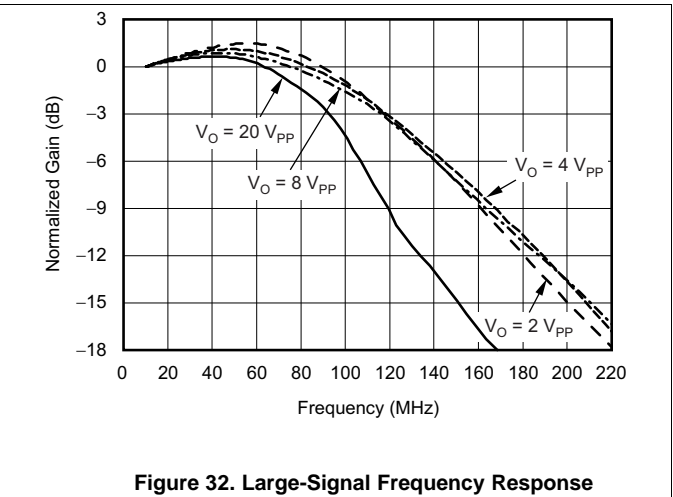
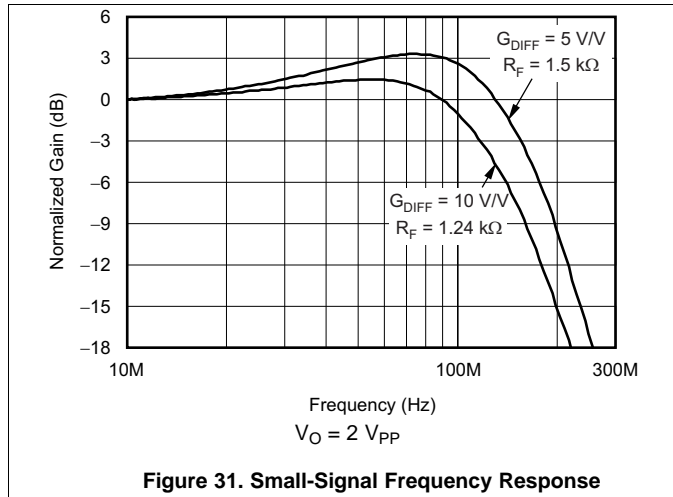

Figure 30. Two-Tone, Third-Order Intermodulation Intercept

6.10 Typical Characteristics: $V_S = \pm 12\text{ V}$, Low Bias

at $T_A = 25^\circ\text{C}$, $G_{\text{DIFF}} = 10\text{ V/V}$, $G_{\text{CM}} = 1\text{ V/V}$, $R_{\text{ADJ}} = 0\ \Omega$, $R_F = 1.24\text{ k}\Omega$, and $R_L = 100\ \Omega$ (unless otherwise noted)



Typical Characteristics: $V_S = \pm 12\text{ V}$, Low Bias (continued)

at $T_A = 25^\circ\text{C}$, $G_{DIFF} = 10\text{ V/V}$, $G_{CM} = 1\text{ V/V}$, $R_{ADJ} = 0\ \Omega$, $R_F = 1.24\text{ k}\Omega$, and $R_L = 100\ \Omega$ (unless otherwise noted)

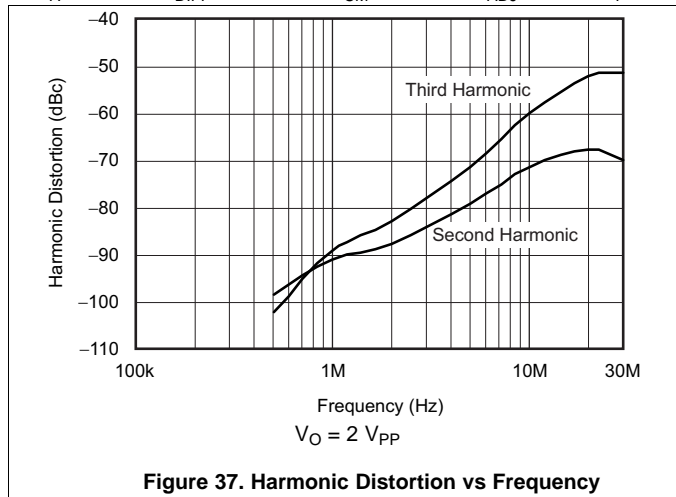

Figure 37. Harmonic Distortion vs Frequency

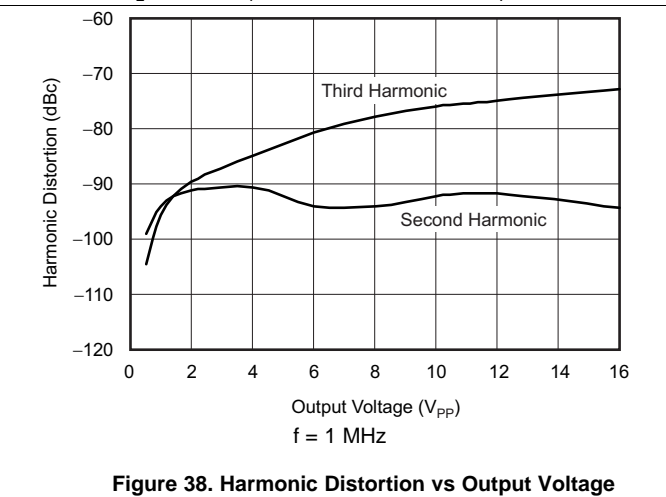

Figure 38. Harmonic Distortion vs Output Voltage

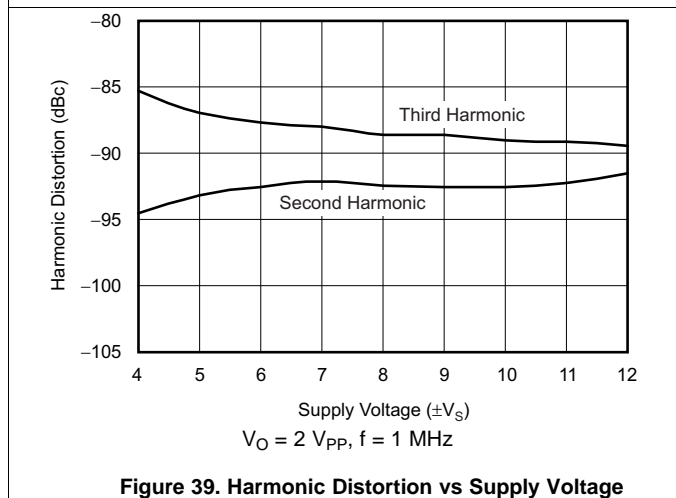

Figure 39. Harmonic Distortion vs Supply Voltage

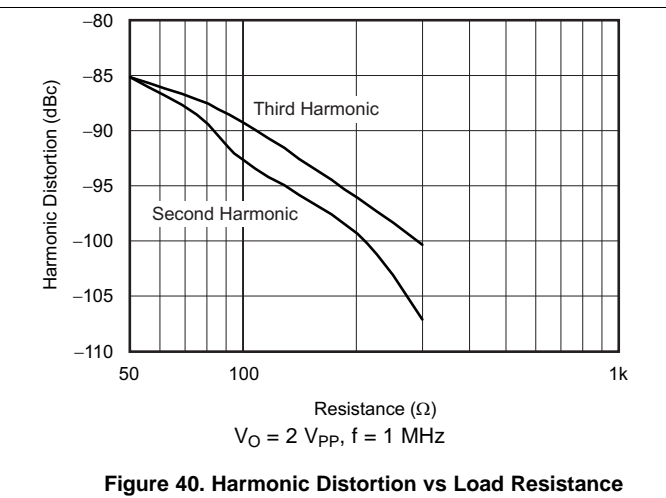

Figure 40. Harmonic Distortion vs Load Resistance

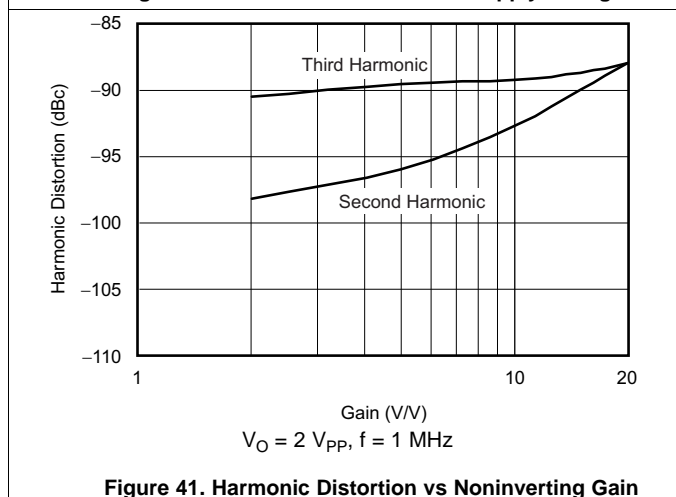

Figure 41. Harmonic Distortion vs Noninverting Gain

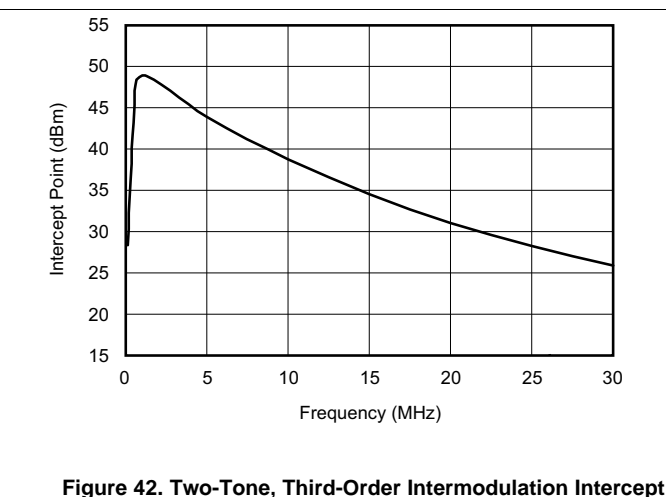

Figure 42. Two-Tone, Third-Order Intermodulation Intercept

6.11 Typical Characteristics: $V_S = \pm 6\text{ V}$, Full Bias

at $T_A = 25^\circ\text{C}$, $G_{\text{DIFF}} = 5\text{ V/V}$, $G_{\text{CM}} = 1\text{ V/V}$, $R_{\text{ADJ}} = 0\ \Omega$, $R_F = 1.82\text{ k}\Omega$, and $R_L = 100\ \Omega$ (unless otherwise noted)

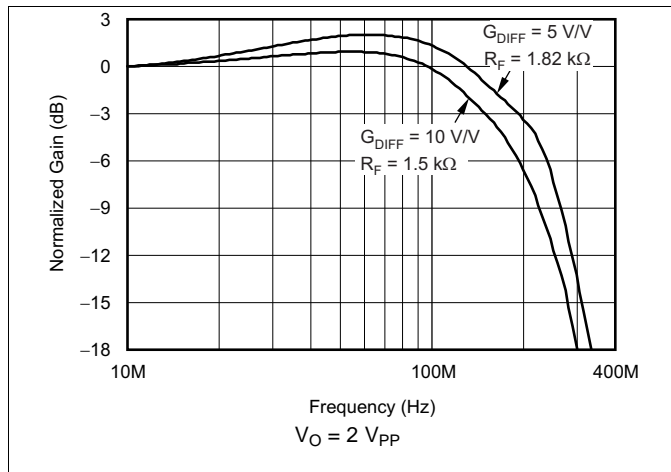

Figure 43. Small-Signal Frequency Response

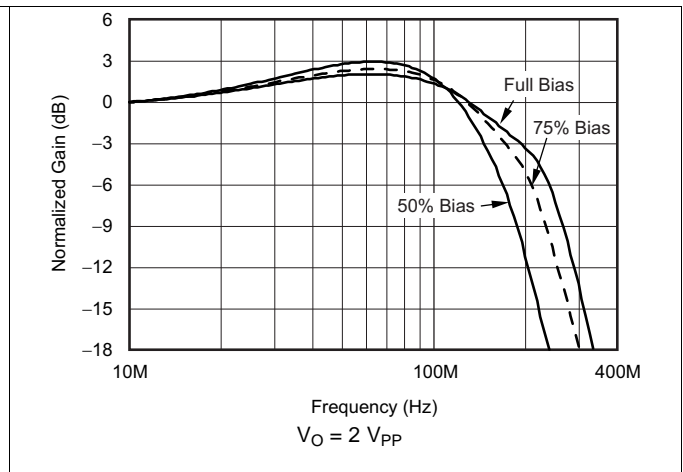

Figure 44. Small-Signal Frequency Response vs Bias

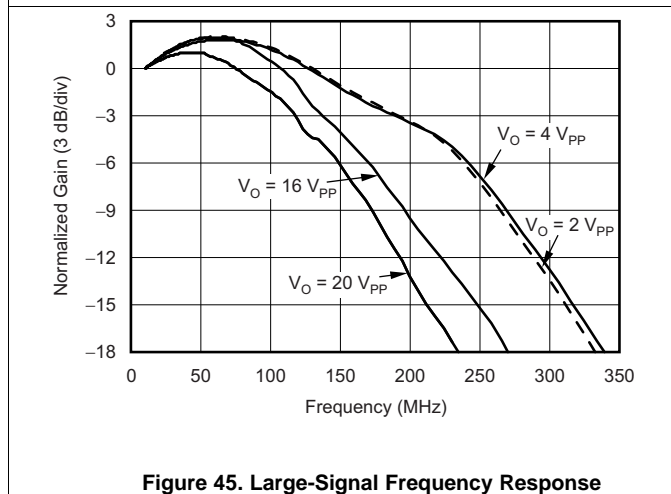

Figure 45. Large-Signal Frequency Response

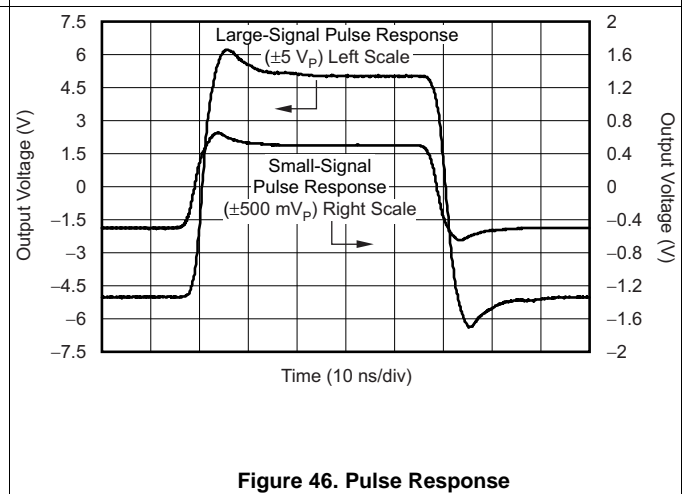

Figure 46. Pulse Response

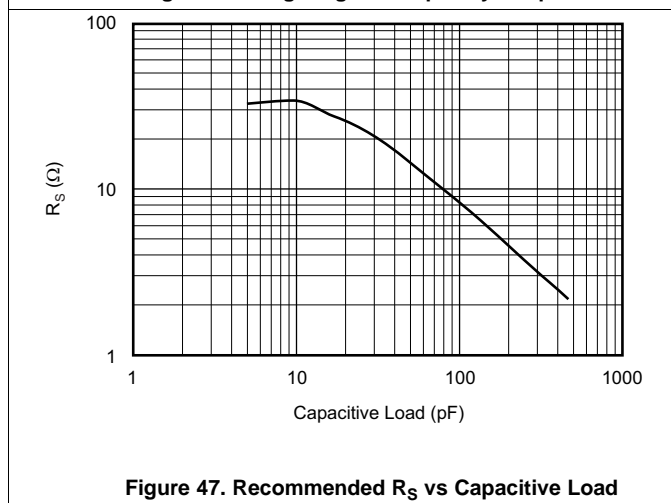

Figure 47. Recommended R_S vs Capacitive Load

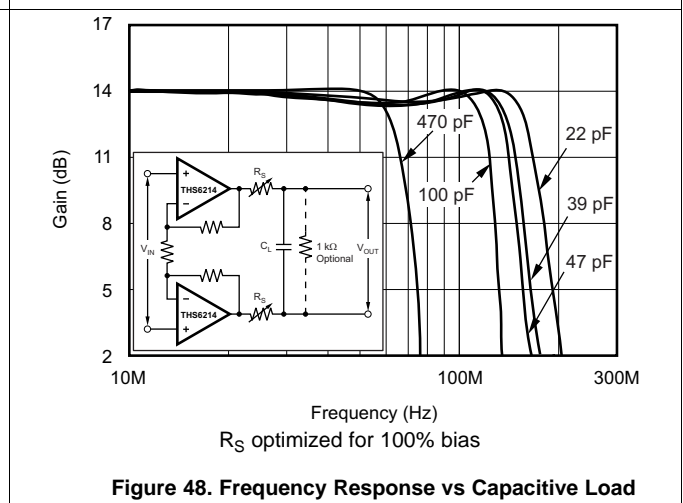

Figure 48. Frequency Response vs Capacitive Load

Typical Characteristics: $V_S = \pm 6\text{ V}$, Full Bias (continued)

at $T_A = 25^\circ\text{C}$, $G_{DIFF} = 5\text{ V/V}$, $G_{CM} = 1\text{ V/V}$, $R_{ADJ} = 0\ \Omega$, $R_F = 1.82\text{ k}\Omega$, and $R_L = 100\ \Omega$ (unless otherwise noted)

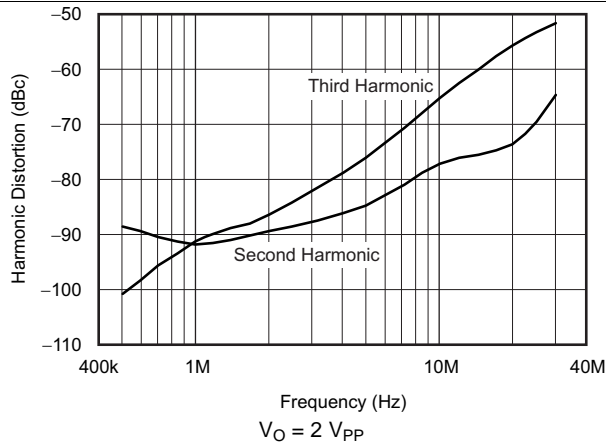

Figure 49. Harmonic Distortion vs Frequency

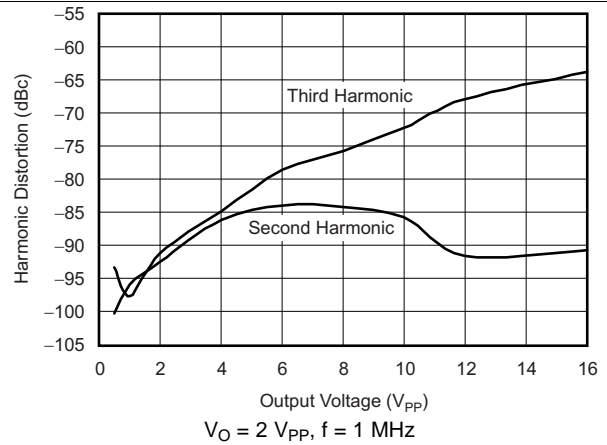

Figure 50. Harmonic Distortion vs Output Voltage

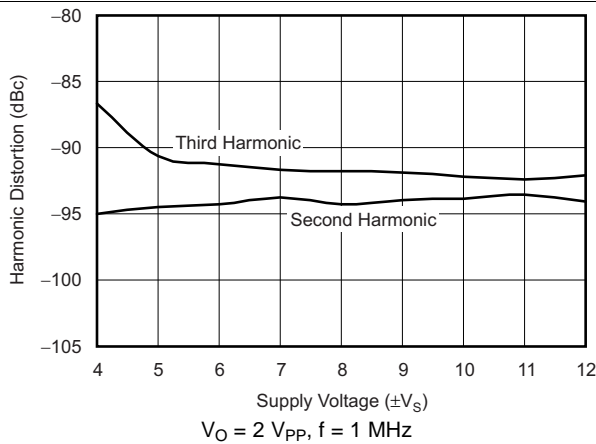

Figure 51. Harmonic Distortion vs Supply Voltage

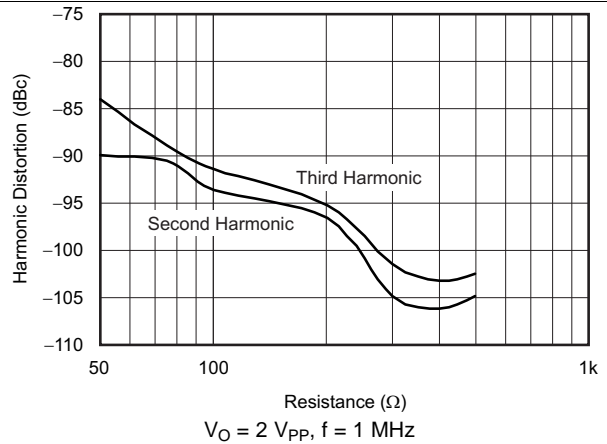

Figure 52. Harmonic Distortion vs Load Resistance

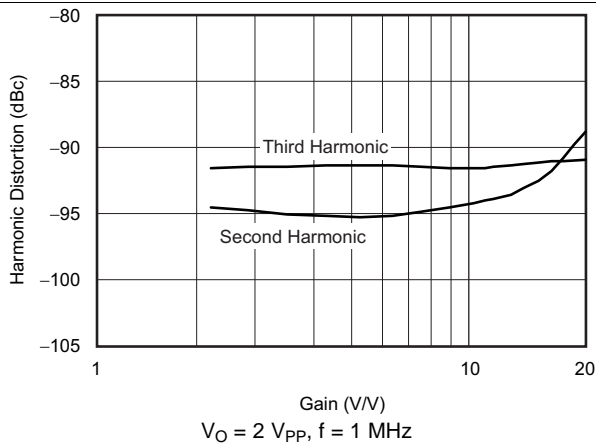

Figure 53. Harmonic Distortion vs Noninverting Gain

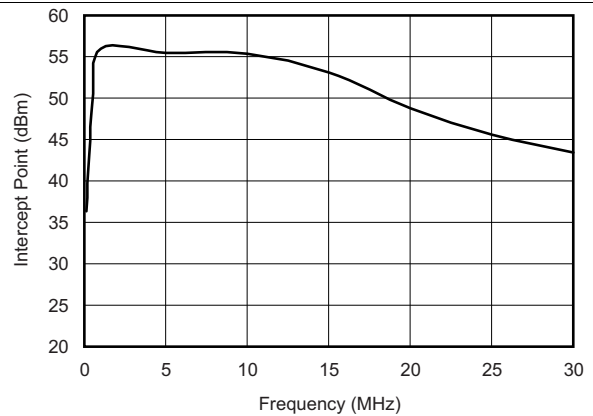

Figure 54. Two-Tone, Third-Order Intermodulation Intercept

Typical Characteristics: $V_S = \pm 6\text{ V}$, Full Bias (continued)

at $T_A = 25^\circ\text{C}$, $G_{DIFF} = 5\text{ V/V}$, $G_{CM} = 1\text{ V/V}$, $R_{ADJ} = 0\ \Omega$, $R_F = 1.82\text{ k}\Omega$, and $R_L = 100\ \Omega$ (unless otherwise noted)

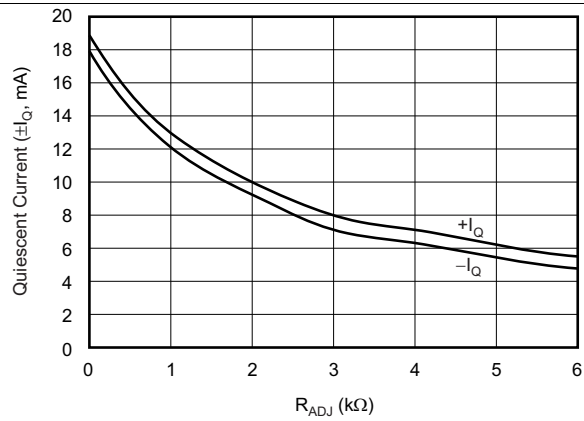

Figure 55. Quiescent Current for Full Bias Setting vs R_{ADJ}

6.12 Typical Characteristics: $V_S = \pm 6\text{ V}$, Mid Bias

at $T_A = 25^\circ\text{C}$, $G_{\text{DIFF}} = 5\text{ V/V}$, $G_{\text{CM}} = 1\text{ V/V}$, $R_{\text{ADJ}} = 0\ \Omega$, $R_F = 1.82\text{ k}\Omega$, and $R_L = 100\ \Omega$ (unless otherwise noted)

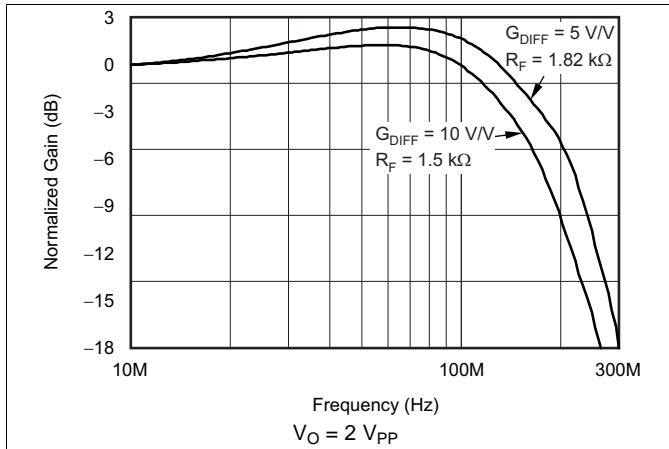

Figure 56. Small-Signal Frequency Response

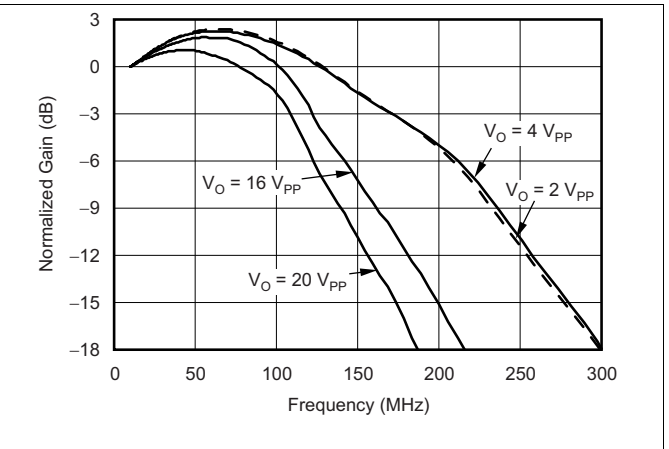

Figure 57. Large-Signal Frequency Response

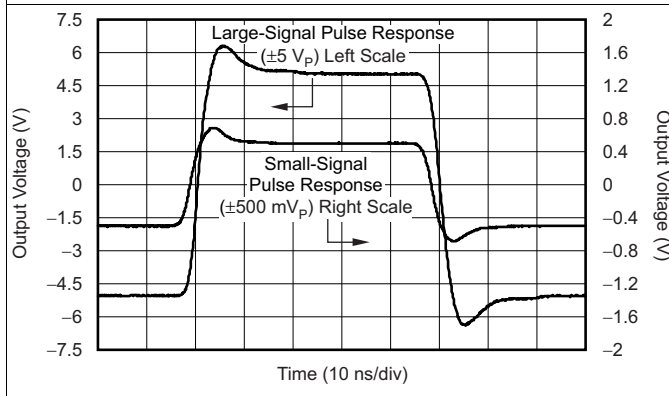

Figure 58. Pulse Response

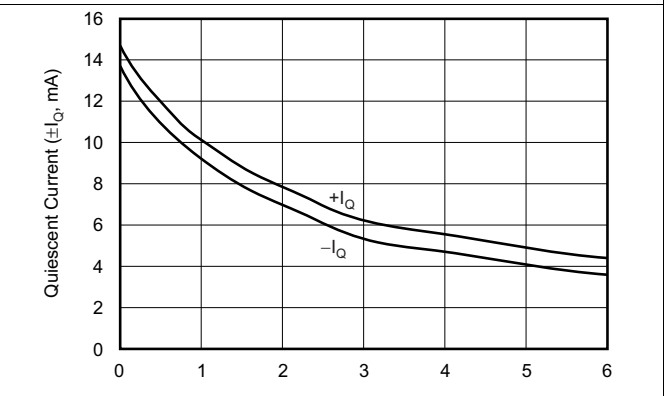

Figure 59. Quiescent Current for Mid Bias Setting vs R_{ADJ}

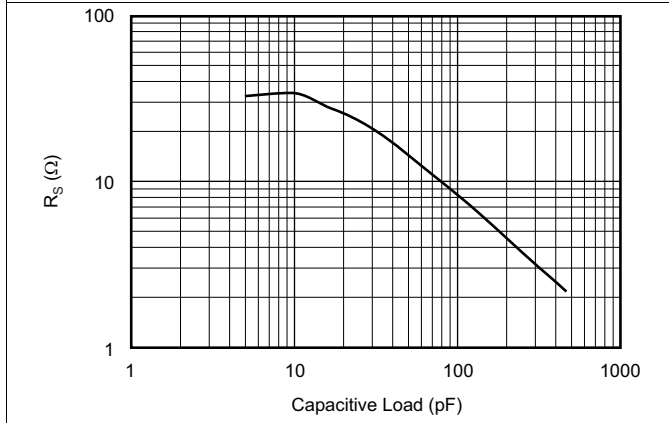

Figure 60. Recommended R_S vs Capacitive Load

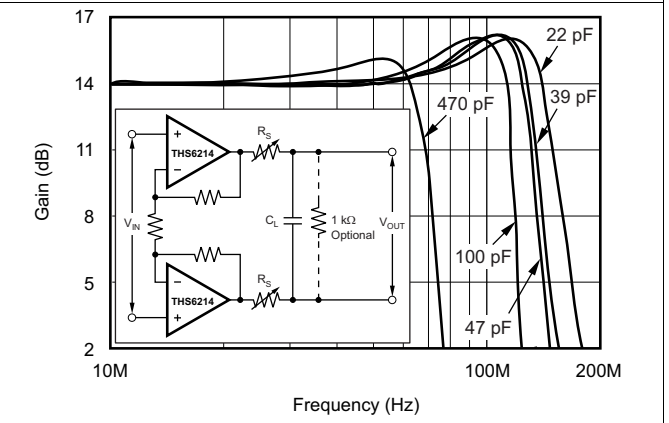

Figure 61. Frequency Response vs Capacitive Load

Typical Characteristics: $V_S = \pm 6\text{ V}$, Mid Bias (continued)

at $T_A = 25^\circ\text{C}$, $G_{DIFF} = 5\text{ V/V}$, $G_{CM} = 1\text{ V/V}$, $R_{ADJ} = 0\ \Omega$, $R_F = 1.82\text{ k}\Omega$, and $R_L = 100\ \Omega$ (unless otherwise noted)

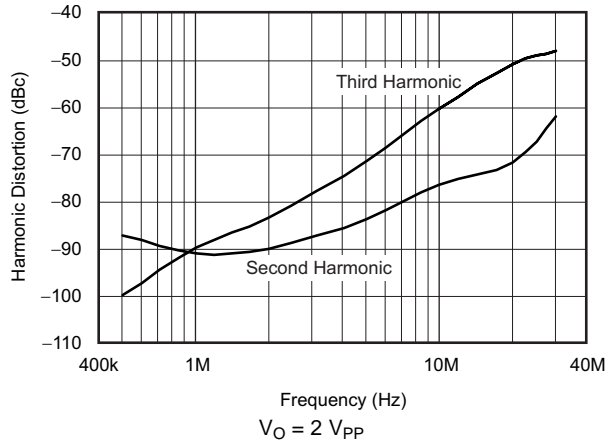

Figure 62. Harmonic Distortion vs Frequency

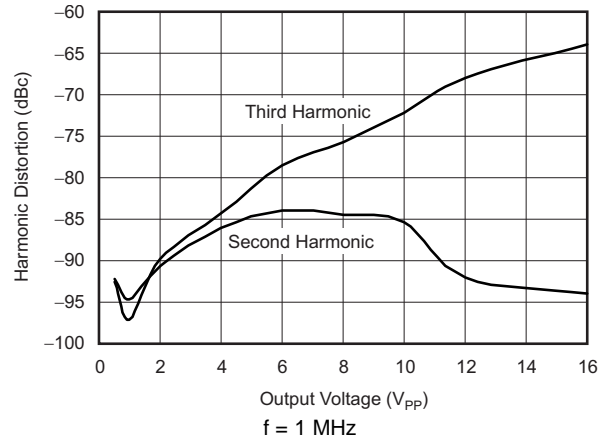

Figure 63. Harmonic Distortion vs Output Voltage

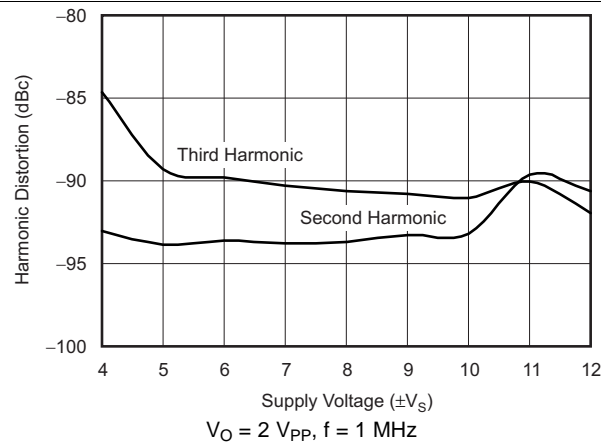

Figure 64. Harmonic Distortion vs Supply Voltage

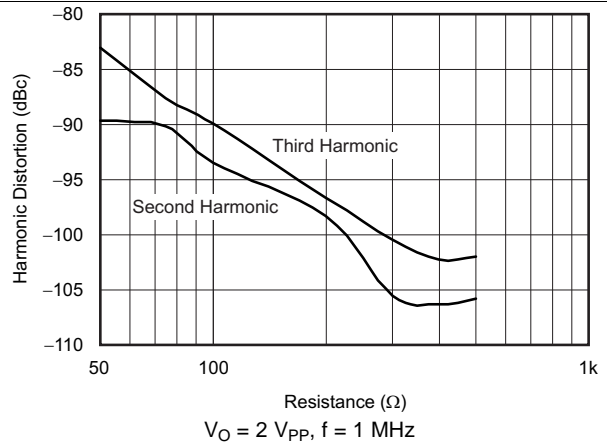

Figure 65. Harmonic Distortion vs Load Resistance

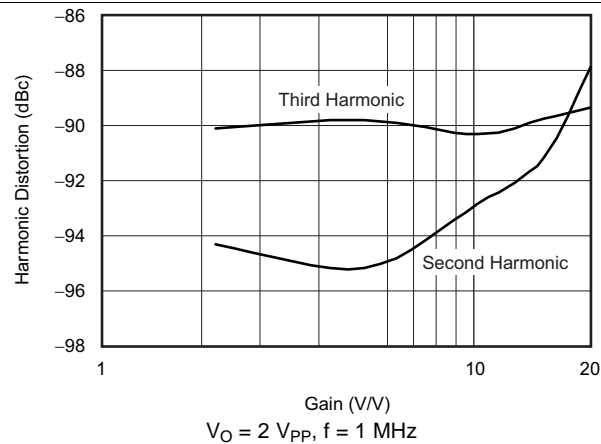

Figure 66. Harmonic Distortion vs Noninverting Gain

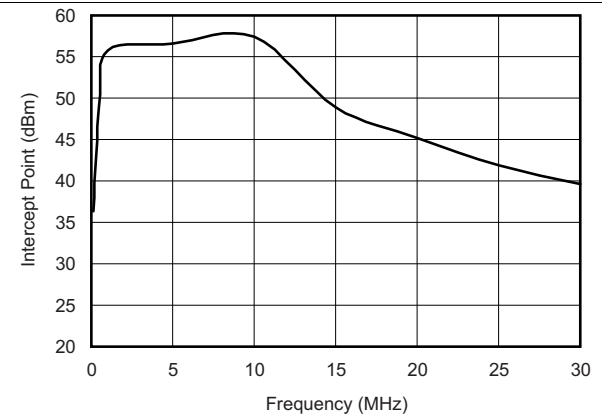

Figure 67. Two-Tone, Third-Order Intermodulation Intercept

6.13 Typical Characteristics: $V_S = \pm 6\text{ V}$, Low Bias

at $T_A = 25^\circ\text{C}$, $G_{\text{DIFF}} = 5\text{ V/V}$, $G_{\text{CM}} = 1\text{ V/V}$, $R_{\text{ADJ}} = 0\ \Omega$, $R_F = 1.82\text{ k}\Omega$, and $R_L = 100\ \Omega$ (unless otherwise noted)

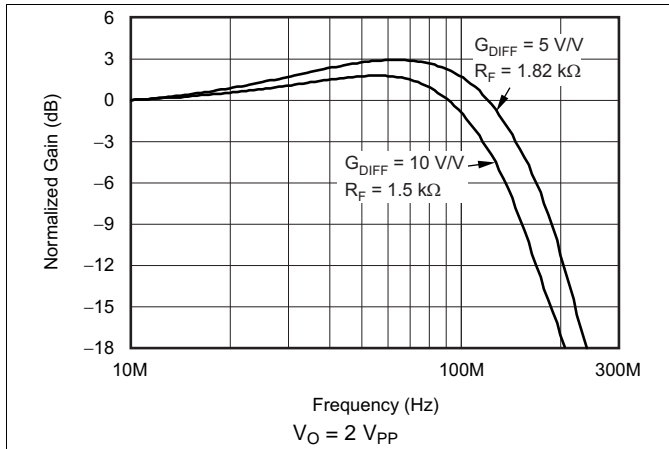

Figure 68. Small-Signal Frequency Response

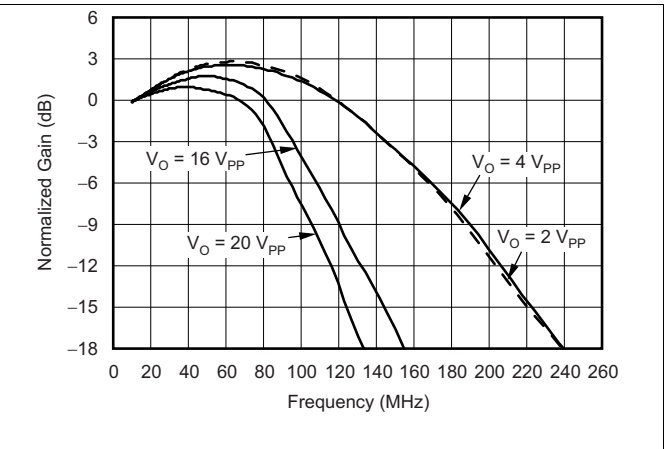

Figure 69. Large-Signal Frequency Response

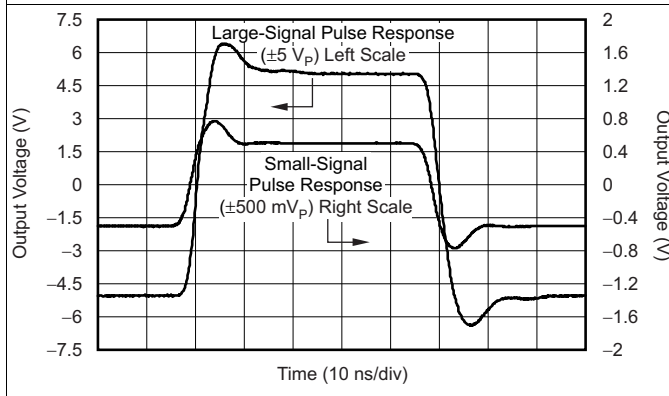

Figure 70. Pulse Response

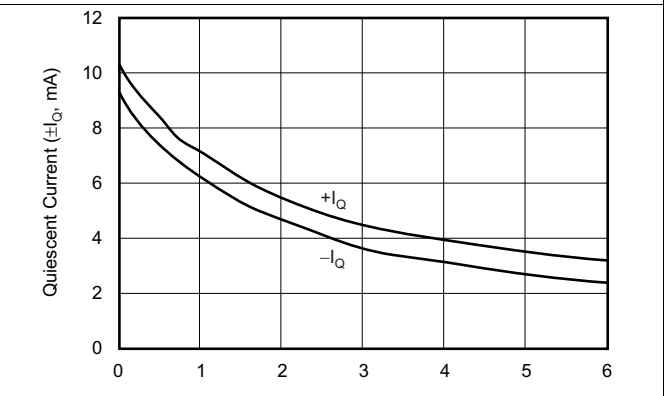

Figure 71. Quiescent Current for Low Bias Setting vs R_{ADJ}

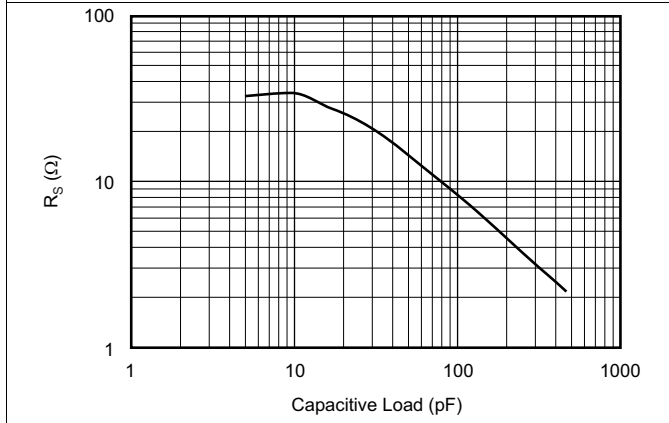

Figure 72. Recommended R_S vs Capacitive Load

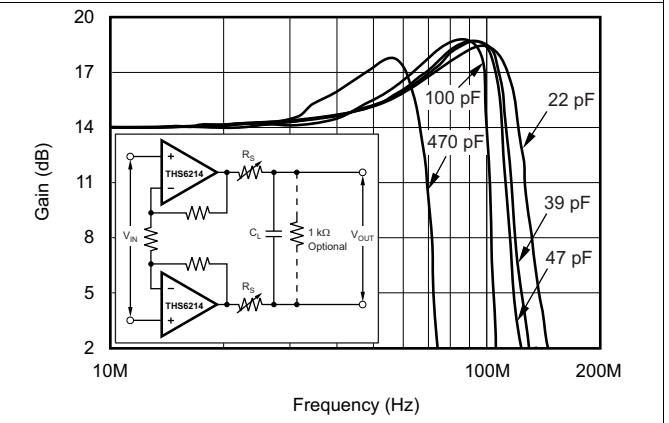
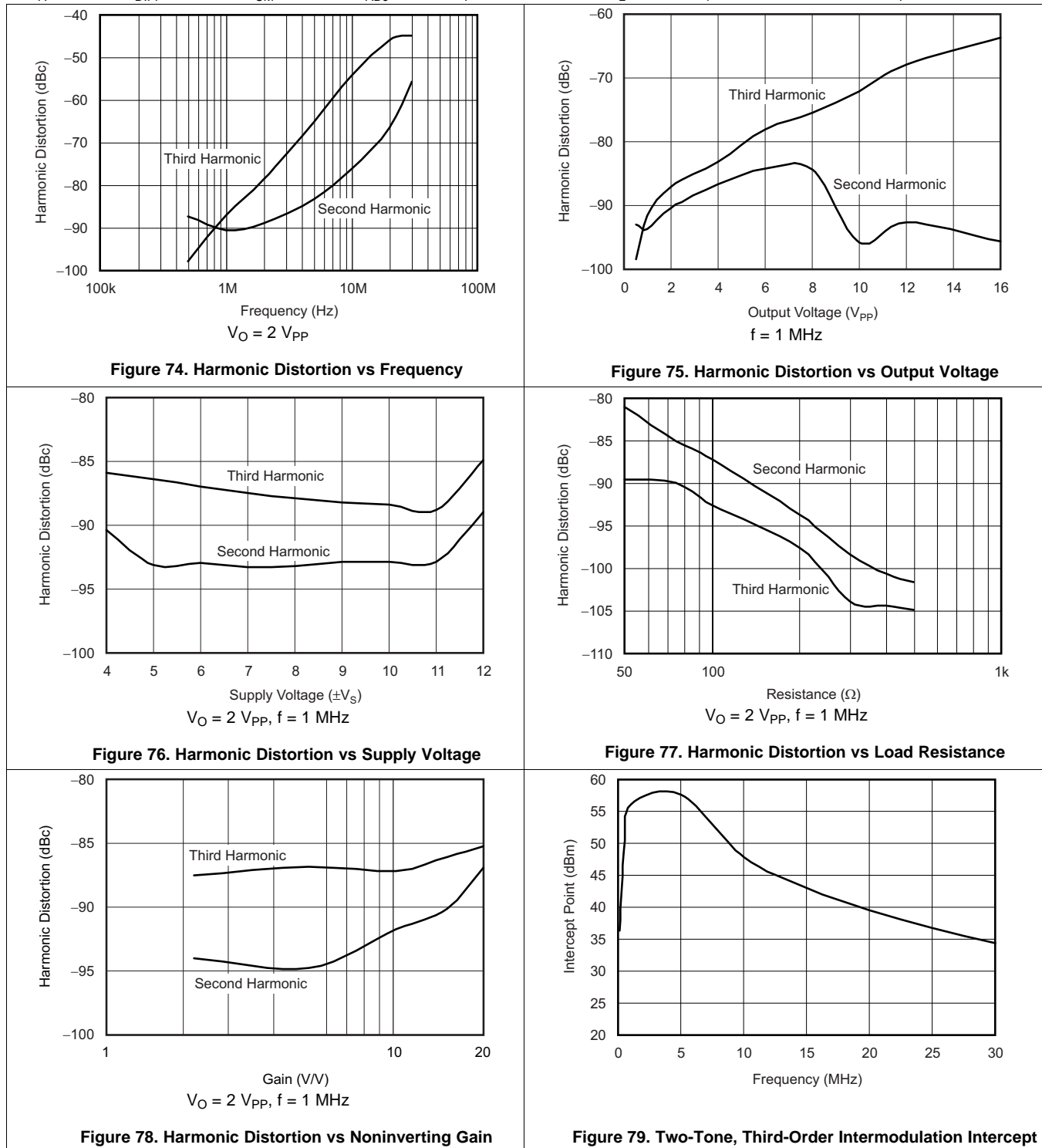

Figure 73. Frequency Response vs Capacitive Load

Typical Characteristics: $V_S = \pm 6\text{ V}$, Low Bias (continued)

at $T_A = 25^\circ\text{C}$, $G_{DIFF} = 5\text{ V/V}$, $G_{CM} = 1\text{ V/V}$, $R_{ADJ} = 0\ \Omega$, $R_F = 1.82\text{ k}\Omega$, and $R_L = 100\ \Omega$ (unless otherwise noted)



7 Detailed Description

7.1 Overview

The THS6214 is a differential line-driver amplifier with a current-feedback architecture. The device is targeted for use in line-driver applications (such as xDSL and wide-band, power-line communications) and is fast enough to support transmissions of 14.5-dBm line power up to 30 MHz. The architecture of the THS6214 is designed to provide maximum flexibility with multiple bias settings that are selectable based on application performance requirements, and also provides an external current pin (I_{ADJ}) to further adjust the bias current to the device. The wide output swing (43.2 V_{PP}) and high current drive (416 mA) of the THS6214 make the device ideally suited for high-power, line-driving applications.

7.2 Functional Block Diagram

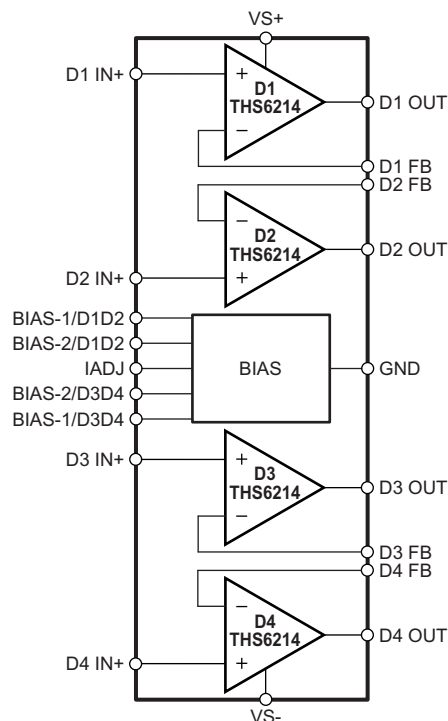

Copyright © 2017, Texas Instruments Incorporated

7.3 Feature Description

7.3.1 Output Current and Voltage

The THS6214 provides output voltage and current capabilities that are unsurpassed in a low-cost, dual monolithic op amp. Under no-load conditions at 25°C, the output voltage typically swings closer than 1.1 V to either supply rail; tested at 25°C, the swing limit is within 1.4 V of either rail into a 100-Ω differential load. Into a 25-Ω load (the minimum tested load), the amplifier delivers more than ±408-mA continuous and greater than ±1-A peak output current.

The specifications described in the previous paragraph, though familiar in the industry, consider voltage and current limits separately. In many applications, the voltage times current (or V-I product) is more relevant to circuit operation. See the *Output Voltage and Current Limitations* plot (Figure 13) in the *Typical Characteristics* section. The X- and Y-axes of this graph show the zero-voltage output current limit and the zero-current output voltage limit, respectively. The four quadrants give a more detailed view of the THS6214 output drive capabilities, noting that the graph is bounded by a safe operating area of 1-W maximum internal power dissipation (in this case, for one channel only). Superimposing resistor load lines onto the plot illustrates that the THS6214 can drive ±10.9 V into 100 Ω or ±10.5 V into 50 Ω without exceeding the output capabilities or the 1-W dissipation limit. A 100-Ω load line (the standard test circuit load) illustrates the full ±12-V output swing capability, as provided in the

Feature Description (continued)

Electrical Characteristics tables. The minimum specified output voltage and current over temperature are set by worst-case simulations at the cold temperature extreme. Only at cold startup do the output current and voltage decrease to the numbers provided in the *Electrical Characteristics* tables. When the output transistors deliver power, the junction temperature increases, decreasing the V_{BEs} (increasing the available output voltage swing), and increasing the current gains (increasing the available output current). In steady-state operation, the available output voltage and current are always greater than that shown in the overtemperature specifications, because the output stage junction temperatures are higher than the minimum specified operating ambient temperature. To maintain maximum output stage linearity, no output short-circuit protection is provided. This absence of short-circuit protection is normally not a problem because most applications include a series-matching resistor at the output that limits the internal power dissipation if the output side of this resistor is shorted to ground. However, shorting the output pin directly to the adjacent positive power-supply pin (24-pin package), in most cases destroys the amplifier. If additional short-circuit protection is required, a small series resistor can be included in the supply lines. Under heavy output loads, this additional resistor reduces the available output voltage swing. A 5- Ω series resistor in each power-supply lead limits the internal power dissipation to less than 1 W for an output short-circuit, and decreases the available output voltage swing only 0.5 V for up to 100-mA desired load currents. Always place the 0.1- μ F power-supply decoupling capacitors after these supply current limiting resistors, directly on the supply pins.

7.3.2 Driving Capacitive Loads

One of the most demanding and yet very common load conditions for an op amp is capacitive loading. Often, the capacitive load is the input of an ADC—including additional external capacitance that may be recommended to improve the ADC linearity. A high-speed, high open-loop gain amplifier such as the THS6214 can be very susceptible to decreased stability and closed-loop response peaking when a capacitive load is placed directly on the output pin. When the amplifier open-loop output resistance is considered, this capacitive load introduces an additional pole in the signal path that can decrease the phase margin. Several external solutions to this problem have been suggested below.

When the primary considerations are frequency response flatness, pulse response fidelity, and distortion, the simplest and most effective solution is to isolate the capacitive load from the feedback loop by inserting a series isolation resistor between the amplifier output and the capacitive load. This series resistor does not eliminate the pole from the loop response, but shifts the pole and adds a zero at a higher frequency. The additional zero functions to cancel the phase lag from the capacitive load pole, thus increasing the phase margin and improving stability. The *Typical Characteristics* illustrate the recommended R_S versus capacitive load (see [Figure 5](#), [Figure 23](#), [Figure 35](#), [Figure 47](#), [Figure 60](#), and [Figure 72](#)) and the resulting frequency response at the load. Parasitic capacitive loads greater than 2 pF can begin to degrade device performance. Long printed-circuit board (PCB) traces, unmatched cables, and connections to multiple devices can easily cause this value to be exceeded. Always consider this effect carefully, and add the recommended series resistor as close as possible to the THS6214 output pin (see the [Board Layout Guidelines](#) section).

7.3.3 Distortion Performance

The THS6214 provides good distortion performance into a 100- Ω load on ± 12 -V supplies. Relative to alternative solutions, the amplifier provides exceptional performance into lighter loads and operation on a dual ± 6 -V supply. Generally, until the fundamental signal reaches very high frequency or power levels, the second harmonic dominates the distortion with a negligible third-harmonic component. Focusing then on the second harmonic, increasing the load impedance improves distortion directly. Remember that the total load includes the feedback network—in the noninverting configuration (see [Figure 81](#)), this value is the sum of $R_F + R_G$, whereas in the inverting configuration this value is just R_F . Also, providing an additional supply decoupling capacitor (0.01 μ F) between the supply pins (for bipolar operation) improves the second-order distortion slightly (from 3 dB to 6 dB).

In most op amps, increasing the output voltage swing directly increases harmonic distortion. The *Typical Characteristics* illustrate the second harmonic increasing at a little less than the expected 2x rate, whereas the third harmonic increases at a little less than the expected 3x rate. Where the test power doubles, the second harmonic decreases less than the expected 6 dB, and the third harmonic decreases by less than the expected 12 dB. This difference also appears in the two-tone, third-order intermodulation spurious (IM3) response curves. The third-order spurious levels are extremely low at low-output power levels, and the output stage continues to hold them low even when the fundamental power reaches very high levels.

Feature Description (continued)

7.3.4 Differential Noise Performance

The THS6214 is designed to be used as a differential driver in xDSL applications. Therefore, analyzing the noise in such a configuration is important. Figure 80 shows the op amp noise model for the differential configuration.

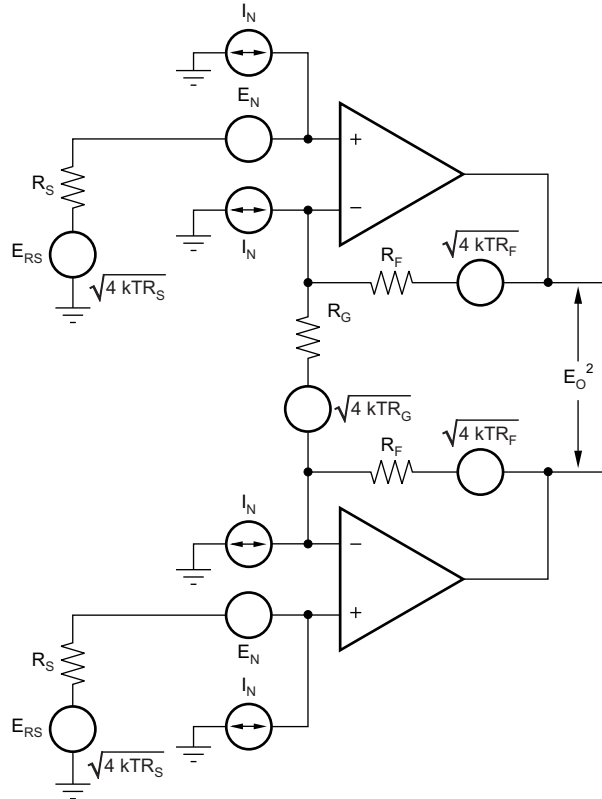

Figure 80. Differential Op Amp Noise Analysis Model

As a reminder, the differential gain is expressed as given in Equation 1:

$$G_D = 1 + \frac{2 \times R_F}{R_G} \quad (1)$$

The output noise can be expressed as shown in Equation 2:

$$E_O = \sqrt{2 \times G_D^2 \times \left[e_N^2 + (i_N \times R_S)^2 + 4 kTR_S \right] + 2(i_I R_F)^2 + 2(4 kTR_F G_D)} \quad (2)$$

Dividing this expression by the differential noise gain [$G_D = (1 + 2R_F / R_G)$] gives the equivalent input-referred spot noise voltage at the noninverting input, as shown in Equation 3.

$$E_O = \sqrt{2 \times \left[e_N^2 + (i_N \times R_S)^2 + 4 kTR_S \right] + 2 \left[\frac{i_I R_F}{G_D} \right]^2 + 2 \left[\frac{4 kTR_F}{G_D} \right]} \quad (3)$$

Evaluating these equations for the THS6214 ADSL circuit and component values of Figure 84 gives a total output spot noise voltage of 38.9 nV/ $\sqrt{\text{Hz}}$ and a total equivalent input spot noise voltage of 7 nV/ $\sqrt{\text{Hz}}$.

In order to minimize the output noise as a result of the noninverting input bias current noise, keeping the noninverting source impedance as low as possible is recommended.

Feature Description (continued)

7.3.5 DC Accuracy and Offset Control

A current-feedback op amp such as the THS6214 provides exceptional bandwidth in high gains, giving fast pulse settling but only moderate dc accuracy. The [Electrical Characteristics](#) describe an input offset voltage comparable to high-speed, voltage-feedback amplifiers; however, the two input bias currents are somewhat higher and are unmatched. Although bias current cancellation techniques are very effective with most voltage-feedback op amps, these techniques do not generally reduce the output dc offset for wideband current-feedback op amps. Because the two input bias currents are unrelated in both magnitude and polarity, matching the input source impedance to reduce error contribution to the output is ineffective. Evaluating the configuration of [Figure 81](#), using a worst-case condition at 25°C input offset voltage and the two input bias currents, gives a worst-case output offset range equal to [Equation 4](#):

$$\begin{aligned}
 V_{\text{OFF}} &= \pm \left(\text{NG} \times V_{\text{OS(MAX)}} \right) + \left(I_{\text{BN}} \times \frac{R_{\text{S}}}{2} \times \text{NG} \right) \pm (I_{\text{BI}} \times R_{\text{F}}) \\
 &= \pm (10 \times 5 \text{ mV}) + (3.5 \mu\text{A} \times 25 \Omega \times 10) \pm (1.24 \text{ k}\Omega \times 45 \mu\text{A}) \\
 &= \pm 50 \text{ mV} + 0.875 \text{ mV} \pm 55.5 \text{ mV} \\
 V_{\text{OFF}} &= -104.92 \text{ mV to } 106.67 \text{ mV}
 \end{aligned}$$

where

- NG = noninverting signal gain (4)

7.4 Device Functional Modes

The THS6214 has four different functional modes for each port set by the BIAS-1/xxxx and BIAS-2/xxxx pins. [Table 2](#) shows the truth table for the device mode pin configuration and the associated description of each mode.

Table 2. Bias Logic Table

BIAS-1/XXXX	BIAS-2/XXXX	FUNCTION	DESCRIPTION
0	0	Full-bias mode (100%)	Amplifiers on with lowest distortion possible (default state)
1	0	Mid-bias mode (75%)	Amplifiers on with power savings and a reduction in distortion performance
0	1	Low-bias mode (50%)	Amplifiers on with enhanced power savings and a reduction of overall performance
1	1	Shutdown mode	Amplifiers off and output has high impedance

8 Application and Implementation

NOTE

Information in the following applications sections is not part of the TI component specification, and TI does not warrant its accuracy or completeness. TI's customers are responsible for determining suitability of components for their purposes. Customers should validate and test their design implementation to confirm system functionality.

8.1 Application Information

The THS6214 is typically used to drive high output power applications with various load conditions. In the [Typical Applications](#) section, the amplifier is presented in a general-purpose, wideband, current-feedback configuration, and a more specific 100-Ω twisted pair cable line driver. However, the amplifier is also applicable for many different general-purpose and specific cable line-driving scenarios beyond what is described in the [Typical Applications](#) section.

8.2 Typical Applications

8.2.1 Wideband Current-Feedback Operation

The THS6214 provides the exceptional ac performance of a wideband current-feedback op amp with a highly linear, high-power output stage. Requiring only 21-mA/port quiescent current, the THS6214 swings to within 1.9 V of either supply rail on a 100-Ω load and delivers in excess of 416 mA at room temperature. This low-output headroom requirement, along with supply voltage independent biasing, provides remarkable ±6-V supply operation. The THS6214 delivers greater than 140-MHz bandwidth driving a 2-V_{PP} output into 100 Ω on a ±6-V supply. Previous boosted output stage amplifiers typically suffer from very poor crossover distortion when the output current goes through zero. The THS6214 achieves a comparable power gain with much better linearity. The primary advantage of a current-feedback op amp over a voltage-feedback op amp is that ac performance (bandwidth and distortion) is relatively independent of signal gain. [Figure 81](#) shows the dc-coupled, gain of 10 V/V, dual power-supply circuit configuration used as the basis of the ±12-V [Electrical Characteristics](#) and [Typical Characteristics](#). For test purposes, the input impedance is set to 50 Ω with a resistor to ground and the output impedance is set to 50 Ω with a series output resistor. Voltage swings reported in the [Electrical Characteristics](#) are taken directly at the input and output pins, whereas load powers (dBm) are defined at a matched 50-Ω load.

For the circuit of [Figure 81](#), the total effective load is 100 Ω || 1.24 kΩ || 1.24 kΩ = 86.1 Ω.

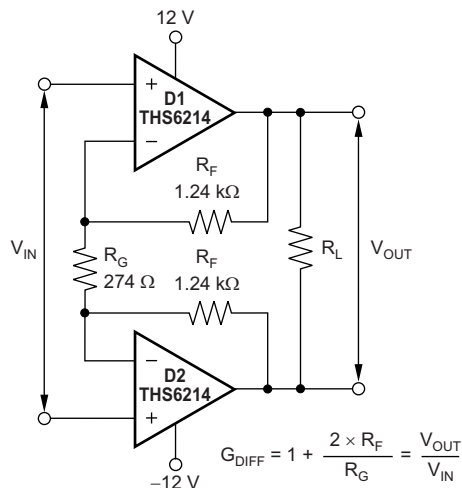

Figure 81. Noninverting Differential I/O Amplifier

Typical Applications (continued)

8.2.1.1 Design Requirements

The main design requirements for wideband current-feedback operation are to choose power supplies that satisfy common-mode requirements at the input and output of the device, and also to use a feedback resistor value that allows for the proper bandwidth when maintaining stability. These requirements and the proper solutions are described in the [Detailed Design Procedure](#) section. Using transformers and split power supplies can be required for certain applications.

8.2.1.2 Detailed Design Procedure

For ease of test purposes in this design, the THS6214 input impedance is set to 50 Ω with a resistor to ground and the output impedance is set to 50 Ω with a series output resistor. Voltage swings reported in the [Electrical Characteristics](#) tables are taken directly at the input and output pins, whereas load powers (dBm) are defined at a matched 50- Ω load. For the circuit of [Figure 81](#), the total effective load is $100\ \Omega \parallel 1.24\ \text{k}\Omega \parallel 1.24\ \text{k}\Omega = 86.1\ \Omega$. This approach allows a source termination impedance to be set at the input that is independent of the signal gain. For instance, simple differential filters can be included in the signal path right up to the noninverting inputs with no interaction with the gain setting. The differential signal gain for the circuit of [Figure 81](#) is given by [Equation 5](#):

$$A_D = 1 + 2 \times \frac{R_F}{R_G}$$

where

- A_D = differential gain (5)

A value of 274 Ω for the $A_D = 10\text{-V/V}$ design is given by [Figure 81](#). The device bandwidth is primarily controlled with the feedback resistor value because the THS6214 is a current-feedback (CFB) amplifier; the differential gain, however, can be adjusted with considerable freedom using just the R_G resistor. In fact, R_G can be reduced by a reactive network that provides a very isolated shaping to the differential frequency response.

Various combinations of single-supply or ac-coupled gain can also be delivered using the basic circuit of [Figure 81](#). Common-mode bias voltages on the two noninverting inputs pass on to the output with a gain of 1 V/V because an equal dc voltage at each inverting node does not create current through R_G . This circuit does show a common-mode gain of 1 V/V from the input to output. The source connection must either remove this common-mode signal if undesired (using an input transformer can provide this function), or the common-mode voltage at the inputs can be used to set the output common-mode bias. If the low common-mode rejection of this circuit is a problem, the output interface can also be used to reject that common-mode signal. For instance, most modern differential input analog-to-digital converters (ADCs) reject common-mode signals very well, and a line-driver application through a transformer also attenuates the common-mode signal through to the line.

Typical Applications (continued)

8.2.1.3 Application Curves

Figure 82 and Figure 83 show the frequency response and distortion performance of the circuit in Figure 81. The measurements are made with a load resistor (R_L) of 100 Ω , and at room temperature. Figure 82 is measured using the three different device power modes, and the distortion measurements in Figure 83 are made at an output voltage level of 2 V_{PP}.

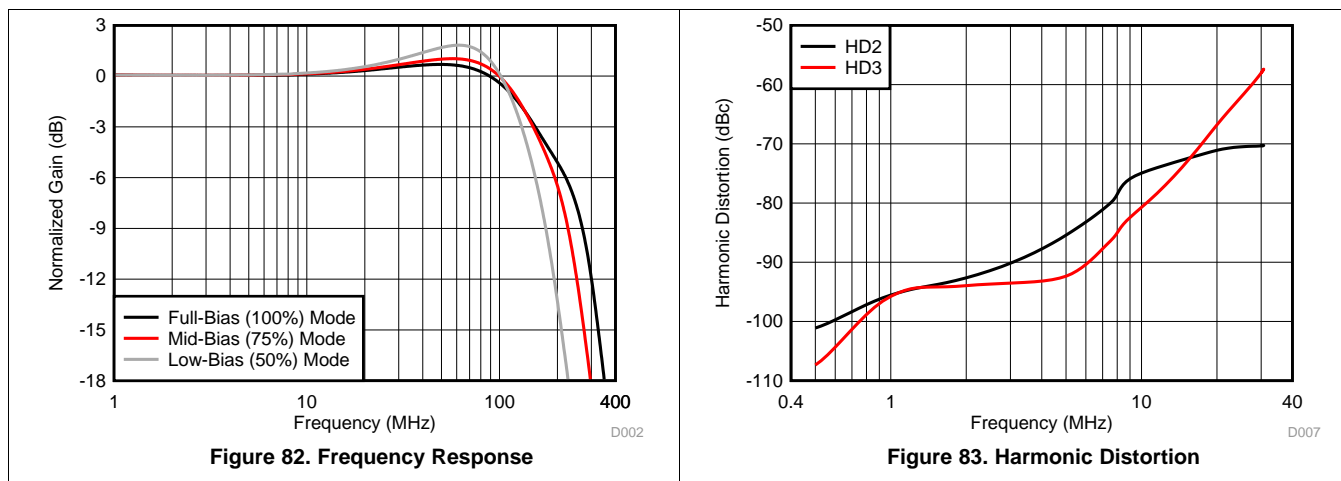

8.2.2 Dual-Supply VDSL Downstream Driver

Figure 84 shows an example of a dual-supply downstream driver with a synthesized output impedance circuit. The THS6214 is configured as a differential gain stage to provide a signal drive to the primary winding of the transformer (a step-up transformer with a turns ratio of 1:n is shown in Figure 84). The main advantage of this configuration is the cancellation of all even harmonic-distortion products. Another important advantage is that each amplifier must only swing half of the total output required driving the load.

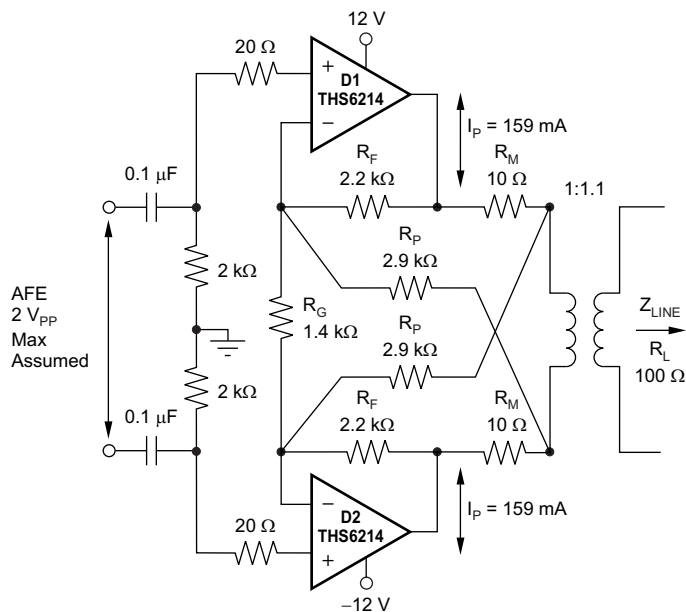

Figure 84. Dual-Supply VDSL Downstream Driver

Typical Applications (continued)

The analog front-end (AFE) signal is ac-coupled to the driver, and the noninverting input of each amplifier is biased to the mid-supply voltage (ground in this case). In addition to providing the proper biasing to the amplifier, this approach also provides a high-pass filtering with a corner frequency that is set at 5 kHz in this example. Because the signal bandwidth starts at 26 kHz, this high-pass filter does not generate any problems and has the advantage of filtering out unwanted lower frequencies.

8.2.2.1 Design Requirements

The main design requirements for [Figure 84](#) are to match the output impedance correctly, satisfy headroom requirements, and ensure that the circuit meets power driving requirements. These requirements are described in the [Detailed Design Procedure](#) section and include the required equations to properly implement the design. The design must be fully worked through before physical implementation because small changes in a single parameter can often have large effects on performance.

8.2.2.2 Detailed Design Procedure

For [Figure 84](#), the input signal is amplified with a gain set by [Equation 6](#):

$$G_D = 1 + \frac{2 \times R_F}{R_G} \quad (6)$$

The two back-termination resistors ($R_M = 10 \, \Omega$, each) added at each terminal of the transformer make the impedance of the amplifier match the impedance of the line, and also provide a means of detecting the received signal for the receiver. The value of these resistors (R_M) is a function of the line impedance and the transformer turns ratio (n), given by [Equation 7](#):

$$R_M = \frac{Z_{\text{LINE}}}{2n^2} \quad (7)$$

8.2.2.2.1 Line Driver Headroom Model Requirements

The first step in a transformer-coupled, twisted-pair driver design is to compute the peak-to-peak output voltage from the target specifications. This calculation is done using [Equation 8](#) to [Equation 11](#):

$$P_L = 10 \times \log \frac{V_{\text{RMS}}^2}{(1 \text{ mW}) \times R_L}$$

where

- P_L = power at the load
 - V_{RMS} = voltage at the load
 - R_L = load impedance
- (8)

These values produce the following:

$$V_{\text{RMS}} = \sqrt{(1 \text{ mW}) \times R_L \times 10 \frac{P_L}{10}} \quad (9)$$

$$V_P = \text{Crest Factor} \times V_{\text{RMS}} = \text{CF} \times V_{\text{RMS}}$$

where

- V_P = peak voltage at the load
 - CF = crest factor
- (10)

$$V_{\text{LPP}} = 2 \times \text{CF} \times V_{\text{RMS}}$$

where

- V_{LPP} = peak-to-peak voltage at the load
- (11)

Typical Applications (continued)

Consolidating Equation 8 to Equation 11 allows the required peak-to-peak voltage at the load to be expressed as a function of the crest factor, the load impedance, and the power at the load, as given by Equation 12:

$$V_{LPP} = 2 \times CF \times \sqrt{(1 \text{ mW}) \times R_L \times 10 \frac{P_L}{10}} \tag{12}$$

V_{LPP} is usually computed for a nominal line impedance and can be taken as a fixed design target.

The next step in the design is to compute the individual amplifier output voltage and currents as a function of peak-to-peak voltage on the line and transformer-turns ratio.

When this turns ratio changes, the minimum allowed supply voltage also changes. The peak current in the amplifier output is given by Equation 13:

$$\pm I_P = \frac{1}{2} \times \frac{2 \times V_{LPP}}{n} \times \frac{1}{4 R_M}$$

where

- V_{PP} is as defined in Equation 12, and
 - R_M is as defined in Equation 7 and Figure 85
- (13)

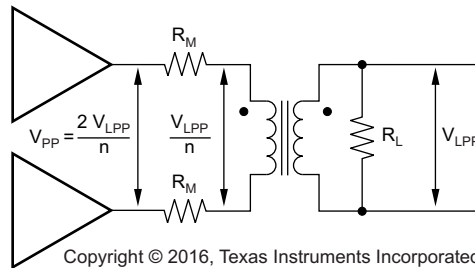

Figure 85. Driver Peak Output Voltage

With the previous information available, a supply voltage and the turns ratio desired for the transformer can now be selected, and the headroom for the THS6214 can be calculated.

The model illustrated in Figure 86 can be described with Equation 14 and Equation 15 as:

1. The available output swing:

$$V_{PP} = V_{CC} - (V_1 + V_2) - I_P \times (R_1 + R_2) \tag{14}$$

2. Or as the required supply voltage:

$$V_{CC} = V_{PP} + (V_1 + V_2) + I_P \times (R_1 + R_2) \tag{15}$$

The minimum supply voltage for power and load requirements is given by Equation 15.

V_1 , V_2 , R_1 , and R_2 are given in Table 3 for the ± 12 -V operation.

Typical Applications (continued)

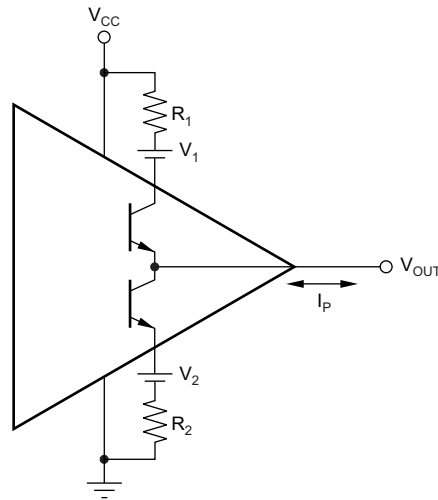

Figure 86. Line Driver Headroom Model

Table 3. Line Driver Headroom Model Values

V _S	V ₁	R ₁	V ₂	R ₂
±12 V	1 V	0.6 Ω	1 V	1.2 Ω

When using a synthetic output impedance circuit (see Figure 84), a significant drop in bandwidth occurs from the specification provided in the *Electrical Characteristics* tables. This apparent drop in bandwidth for the differential signal is a result of the apparent increase in the feedback transimpedance for each amplifier. This feedback transimpedance equation is given by Equation 16:

$$Z_{FB} = R_F \times \frac{1 + 2 \times \frac{R_S}{R_L} + \frac{R_S}{R_P}}{1 + 2 \times \frac{R_S}{R_L} + \frac{R_S}{R_P} - \frac{R_F}{R_P}} \tag{16}$$

To increase the 0.1-dB flatness to the frequency of interest, adding a serial RC in parallel with the gain resistor may be needed, as shown in Figure 87.

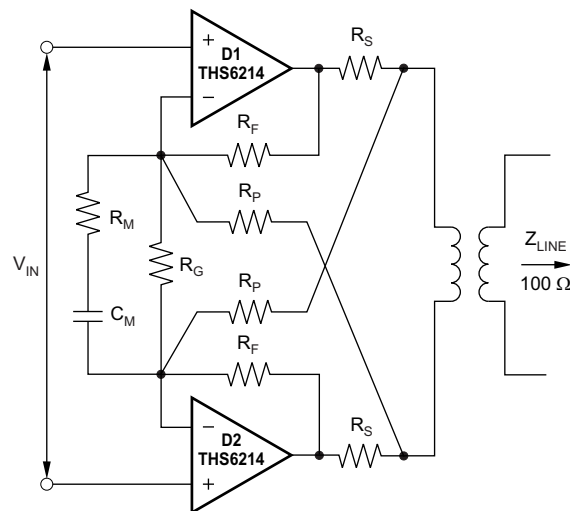

Figure 87. 0.1-dB Flatness Compensation Circuit

8.2.2.2.2 Total Driver Power for xDSL Applications

The total internal power dissipation for the THS6214 in an xDSL line driver application is the sum of the quiescent power and the output stage power. The THS6214 holds a relatively constant quiescent current versus supply voltage—giving a power contribution that is simply the quiescent current times the supply voltage used (the supply voltage is greater than the solution given in Equation 15). The total output stage power can be computed with reference to Figure 88.

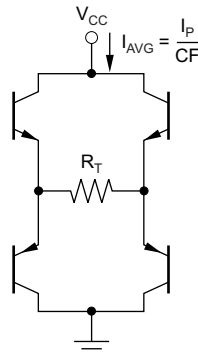

Figure 88. Output Stage Power Model

The two output stages used to drive the load of Figure 85 are shown as an H-Bridge in Figure 88. The average current drawn from the supply into this H-Bridge and load is the peak current in the load given by Equation 13 divided by the crest factor (CF) for the xDSL modulation. This total power from the supply is then reduced by the power in RT, leaving the power dissipated internal to the drivers in the four output stage transistors. That power is simply the target line power used in Equation 8 plus the power lost in the matching elements (RM). In the following examples, a perfect match is targeted giving the same power in the matching elements as in the load. The output stage power is then set by Equation 17.

$$P_{OUT} = \frac{I_P}{CF} \times V_{CC} - 2P_L \tag{17}$$

The total amplifier power is then given by Equation 18:

$$P_{TOT} = I_Q \times V_{CC} + \frac{I_P}{CF} \times V_{CC} - 2P_L \tag{18}$$

For the ADSL CO driver design of Figure 84, the peak current is 159 mA for a signal that requires a crest factor of 5.6 with a target line power of 20.5 dBm into a 100-Ω load (115 mW).

With a typical quiescent current of 21 mA and a nominal supply voltage of ±12 V, the total internal power dissipation for the solution of Figure 84 is given by Equation 19:

$$P_{TOT} = 21 \text{ mA} (24 \text{ V}) + \frac{159 \text{ mA}}{5.6} (24 \text{ V}) - 2(115 \text{ mW}) = 955 \text{ mW} \tag{19}$$

9 Power Supply Recommendations

The THS6214 is designed to operate optimally using split power supplies. The device has a very wide supply range of ±5 V to ±14 V to accommodate many different application scenarios. Choose power-supply voltages that allow for adequate swing on both the inputs and outputs of the amplifier to prevent affecting device performance. The ground pin provides the ground reference for the control pins and must be within VS- to (VS+ – 5 V) for proper operation.

10 Layout

10.1 Board Layout Guidelines

Achieving optimum performance with a high-frequency amplifier such as the THS6214 requires careful attention to board layout parasitic and external component types. Recommendations that optimize performance include:

- a. Minimize parasitic capacitance to any ac ground for all signal I/O pins. Parasitic capacitance on the output and inverting input pins can cause instability; on the noninverting input, this capacitance can react with the source impedance to cause unintentional band limiting. To reduce unwanted capacitance, a window around the signal I/O pins must be opened in all ground and power planes around these pins. Otherwise, ground and power planes must be unbroken elsewhere on the board.
- b. Minimize the distance (less than 0.25 in, or 6.35 mm) from the power-supply pins to high-frequency 0.1- μ F decoupling capacitors. At the device pins, the ground and power plane layout must not be in close proximity to the signal I/O pins. Avoid narrow power and ground traces to minimize inductance between the pins and the decoupling capacitors. The power-supply connections must always be decoupled with these capacitors. An optional supply decoupling capacitor across the two power supplies (for bipolar operation) improves second-harmonic distortion performance. Larger (2.2 μ F to 6.8 μ F) decoupling capacitors, effective at lower frequencies, must also be used on the main supply pins. These capacitors can be placed somewhat farther from the device and can be shared among several devices in the same area of the PCB.
- c. Careful selection and placement of external components preserve the high-frequency performance of the THS6214. Resistors must be of a very low reactance type. Surface-mount resistors work best and allow a tighter overall layout. Metal film and carbon composition, axially-leaded resistors can also provide good high-frequency performance.

Again, keep leads and PCB trace length as short as possible. Never use wire-wound type resistors in a high-frequency application. Although the output pin and inverting input pin are the most sensitive to parasitic capacitance, always position the feedback and series output resistor, if any, as close as possible to the output pin. Other network components, such as noninverting input termination resistors, must also be placed close to the package. Where double-side component mounting is allowed, place the feedback resistor directly under the package on the other side of the board between the output and inverting input pins. The frequency response is primarily determined by the feedback resistor value as described previously. Increasing the value reduces the bandwidth, whereas decreasing the value leads to a more peaked frequency response. The 1.24-k Ω feedback resistor used in the [Typical Characteristics](#) at a gain of 10 V/V on ± 12 -V supplies is a good starting point for design. Note that a 1.5-k Ω feedback resistor, rather than a direct short, is recommended for a unity-gain follower application. A current-feedback op amp requires a feedback resistor to control stability even in the unity-gain follower configuration.

- d. Connections to other wideband devices on the board can be made with short direct traces or through onboard transmission lines. For short connections, consider the trace and the input to the next device as a lumped capacitive load. Relatively wide traces (50 mils to 100 mils [0.050 in to 0.100 in, or 1.27 mm to 2.54 mm]) must be used, preferably with ground and power planes opened up around them. Estimate the total capacitive load and set R_S from the recommended R_S versus capacitive load plots (see [Figure 5](#), [Figure 23](#), [Figure 35](#), [Figure 47](#), [Figure 60](#), and [Figure 72](#)). Low parasitic capacitive loads (less than 5 pF) may not need an isolation resistor because the THS6214 is nominally compensated to operate with a 2-pF parasitic load. If a long trace is required, and the 6-dB signal loss intrinsic to a doubly-terminated transmission line is acceptable, implement a matched-impedance transmission line using microstrip or stripline techniques (consult an ECL design handbook for microstrip and stripline layout techniques). A 50- Ω environment is not necessary on board; in fact, a higher impedance environment improves distortion (see the distortion versus load plots). With a characteristic board trace impedance defined based on board material and trace dimensions, a matching series resistor into the trace from the output of the THS6214 is used, as well as a terminating shunt resistor at the input of the destination device. Remember also that the terminating impedance is the parallel combination of the shunt resistor and the input impedance of the destination device.

This total effective impedance must be set to match the trace impedance. The high output voltage and current capability of the THS6214 allows multiple destination devices to be handled as separate transmission lines, each with their own series and shunt terminations. If the 6-dB attenuation of a doubly-terminated transmission line is unacceptable, a long trace can be series-terminated at the source end only.

Board Layout Guidelines (continued)

Treat the trace as a capacitive load in this case and set the series resistor value as shown in the recommended R_S versus capacitive load plots. However, this configuration does not preserve signal integrity as well as a doubly-terminated line. If the input impedance of the destination device is low, there is some signal attenuation as a result of the voltage divider formed by the series output into the terminating impedance.

- e. Socketing a high-speed part such as the THS6214 is not recommended. The additional lead length and pin-to-pin capacitance introduced by the socket can create an extremely troublesome parasitic network, and can make achieving a smooth, stable frequency response almost impossible. Best results are obtained by soldering the THS6214 directly onto the board.
- f. Use the $-V_S$ plane to conduct heat out of the VQFN-24 and HTSSOP-24 PowerPAD packages. These packages attach the die directly to an exposed thermal pad on the bottom, and must be soldered to the board. This pad must be connected electrically to the same voltage plane as the most negative supply applied to the THS6214 (in Figure 84, this supply is -12 V).

10.2 Layout Example

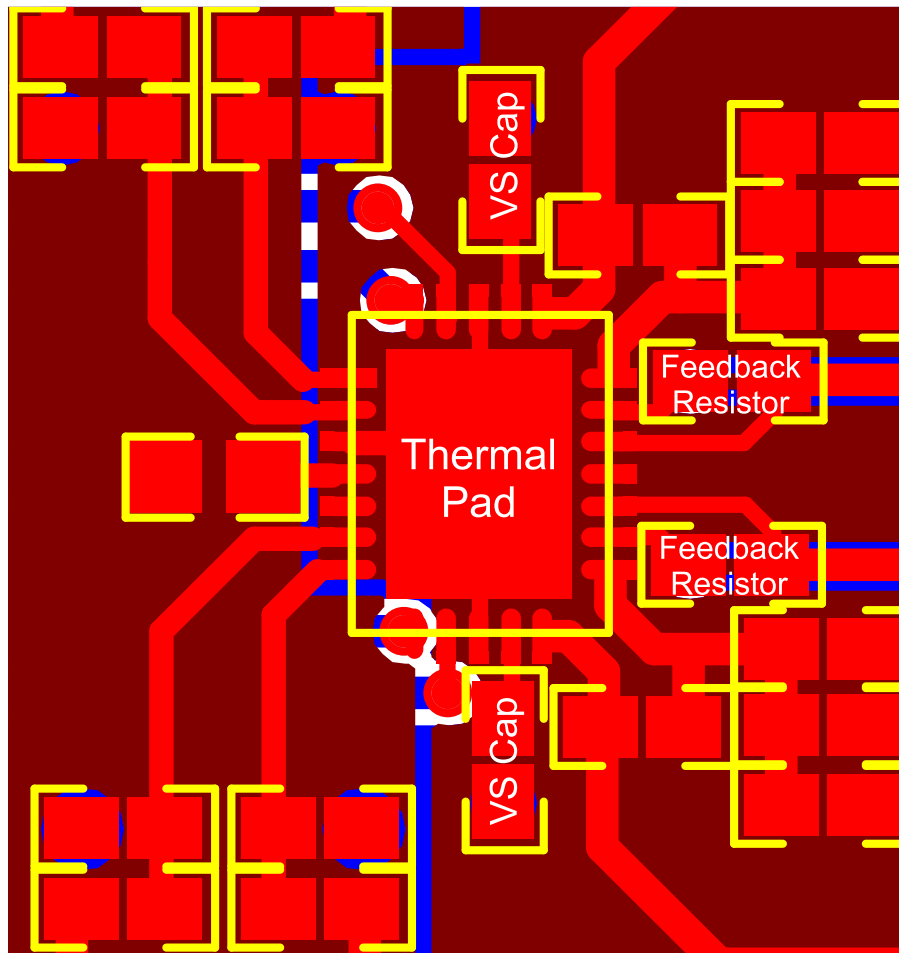

Figure 89. Example Layout

11 Device and Documentation Support

11.1 Receiving Notification of Documentation Updates

To receive notification of documentation updates, navigate to the device product folder on ti.com. In the upper right corner, click on *Alert me* to register and receive a weekly digest of any product information that has changed. For change details, review the revision history included in any revised document.

11.2 Community Resources

The following links connect to TI community resources. Linked contents are provided "AS IS" by the respective contributors. They do not constitute TI specifications and do not necessarily reflect TI's views; see TI's [Terms of Use](#).

TI E2E™ Online Community *TI's Engineer-to-Engineer (E2E) Community*. Created to foster collaboration among engineers. At e2e.ti.com, you can ask questions, share knowledge, explore ideas and help solve problems with fellow engineers.

Design Support *TI's Design Support* Quickly find helpful E2E forums along with design support tools and contact information for technical support.

11.3 Trademarks

PowerPAD, E2E are trademarks of Texas Instruments.
All other trademarks are the property of their respective owners.

11.4 Electrostatic Discharge Caution



This integrated circuit can be damaged by ESD. Texas Instruments recommends that all integrated circuits be handled with appropriate precautions. Failure to observe proper handling and installation procedures can cause damage.

ESD damage can range from subtle performance degradation to complete device failure. Precision integrated circuits may be more susceptible to damage because very small parametric changes could cause the device not to meet its published specifications.

11.5 Glossary

[SLYZ022](#) — *TI Glossary*.

This glossary lists and explains terms, acronyms, and definitions.

12 Mechanical, Packaging, and Orderable Information

The following pages include mechanical, packaging, and orderable information. This information is the most current data available for the designated devices. This data is subject to change without notice and revision of this document. For browser-based versions of this data sheet, refer to the left-hand navigation.

PACKAGING INFORMATION

Orderable Device	Status (1)	Package Type	Package Drawing	Pins	Package Qty	Eco Plan (2)	Lead/Ball Finish (6)	MSL Peak Temp (3)	Op Temp (°C)	Device Marking (4/5)	Samples
THS6214IPWP	ACTIVE	HTSSOP	PWP	24	60	Green (RoHS & no Sb/Br)	CU NIPDAU	Level-2-260C-1 YEAR	-40 to 85	THS6214	Samples
THS6214IPWPR	ACTIVE	HTSSOP	PWP	24	2000	Green (RoHS & no Sb/Br)	CU NIPDAU	Level-2-260C-1 YEAR	-40 to 85	THS6214	Samples
THS6214IRHFR	ACTIVE	VQFN	RHF	24	3000	Green (RoHS & no Sb/Br)	CU NIPDAU CU NIPDAUAG	Level-2-260C-1 YEAR	-40 to 85	6214	Samples
THS6214IRHFT	ACTIVE	VQFN	RHF	24	250	Green (RoHS & no Sb/Br)	CU NIPDAU CU NIPDAUAG	Level-2-260C-1 YEAR	-40 to 85	6214	Samples

(1) The marketing status values are defined as follows:

ACTIVE: Product device recommended for new designs.

LIFEBUY: TI has announced that the device will be discontinued, and a lifetime-buy period is in effect.

NRND: Not recommended for new designs. Device is in production to support existing customers, but TI does not recommend using this part in a new design.

PREVIEW: Device has been announced but is not in production. Samples may or may not be available.

OBSELETE: TI has discontinued the production of the device.

(2) **RoHS:** TI defines "RoHS" to mean semiconductor products that are compliant with the current EU RoHS requirements for all 10 RoHS substances, including the requirement that RoHS substance do not exceed 0.1% by weight in homogeneous materials. Where designed to be soldered at high temperatures, "RoHS" products are suitable for use in specified lead-free processes. TI may reference these types of products as "Pb-Free".

RoHS Exempt: TI defines "RoHS Exempt" to mean products that contain lead but are compliant with EU RoHS pursuant to a specific EU RoHS exemption.

Green: TI defines "Green" to mean the content of Chlorine (Cl) and Bromine (Br) based flame retardants meet JS709B low halogen requirements of <=1000ppm threshold. Antimony trioxide based flame retardants must also meet the <=1000ppm threshold requirement.

(3) MSL, Peak Temp. - The Moisture Sensitivity Level rating according to the JEDEC industry standard classifications, and peak solder temperature.

(4) There may be additional marking, which relates to the logo, the lot trace code information, or the environmental category on the device.

(5) Multiple Device Markings will be inside parentheses. Only one Device Marking contained in parentheses and separated by a "-" will appear on a device. If a line is indented then it is a continuation of the previous line and the two combined represent the entire Device Marking for that device.

(6) Lead/Ball Finish - Orderable Devices may have multiple material finish options. Finish options are separated by a vertical ruled line. Lead/Ball Finish values may wrap to two lines if the finish value exceeds the maximum column width.

Important Information and Disclaimer:The information provided on this page represents TI's knowledge and belief as of the date that it is provided. TI bases its knowledge and belief on information provided by third parties, and makes no representation or warranty as to the accuracy of such information. Efforts are underway to better integrate information from third parties. TI has taken and

continues to take reasonable steps to provide representative and accurate information but may not have conducted destructive testing or chemical analysis on incoming materials and chemicals. TI and TI suppliers consider certain information to be proprietary, and thus CAS numbers and other limited information may not be available for release.

In no event shall TI's liability arising out of such information exceed the total purchase price of the TI part(s) at issue in this document sold by TI to Customer on an annual basis.

TAPE AND REEL INFORMATION

QUADRANT ASSIGNMENTS FOR PIN 1 ORIENTATION IN TAPE

*All dimensions are nominal

Device	Package Type	Package Drawing	Pins	SPQ	Reel Diameter (mm)	Reel Width W1 (mm)	A0 (mm)	B0 (mm)	K0 (mm)	P1 (mm)	W (mm)	Pin1 Quadrant
THS6214IPWPR	HTSSOP	PWP	24	2000	330.0	16.4	6.95	8.3	1.6	8.0	16.0	Q1
THS6214IRHFR	VQFN	RHF	24	3000	330.0	12.4	4.3	5.3	1.3	8.0	12.0	Q1
THS6214IRHFT	VQFN	RHF	24	250	180.0	12.4	4.3	5.3	1.3	8.0	12.0	Q1

TAPE AND REEL BOX DIMENSIONS



*All dimensions are nominal

Device	Package Type	Package Drawing	Pins	SPQ	Length (mm)	Width (mm)	Height (mm)
THS6214IPWPR	HTSSOP	PWP	24	2000	367.0	367.0	38.0
THS6214IRHFR	VQFN	RHF	24	3000	367.0	367.0	35.0
THS6214IRHFT	VQFN	RHF	24	250	210.0	185.0	35.0

MECHANICAL DATA

PWP (R-PDSO-G24)

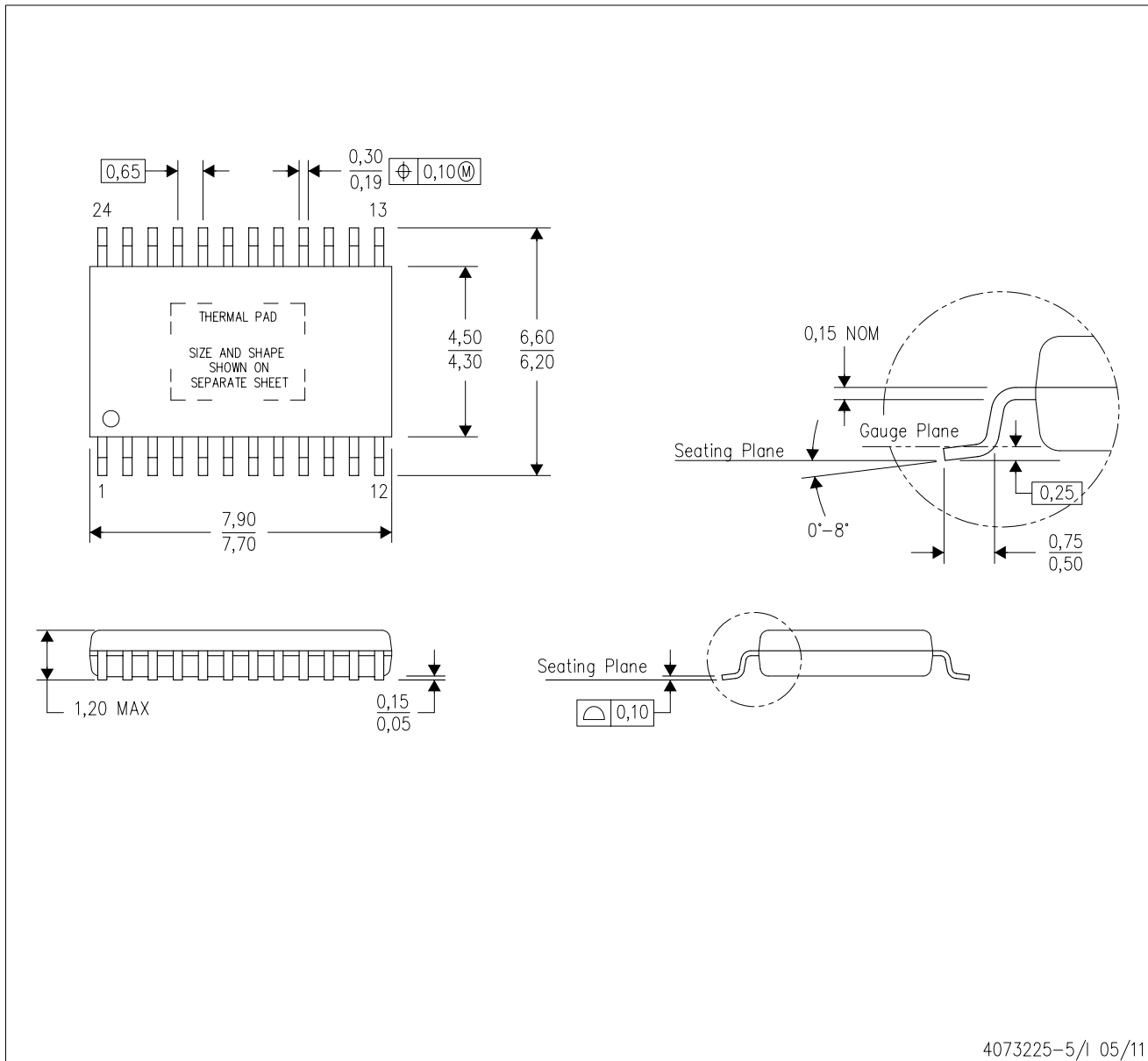
PowerPAD™ PLASTIC SMALL OUTLINE



- NOTES:
- All linear dimensions are in millimeters.
 - This drawing is subject to change without notice.
 - Body dimensions do not include mold flash or protrusions. Mold flash and protrusion shall not exceed 0.15 per side.
 - This package is designed to be soldered to a thermal pad on the board. Refer to Technical Brief, PowerPad Thermally Enhanced Package, Texas Instruments Literature No. SLMA002 for information regarding recommended board layout. This document is available at www.ti.com <<http://www.ti.com>>.
 - See the additional figure in the Product Data Sheet for details regarding the exposed thermal pad features and dimensions.
 - Falls within JEDEC MO-153

PowerPAD is a trademark of Texas Instruments.

THERMAL PAD MECHANICAL DATA

PWP (R-PDSO-G24) PowerPAD™ SMALL PLASTIC OUTLINE

THERMAL INFORMATION

This PowerPAD™ package incorporates an exposed thermal pad that is designed to be attached to a printed circuit board (PCB). The thermal pad must be soldered directly to the PCB. After soldering, the PCB can be used as a heatsink. In addition, through the use of thermal vias, the thermal pad can be attached directly to the appropriate copper plane shown in the electrical schematic for the device, or alternatively, can be attached to a special heatsink structure designed into the PCB. This design optimizes the heat transfer from the integrated circuit (IC).

For additional information on the PowerPAD package and how to take advantage of its heat dissipating abilities, refer to Technical Brief, PowerPAD Thermally Enhanced Package, Texas Instruments Literature No. SLMA002 and Application Brief, PowerPAD Made Easy, Texas Instruments Literature No. SLMA004. Both documents are available at www.ti.com.

The exposed thermal pad dimensions for this package are shown in the following illustration.

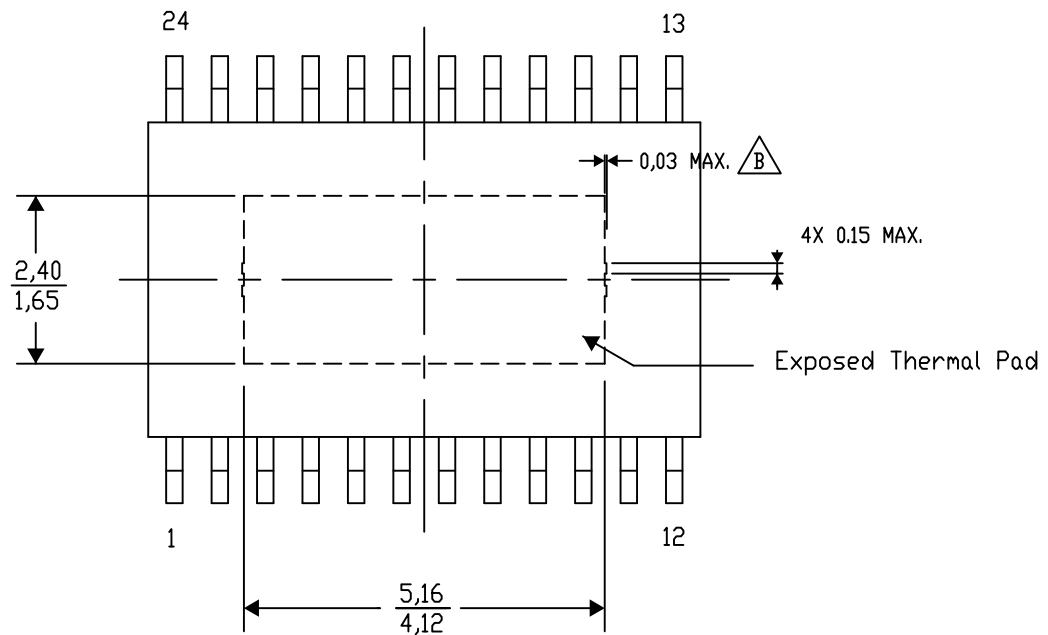

Top View

Exposed Thermal Pad Dimensions

4206332-29/AO 01/16

NOTE: A. All linear dimensions are in millimeters
B. Exposed tie strap features may not be present.

PowerPAD is a trademark of Texas Instruments

PWP (R-PDSO-G24)

PowerPAD™ PLASTIC SMALL OUTLINE

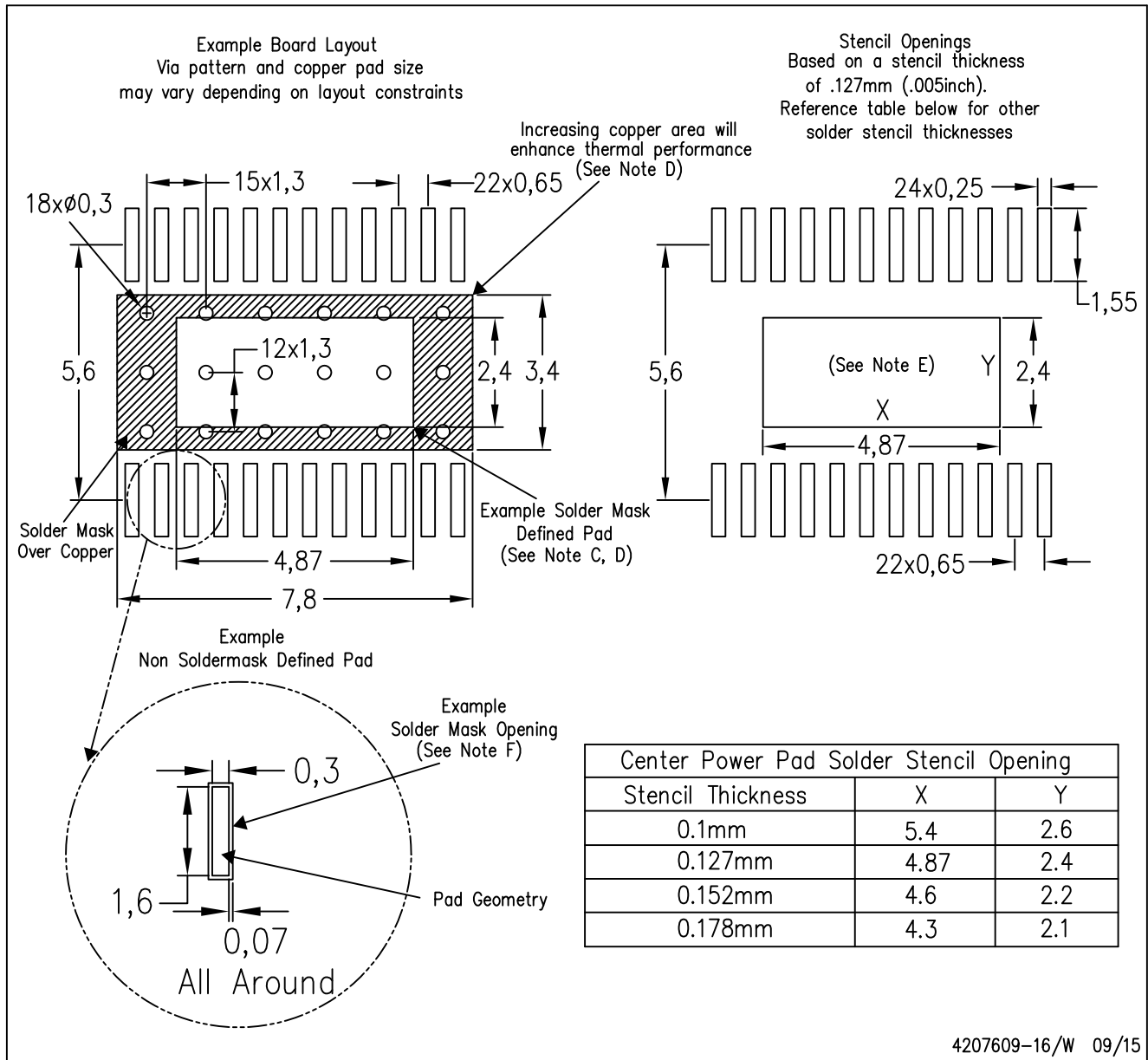

- NOTES:
- All linear dimensions are in millimeters.
 - This drawing is subject to change without notice.
 - Customers should place a note on the circuit board fabrication drawing not to alter the center solder mask defined pad.
 - This package is designed to be soldered to a thermal pad on the board. Refer to Technical Brief, PowerPad Thermally Enhanced Package, Texas Instruments Literature No. SLMA002, SLMA004, and also the Product Data Sheets for specific thermal information, via requirements, and recommended board layout. These documents are available at www.ti.com <<http://www.ti.com>>. Publication IPC-7351 is recommended for alternate designs.
 - Laser cutting apertures with trapezoidal walls and also rounding corners will offer better paste release. Customers should contact their board assembly site for stencil design recommendations. Example stencil design based on a 50% volumetric metal load solder paste. Refer to IPC-7525 for other stencil recommendations.
 - Customers should contact their board fabrication site for solder mask tolerances between and around signal pads.

MECHANICAL DATA

RHF (R-PVQFN-N24)

PLASTIC QUAD FLATPACK NO-LEAD

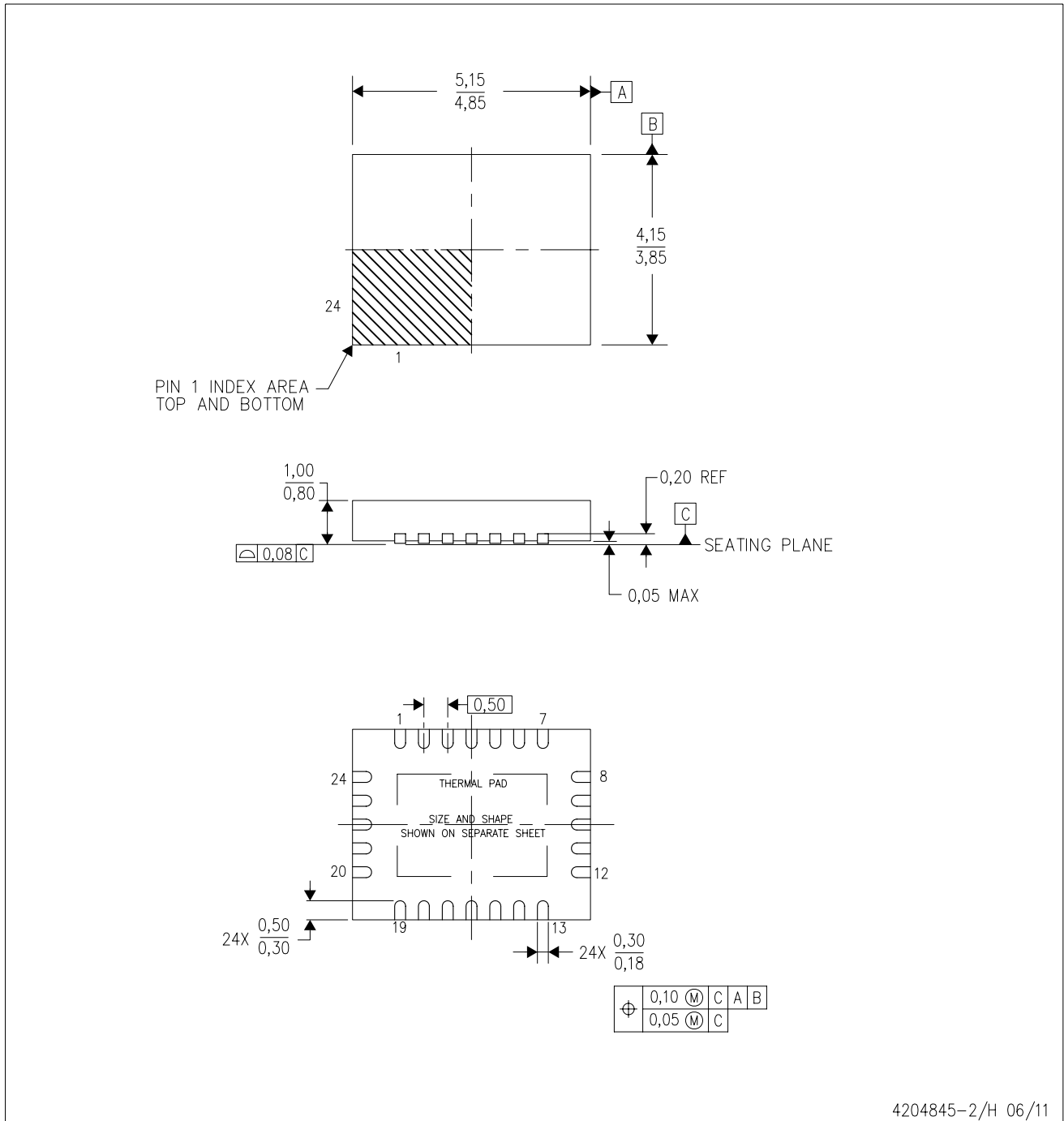

- NOTES:
- A. All linear dimensions are in millimeters. Dimensioning and tolerancing per ASME Y14.5M-1994.
 - B. This drawing is subject to change without notice.
 - C. QFN (Quad Flatpack No-Lead) Package configuration.
 - D. The package thermal pad must be soldered to the board for thermal and mechanical performance.
 - E. See the additional figure in the Product Data Sheet for details regarding the exposed thermal pad features and dimensions.
 - F. Falls within JEDEC MO-220.

THERMAL PAD MECHANICAL DATA

RHF (R-PVQFN-N24)

PLASTIC QUAD FLATPACK NO-LEAD

THERMAL INFORMATION

This package incorporates an exposed thermal pad that is designed to be attached directly to an external heatsink. The thermal pad must be soldered directly to the printed circuit board (PCB). After soldering, the PCB can be used as a heatsink. In addition, through the use of thermal vias, the thermal pad can be attached directly to the appropriate copper plane shown in the electrical schematic for the device, or alternatively, can be attached to a special heatsink structure designed into the PCB. This design optimizes the heat transfer from the integrated circuit (IC).

For information on the Quad Flatpack No-Lead (QFN) package and its advantages, refer to Application Report, QFN/SON PCB Attachment, Texas Instruments Literature No. SLUA271. This document is available at www.ti.com.

The exposed thermal pad dimensions for this package are shown in the following illustration.

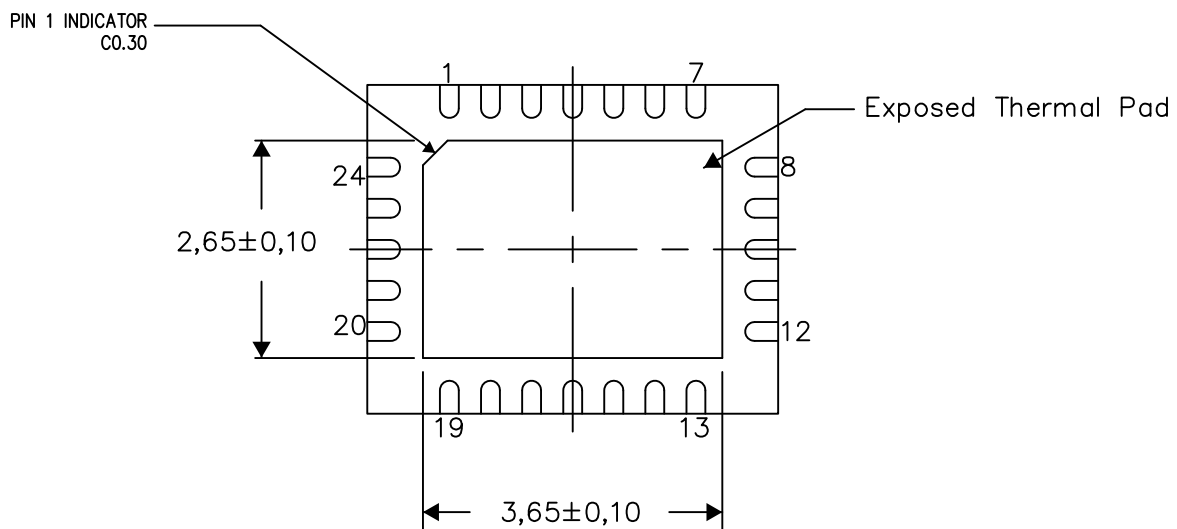

Bottom View

Exposed Thermal Pad Dimensions

4206360-3/K 02/14

NOTE: All linear dimensions are in millimeters

RHF (R-PVQFN-N24)

PLASTIC QUAD FLATPACK NO-LEAD

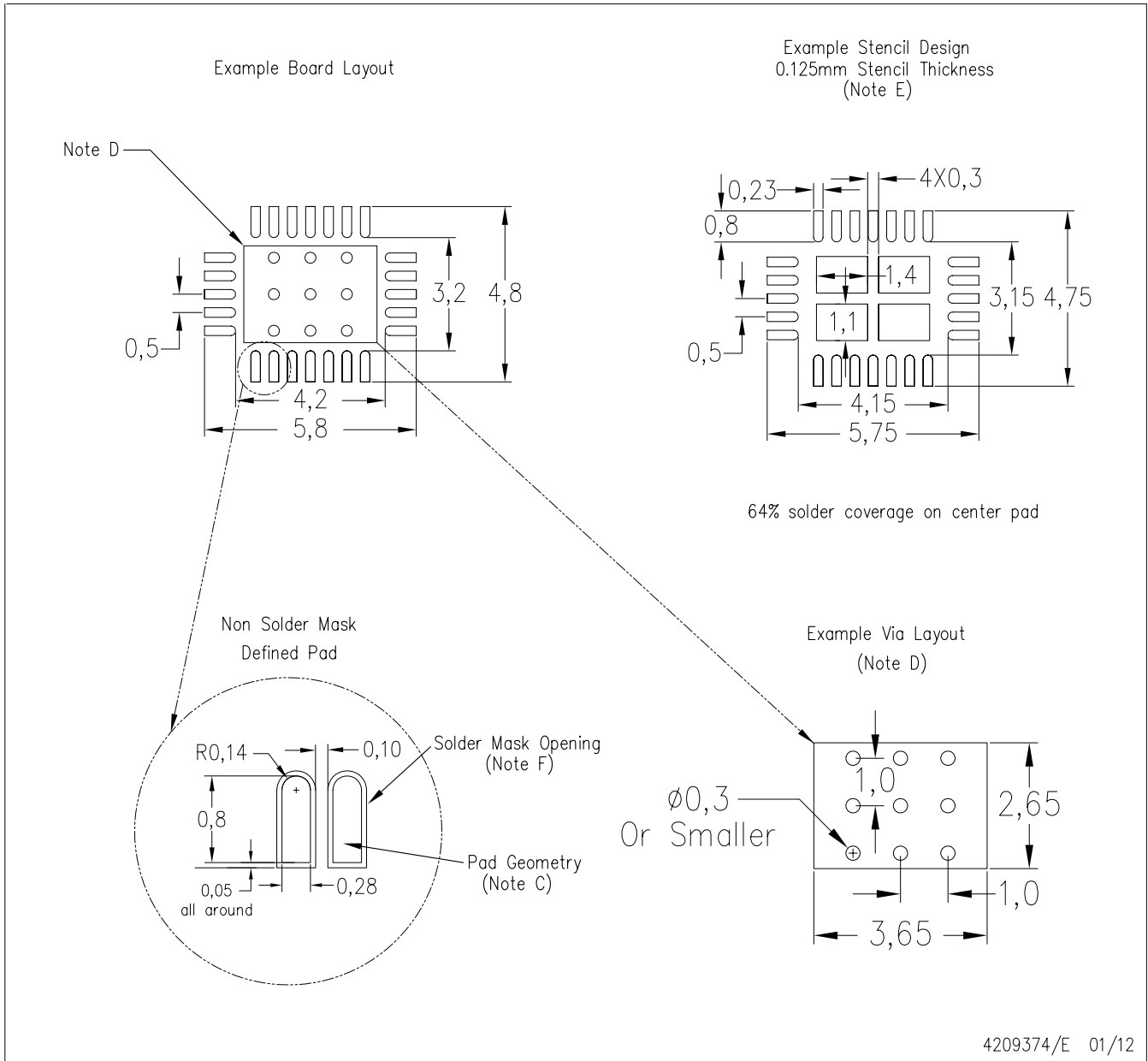

- NOTES:
- A. All linear dimensions are in millimeters.
 - B. This drawing is subject to change without notice.
 - C. Publication IPC-7351 is recommended for alternate designs.
 - D. This package is designed to be soldered to a thermal pad on the board. Refer to Application Note, Quad Flat-Pack Packages, Texas Instruments Literature No. SLUA271, and also the Product Data Sheets for specific thermal information, via requirements, and recommended board layout. These documents are available at www.ti.com <<http://www.ti.com>>.
 - E. Laser cutting apertures with trapezoidal walls and also rounding corners will offer better paste release. Customers should contact their board assembly site for stencil design recommendations. Refer to IPC 7525 for stencil design considerations.
 - F. Customers should contact their board fabrication site for recommended solder mask tolerances and via tenting recommendations for vias placed in thermal pad.

IMPORTANT NOTICE

Texas Instruments Incorporated (TI) reserves the right to make corrections, enhancements, improvements and other changes to its semiconductor products and services per JESD46, latest issue, and to discontinue any product or service per JESD48, latest issue. Buyers should obtain the latest relevant information before placing orders and should verify that such information is current and complete.

TI's published terms of sale for semiconductor products (<http://www.ti.com/sc/docs/stdterms.htm>) apply to the sale of packaged integrated circuit products that TI has qualified and released to market. Additional terms may apply to the use or sale of other types of TI products and services.

Reproduction of significant portions of TI information in TI data sheets is permissible only if reproduction is without alteration and is accompanied by all associated warranties, conditions, limitations, and notices. TI is not responsible or liable for such reproduced documentation. Information of third parties may be subject to additional restrictions. Resale of TI products or services with statements different from or beyond the parameters stated by TI for that product or service voids all express and any implied warranties for the associated TI product or service and is an unfair and deceptive business practice. TI is not responsible or liable for any such statements.

Buyers and others who are developing systems that incorporate TI products (collectively, "Designers") understand and agree that Designers remain responsible for using their independent analysis, evaluation and judgment in designing their applications and that Designers have full and exclusive responsibility to assure the safety of Designers' applications and compliance of their applications (and of all TI products used in or for Designers' applications) with all applicable regulations, laws and other applicable requirements. Designer represents that, with respect to their applications, Designer has all the necessary expertise to create and implement safeguards that (1) anticipate dangerous consequences of failures, (2) monitor failures and their consequences, and (3) lessen the likelihood of failures that might cause harm and take appropriate actions. Designer agrees that prior to using or distributing any applications that include TI products, Designer will thoroughly test such applications and the functionality of such TI products as used in such applications.

TI's provision of technical, application or other design advice, quality characterization, reliability data or other services or information, including, but not limited to, reference designs and materials relating to evaluation modules, (collectively, "TI Resources") are intended to assist designers who are developing applications that incorporate TI products; by downloading, accessing or using TI Resources in any way, Designer (individually or, if Designer is acting on behalf of a company, Designer's company) agrees to use any particular TI Resource solely for this purpose and subject to the terms of this Notice.

TI's provision of TI Resources does not expand or otherwise alter TI's applicable published warranties or warranty disclaimers for TI products, and no additional obligations or liabilities arise from TI providing such TI Resources. TI reserves the right to make corrections, enhancements, improvements and other changes to its TI Resources. TI has not conducted any testing other than that specifically described in the published documentation for a particular TI Resource.

Designer is authorized to use, copy and modify any individual TI Resource only in connection with the development of applications that include the TI product(s) identified in such TI Resource. NO OTHER LICENSE, EXPRESS OR IMPLIED, BY ESTOPPEL OR OTHERWISE TO ANY OTHER TI INTELLECTUAL PROPERTY RIGHT, AND NO LICENSE TO ANY TECHNOLOGY OR INTELLECTUAL PROPERTY RIGHT OF TI OR ANY THIRD PARTY IS GRANTED HEREIN, including but not limited to any patent right, copyright, mask work right, or other intellectual property right relating to any combination, machine, or process in which TI products or services are used. Information regarding or referencing third-party products or services does not constitute a license to use such products or services, or a warranty or endorsement thereof. Use of TI Resources may require a license from a third party under the patents or other intellectual property of the third party, or a license from TI under the patents or other intellectual property of TI.

TI RESOURCES ARE PROVIDED "AS IS" AND WITH ALL FAULTS. TI DISCLAIMS ALL OTHER WARRANTIES OR REPRESENTATIONS, EXPRESS OR IMPLIED, REGARDING RESOURCES OR USE THEREOF, INCLUDING BUT NOT LIMITED TO ACCURACY OR COMPLETENESS, TITLE, ANY EPIDEMIC FAILURE WARRANTY AND ANY IMPLIED WARRANTIES OF MERCHANTABILITY, FITNESS FOR A PARTICULAR PURPOSE, AND NON-INFRINGEMENT OF ANY THIRD PARTY INTELLECTUAL PROPERTY RIGHTS. TI SHALL NOT BE LIABLE FOR AND SHALL NOT DEFEND OR INDEMNIFY DESIGNER AGAINST ANY CLAIM, INCLUDING BUT NOT LIMITED TO ANY INFRINGEMENT CLAIM THAT RELATES TO OR IS BASED ON ANY COMBINATION OF PRODUCTS EVEN IF DESCRIBED IN TI RESOURCES OR OTHERWISE. IN NO EVENT SHALL TI BE LIABLE FOR ANY ACTUAL, DIRECT, SPECIAL, COLLATERAL, INDIRECT, PUNITIVE, INCIDENTAL, CONSEQUENTIAL OR EXEMPLARY DAMAGES IN CONNECTION WITH OR ARISING OUT OF TI RESOURCES OR USE THEREOF, AND REGARDLESS OF WHETHER TI HAS BEEN ADVISED OF THE POSSIBILITY OF SUCH DAMAGES.

Unless TI has explicitly designated an individual product as meeting the requirements of a particular industry standard (e.g., ISO/TS 16949 and ISO 26262), TI is not responsible for any failure to meet such industry standard requirements.

Where TI specifically promotes products as facilitating functional safety or as compliant with industry functional safety standards, such products are intended to help enable customers to design and create their own applications that meet applicable functional safety standards and requirements. Using products in an application does not by itself establish any safety features in the application. Designers must ensure compliance with safety-related requirements and standards applicable to their applications. Designer may not use any TI products in life-critical medical equipment unless authorized officers of the parties have executed a special contract specifically governing such use. Life-critical medical equipment is medical equipment where failure of such equipment would cause serious bodily injury or death (e.g., life support, pacemakers, defibrillators, heart pumps, neurostimulators, and implantables). Such equipment includes, without limitation, all medical devices identified by the U.S. Food and Drug Administration as Class III devices and equivalent classifications outside the U.S.

TI may expressly designate certain products as completing a particular qualification (e.g., Q100, Military Grade, or Enhanced Product). Designers agree that it has the necessary expertise to select the product with the appropriate qualification designation for their applications and that proper product selection is at Designers' own risk. Designers are solely responsible for compliance with all legal and regulatory requirements in connection with such selection.

Designer will fully indemnify TI and its representatives against any damages, costs, losses, and/or liabilities arising out of Designer's non-compliance with the terms and provisions of this Notice.