

10.3 A 715G5246 PSU  
10-3-1 Power Circuit

A01 Power Circuit

A01

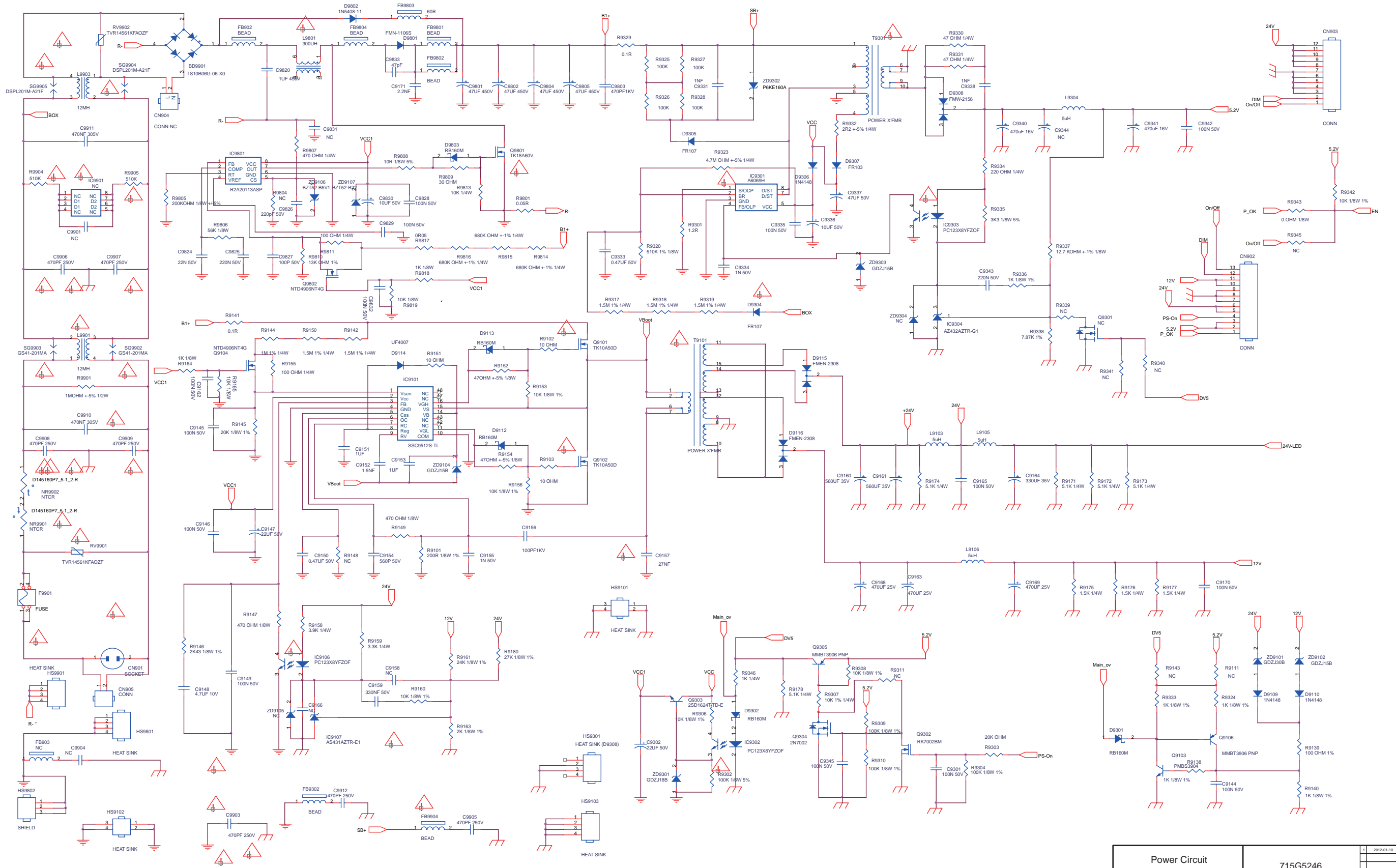

Power Circuit	715G5246	1	2012-01-10

A02

24 V to VLED

A02

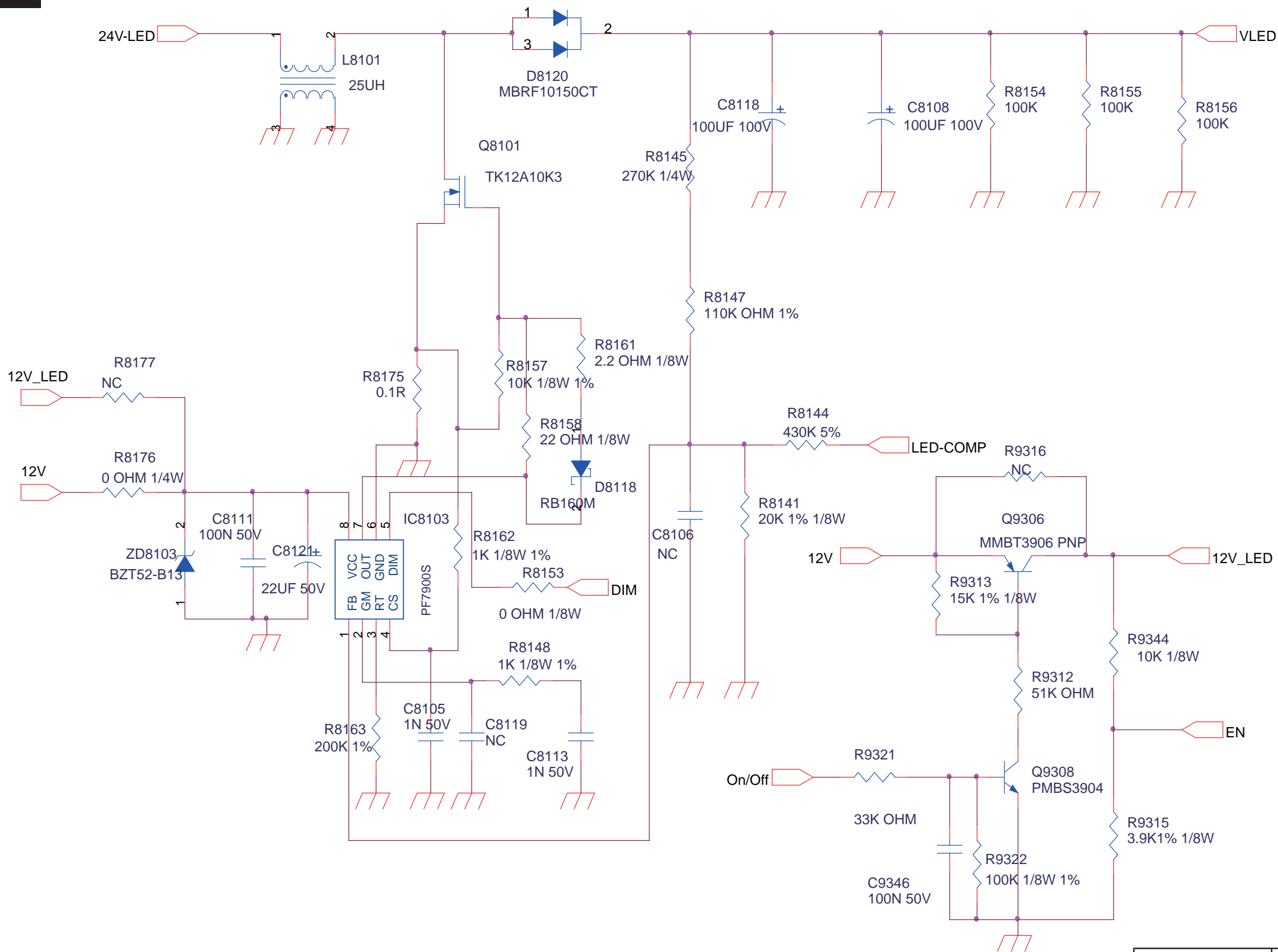

24 V to VLED	715G5246	1	2012-01-10

# A03

## LED Driver

# A03

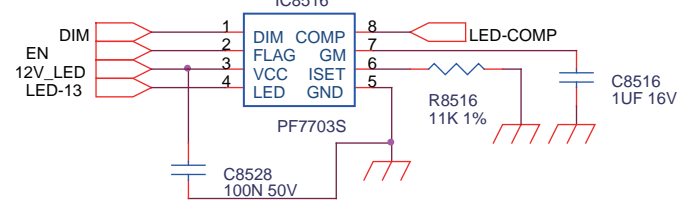
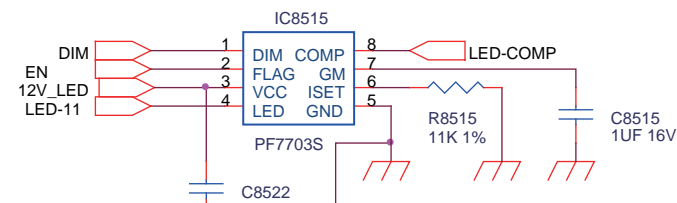
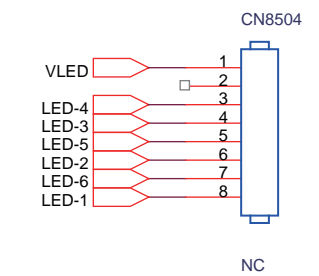
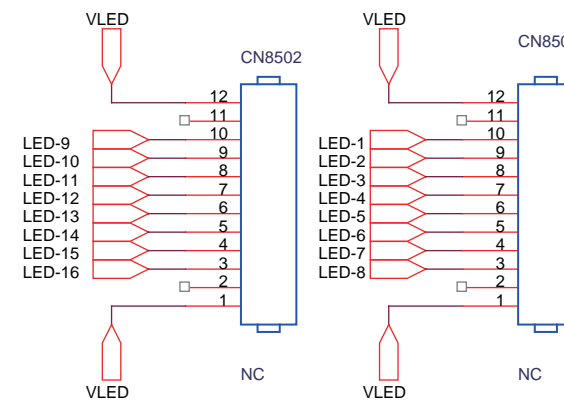
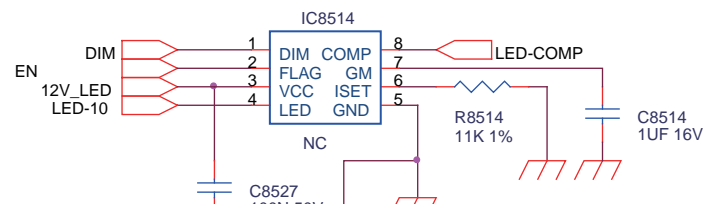
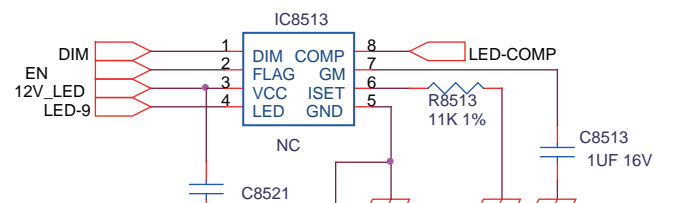
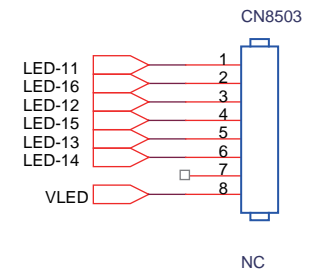
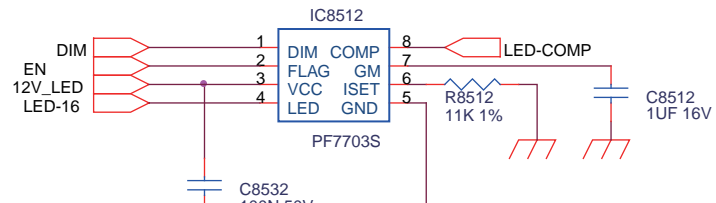
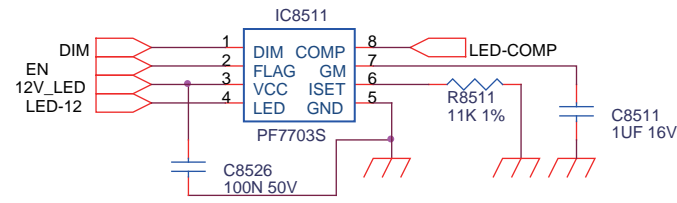
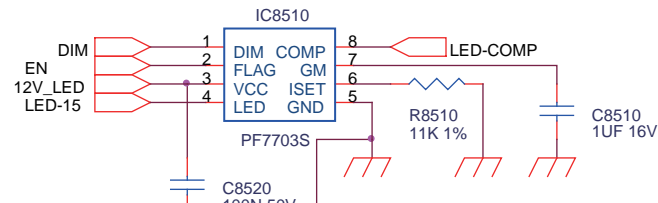
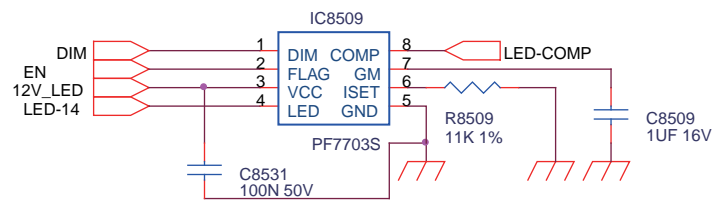
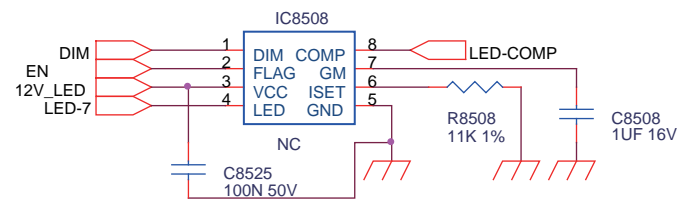
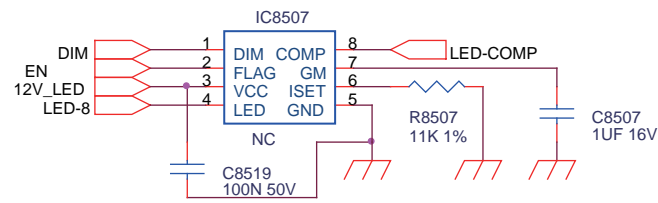
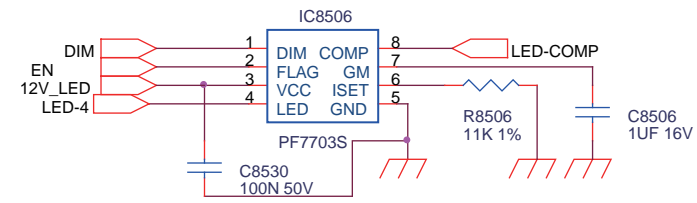
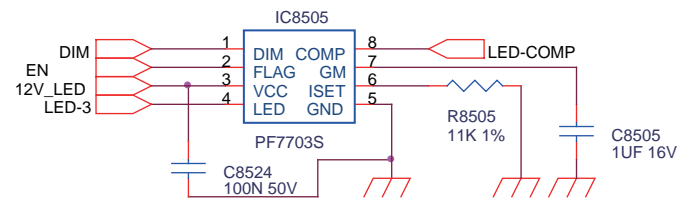
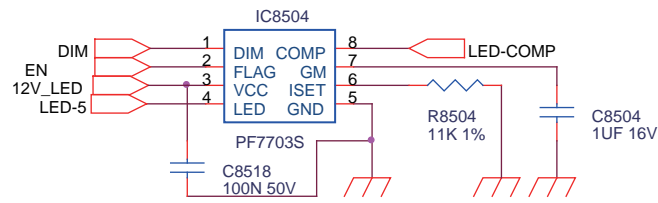
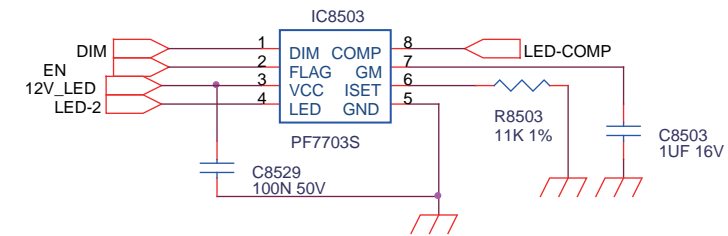
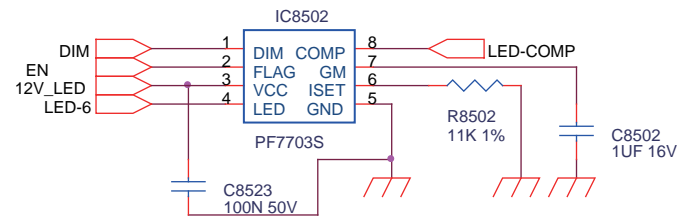
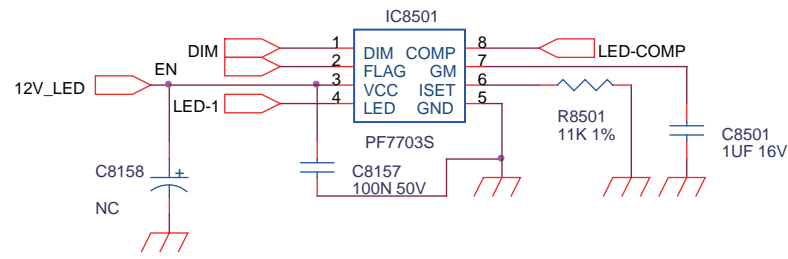

LED Driver	715G5246	1	2012-01-10

10-3-4 Power layout top

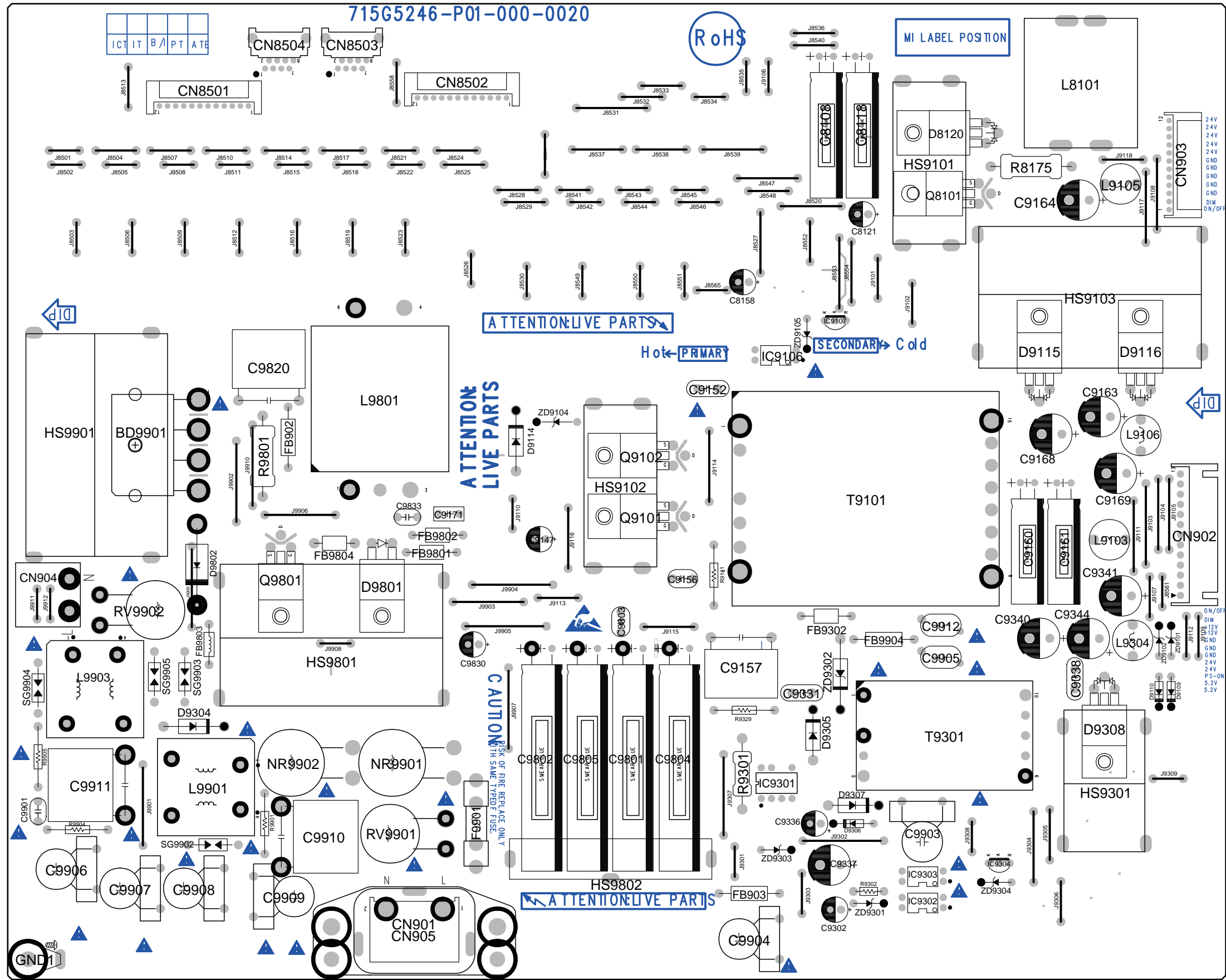

Power layout top	715G5246	1 2011-12-22
------------------	----------	--------------

10-3-5 Power layout bottom

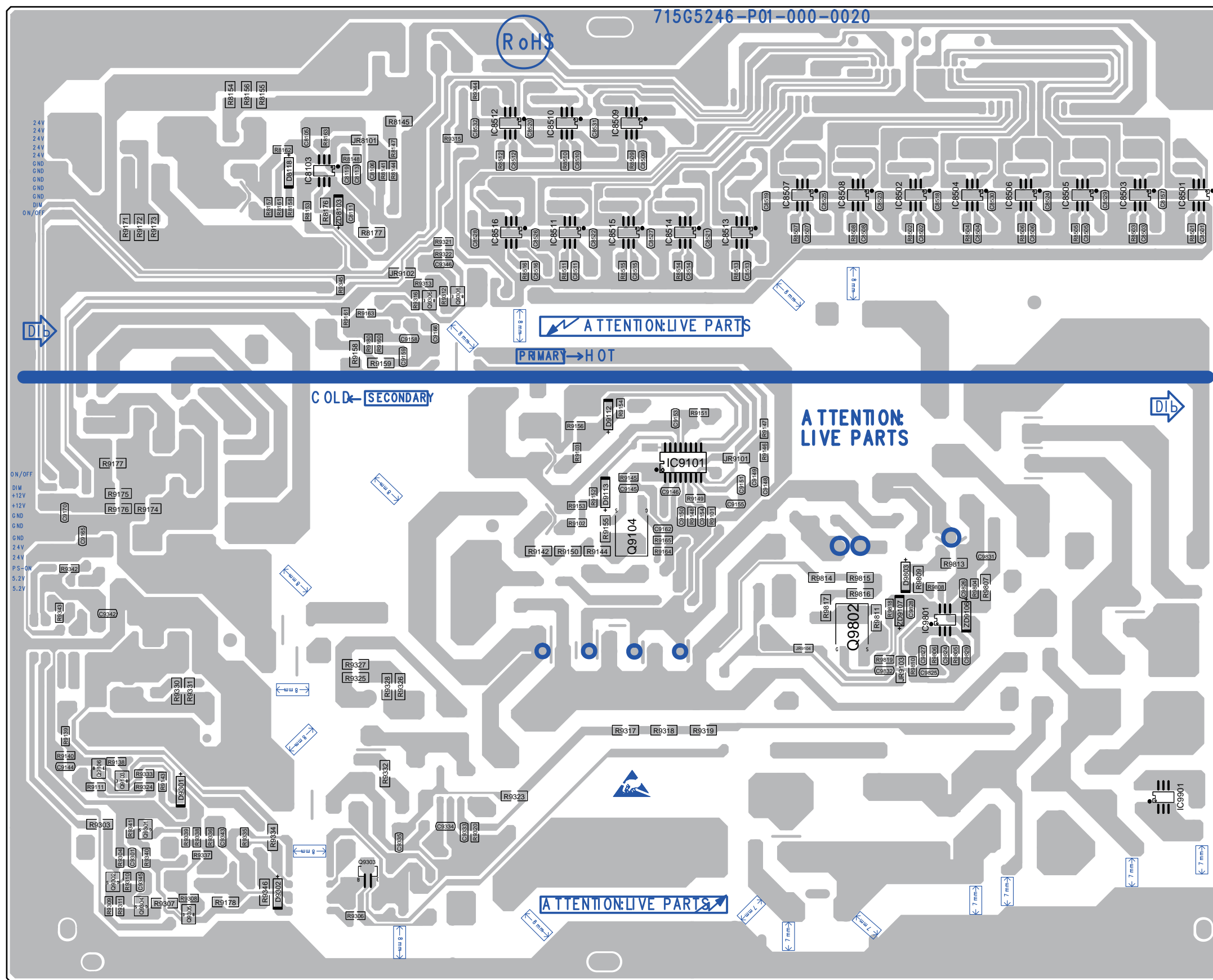

Power layout bottom	715G5246	1 2011-12-22