

HIH-4000 Series

Humidity Sensors

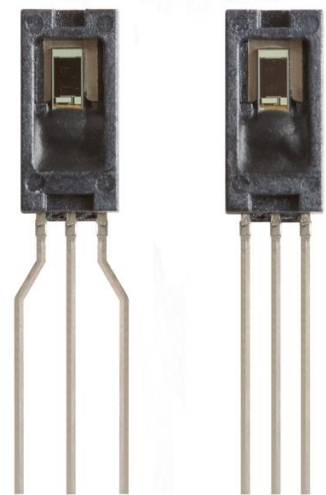

DESCRIPTION

The HIH-4000 Series Humidity Sensors are designed specifically for high volume OEM (Original Equipment Manufacturer) users.

Direct input to a controller or other device is made possible by this sensor's near linear voltage output. With a typical current draw of only 200 μ A, the HIH-4000 Series is often ideally suited for low drain, battery operated systems.

Tight sensor interchangeability reduces or eliminates OEM production calibration costs. Individual sensor calibration data is available.

FEATURES

- Molded thermoset plastic housing
- Near linear voltage output vs % RH
- Laser trimmed interchangeability
- Low power design
- Enhanced accuracy
- Fast response time
- Stable, low drift performance
- Chemically resistant

The HIH-4000 Series delivers instrumentation-quality RH (Relative Humidity) sensing performance in a competitively priced, solderable SIP (Single In-line Package).

Available in two lead spacing configurations, the RH sensor is a laser trimmed, thermoset polymer capacitive sensing element with on-chip integrated signal conditioning.

The sensing element's multilayer construction provides excellent resistance to most application hazards such as wetting, dust, dirt, oils and common environmental chemicals.

POTENTIAL APPLICATIONS

- Refrigeration equipment
- HVAC (Heating, Ventilation and Air Conditioning) equipment
- Medical equipment
- Drying
- Metrology
- Battery-powered systems
- OEM assemblies

HIH-4000 Series

Table 1. Performance Specifications (At 5 Vdc supply and 25 °C [77 °F] unless otherwise noted.)

Parameter	Minimum	Typical	Maximum	Unit	Specific Note
Interchangeability (first order curve)	–	–	–	–	–
0% RH to 59% RH	-5	–	5	% RH	–
60% RH to 100% RH	-8	–	8	% RH	–
Accuracy (best fit straight line)	-3.5	–	+3.5	% RH	1
Hysteresis	–	3	–	% RH	–
Repeatability	–	±0.5	–	% RH	–
Settling time	–	–	70	ms	–
Response time (1/e in slow moving air)	–	5	–	s	–
Stability (at 50% RH)	–	1.2	–	% RH	–
Voltage supply	4	–	5.8	Vdc	2
Current supply	–	200	500	µA	–
Voltage output (1 st order curve fit)	$V_{OUT} = (V_{SUPPLY})(0.0062(\text{sensor RH}) + 0.16)$, typical at 25 °C				
Temperature compensation	True RH = (Sensor RH)/(1.0546 – 0.00216T), T in °C				
Output voltage temperature, coefficient at 50% RH, 5 V	–	-4	–	mV/°C	–
Operating temperature	-40[-40]	See Figure 1.	85[185]	°C[°F]	–
Operating humidity	0	See Figure 1.	100	% RH	3
Storage temperature	-50[-58]	–	125[257]	°C[°F]	–
Storage humidity	See Figure 2.			% RH	3

Specific Notes:

- Can only be achieved with the supplied slope and offset.
For HIH-4000-003 and HIH-4000-004 catalog listings only.
- Device is calibrated at 5 Vdc and 25 °C.
- Non-condensing environment.

General Notes:

- Sensor is ratiometric to supply voltage.
- Extended exposure to ≥90% RH causes a reversible shift of 3% RH.
- Sensor is light sensitive. For best performance, shield sensor from bright light.

FACTORY CALIBRATION DATA

HIH-4000 Sensors may be ordered with a calibration and data printout. See Table 2 and the order guide on the back page.

Table 2. Example Data Printout

Model	HIH-4000-003
Channel	92
Wafer	030996M
MRP	337313
Calculated values at 5 V	
V _{OUT} at 0% RH	0.826 V
V _{OUT} at 75.3% RH	3.198 V
Linear output for 3.5% RH accuracy at 25 °C	
Zero offset	0.826 V
Slope	31.483 mV/%RH
RH	(V _{OUT} - zero offset)/slope (V _{OUT} - 0.826)/0.0315
Ratiometric response for 0% RH to 100% RH	
V _{OUT}	V _{SUPPLY} (0.1652 to 0.7952)



Humidity Sensors

Figure 1. Operating Environment (Non-condensing environment.)

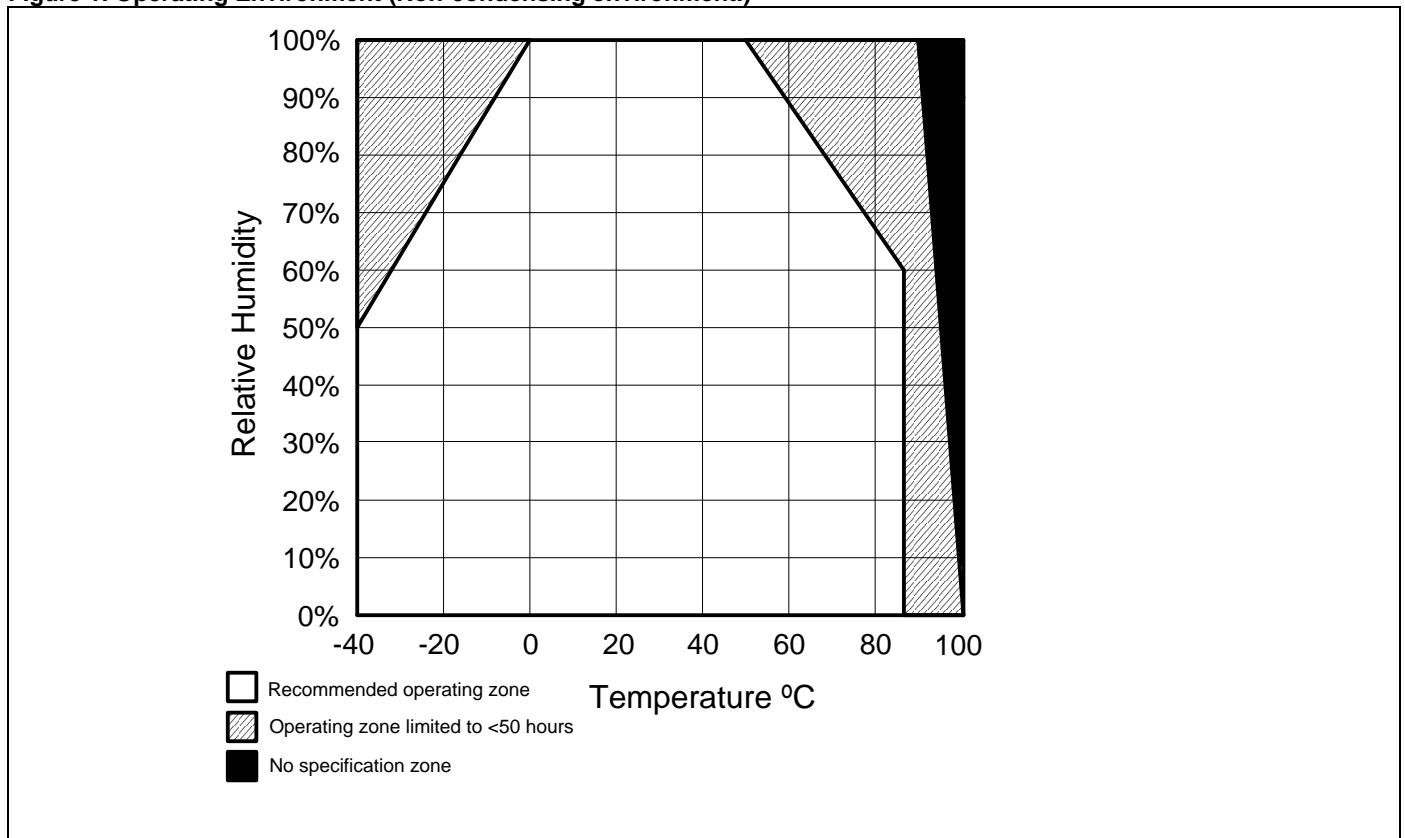
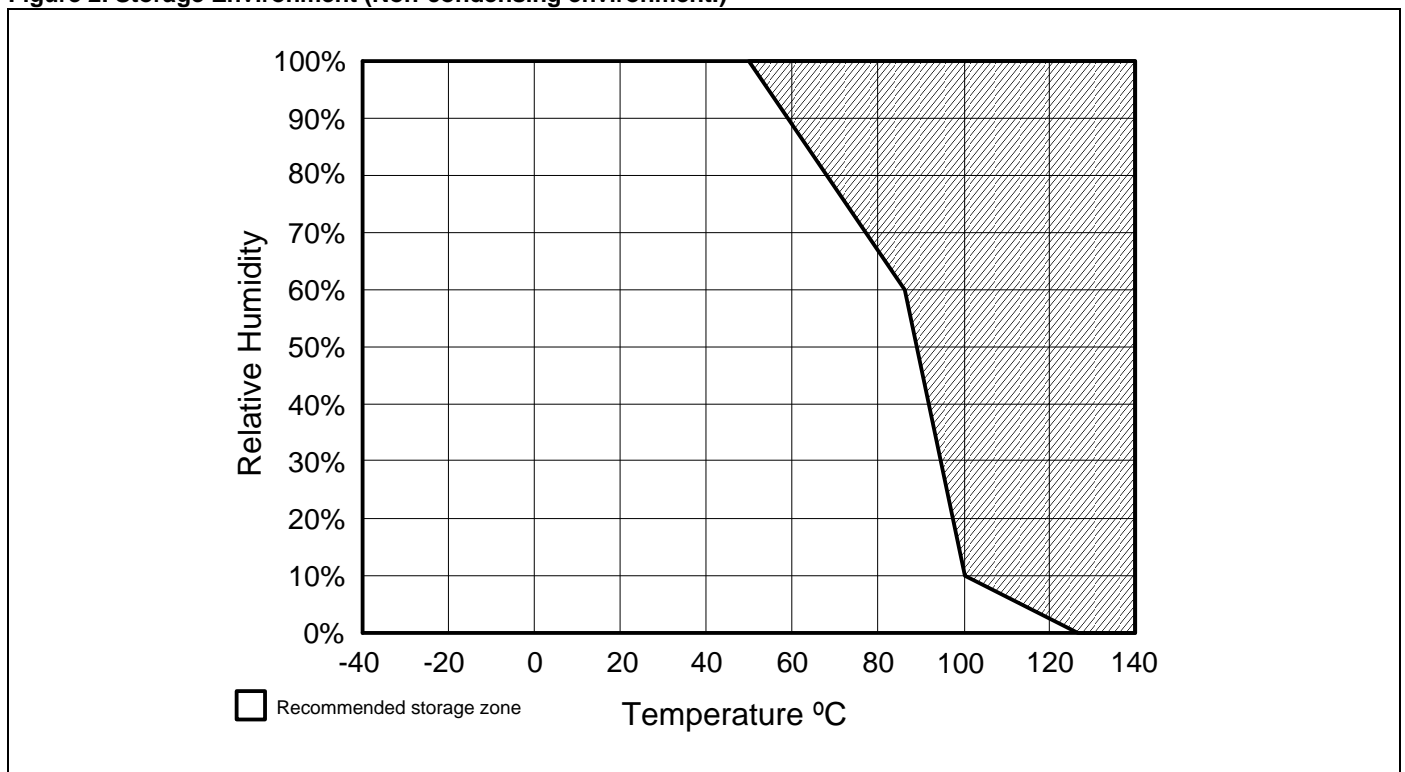

Figure 2. Storage Environment (Non-condensing environment.)



HIH-4000 Series

Figure 3. Typical Output Voltage vs Relative Humidity (At 25 °C and 5 V.)

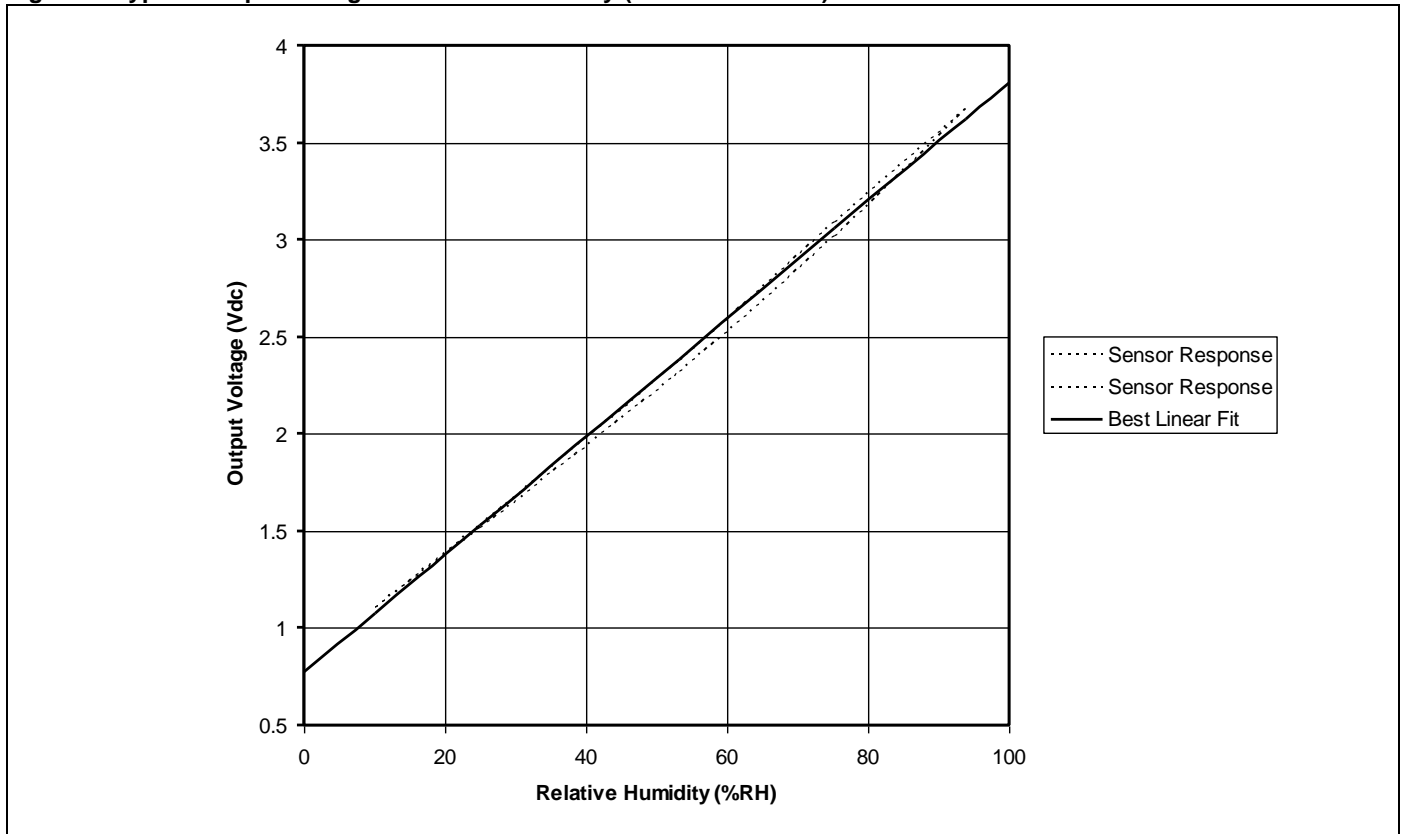
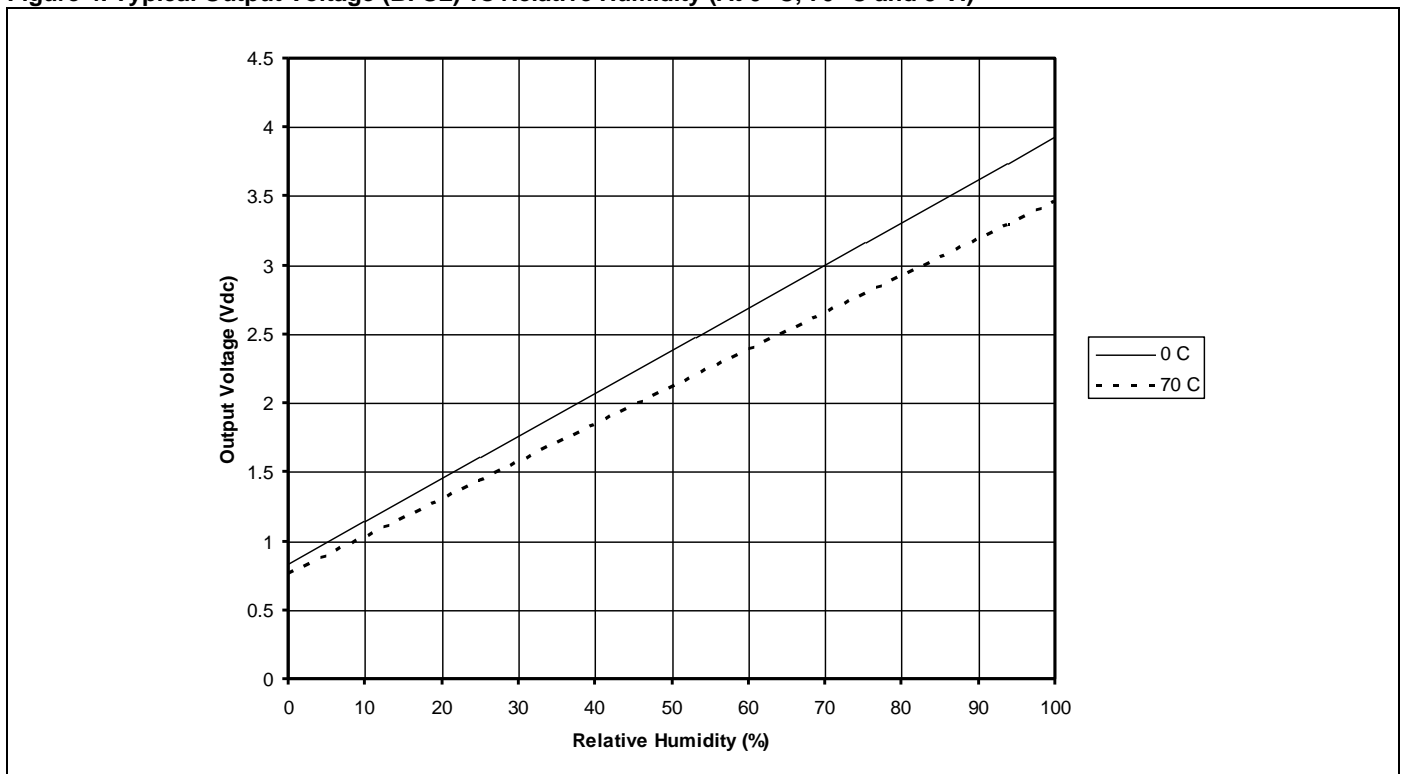

Figure 4. Typical Output Voltage (BFSL) vs Relative Humidity (At 0 °C, 70 °C and 5 V.)



Humidity Sensors

Figure 5. Mounting Dimensions (For reference only. mm/[in])

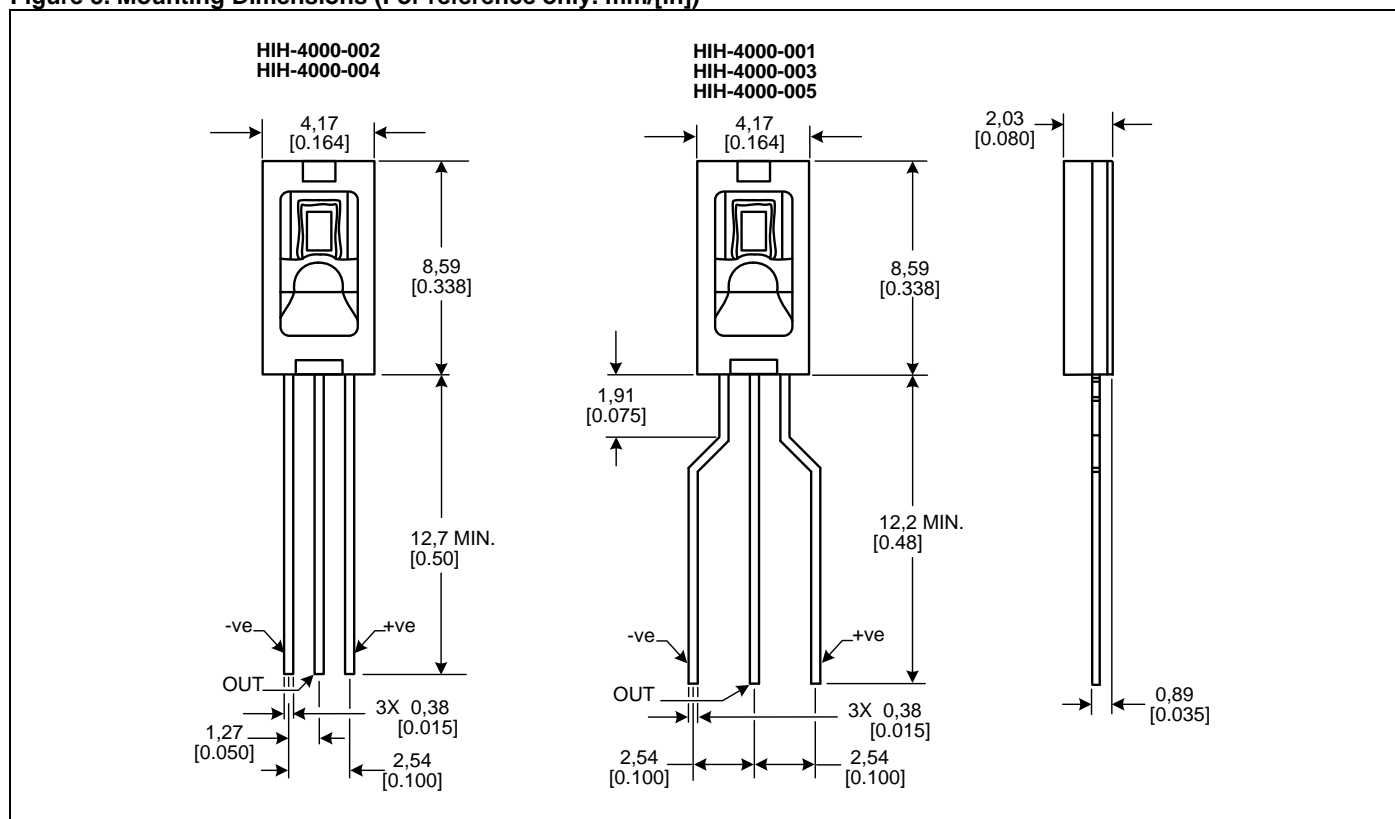
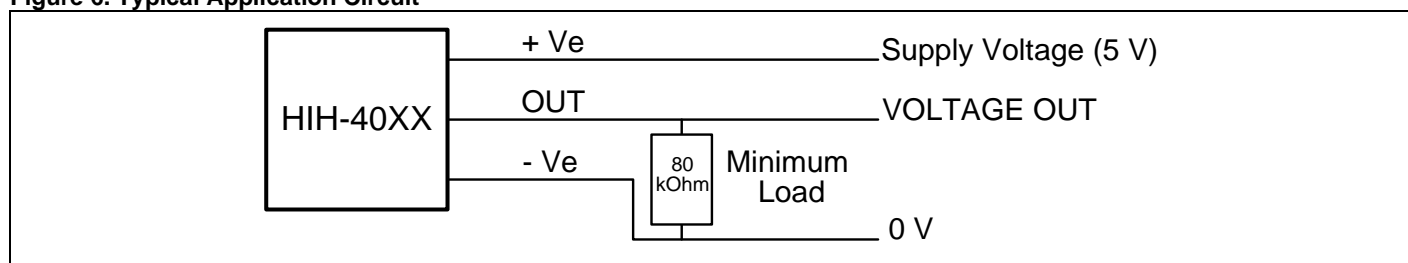

Figure 6. Typical Application Circuit



ORDER GUIDE

Catalog Listing	Description
HIH-4000-001	Integrated circuit humidity sensor, 2,54 mm [0.100 in] lead pitch SIP
HIH-4000-002	Integrated circuit humidity sensor, 1,27 mm [0.050 in] lead pitch SIP
HIH-4000-003	Integrated circuit humidity sensor, 2,54 mm [0.100 in] lead pitch SIP, calibration and data printout
HIH-4000-004	Integrated circuit humidity sensor, 1,27 mm [0.050 in] lead pitch SIP, calibration and data printout
HIH-4000-005	Equivalent to HIH-4000-001

ADDITIONAL HUMIDITY SENSOR INFORMATION

See the following associated literature at www.honeywell.com/sensing:

- Product installation instructions
- Application sheets:
 - Humidity Sensor Performance Characteristics
 - Humidity Sensor Theory and Behavior
 - Humidity Sensor Moisture and Psychrometrics
 - Thermoset Polymer-based Capacitive Sensors

WARNING

MISUSE OF DOCUMENTATION

- The information presented in this product sheet is for reference only. Do not use this document as a product installation guide.
- Complete installation, operation, and maintenance information is provided in the instructions supplied with each product.

Failure to comply with these instructions could result in death or serious injury.

WARRANTY/REMEDY

Honeywell warrants goods of its manufacture as being free of defective materials and faulty workmanship. Honeywell's standard product warranty applies unless agreed to otherwise by Honeywell in writing; please refer to your order acknowledgement or consult your local sales office for specific warranty details. If warranted goods are returned to Honeywell during the period of coverage, Honeywell will repair or replace, at its option, without charge those items it finds defective. **The foregoing is buyer's sole remedy and is in lieu of all other warranties, expressed or implied, including those of merchantability and fitness for a particular purpose. In no event shall Honeywell be liable for consequential, special, or indirect damages.**

While we provide application assistance personally, through our literature and the Honeywell web site, it is up to the customer to determine the suitability of the product in the application.

Specifications may change without notice. The information we supply is believed to be accurate and reliable as of this printing. However, we assume no responsibility for its use.

WARNING

PERSONAL INJURY

DO NOT USE these products as safety or emergency stop devices or in any other application where failure of the product could result in personal injury.

Failure to comply with these instructions could result in death or serious injury.

SALES AND SERVICE

Honeywell serves its customers through a worldwide network of sales offices, representatives and distributors. For application assistance, current specifications, pricing or name of the nearest Authorized Distributor, contact your local sales office or:

E-mail: info.sc@honeywell.com

Internet: www.honeywell.com/sensing

Phone and Fax:

Asia Pacific	+65 6355-2828 +65 6445-3033 Fax
Europe	+44 (0) 1698 481481 +44 (0) 1698 481676 Fax
Latin America	+1-305-805-8188 +1-305-883-8257 Fax
USA/Canada	+1-800-537-6945 +1-815-235-6847 +1-815-235-6545 Fax

Sensing and Control
Honeywell
1985 Douglas Drive North
Golden Valley, MN 55422
www.honeywell.com/sensing

009017-5-EN IL50 GLO Printed in USA
February 2010
© 2010 Honeywell International Inc. All rights reserved.

Honeywell