

NCR 5972 2x20 Customer Display

Release 2.0

User's Guide



BD20-1372-A
Issue F

The product described in this book is a licensed product of NCR Corporation.

NCR is a registered trademark of NCR Corporation.

It is the policy of NCR Corporation (NCR) to improve products as new technology, components, software, and firmware become available. NCR, therefore, reserves the right to change specifications without prior notice.

All features, functions, and operations described herein may not be marketed by NCR in all parts of the world. In some instances, photographs are of equipment prototypes. Therefore, before using this document, consult with your NCR representative or NCR office for information that is applicable and current.

To maintain the quality of our publications, we need your comments on the accuracy, clarity, organization, and value of this book.

Address correspondence to:

Manager, Information Products
NCR Corporation
2651 Satellite Blvd.
Duluth, GA 30096

Copyright © 1999
By NCR Corporation
Dayton, Ohio U.S.A.
All Rights Reserved

Preface

This manual is for hardware installer/service personnel, system integrators, field engineers, and programmers.

Safety Requirements

Warning: This device does not contain any user serviceable parts and should only be serviced by a qualified service technician.

Caution: This device should only be powered by a (SELV) Safety Extra Low Voltage power supply source with an available power level of 5 amperes or less, and suitable for the country of installation. The power source must be certified by the appropriate safety agency for the country of installation.

Le matériel doit être reliés électriquement au circuit à Très Basse Tension de Sécurité (TBTS) ayant une limite de 5 ampères correspondant de façon satisfaisante et acceptable dans le pays où le matériel doit être installé. Le source d'alimentation doit être approuvée par une agence de normalisation appropriée et acceptable dans le pays où le matériel doit être installé.

Caution: For continued protection against risk of fire, replace only with the same type and ratings of fuse.

Pour prévenir et vous protéger contre un risque de feu, remplacer la fusible avec une autre fusible de même type, seulement.

Caution: The power supply cord is used as the main disconnect device. Ensure that the socket outlet is located/installed near the equipment and is easily accessible.

Le cordon d'alimentation est utilisé comme interrupteur général. La prise de courant doit être située ou installée à proximité du matériel et être facile d'accès.

Table of Contents

Chapter 1: Introduction

Models	1-1
Features	1-1
VFD Models	1-1
Hardware	1-1
Software.....	1-2
LCD Models	1-3
Hardware	1-3
Software.....	1-3

Chapter 2: Site Preparation

Physical Environment	2-1
Working Range	2-1
Storage Environment	2-2
Transit Environment	2-2
Dimensions.....	2-3
VFD Models	2-3
LCD Models	2-6
Electrical Environment.....	2-7
VFD AC Power Requirements.....	2-7
VFD DC Power Requirements.....	2-7
LCD AC Power Requirements.....	2-7
LCD DC Power Requirements.....	2-7
Operational Environment.....	2-7
System Configuration	2-7
Mounting Hole Dimensions	2-8

Chapter 3: Installation

Installing the Customer Display 3-1

 SELV Power Source Warning 3-1

 Installation Goal..... 3-2

 Cable Requirements 3-2

 Power Supply Choices 3-3

 Installation Procedures 3-3

 NCR 5952/5962 Integrated Mount 3-3

 RS-232 Serial Interface 3-4

Diagnostics..... 3-5

 Micro-controller Test..... 3-5

 External Memory Test Character (VFD Only)..... 3-5

 Pixel Test..... 3-6

 Firmware Part Number Display..... 3-6

Chapter 4: Programming Set Up

Host/Retail Display Command Interface 4-1

Retail Display Commands 4-2

 Reset Display..... 4-4

 Erase Display..... 4-5

 Set Diagnostic State On..... 4-5

 Set Display State On..... 4-6

 Set Low Power State On 4-6

 Enable Cursor..... 4-7

 Disable Cursor 4-7

 Set Screen Save Blank..... 4-8

 Set Screen Save Walk 4-8

 Turn On Screen Save..... 4-9

 Disable Screen Save Option 4-9

Enable Character Blink	4-9
Disable Character Blink	4-10
Move Cursor Left.....	4-10
Move Cursor Right.....	4-10
Move Cursor Up	4-11
Move Cursor Down.....	4-11
Move Cursor To Specified Position	4-12
Brightness Adjustment	4-13
Read Display ID Byte.....	4-13
Read Display ID String.....	4-14
Display ESC Character.....	4-14
Select Character Set <i>n</i>	4-14
Character Sets	4-15
Code Page 850 (International)	4-15
Code Page Katakana	4-28
Code Page 866 (Cyrillic)	4-41

Chapter 5: Service

Safety Requirements.....	5-1
Servicing the Display.....	5-3
Normal Operation	5-3
Troubleshooting Procedures.....	5-3
Servicing the VFD or LCD.....	5-4
Cleaning the Display.....	5-6

Revision Record

Issue	Date	Remarks
A	Feb 97	First issue
B	Nov 98	Update to include 5972-1100
C	Mar 99	Added 5963 Integrated Display Mount
D	Jan 03	Removed 5972-2x00 model. Added dimension information.
E	Feb 03	Added character sets.
F	June 03	Added new LCD models

Radio Frequency Interference Statements

Federal Communications Commission (FCC)

Information to User

This equipment has been tested and found to comply with the limits for a Class A digital device, pursuant to Part 15 of FCC Rules. These limits are designed to provide reasonable protection against harmful interference when the equipment is operated in a commercial environment. This equipment generates, uses, and can radiate radio frequency energy and, if not installed and used in accordance with the instruction manual, may cause harmful interference to radio communications. Operation of this equipment in a residential area is likely to cause interference in which case the user will be required to correct the interference at his own expense.

NCR is not responsible for any radio or television interference caused by unauthorized modification of this equipment or the substitution or attachment of connecting cables and equipment other than those specified by NCR. The correction of interference caused by such unauthorized modification, substitution or attachment will be the responsibility of the user. The user is cautioned that changes or modifications not expressly approved by NCR may void the user's authority to operate the equipment.

Canadian Department of Communications

This digital apparatus does not exceed the Class A limits for radio noise emissions from digital apparatus set out in the Radio Interference Regulations of the Canadian Department of Communications.

Le présent appareil numérique n'émet pas de bruits radioélectriques dépassant les limites applicables aux appareils numériques de la classe A prescrites dans le Règlement sur le brouillage radioélectriques édicté par le ministère des Communications du Canada.

Voluntary Control Council For Interference (VCCI)

この装置は、情報処理装置等電波障害自主規制協議会（VCCI）の基準に基づくクラスA情報技術装置です。この装置を家庭環境で使用すると電波妨害を引き起こすことがあります。この場合には使用者が適切な対策を講ずるよう要求されることがあります。

Chapter 1: Introduction

Models

The NCR 5972 Customer Display is designed to be an optional display device for the NCR retail terminals. It can also serve as a display for any industry-standard PC. It is a Vacuum Fluorescent Display (VFD).

- 5972-1000 2x20 VFD (Light Gray)
- 5972-1100 2X20 VFD (Dark Gray, Low Post Mount)
- 5972-1200 2x20 VFD (Light Gray, Euro Symbol)
- 5972-1300 2x20 VFD (Dark Gray, Low Post Mount)
- 5972-1400 2x20 VFD (Charcoal Gray, Low Post Mount)
- 5972-2400 2x20 LCD (Light Gray, 1m Cable)
- 5972-2500 2x20 LCD (Light Gray, 4m Cable)

Features

VFD Models

Hardware

- Parallel I/F or EIA-232 I/F support
 - The components for both interfaces are populated on one printed circuit board. Both interfaces are active, though only one interface can be physically connected at a time. The display communicates via the interface connected to it.
- Socket for 32K of PROM for additional character sets
- Cables

- Power Supply
- Mounting Options
 - Table Mount, Light Gray, 16-in. Post
 - Table Mount, Light Gray, 8-in. Post
 - Table Mount, Light Gray, No Post
 - Remote Mount, 8-in. Post, Light Gray
 - Remote Mount, 8-in. Post, Dark Gray
 - Integrated Mount, Telescoping Post, Charcoal Gray for 7458
 - Integrated Mount, Telescoping Post, Light Gray for 5964
 - Integrated Mount, Telescoping Post, Light Gray
 - No Mount

Software

- VFD control of 7x9 pixel characters
- Parallel I/F
- EIA-232 Serial I/F (9600 BPS, 8 bit character, no parity, 1 stop bit)
- Diagnostics
- Support for 19 character sets
- 3 Character sets in base unit
 - Code Page 858 (International)
 - Katakana
 - Code Page 866 (Cyrillic)
- Socket allows for support of up to 16 additional character sets

LCD Models

Hardware

- Cables
- Power Supply
- Mounting Options
 - Table Mount, Light Gray, 16-in. Post
 - Table Mount, Light Gray, 8-in. Post
 - Table Mount, Light Gray, No Post
- Remote Mount, 8-in. Post, Light Gray
- Integrated Mount, Telescoping Post, Light Gray for 5964
- Integrated Mount, Telescoping Post, Light Gray
- No Mount

Software

- Powered RS-232 I/F
- Diagnostics
- 1 Character set in base unit
 - Code Page 858 (International)

Chapter 2: Site Preparation

This chapter describes the installation process including site considerations, operating conditions, mounting options, and connections.

Physical Environment

The working range, storage, and transit environments are presented in the following tables.

Working Range

Condition	Range
Temperature	10°C to 40°C (50°F to 104°F)
Temperature Change	10°C (18°F) / Hour
Humidity Range	20% to 80% (No Condensation)
Humidity Change	10% / hour
Barometric Pressure	105,000 Pa to 69000 Pa

Note: Condensation may occur when equipment is transferred from cold to warm areas during shipment. The equipment design shall permit operation after condensation has occurred, a drying out process has been accomplished, and the equipment stabilized to the operating environment.

Storage Environment

For periods up to three months:

Condition	Range
Temperature	-10°C to 50°C (14°F to 120°F)
Humidity	10% to 90% RH
Barometric Pressure	105,000 to 70,000 Pa

Transit Environment

For periods up to one week:

Condition	Range
Temperature	-40° to 60°C (-40°F to 140°F)
Humidity	5% to 95% RH
Barometric Pressure	105,000 to 70,000 Pa

Dimensions

VFD Models

Desktop Mount

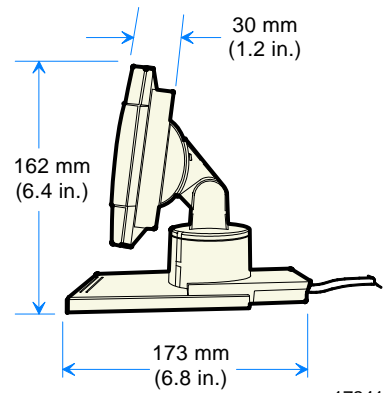
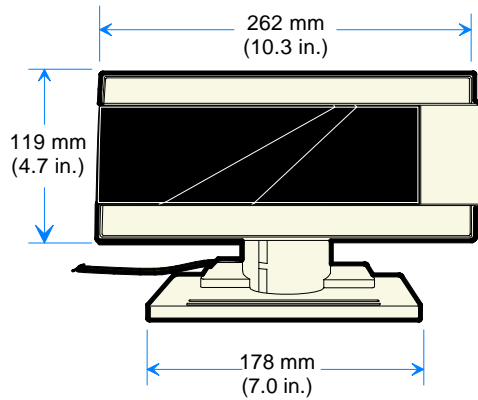
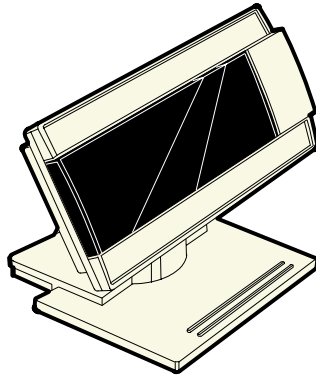

17241

16-Inch Post

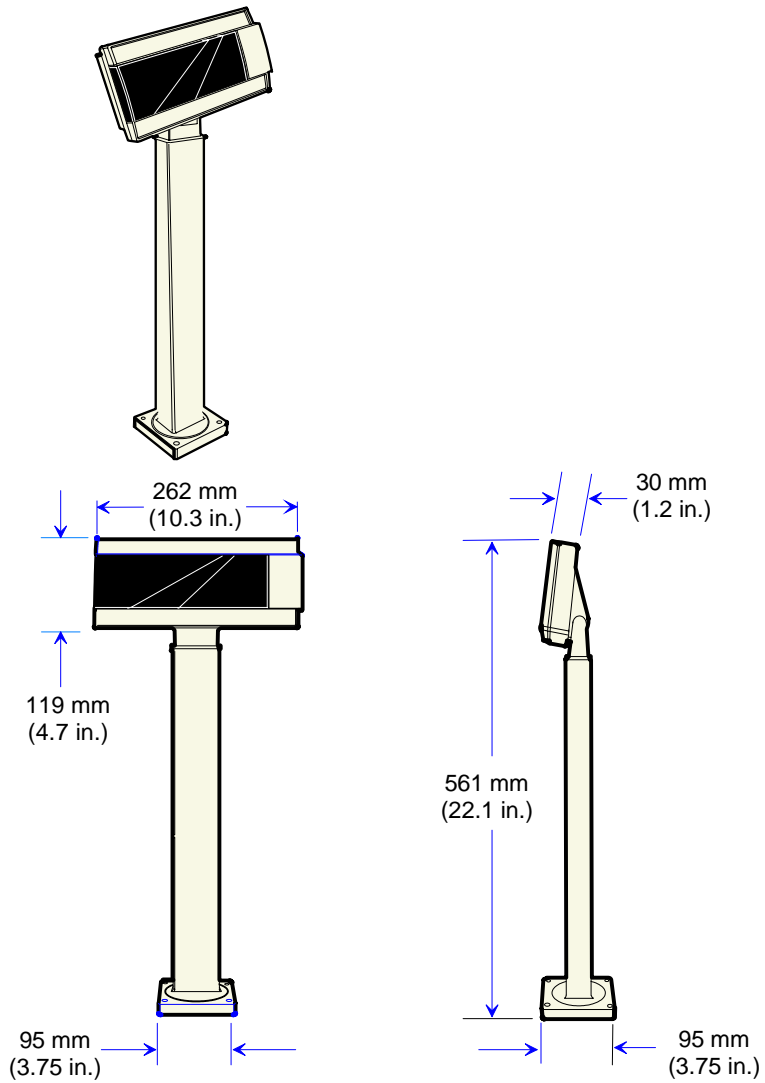

8-Inch Post

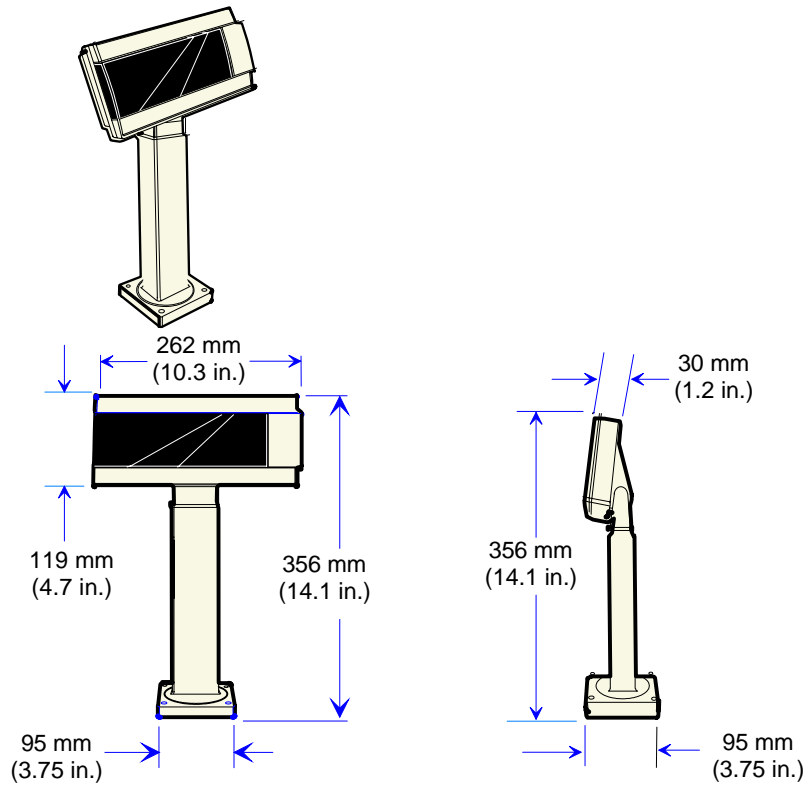

20131a

LCD Models

Desktop Mount

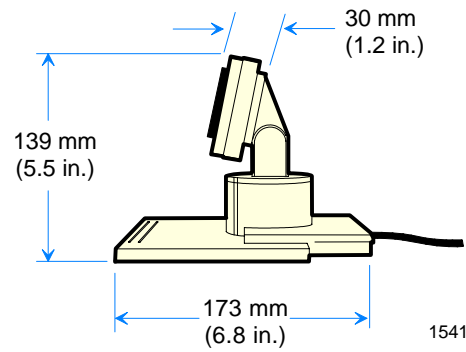
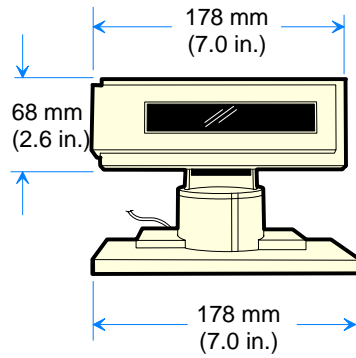
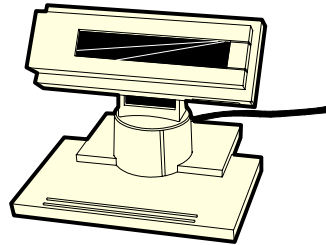

15412

Electrical Environment

VFD AC Power Requirements

- 120 VAC, 60 Hz (US, Canada, and others) via a wall mount power supply
- 90-264 VAC, 50-60 Hz via a Universal Input power supply

VFD DC Power Requirements

- 10 VDC to 14VDC (0.8 A max. at 12VDC)

LCD AC Power Requirements

- No AC P/S available. The LCD receives power from the host via a powered RS-232 connector.

LCD DC Power Requirements

- 10.6VDC to 13VDC (160mA max at 12VDC)

Operational Environment

System Configuration

The VFD communicates with the host via the parallel port or EIA-232 serial port of the host. Both interfaces are active at the same time. The display does not need to know which cable it is connected to. However, both interface cables **cannot** be connected to the unit at the same time.

The LCD communicates with the host via the serial port only.

Mounting Hole Dimensions

Mounting hole dimensions for routing cables from the Customer Display to a host terminal are explained as follows.

2x20 Customer Display Parallel Cable (VFD)

Type	P/N	Meters	Feet	Corp. ID No.
Remote	497-0405676	4.0	13.1	1416-C278-0040
Integrated	497-0405677	0.7	2.2	1416-C278-0006

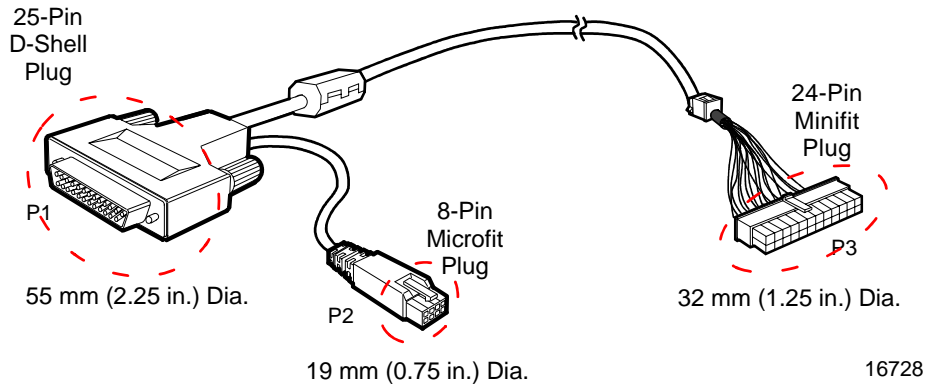

2x20 Customer Display Serial Cable (VFD)

Type	P/N	Meters	Feet	Corp. ID No.
Remote	497-0405679	4.0	13.1	1416-C279-0040
Integrated	497-0405678	0.7	2.2	1416-C279-0006

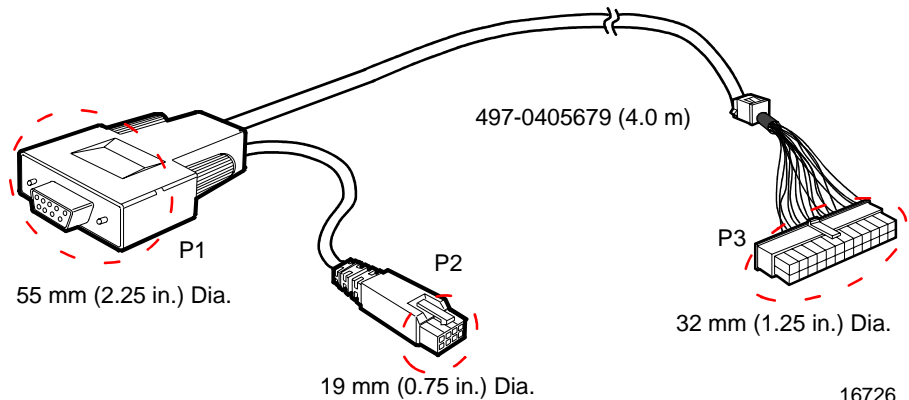

2x20 Customer Display Serial Cable (LCD)

Type	P/N	Meters	Feet	Corp. ID No.
Remote	497-0407636	4.0	13.1	1416-C278-0040
Integrated	497-0407637	0.7	2.2	1416-C278-0006

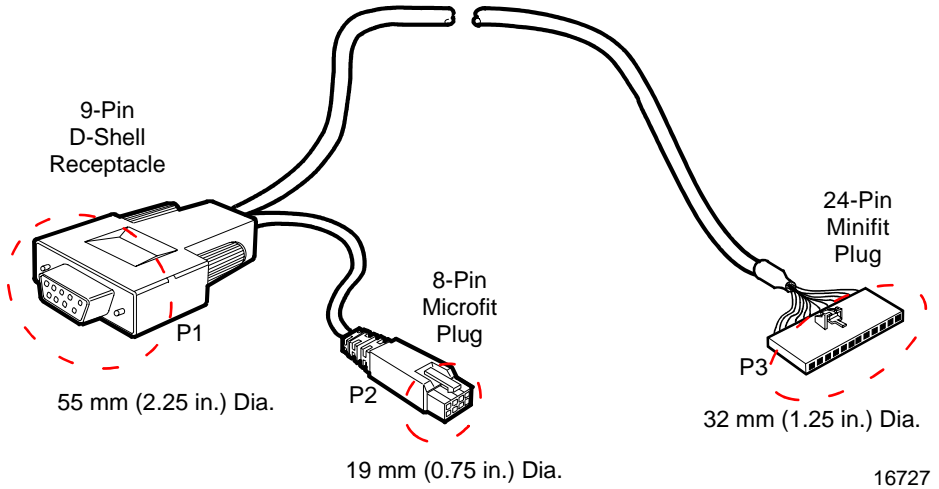

16727

Chapter 3: Installation

Installing the Customer Display

SELV Power Source Warning

This device should only be powered by a (SELV) Safety Extra Low Voltage power supply source with an available power level of 5 amperes or less, and suitable for the country of installation. The power source must be certified by the appropriate safety agency for the country of installation.

Le matériel doit être reliés électriquement au circuit à Très Basse Tension de Sécurité (TBTS) ayant une limite de 5 ampères correspondant de façon satisfaisante et acceptable dans le pays où le matériel doit être installé. Le source d'alimentation doit être approuvée par une agence de normalisation appropriée et acceptable dans le pays où le matériel doit être installé.

Warning: This device does not contain any user serviceable parts and should only be serviced by a qualified service technician.

Caution: For continued protection against risk of fire, replace only with same type and rating of fuse.

The fuse is designated F1 in the Vacuum Fluorescent Display.

Pour ne pas compromettre la protection contre les risques d'incendie, remplacer par un fusible de même type et de même caractéristiques nominales.

Caution: The power supply cord is used as the main disconnect device. Ensure that the socket outlet is located/installed near the equipment and is easily accessible.

Le cordon d'alimentation est utilisé comme interrupteur général. La prise de courant doit être située ou installée à proximité du matériel et être facile d'accès.

Installation Goal

The goal for installing the NCR 5972 Customer Display is for a reasonably trained operator or store manager to fully install the terminal in less than 15 minutes.

To qualify as *reasonably trained* an installer or store manager must be fluent with the terminology and basic technology of PC hardware and software. This level of knowledge can typically be found in an individual who has installed several PC systems, and who routinely uses a PC for personal or business computing.

Cable Requirements

Cable choices group:

- Integrated Parallel Cable (0.6 m length cable) (VFD only)
- Remote Parallel Cable (4.0 m length cable) (VFD only)
- Integrated EIA-232 Serial Cable (0.6 m length cable) (VFD only)
- Remote EIA -232 Serial Cable (4.0 m length cable) (VFD only)
- Integrated Powered EIA-232 Cable (1.0m length cable) (VFD only)
- Remote Powered EIA-232 Serial Cable (4.0m length cable) (VFD only)
- Integrated Powered EIA-232

Power Supply Choices

Power Supply Choices Group:

- No Power Supply for 7452/7453 applications
- Universal Input Power Supply Adapter; 90-264 VAC, 50-60 Hz; (VFD only)

Installation Procedures

Not all models are supported for every NCR retail terminal. For specific installation instructions see the appropriate retail terminal Hardware User's Guide.

NCR 5952/5962 Integrated Mount

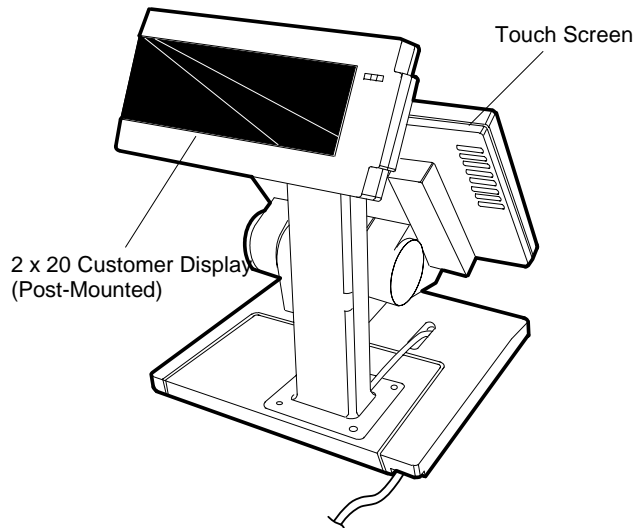

12682

See the *NCR 5952 Wedge DynaKey User's Guide (BD20-1370-A)*, or *NCR 5962 Wedge Touch Screen User's Guide (BD20-1371-B)* for procedures how to install the integrated mount.

RS-232 Serial Interface

You can connect the Customer Display to one of the host terminal 9-pin serial connector. Configure the terminal serial port as follows:

- 9600 baud
- 8 data bits
- 1 start bit
- No parity
- 1 stop bit
- Half-Duplex

Diagnostics

The 5972 Customer Display has internal Power Up Diagnostics that occur soon after power-up or if a Reset Display command is received from the host software.

When the hardware is powered down, all registers and memory are lost. No recovery is possible.

The Power Up Diagnostics include the following tests:

- Micro-controller test
- External character PROM test (VFD only)
- Pixel Number Display

Micro-controller Test

For serial communications, the CTS line is set in a Marking condition (negative voltage) at the start of the test. For VFD parallel communications, the Busy line is set active at the start of the test. The first test is the Micro-controller test which checks operation at the Micro-controller.

If an error is discovered, testing halts, and the firmware begins executing a *forever do nothing* loop. No response is sent to the host. If the Micro-controller Test passes, the CTS and Busy line exception conditions are lifted.

External Memory Test Character (VFD Only)

A separate test is performed on the external character PROM, if it exists. The PROM status is noted and saved for terminal retrieval later using the Reset command.

If an error is discovered, all character sets stored in the PROM are considered invalid, and any command received attempting to switch to one of these character sets is treated as an invalid command and ignored.

Pixel Test

All Pixels are turned on for two seconds. The unit does not have the capability to determine if it passes this pixel test. You must visually examine the display for any pixel failure.

Firmware Part Number Display

The current firmware part number of the unit is displayed for two seconds.

Chapter 4: Programming Set Up

Firmware and software function descriptions for the NCR 5972 Retail Display are presented in this chapter.

Host/Retail Display Command Interface

The Retail Display accepts two types of data: display data and command data. If a byte received from the host is any character except the ESC (0x1B) character, it is processed as a character and displayed on the Retail Display. If an ESC character (0x1B) is received, the subsequent byte(s) is processed as a command. If the subsequent byte is an invalid command it is ignored. If an ESC is received, but no command byte is received immediately, the firmware waits forever if need be and uses the next received byte(s) to complete the command.

Note: Each command consists of at least two bytes. The first byte (0x1B) is a command identifier indicating the next byte(s) is a command byte. The command byte may be followed by parameter or data bytes depending on the command. Also note that the ESC character can be displayed by using the Display ESC Character command.

Retail Display Commands

The following table describes the Retail Display commands supported:

Command	Function
1B 01	Reset Display
1B 02	Erase Display
1B 04	Set Diagnostic State On
1B 05	Set Display State On
1B 06	Set Low Power State On (Default)
1B 07	Enable Cursor
1B 08	Disable Cursor (Default)
1B 09	Set Screen Save Blank
1B 0A	Set Screen Save Walk (Default)
1B 0B	Turn On Screen Save
1B 0C	Disable Screen Save Feature
1B 0D	Enable Character Blink
1B 0E	Disable Character Blink (Default)
1B 0F	Move Cursor Left
1B 10	Move Cursor Right
1B 11	Move Cursor Up
1B 12	Move Cursor Down
1B 13	Set Cursor Position
1B 17	Brightness Adjustment (Default - 5) ¹
1B 18	Read Display ID
1B 19	Read Display Part Number

¹ This command is not supported by the LCD. The only action taken is to take the display out of Screen Save.

Command	Function
1B 1B	Display ESC Character
1B 20	Select Character Set 1 (Default) ¹
1B 21	Select Character Set 2 ¹
1B 22	Select Character Set 3 ¹
1B 23	Select Character Set 4 (External ROM required) ¹
1B 24	Select Character Set 5 (External ROM required) ¹
1B 25	Select Character Set 6 (External ROM required) ¹
1B 26	Select Character Set 7 (External ROM required) ¹
1B 27	Select Character Set 8 (External ROM required) ¹
1B 28	Select Character Set 9 (External ROM required) ¹
1B 29	Select Character Set 10 (External ROM required) ¹
1B 2A	Select Character Set 11 (External ROM required) ¹
1B 2B	Select Character Set 12 (External ROM required) ¹
1B 2C	Select Character Set 13 (External ROM required) ¹
1B 2D	Select Character Set 14 (External ROM required) ¹
1B 2E	Select Character Set 15 (External ROM required) ¹
1B 2F	Select Character Set 16 (External ROM required) ¹
1B 30	Select Character Set 17 (External ROM required) ¹
1B 31	Select Character Set 18 (External ROM required) ¹
1B 32	Select Character Set 19 (External ROM required) ¹

Reset Display

Format: 1B 01

Returns: xx yy zz

- where xx is the Microcontroller status:
 - 00 = OK

If a failure occurs, testing halts, and the firmware begins executing a loop as described in the *Internal Power UP Diagnostics* section in the *Installation* chapter.
- where yy is the External Character PROM status:
 - 00 = Not present (Always 00 for LCD)
 - 01 = OK, present
 - FF = Failure
- where zz is the number (in hex) of character sets available in the External Character PROM
 - 00 = 10 (Always 00 for LCD)

Description: This command executes the power-down power-up diagnostic sequence. The communication lines (CTS for serial, BUSY for parallel) are placed in an exception condition (see the *Internal Power UP Diagnostics* section in the *Installation* chapter). The Microcontroller test consists of a check-sum test on the ROM and a write/read test on the RAM. A check-sum test is also performed on the External Character PROM that holds any user-defined characters sets (This does not apply to the LCD).

After executing the command, the three status bytes (see above) are sent to the host, the display screen is cleared, the cursor moves to the 0 position, communication line exception conditions are cleared, and all registers and variables are initialized. Note that the screen is cleared during this command. If a host needs previous data redisplayed, the host must resend the previous data after this command has completed.

Erase Display

Format: 1B 02

Description: This command clears all of the displayed characters by writing a space to each display position. A space is defined as character 0x20 of the current character set. The cursor moves to the 0 position.

Set Diagnostic State On

Format: 1B 04

Description: This state is exclusive from the On and Low Power States. This command causes the firmware to display the current firmware part number of the device for five seconds, and then step through each installed 256-character set (default and user-defined) displaying one character at a time on all 40 display positions at a rate of about one character per second. The firmware starts with the currently selected character set, and then displays all of the characters from the other sets the same way. This continues until one of the other state commands is performed. Prior display data is saved and can be restored before sending the Set Display State On.

Note: The LCD only has one character set.

Set Display State On

Format: 1B 05

Description: This state is used for normal run-time conditions. This operation instructs the firmware to leave one of the other states and begin performing normal refresh operations. There may be a slight delay before the Vacuum Fluorescent Display (VFD) reaches the specified brightness setting when exiting the Low Power State. This delay should not exceed 1 second from the time the command is received until the time the VFD reaches the specified brightness.

The Screen Save feature may be in force during the Display On state. This means that after about five minutes of no new display activity, the Screen Save feature could take over and cause the display to go blank or begin walking from right to left.

Set Low Power State On

Format: 1B 06

Description: This state is used to reduce Retail Display power consumption and extend the life of the Retail Display VFD. Power is removed from the display, but the Retail Display controller is still fully operational and continues to accept commands. This command causes the firmware to blank or turn off the Retail Display. Display data can be processed while the display is in the Low Power State, but it does not appear until the Low Power State is changed. The displayed characters are preserved so that upon leaving the Low Power State, the display is restored. To leave the Low Power State, one of the other state commands must be received. This is the default state for the Retail Display after power-up.

Enable Cursor

Format: 1B 07

Description: This command causes a flashing cursor to be used whenever the Display On state is in force. When the cursor is enabled, the cursor is visible and flashing at the current cursor position. The flashing cursor should be visible for 1 second and then the character at the cursor position should be visible for 1 second. The effect is to alternate between the character and the cursor. The cursor is defined as character 0X5F of whatever character set is currently chosen. For the three supported character sets, the cursor is the bottom row of pixels turned on. For a user-defined character set, the cursor is whatever is defined as character 0X5F of the character set. When the cursor is enabled, it overwrites the character at the cursor position. If the cursor is disabled, the character at the cursor position is left visible.

Note: The cursor on the LCD blinks on and off every .5 second. The cursor displays concurrently with whatever character may already be displayed at the cursor position.

Disable Cursor

Format: 1B 08

Description: This command causes the cursor to be turned off. This is the default state for the cursor after power-up.

Set Screen Save Blank

Format: 1B 09

Description: This command is intended to preserve the life of the display hardware unit. The firmware maintains a five-minute timer that triggers this feature. The Screen Save feature can be disabled through a command from the host software. When the feature is not disabled, two specific options exist. The Set Screen Save Blank operation causes the display to go blank when the timer expires. When the firmware receives the command code, the Screen Save mode is canceled, and the five-minute timer is established. Screen Save Blank removes power from the Retail Display, and refreshes the display in the same manner as the Set Low Power On command. At power up, the timer is established at five minutes, and Screen Save Blank is established as a default. The five minute timer is not reset by any invalid or incorrect command.

Set Screen Save Walk

Format: 1B 0A

Description: This command causes the visible display to walk right to left when the Screen Save timer expires (five minutes). The characters on the display appear to walk across the corresponding display row from right to left. The two lines in the 2x20 Display walk in parallel completely off the left side of the display, and then the two lines appear to come back from the right. If the display is space filled, then no effect is perceived even though the walking is taking place. The Screen Save Blank mode is the default mode after power up.

Turn On Screen Save

Format: 1B 0B

Description: This command causes one of the screen save functions (Set Screen Save Blank or Set Screen Save Walk) to activate immediately rather than waiting for the screen save timer to expire. If the Disable Screen Save command is in effect when this command is issued, it is canceled, and the screen saver is enabled and activated immediately.

Disable Screen Save Option

Format: 1B 0C

Description: The firmware ceases to keep time for the screen save activity from the host software, and the display neither goes blank nor begins to walk due to inactivity from the host. This command can be canceled by the Turn On Screen Save, Set Screen Save Blank, and Set Screen Save Walk commands.

Enable Character Blink

Format: 1B 0D

Description: The blink attribute is the only modifier which is supported for the display character positions. Each time a new character is received, the current setting of the character blink operator is adopted as the working attribute for the new character. If a new character is received while character blink is enabled, the new character blinks. This makes it possible to have a display with both blinking and non-blinking characters. For the VFD, the blink period is 1 second on and 1 second off. For the LCD, the blink period is .5 second on and .5 second off. All characters that are blink enabled blink at the same time. The only way to cause an existing character to start or stop blinking is to set up the character blink operator, move the cursor to the correct character, and resend the individual character code.

Disable Character Blink

Format: 1B 0E

Description: This command counteracts the Enable Character Blink. The firmware implements all new character codes with an on and holding character presentation. On power up, the character blink modifier is defaulted to disabled.

Move Cursor Left

Format: 1B 0F

Description: Moves the cursor one position to the left. When the cursor is at the left end of the upper line, it moves to the right end of the lower line. When the cursor is at the left end of the lower line, it moves to the right end of the upper line. The cursor location always indicates the position of the next character to be displayed, whether the cursor is enabled and blinking or not. After each character is displayed, the firmware performs a logical Move Cursor Right command.

Move Cursor Right

Format: 1B 10

Description: Moves the cursor one position to the right. When the cursor is at the right end of the upper line, it moves to the left end of the lower line. When the cursor is at the right end of the lower line, it moves to the left end of the upper line. The cursor location always indicates the position of the next character to be displayed, whether the cursor is enabled and blinking or not. After each character is displayed, the firmware performs a logical Move Cursor Right command. When the cursor is at the right end of the lower line, it moves to the left end of the upper line and operates in an Overwrite Mode. The next character sent to the display overwrites the character in the left end of the upper line.

Move Cursor Up

Format: 1B 11

Description: Moves the cursor up one line. When the cursor is on the upper line, the cursor is moved to the same column on the lower line. The cursor location always indicates the position of the next character to be displayed, whether the cursor is enabled and blinking or not. After each character is displayed, the firmware performs a logical Move Cursor Right command.

Move Cursor Down

Format: 1B 12

Description: Moves the cursor down one line. When the cursor is on the lower line, the cursor is moved to the same column on the upper line. The cursor location always indicates the position of the next character to be displayed, whether the cursor is enabled and blinking or not. After each character is displayed, the firmware performs a logical Move Cursor Right command.

Move Cursor To Specified Position

Format: 1B 13 *nn*

Range: $00 \leq nn \leq 27$ (hex)

Description: Moves the cursor to the specified position. Position 0 is the upper leftmost position, and position 27 is the lower rightmost position. Any value outside this range is discarded, the command is ignored, and the cursor is moved. The cursor location always indicates the position of the next character to be displayed, whether the cursor is enabled and blinking or not. After each character is displayed, the firmware performs a logical Move Cursor Right command. The character positions are shown in the following:

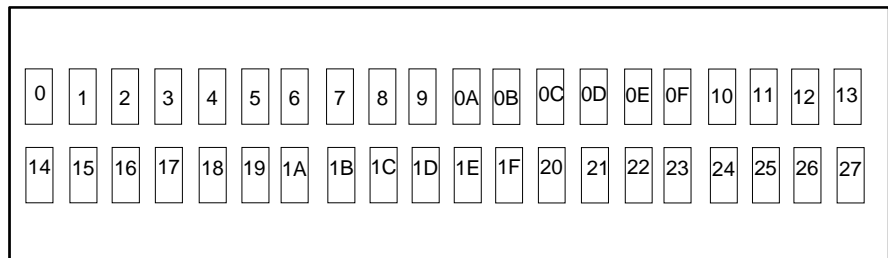

 = Character Display Position

14526

Character Display Positions

Brightness Adjustment

Format: 1B 17 *nn*

Range: $01 \leq nn \leq 05$

Description: Adjusts the brightness of the entire display. Individual characters or display positions are not adjusted. On power up, the default brightness setting is 5 (100%).

<i>Nn</i>	Brightness
01	20%
02	40%
03	60%
04	80%
05	100%

Note: This command is not supported by the LCD. The only action taken is to take the display out of Screen Save.

Read Display ID Byte

Format: 1B 18

Returns: 0x8A

Description: This command is a request for the Retail Display to return an identifier. The Retail Display returns one byte (0x8A) that identifies the Retail Display as a 2x20 with 7x9 dot matrix.

Read Display ID String

Format: 1B 19

Returns: 0x1A, "NCR 5972, XXX-XXXXXXX"

Description: where 0x1A is a 1 byte string length indicator which indicates the length of the string that follows the string length indicator. For example, 1AH characters are sent after the string length indicator. Note: indicates a space character (20H). The quotation marks "" are not part of the string and are not returned. XXX-XXXXXXX represents the current firmware part number.

Description: This command is a request for the Retail Display to return an ASCII string with detailed product information.

Display ESC Character

Format: 1B 1B

Description: This command is a request for the ESC character to be displayed at the current cursor position.

Select Character Set *n*

Format: 1B20 - 1B32

Description: VFD only. This set of commands chooses one of the three supported internal character sets or, if an external ROM is present, one of up to 16 additional character sets. Character set 1 is defined as PC Code Page 858 (International), character set 2 is defined as Katakana (Japanese), and character set 3 is defined as Code Page 866 (Cyrillic Eastern European). Character sets 4 through 19 are only valid if an external ROM containing extra character sets is present. Character set selection is dynamic. Host software can switch between character sets at any time. Switching between sets does not erase or change the display. This means characters from multiple character sets may be on a display. The default character set is number 1, PC Code Page 858 (International).

Character Sets

There are three character sets pre-installed.

- Code 858 (International) (VFD and LCD)
- Katakana (VFD only)
- Code 866 (Cyrillic) (VFD only)

The VFD supports 16 additional character sets of 256 characters each. These additional character sets are inside a PROM that plugs into a socket on the PCB. All of the characters sets are stored in non-volatile memory.

Code Page 850 (International)

000	001	002	003	004	005	006
.....●●●.●
.....	..●●●●.	..●●●●.●●●.●●●
.....	●.....●	●●●●●●	..●●.●●●	..●●●.●●●●
.....	●.●.●.●	●●.●.●●	●●●●●●	..●●●.	●●.●.●●	●●●●●●
.....	●.....●	●●●●●●	●●●●●●	..●●●.	●●●●●●	●●●●●●
.....	●.●●●.●	●●.●.●●	..●●●●.	..●●●.	●●.●.●●	..●●●●.
.....	●.●.●.●	●●●●.●●	..●●●.●●●
.....	..●●●●.	..●●●●.●●●●●●.
.....
007	008	009	010	011	012	013
.....	●●●●●●	●●●●●●
.....	●●●●●●	●●●●●●●●●●●
.....	●●●●●●●●●	●.....●●●.●●●●●●●
.....	●●●●.●●●.●	●.●●●.●●.●●.●●
.....	●.....●●.●	●.●●●.●●.●
.....	●●●●.●●●.●	●.●●●.●●●●●●●●.●
.....	●●●●.●●●.●	●.●●●.●●●.●
.....	●●●●●●●●●	●.....●●●.●●●●●●●●
.....	●●●●●●	●●●●●●●●●●●●●
.....	●●●●●●	●●●●●●

014

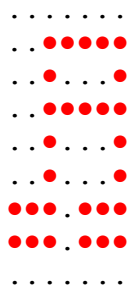

015

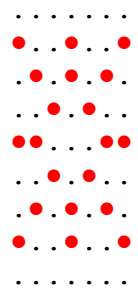

016

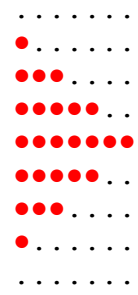

017

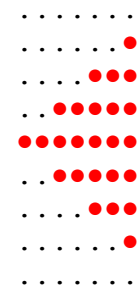

018

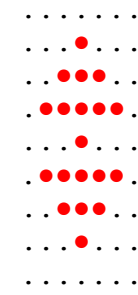

019



020

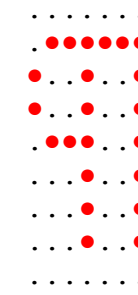

021

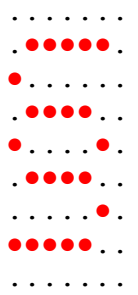

022

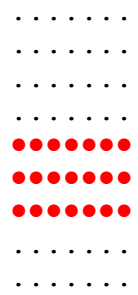

023

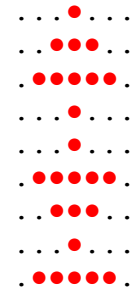

024

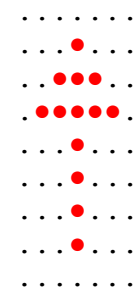

025

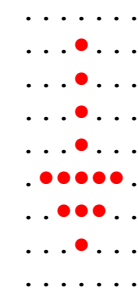

026



027

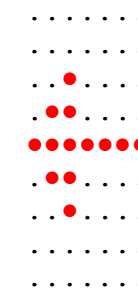

028

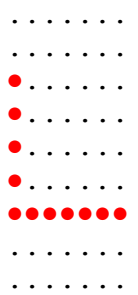

029

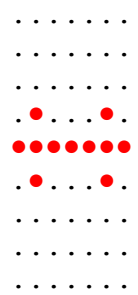

030

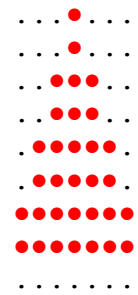

031

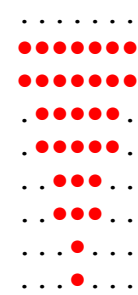

032

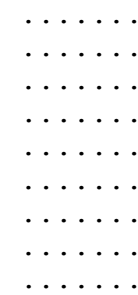

033

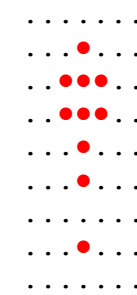

034

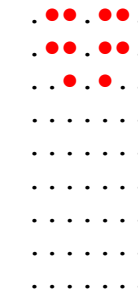

035

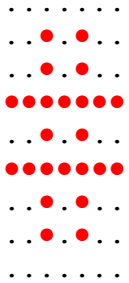

036

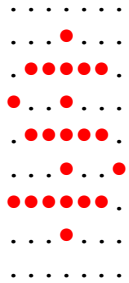

037

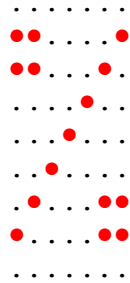

038

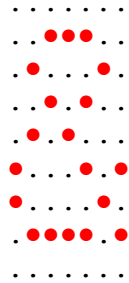

039

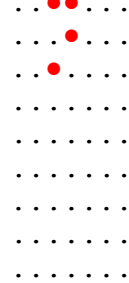

040

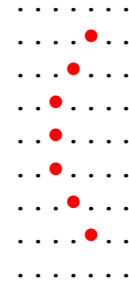

041

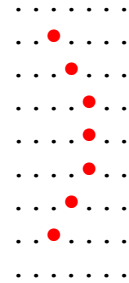

042

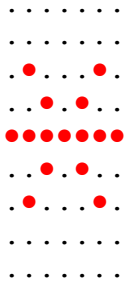

043

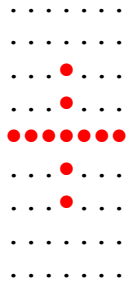

044

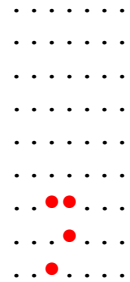

045



046

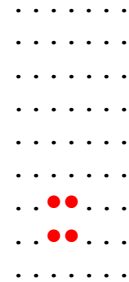

047

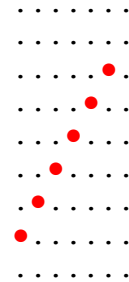

048

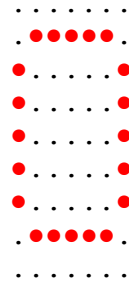

049

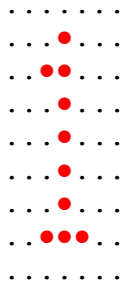

050

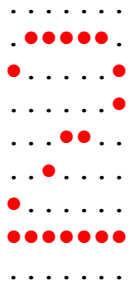

051

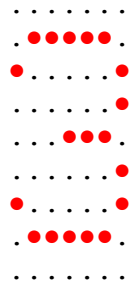

052

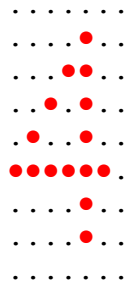

053



054



055

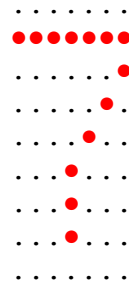

056

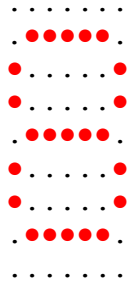

057

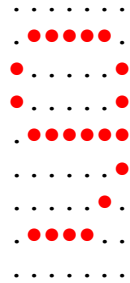

058

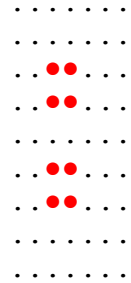

059

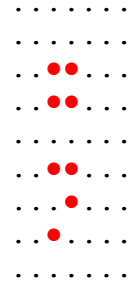

060

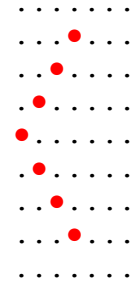

061



062

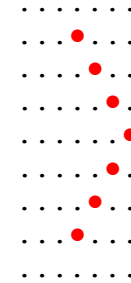

063

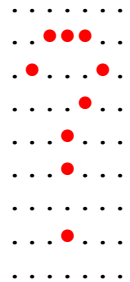

064

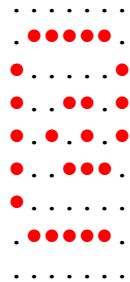

065

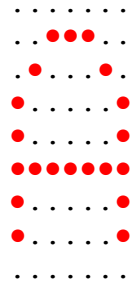

066

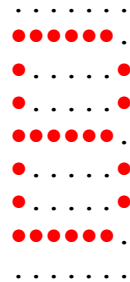

067

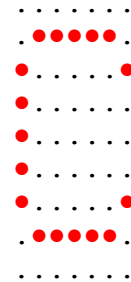

068

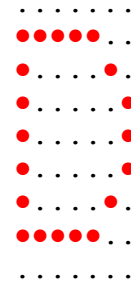

069



070

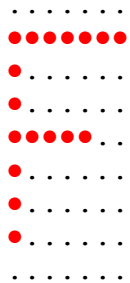

071

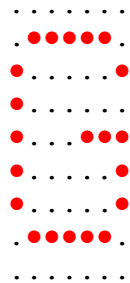

072

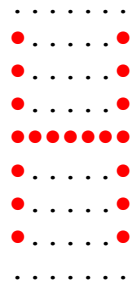

073

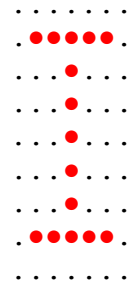

074

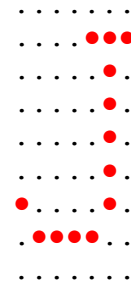

075

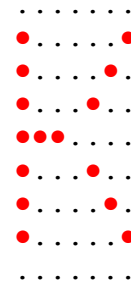

076

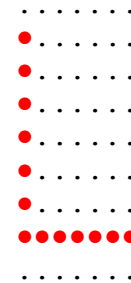

077

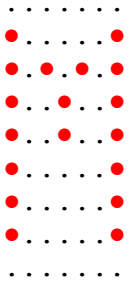

078

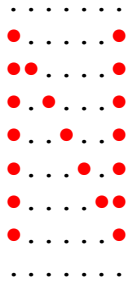

079

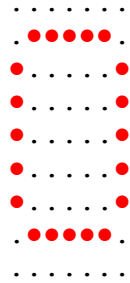

080

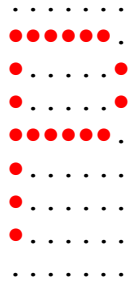

081

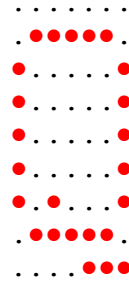

082

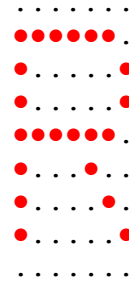

083

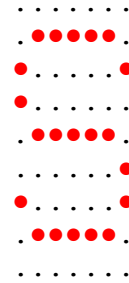

084

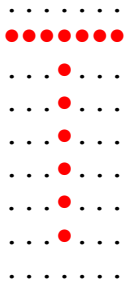

085

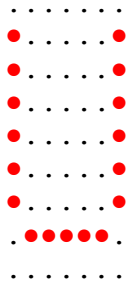

086

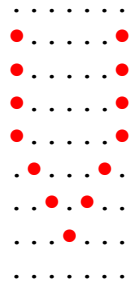

087

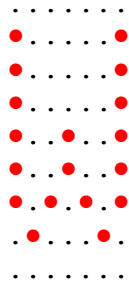

088

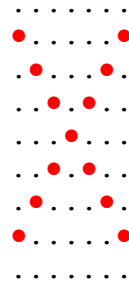

089

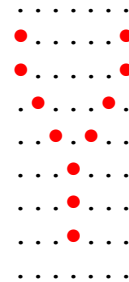

090

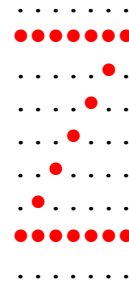

091

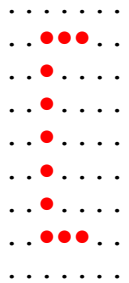

092

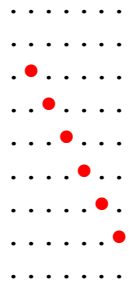

093

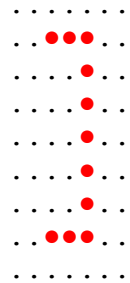

094

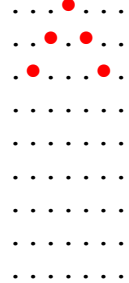

095

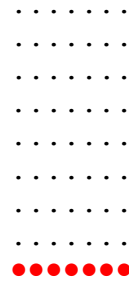

096

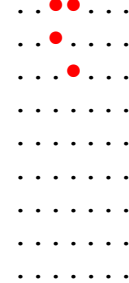

097

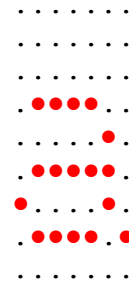

119

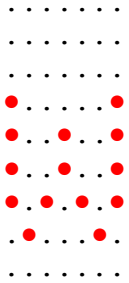

120

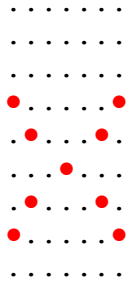

121

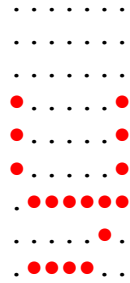

122



123

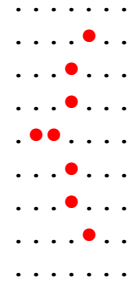

124

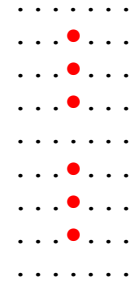

125

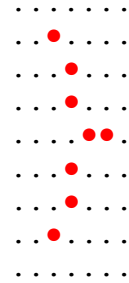

126

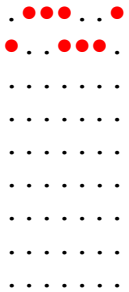

127

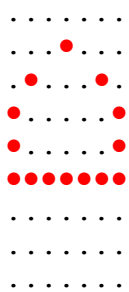

128

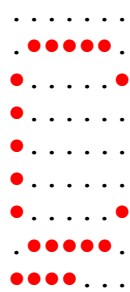

129

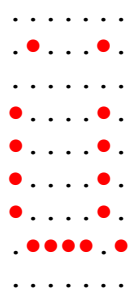

130



131

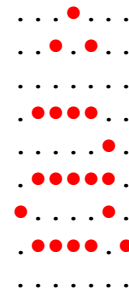

132

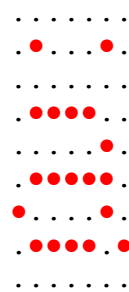

133

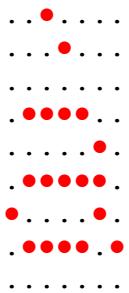

134

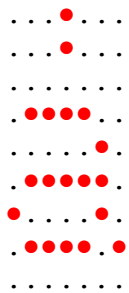

135

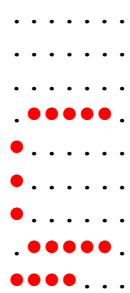

136

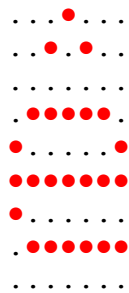

137



138



139

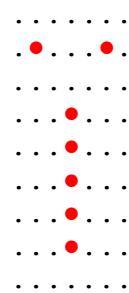

161

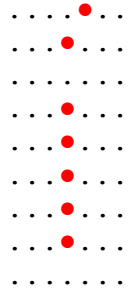

162

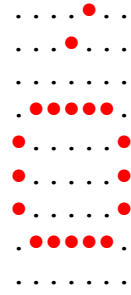

163

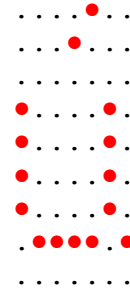

164



165

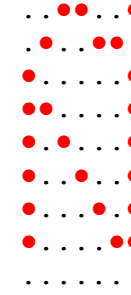

166

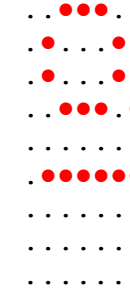

167

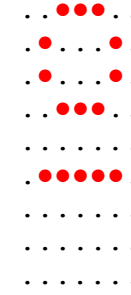

168

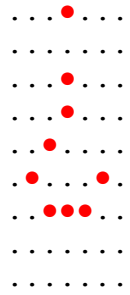

169

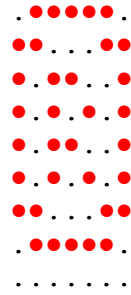

170

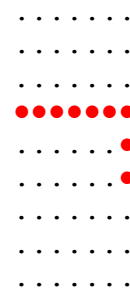

171

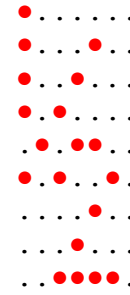

172

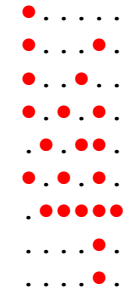

173

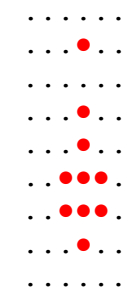

174

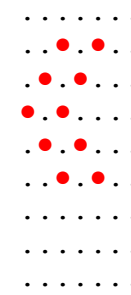

175

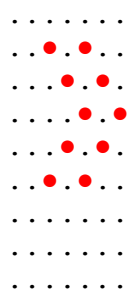

176

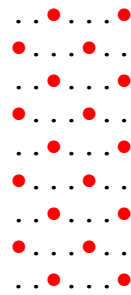

177

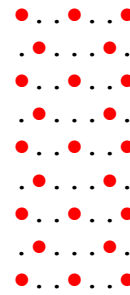

178

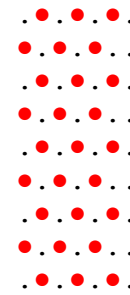

179

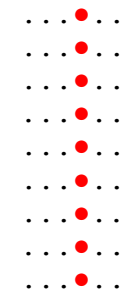

180

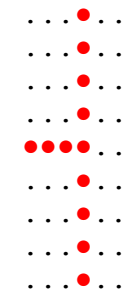

181



182

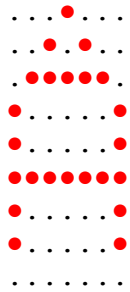

183

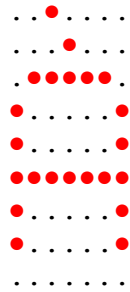

184

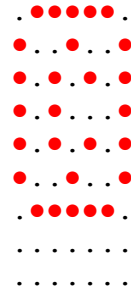

185

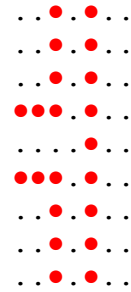

186

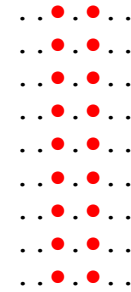

187



188

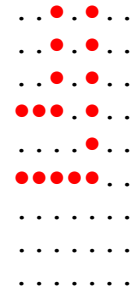

189

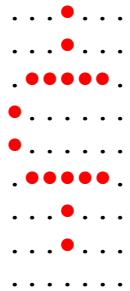

190

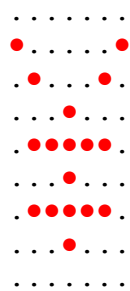

191

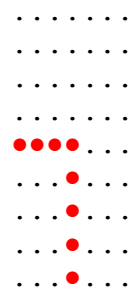

192

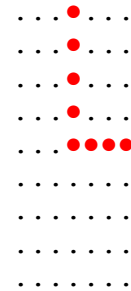

193

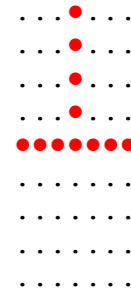

194



195

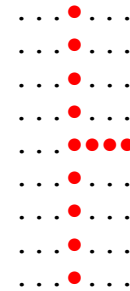

196

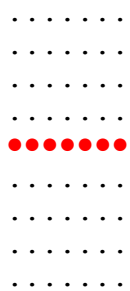

197

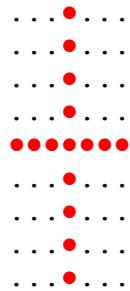

198

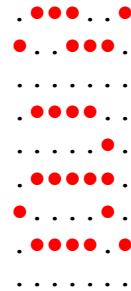

199



200



201

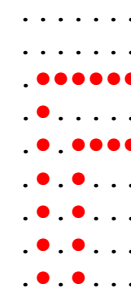

202



224

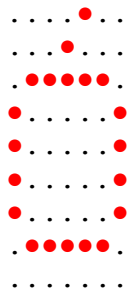

225

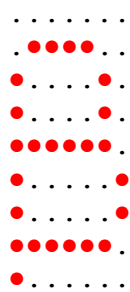

226

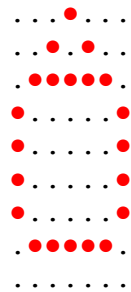

227

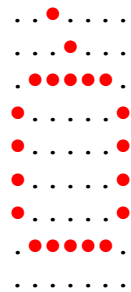

228

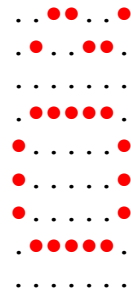

229

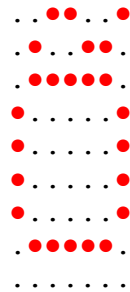

230

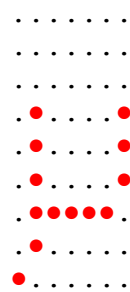

231

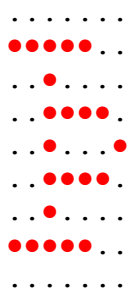

232

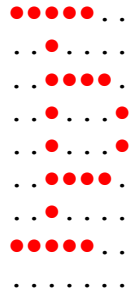

233

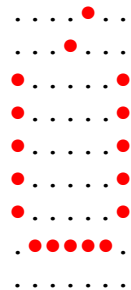

234

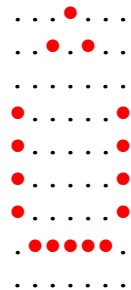

235

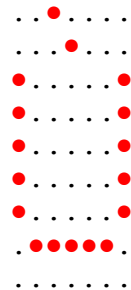

236

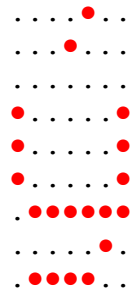

237

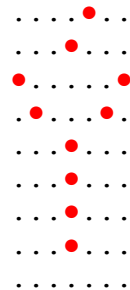

238

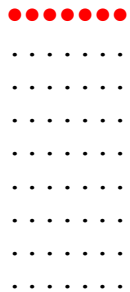

239

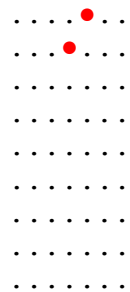

240

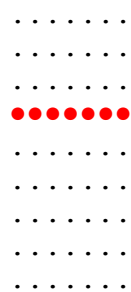

241

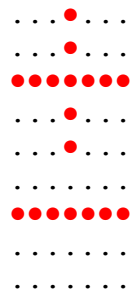

242

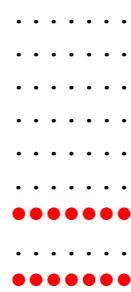

243

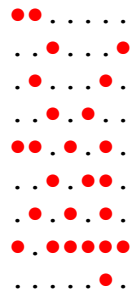

244

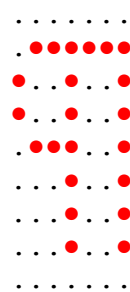

021

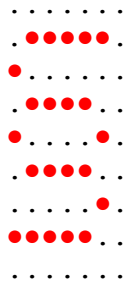

022



023

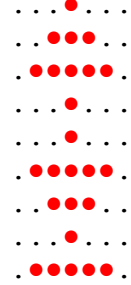

024



025

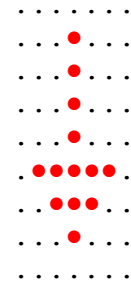

026



027



028

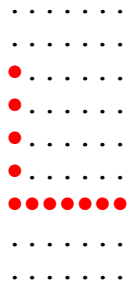

029

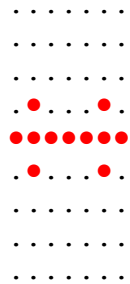

030

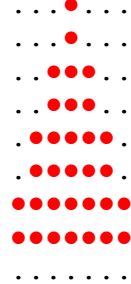

031

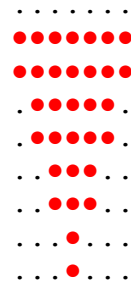

032

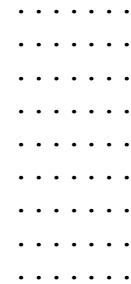

033

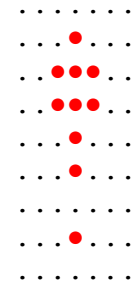

034

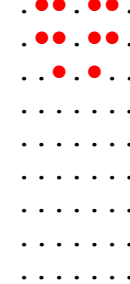

035

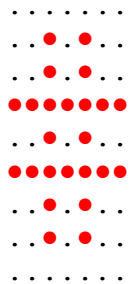

036

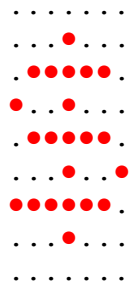

037

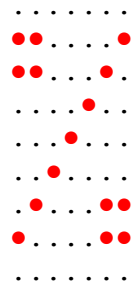

038

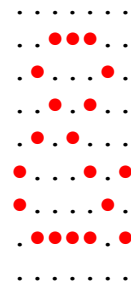

039

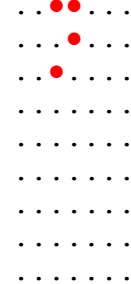

040

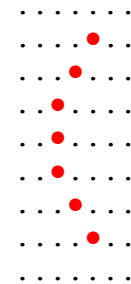

041

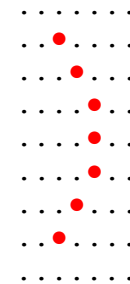

042

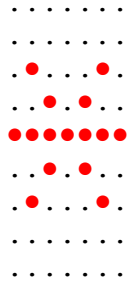

043

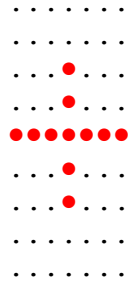

044

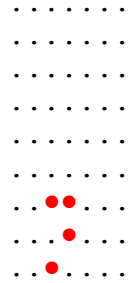

045

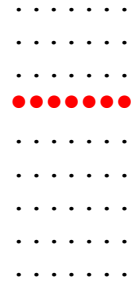

046

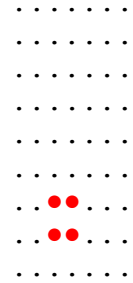

047

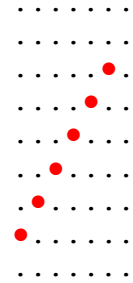

048

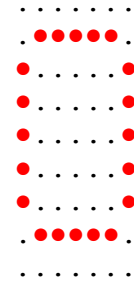

049

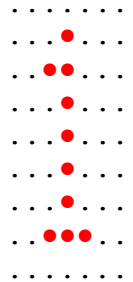

050

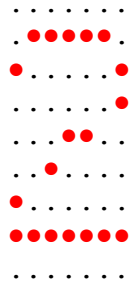

051

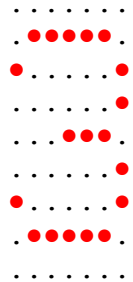

052

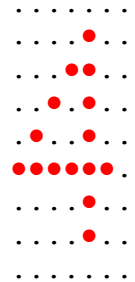

053

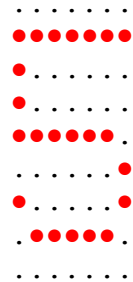

054

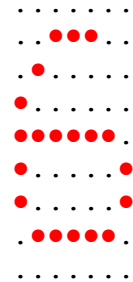

055

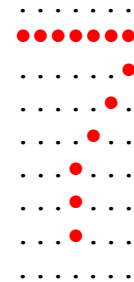

056

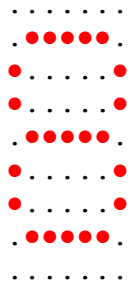

057

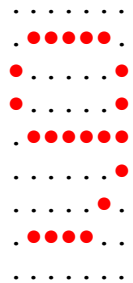

058

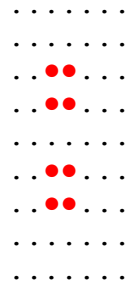

059

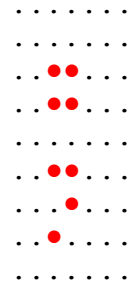

060

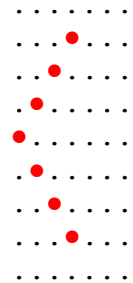

061

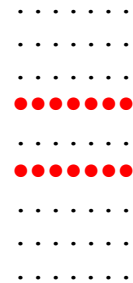

062

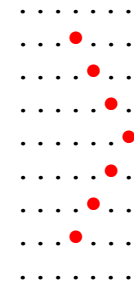

063

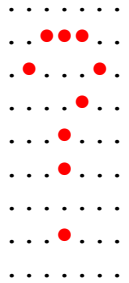

064

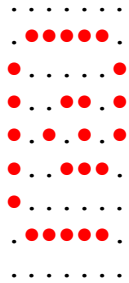

065

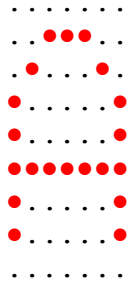

066

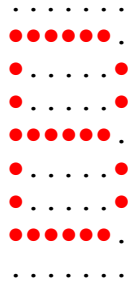

067

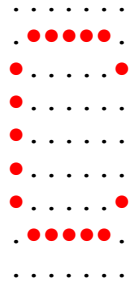

068

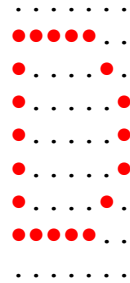

069

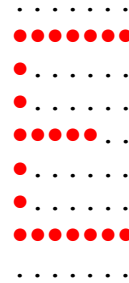

070

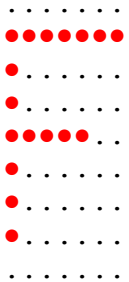

071

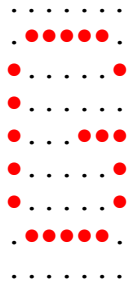

072

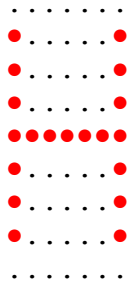

073

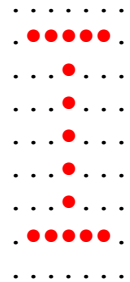

074

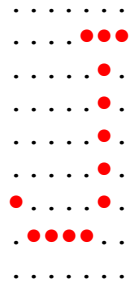

075

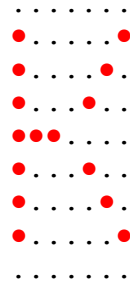

076

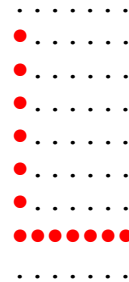

077

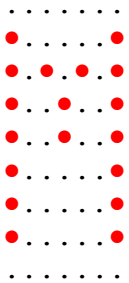

078

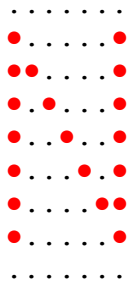

079

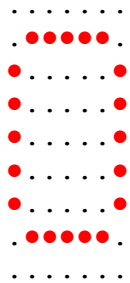

080

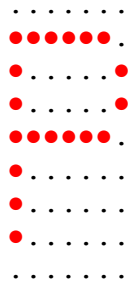

081

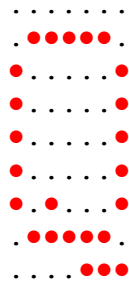

082

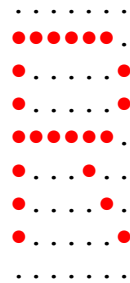

083



084

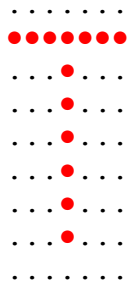

085

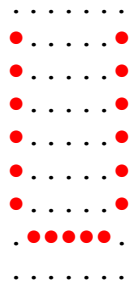

086

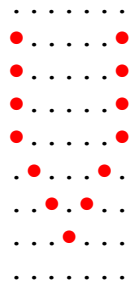

087

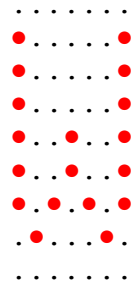

088

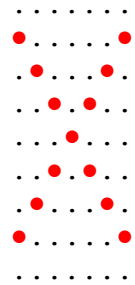

089

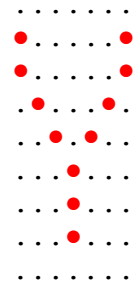

090

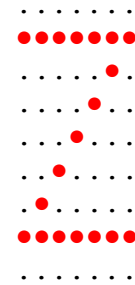

091

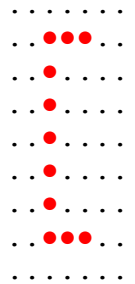

092

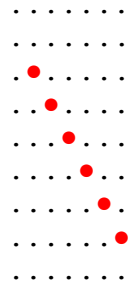

093

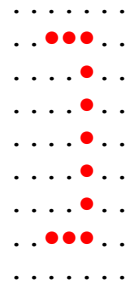

094

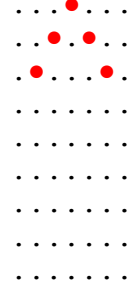

095

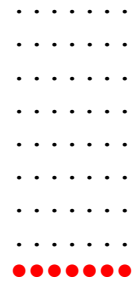

096

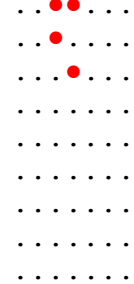

097

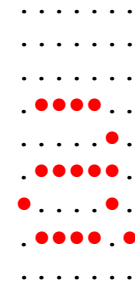

098

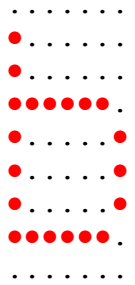

099

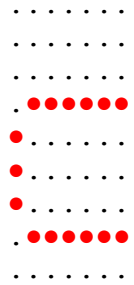

100

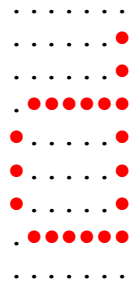

101

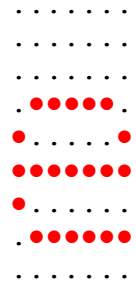

102

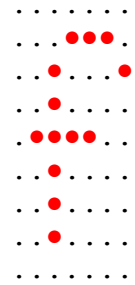

103

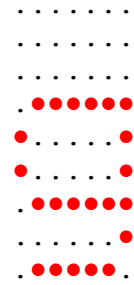

104

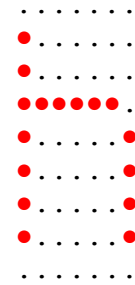

105

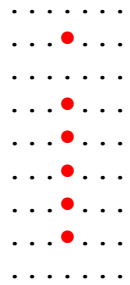

106

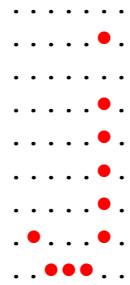

107

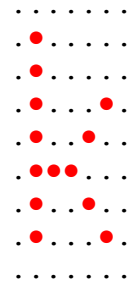

108

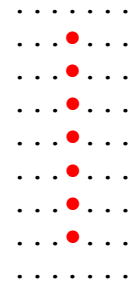

109

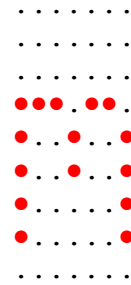

110

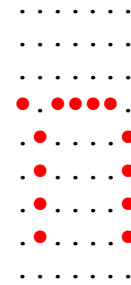

111

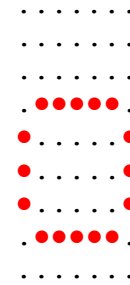

112

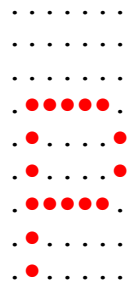

113

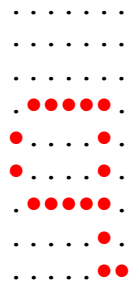

114

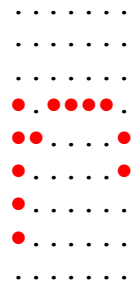

115

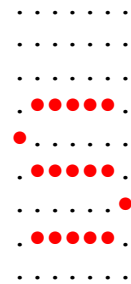

116

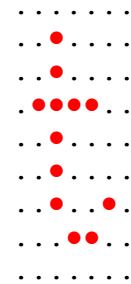

117

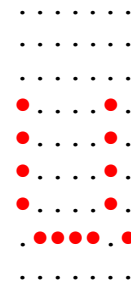

118

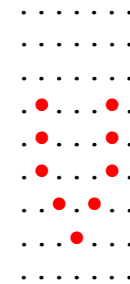

119

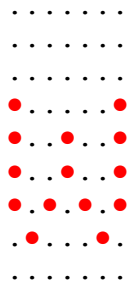

120

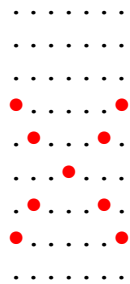

121

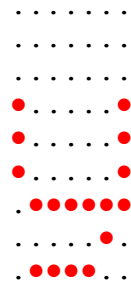

122



123

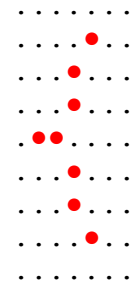

124

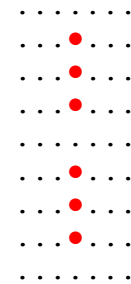

125

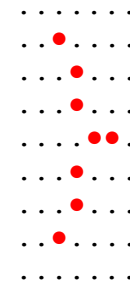

126

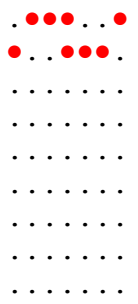

127

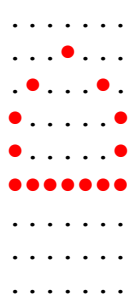

128

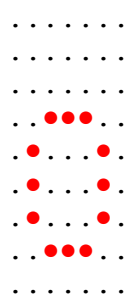

129

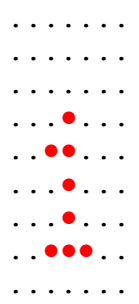

130

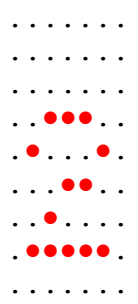

131

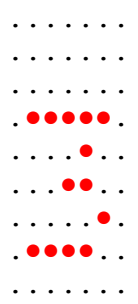

132

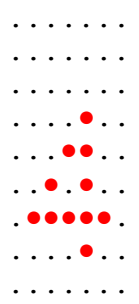

133

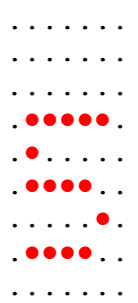

134

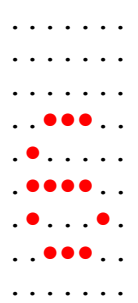

135

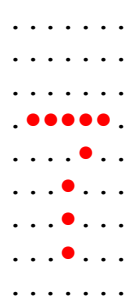

136

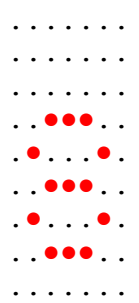

137

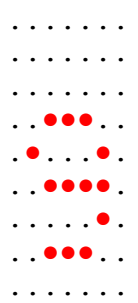

138

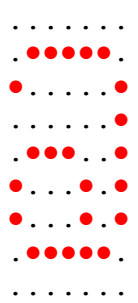

139

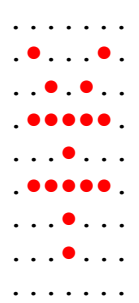

140

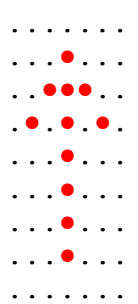

141

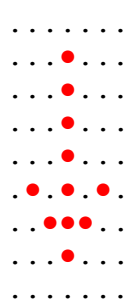

142

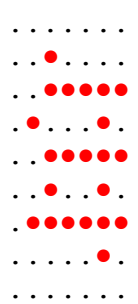

143

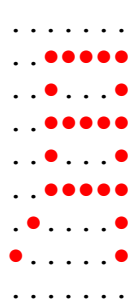

144

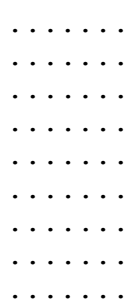

145

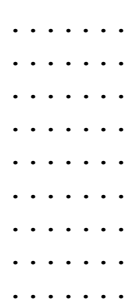

146

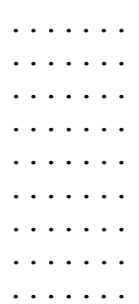

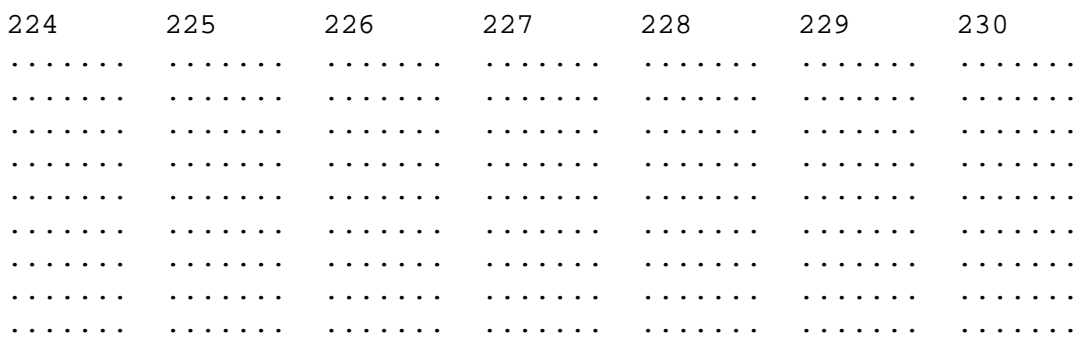
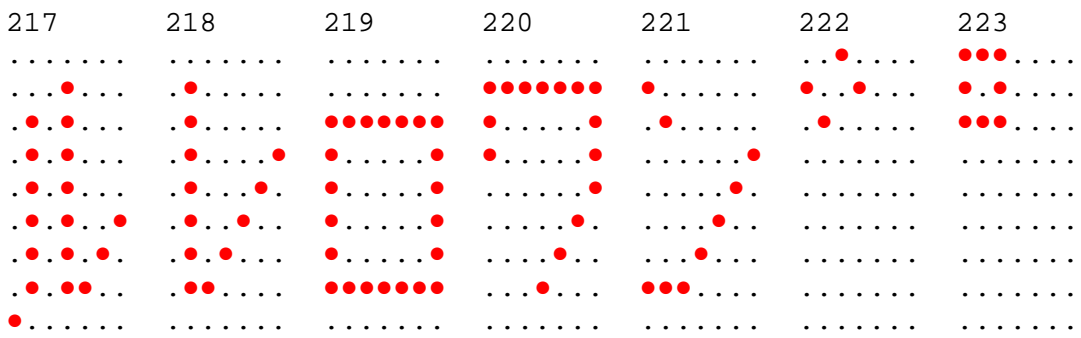
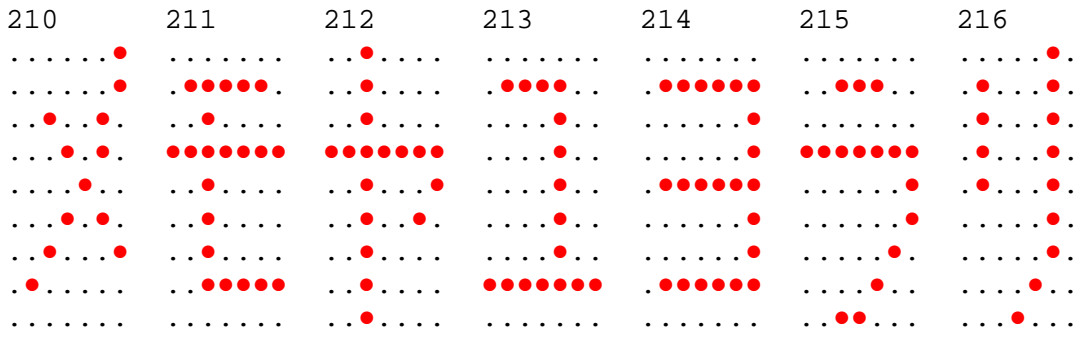

021

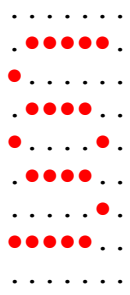

022



023

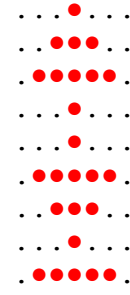

024



025

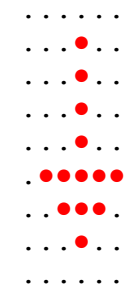

026

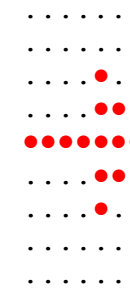

027

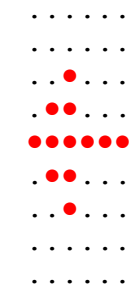

028

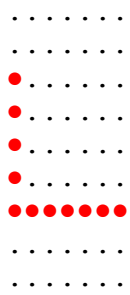

029

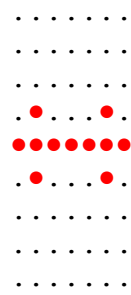

030

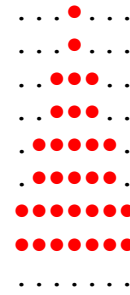

031

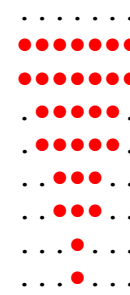

032

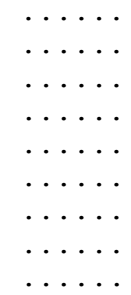

033

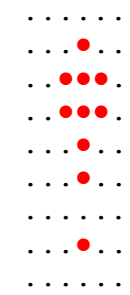

034

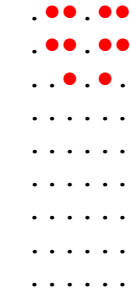

035

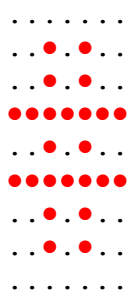

036

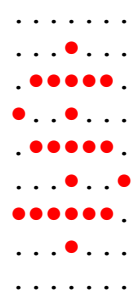

037

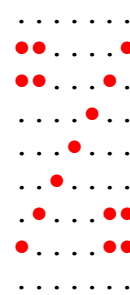

038

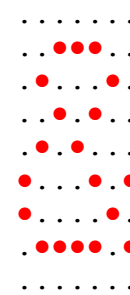

039

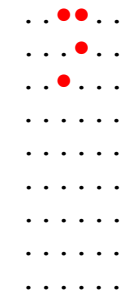

040

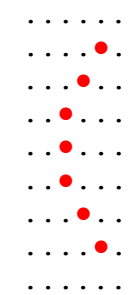

041

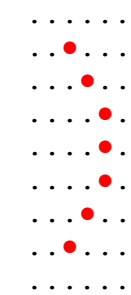

042

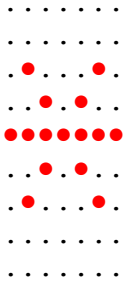

043

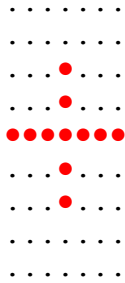

044

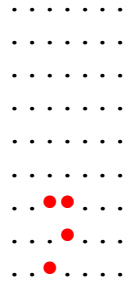

045

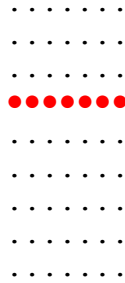

046

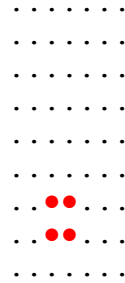

047

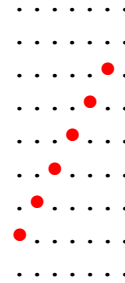

048

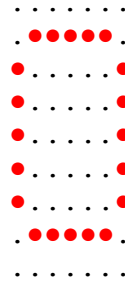

049

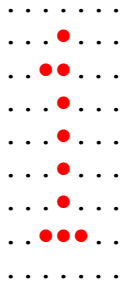

050

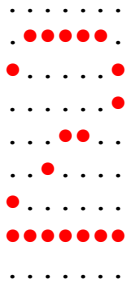

051

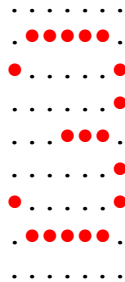

052

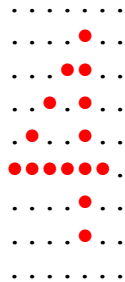

053

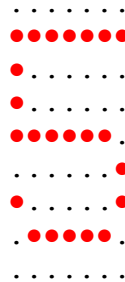

054



055

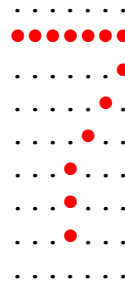

056

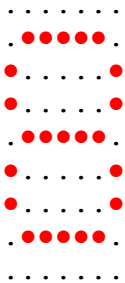

057

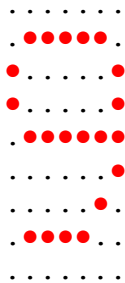

058

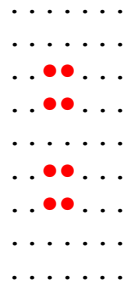

059

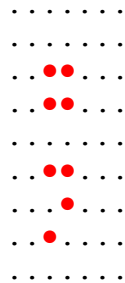

060

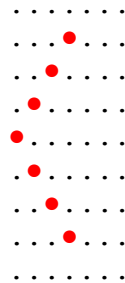

061

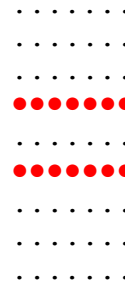

062

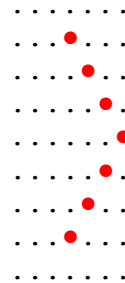

063

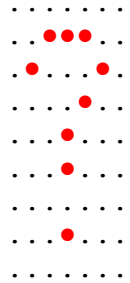

064

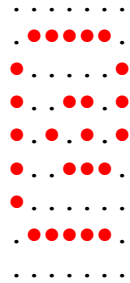

065

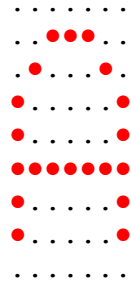

066

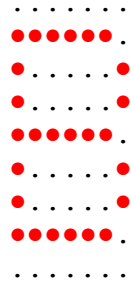

067

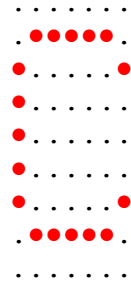

068

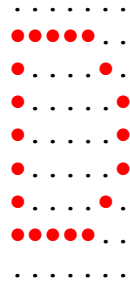

069

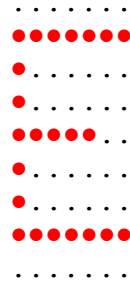

070

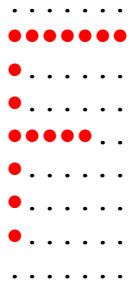

071

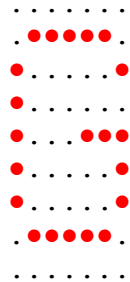

072

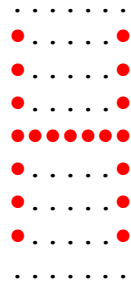

073

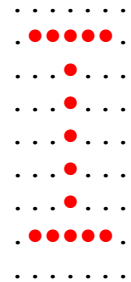

074

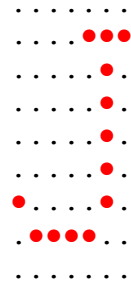

075

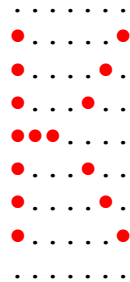

076

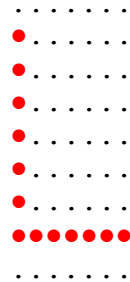

077

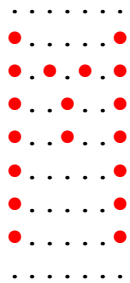

078

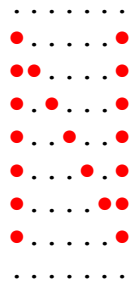

079

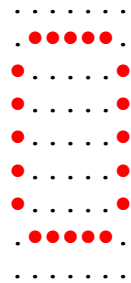

080

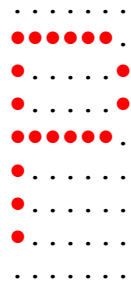

081

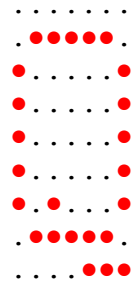

082

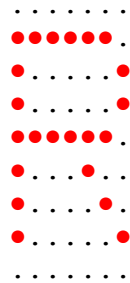

083

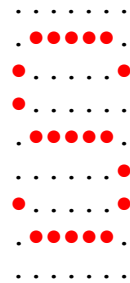

084

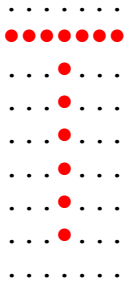

085

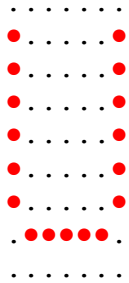

086

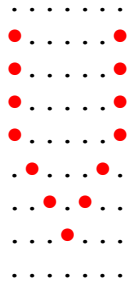

087

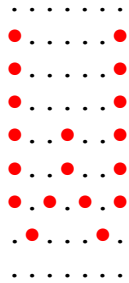

088

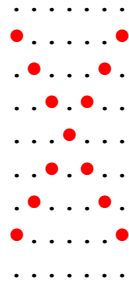

089

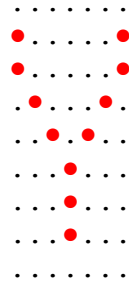

090

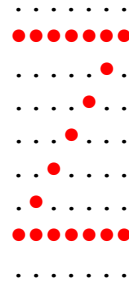

091

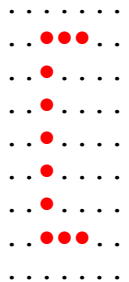

092

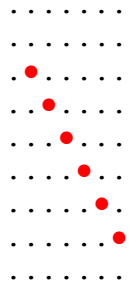

093

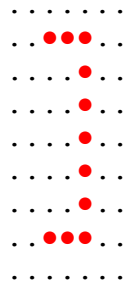

094

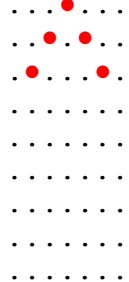

095

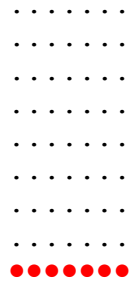

096

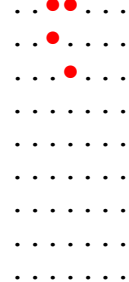

097

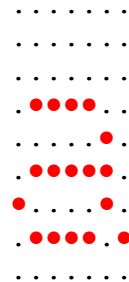

098

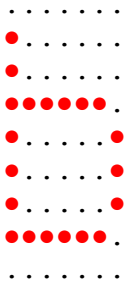

099



100

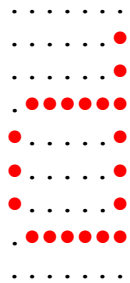

101

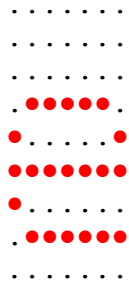

102

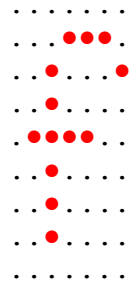

103

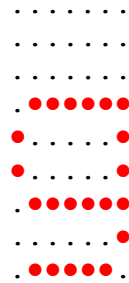

104

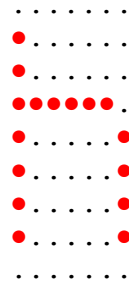

105

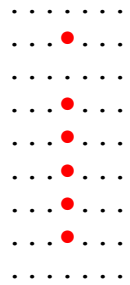

106

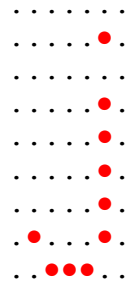

107

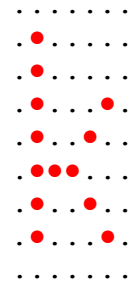

108

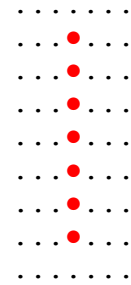

109

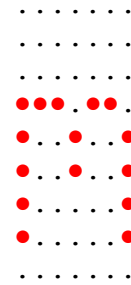

110

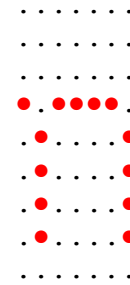

111



112

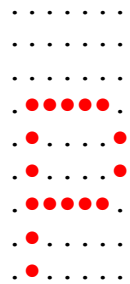

113

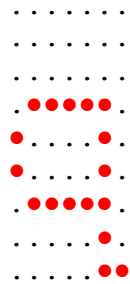

114

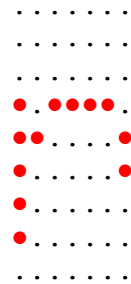

115

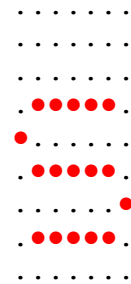

116

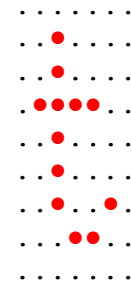

117

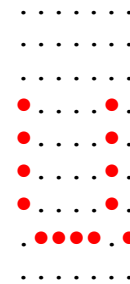

118

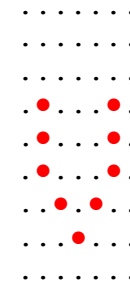

119

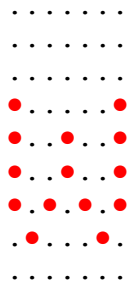

120

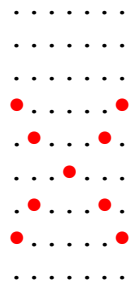

121

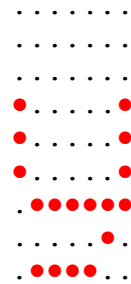

122



123

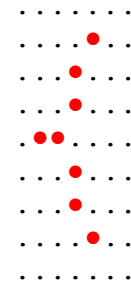

124

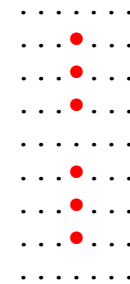

125

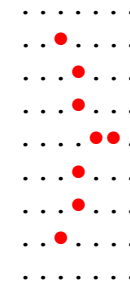

147

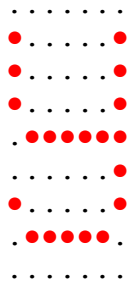

148

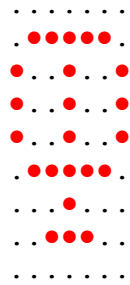

149

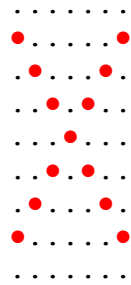

150

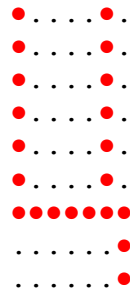

151

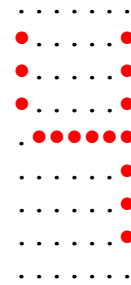

152

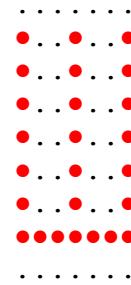

153

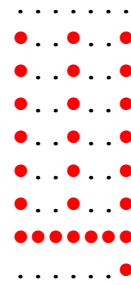

154

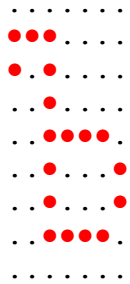

155

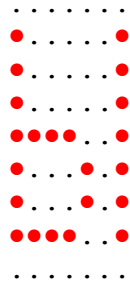

156

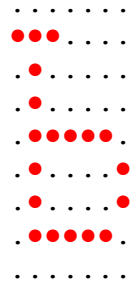

157



158

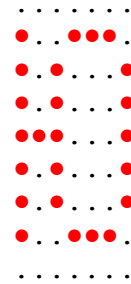

159

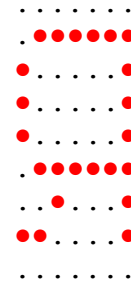

160

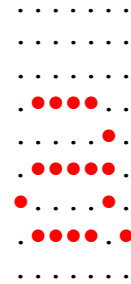

161

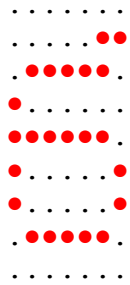

162

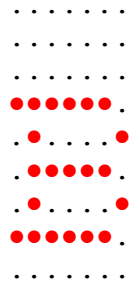

163



164

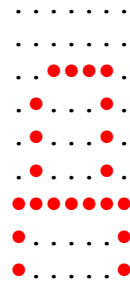

165



166

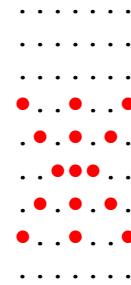

167



168

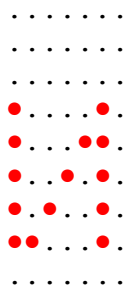

169

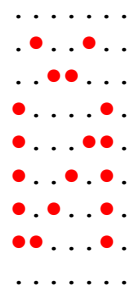

170

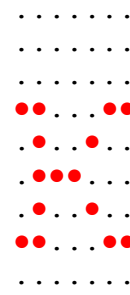

171



172



173



174

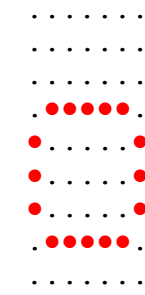

175

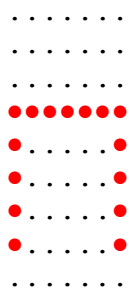

176

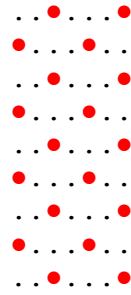

177

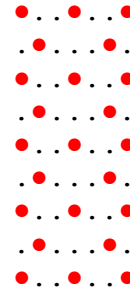

178

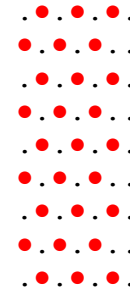

179

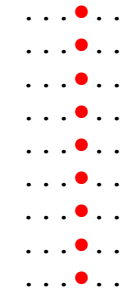

180

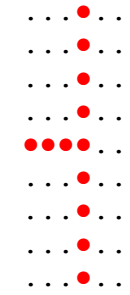

181

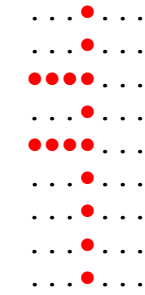

182

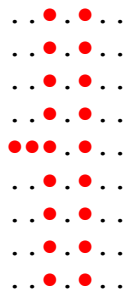

183

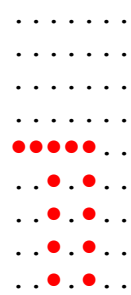

184

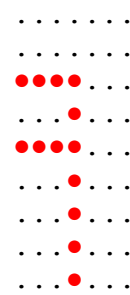

185

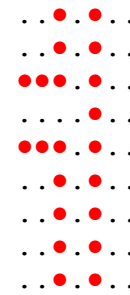

186

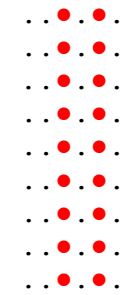

187

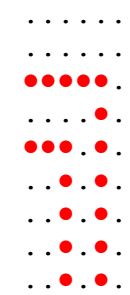

188



252

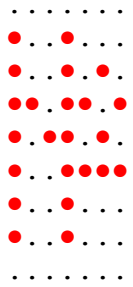

253

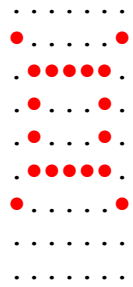

254

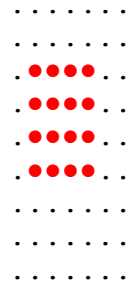

255

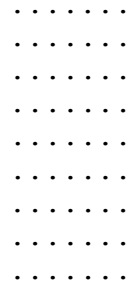

Chapter 5: Service

Safety Requirements

Carefully follow these safety requirements before servicing the Retail Display:

Warning: This device does not contain any user serviceable parts and should only be serviced by a qualified service technician.

Caution: Before servicing the display, disconnect the AC power cord from the retail terminal or PC to which the display is connected. Also disconnect the cables from the PC/terminal to the display.

Caution: For continued protection against risk of fire, replace only with the same type and ratings of fuse.

The fuse is designated F1 in the Vacuum Fluorescent Display.

Pour prévenir et vous protéger contre un risque de feu, remplacer la fusible avec une autre fusible de même type, seulement.

Caution: The power supply cord is used as the main disconnect device. Ensure that the socket outlet is located/installed near the equipment and is easily accessible.

Le cordon d'alimentation est utilisé comme interrupteur général. La prise de courant doit être située ou installée à proximité du matériel et être facile d'accès.

Caution: This device should only be powered by a (SELV) Safety Extra Low Voltage power supply source with an available power level of 5 amperes or less, and suitable for the country of installation. The power source must be certified by the appropriate safety agency for the country of installation.

Le matériel doit être reliés électriquement au circuit à Très Basse Tension de Sécurité (TBTS) ayant une limite de 5 ampères correspondant de façon satisfaisante et acceptable dans le pays où le matériel doit être installé. Le source d'alimentation doit être approuvée par une agence de normalisation appropriée et acceptable dans le pays où le matériel doit être installé.

Servicing the Display

Warning: Before servicing the equipment plug your safety strap into a proper grounding outlet. Failure to do so could damage the equipment.

Normal Operation

On power-up, the unit displays the firmware part number for 2 seconds, then lights all pixels for 2 seconds, then goes blank and awaits commands from the host.

Troubleshooting Procedures

The NCR 5972 Customer Display requires minimal maintenance. Should the display malfunction, adhere to the procedures in the following troubleshooting chart.

Symptom	Probable Cause	Solution
Blank screen on power-up	No power to unit	Check for faulty connections
		Check power source to power supply
		Check for damaged cables
		Check connections
On power-up unit lights but does not communicate with host	Bad cable connections to host port	Check connections
		Misconfigured host

Servicing the VFD or LCD

If the unit still does not perform properly, you need to replace the display. Before disassembly, verify if your model has the labeling and serial numbers indicated on the rear of the cover of the display or on the bottom of the cabinet. This cover must be retained when replacing the display.

Do **not** replace this cabinet with a non-serialized cover.

Caution: Be careful not to damage screw holes or cables when replacing the display.

If you are replacing the display having a serialized cover proceed as follows:

1. Remove **only** two cabinet screws.

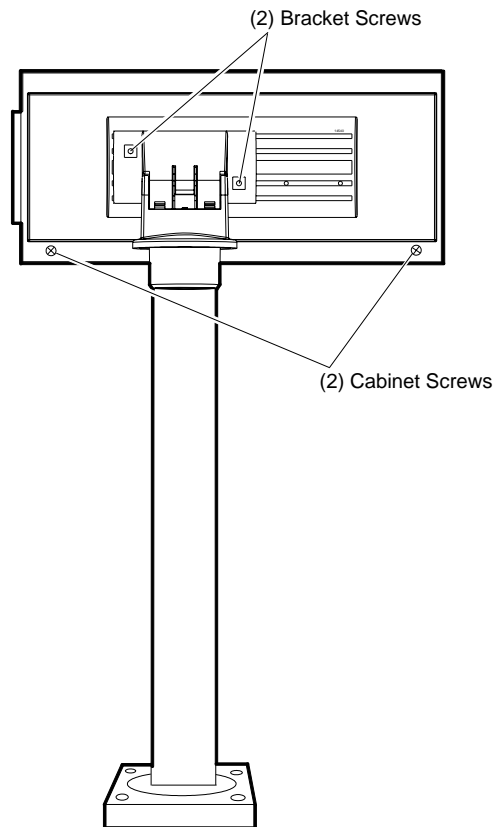

2. Remove the PC board.
3. Disconnect the board from the 24-position connector.
4. Reinstall a new PC board.
5. Route the cable.

VFD: Pull the cable down so the strain relief becomes flush with the housing.

LCD: Route the cable through the strain relief guides located in the cabinet.

6. Replace the cover and secure it with cabinet screws (2).
7. Reassemble the faulty board and mail it to NCR Customer Services for repair.

Note: If you are replacing a non-serialized unit, you may remove all screws (4) or disassemble the display in whatever method is easiest for you.

Cleaning the Display

Remove power from the unit before cleaning.

When cleaning is required, a soft cloth dipped in a mild detergent can be used to clean the cabinet. Only a damp cloth is required so that no moisture can enter the cabinet. Never spray the cleaner directly onto the unit. Care should be taken not to scratch the lens during cleaning.

Note: No preventive maintenance is required to meet the Service Calls per Machine per Year requirement.