

SCHEMATIC

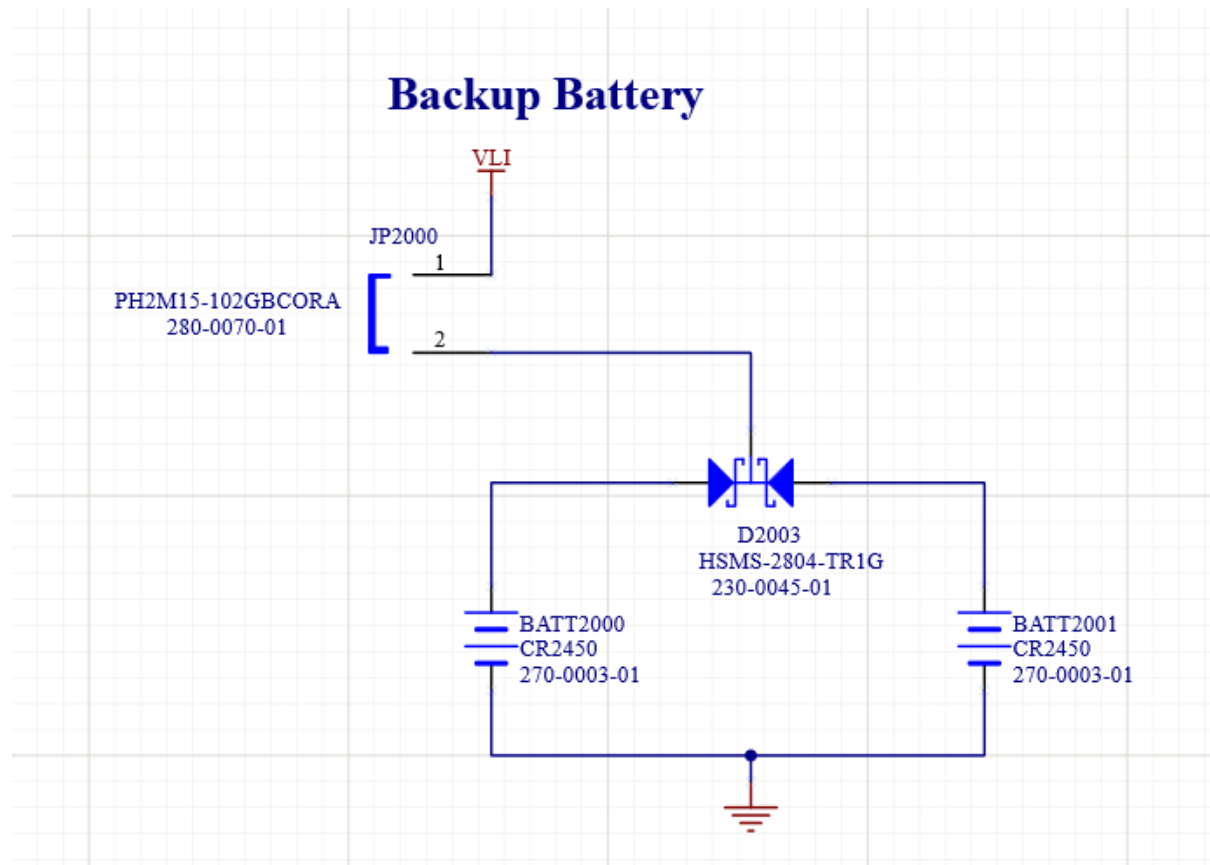

PCB design

PCB design with the long leg

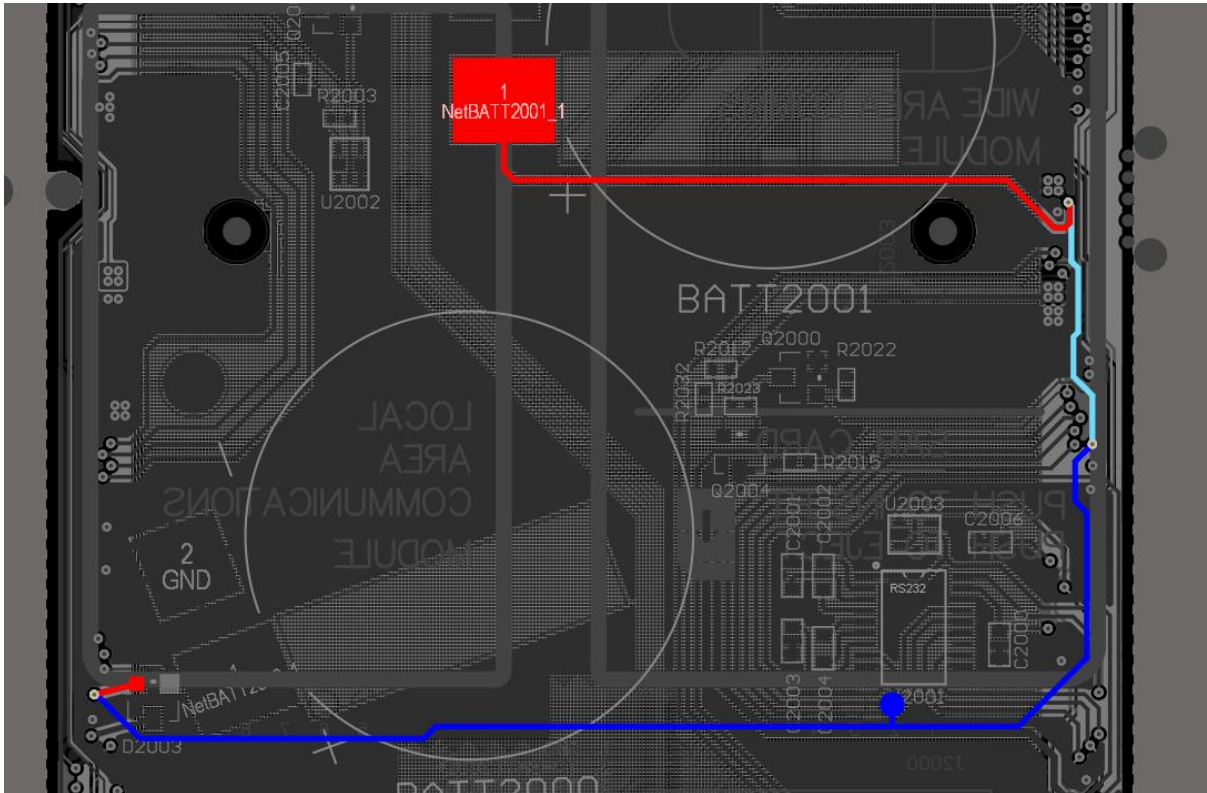

PCB design with short led

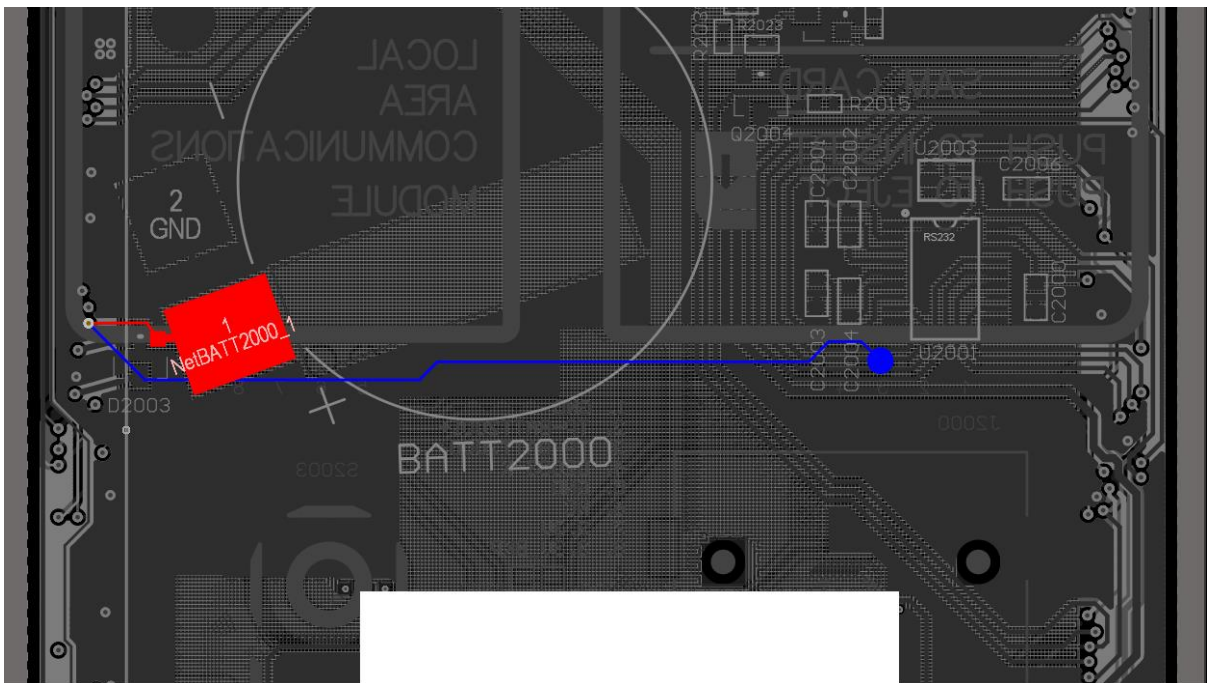

Diode to Jumper

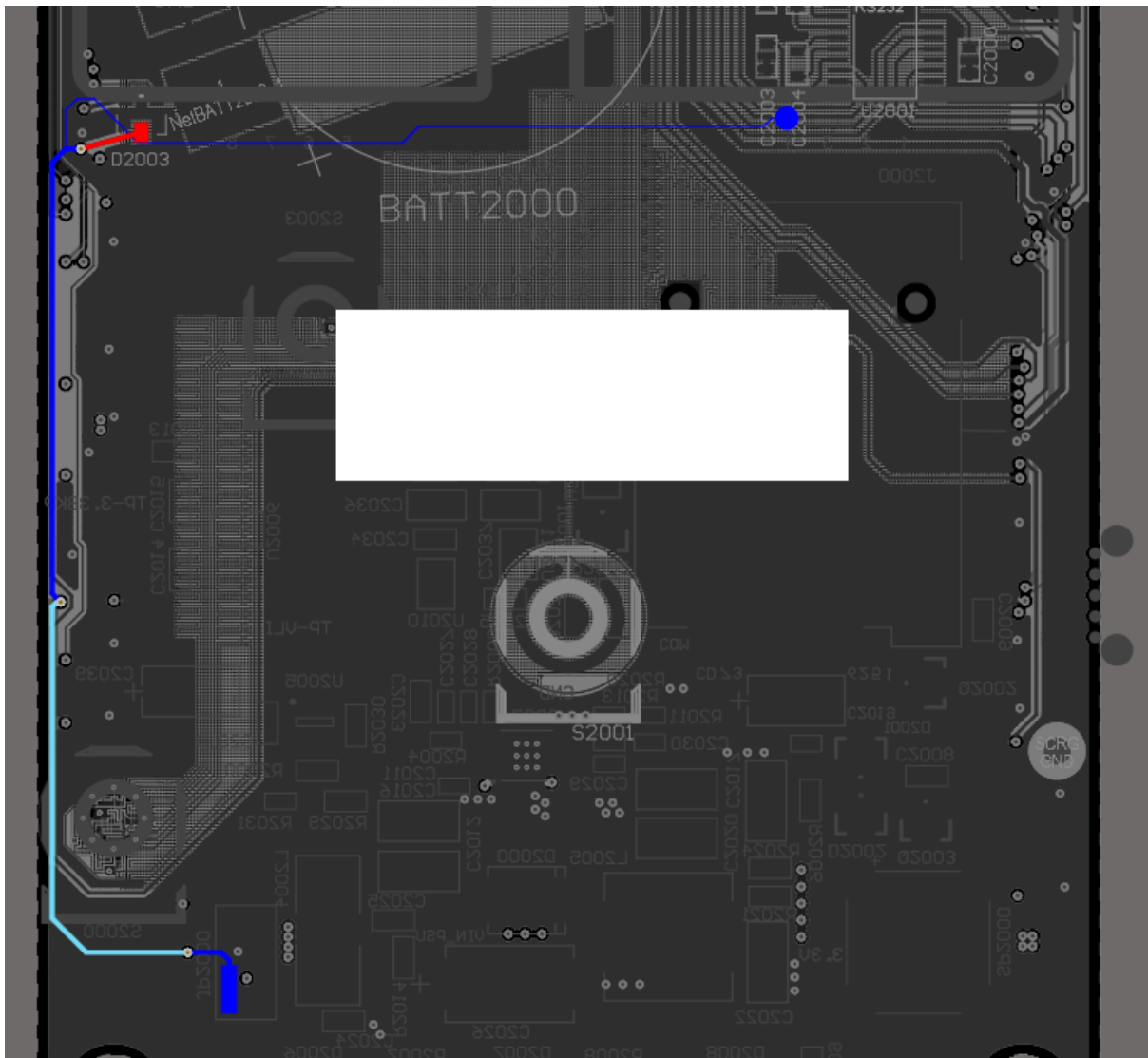

Pictures:

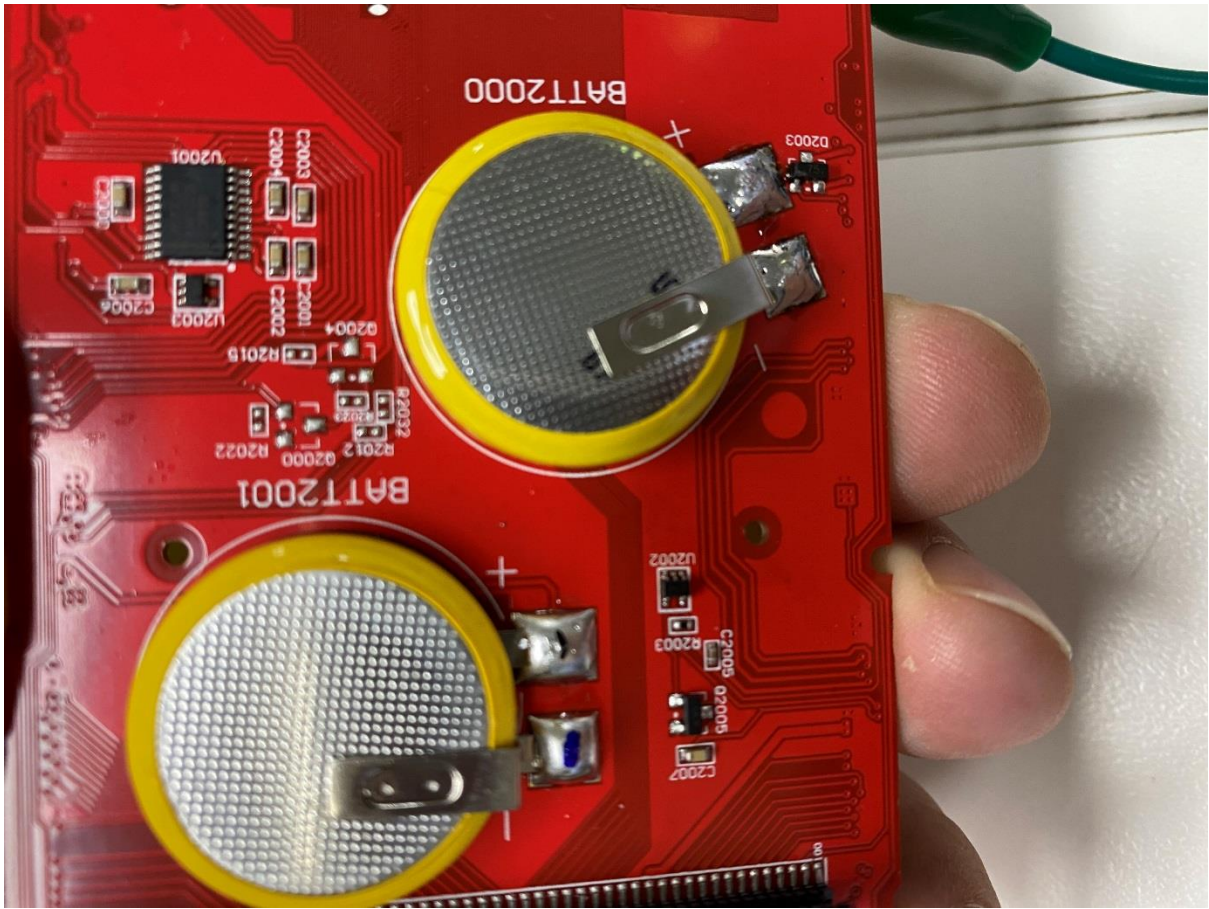

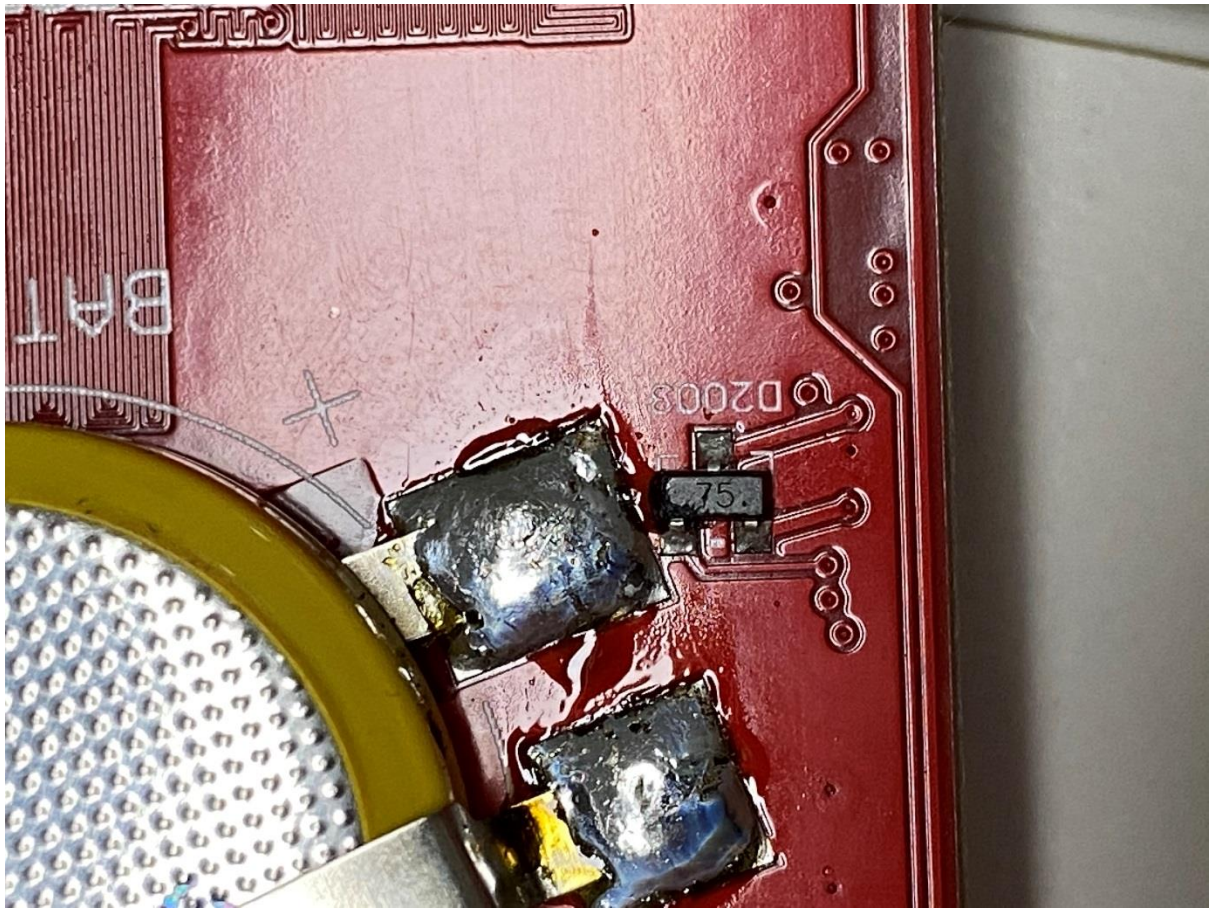

Metal stripes that are soldered onto the PCB making contact to Battery

D2003 – Diode(s)

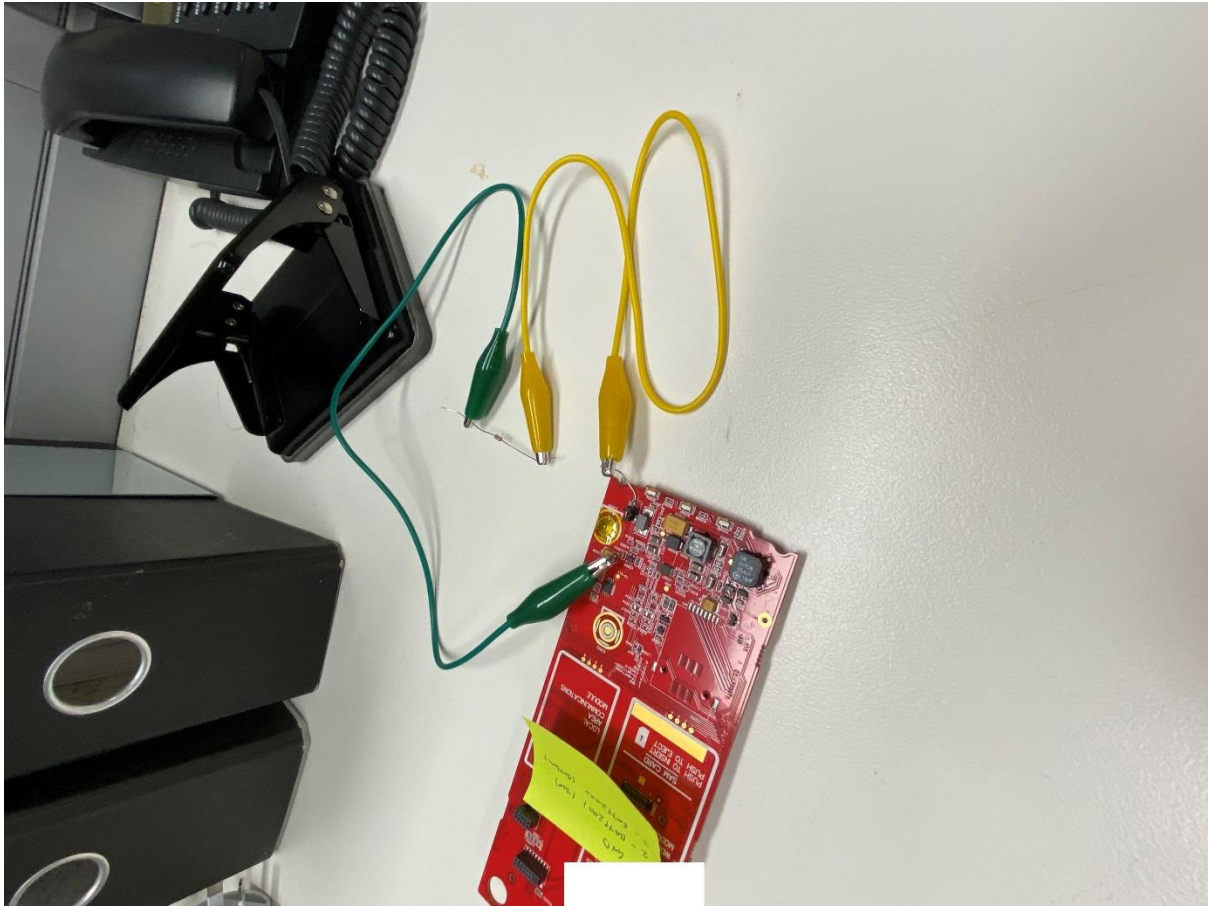

- Green cable going to GND
- Yellow cable going to the jumper