

Schottky diodes selection guide

For **HIGH SENSITIVITY , ZERO-BIAS** or **LOW BARRIER** applications
 --- for lab detectors as RF detector with sweep generator
 --- RF fields detector, electromagnetic pollution, TAG , etc...
 --- passive or active mobile phones and bugs detector

diode TSS (tangential sensitivity)	Glass case	SMD case	Ceramic or special case
-59 dBm @ 2 GHz -55 dBm @ 10 GHz usable up to 18 GHz	these are the much sensitive diodes at ZERO BIAS		
-53 dBm @ 2 GHz -55 dBm @ 6 GHz	ND 4991 - 1SS276 LOW BARRIER	HSMS 2850 - 2851 SMS 7630	DDC2353 up to 20 GHz
from -54 dBm to -52 dBm up to 24 GHz depending on type		all BAT 15... types are LOW BARRIER high sensitivity various types available	
-56 dBm @ 2 GHz with bias	HP 5082-2824	HSMS.282...series	
low barrier, up to millimeter freq.			beam lead version
version with leads of the famous 1N21 - 23	1N821 point-contact silicon , up to 5 GHz		

NOTE : high sensitivity silicon or germanium diodes for detectors are available too, see VARIOUS DIODES

for : RECEIVING MIXERS - RF DETECTORS - SAMPLING

freq.	config.	glass case	SMD or plastic case	ceramic case
up to 500 MHz		BAT 42 - 43 - 46 - 48 - 85 - 86	BAS 40-... - BAT 64-...	
up to 2 GHz	single	5082.2800 - BAT 45 - 82 - 83 HSCH 1001	HSMS 28.... , BAT 68	
	pair	5082.2804	BAS 70... , HSMS 28...	
	quad	5082.2836	ND 487C1-3R	
up to 3 - 5 GHz	single	5082.2810, 2811, 2817 2824, 2835, 2900, MA4853 ND4991 1SS154 ,BA 481, QSCH 5374	HSMS 2810 , 2820 BAT 17 , BAT 68	
	pair	5082.2826, 2912	HSMS 28....	
	quad	HP 5082.2815, 2826	HSMS 2808	HP 5082.2830, 2831, 2231
up to 6 - 12 GHz	single		DC 1501EP - HSMS 2850 - 2851 BAT15... various types, BAT62-03W-02W	DC 1501E (max 18 GHz)
	pair		BAT 15-099 , BAT 62....	BAT 15 099 – MA4E 501
	quad		HSMS 8207 + 8209	HP5082.2277, HSCH 6812
up to 18 GHz	single			5082-2202, 2751, DC1304A, DH363
	pair		HSMS 8202 - MA4E1245	(2 sel. diodes) MA4E522, DH 340
up to 24 - 30 GHz	single			BAT14-104 , MA4E 920 , MA40133 + BAT14-B beam lead case
> 20 GHz for bonding beam - lead case		single: HSCH 9101 , DC 1308 , HSCH5340-DMB2856 , MA4E 2037 , BAT14-110S antiparallel: HSCH 9251, MA4E 997 pair: BAT 14-050D, 090D, BAT 15-090D, HSCH 5531 --- quad: MA4E400H		

FREQUENCY Vs. CAPACITANCE

the graph indicate the operating optimal frequency range of a SCHOTTKY diode in relation to the of junction capacitance. The area between in the two curves is the recommended range of max. junction capacities for the desired frequency.

For example at 4 GHz the optimum junction capacitance is ≤ 1 pF. Lower junction capacities (so better diode performances) can be obviously used even if it not lead to significant improvement.

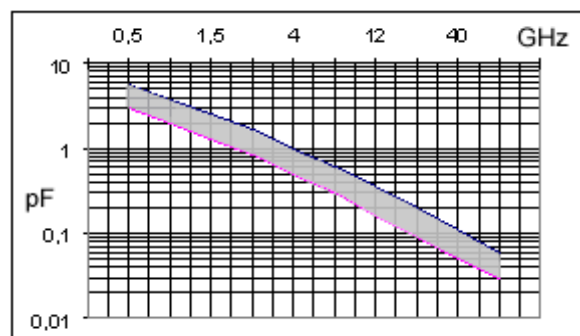

glass case single diodes

CJ pF	VR V	VF V	CJ @ ØVR , CJ decreases a lot with bias or local oscillator VF @ 1mA NB typical values	cod.	price € each			
					1+ pcs	4+ pcs	10+ pcs	
2.2	60	0.38	they are similar types , up to 2 GHz suitable as detector and up to 1.5 GHz as mixer, HSCH1001-1N6263-SD101A are used also as protection for RX input in HF and VHF frequencies due to their low capacitance and low switching time	HSCH-1001 = 1N 6263	0,70	0,65	0,60	
2.2	60			SD 101A	0,70	0,62	0,55	
2	70			5082-2800 1N 5711	1,70	1,60	1,50	
1.2	20	0.36	general purpose, mixer and detector diode up to 3 GHz, it is also available in some SMD versions HSMS 281... type or with glass case 5082-2811	5082-2810	--	--	--	
1.2	15	0.37	general purpose, mixer and detector diode up to 3 GHz	5082-2811	2,90	2,80	2,70	
1	15	0.35	this diode is a very good mixer and detector, it dissipates up to 1/4W to 200 °C, low Flicker noise 1/F with bias 20 uA and high Tss sensitivity -56dBm / 2GHz see AN hp 923 (HP 11\$)	5082-2824	2,60	2,50	2,40	
1	8	0.34	up to 5 GHz, low noise mixer up to 3GHz = HSMS 282...	5082-2835	2,50	2,40	2,30	
1.2	10	0.33	up to 3 GHz, very good performances as low noise mixer and low 1/F noise, see HP applic. notes (HP list 4 \$)	5082-2900	2,00	1,90	1,80	
5	100	0.33	for HF and VHF frequencies detector , mixer , fast switch, etc...	high voltage	BAT46 (= BAT41)	0,40	0,36	0,33
7	30	0.28		high sensitivity and high current 200 mA	BAT 42	0,30	0,27	0,25
6	30	0.30		high current up to 200 mA	BAT 43	0,30	0,27	0,25
10	40	0.30		high current up to 350 mA	BAT 48	0,30	0,26	0,23
8	30	0.28		high sensitivity	BAT 85	0,25	0,22	0,20
7	50	0.28		high sensitivity	BAT 86	0,25	0,22	0,20
1.4	50	0.38		up to 2 GHz , mixer and detector	BAT 82	0,40	0,36	0,33
1.4	60	0.38	up to 2 GHz , mixer and detector	BAT 83	0,40	0,36	0,33	
1	6	0.35	up to 2-3 GHz , mixer and detector	BAT 45	0,50	0,45	0,40	
1	4	0.35	very good power detector up to 4 GHz, and mixer up to 2.5 GHz	BA 481	0,50	0,45	0,40	
0.7	3	0.26	very good mixer and detector up to 5 - 8 GHz	QSCH 5374	4,80			
0.8	3	0.20	high sensitivity Tss = -55 dBm , suitable for laboratory detectors, it is similar to HP 423-HP8472 detector or as low LO level mixer up to 5 GHz . ND4991 is a good replacement to the input mixer diode for spectrum analyzer HP 141 HP 8554B up to 1.2 GHz and HP 8558 up to 1.5 GHz	ND 4991	5,30	4,90	4,70	
0.7			1SS 276	5,00	4,50	4,50		



IN VETRO

matched pairs and matched quads



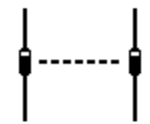

These Schottky diodes are provided as selected pairs, quads or in custom quantities. They are exactly the same as those supplied as single but they are matched to guarantee the same capacitance and forward voltage of all units, they can be used for example as mixers, sampling, multipliers, etc.... For the characteristics please refer to the original code of the single diode eg.: 5082-2836 = single type 5082-2800, those provided in custom matched quantity (2 or more units) have an accuracy within 0.1 pF of junction capacitance and 20 mV of forward voltage in the selection.

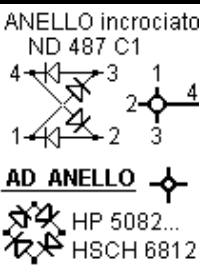
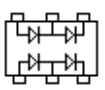

original diode	as provided	cod.	price €
5082-2800	matched pair ΔVF = 20mV	5082-2804	3,60 / pair
5082-2800	custom matched quantity ΔVF = 20mV , ΔCJ = 0.1pF	5082-2836	1,80 / each
5082-2811	matched quad , spare part for sampling probe, HP3406A + Racal RF voltmeters, etc...	5082-2815	13,00 / quad
5082-2811	custom matched quantity ΔVF = 10mV , ΔCJ = 0.1pF	5082-2826	3,25 / each
5082-2900	matched pair ΔVF = 30mV (HP list 8,50 \$)	5082-2912	4,10 / pair

Matched quads in a single case (ceramic or SMD)

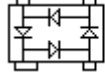
These Schottky diodes, unlike to those reported in the previous page, are provided only as quad configuration but in a single case, of course they are internally matched quads

	configuration	Cj pF	VR V	VF V	CJ @ ØVR , CJ decreases a lot with bias or local oscillator VF @ 1mA typical values	cod.	price € each		
							1+ pcs	4+ pcs	10+ pcs
 <p>ANELLO incrociato ND 487 C1</p> <p>AD ANELLO</p> <p>HP 5082... HSCH 6812</p>	ring cross-over	1		0.2	low barrier up to 2 GHz , cross-over ring , Nec ND-487C1-3R	ND 487C1	3,00	2,85	2,65
	ring (normal)	0.4		0.35	up to 10 GHz Ct max 0.5 pF, ceramic case	5082-2277	3,50	3,30	3,10
		0.5		0.4	up to 3 GHz , ceramic case	5082-2830	6,40		
		0.5		0.25	up to 3 GHz, low barrier, ceramic case	5082-2831	3,50	3,30	3,10
		0.25	4	0.43	up to 12GHz, HI REL hermetic ceramic case	HSCH-6812	16,00		
 <p>HSMS 282P</p>	bridge (unconnected)	1	15	0,30	2 couples of diodes in series, each couple has the central tap in bridge quad configuration, for sampling up to 4 GHz or detector and voltage doubler RD 12 Ω , LifeTime 100<pS , ΔVf <15 mV , ΔCj <0.2 pF	HSMS-282P	1,20	1,05	0,90
 <p>HSMS 2829</p>	ring cross-over	1	15	0,30	as mixer up to 4 GHz	HSMS-2829	2,50		
 <p>HSMS 8207</p>	ring (normal)	0.2	4	0,30	CT < 0.26 pF , ΔCT < 0.04 pF dynamic resistance < 14 Ω Δ dynamic resistance < 2 Ω ΔVF < 20 mV , @ 12 GHz 6.3 dB conversion loss typ.	HSMS-8207	4,30		
 <p>BAT..</p>	ring cross-over	0.4	4	0.40	these 2 diodes are pin compatible with HSMS 8209 , except for a little difference in forward voltage	BAT-14-099R	see HSMS-8209		
		0.4	4	0,25		BAT-15-099R			

For microwave - ceramic or plastic case

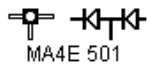

5082-2200
2202
DMK-6635

DH 363
DC1501E
DC1304A
5082-2751

PLASTICO
DC 1501EP

BAT14-104

MA4E522
DH340
MA4E920

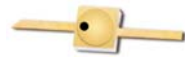

CJ pF	VR V	VF V	CJ @ ØVR , CJ decreases a lot with bias or local oscillator VF @ 1mA NB typical values	cod.	price € each 1 - 10 pcs
0.18	4	0.43	it is the version with hermetic ceramic case of the 2207	5082-2202	16,50
0.1	4	0.43	up to 18GHz , low Flicker noise 1/F with bias 20uA and high sensitivity Tss -55dBm @ 10GHz hermetic gold plated ceramic case	5082-2751	14,50
5082-2207 and 2209 with plastic-ceramic case are replaceable with 5082-2202					
0.25	4	0.4	matched pair , up to 18 GHz , ceramic case	DMK 6635	on request
0.2	3		plastic case for microwave general purpose	DC 1501 EP	3,10
0.1	3		GaAs, NF 6dB @ 10GHz, mixer and detector up to 14GHz	DC 1304 A	5,20
0.22	4	0.43	mixer up to 18 GHz , single diode for cavity mounting	DH 363-04	on request
			mixer up to 18 GHz provided as matched pair with HI-REL ceramic case	MA4E 522M DH 340	18,00 / matched pair
0.3	3	0.3	2 diodes in series with central tap for mixer up to 15 GHz with HI-REL gold plated ceramic case	MA4E 501	8,80
0.13	3	0.42	mixer up to 24GHz and detector up to 30GHz, harmonic mixer up to 33GHz (see VHF Comm. 3-95) chip ceramic case	BAT 14-104	21,00
			ceramic case specified up to 24 GHz with NF<7.5dB recommended for mixers up to 30GHz	MA4E 920-276	22,00
0.1	3	0.3	see description on the next page	MA4E 2502L	on request
0.2	4	0.21	ZERO BIAS suitable as detector up to microwave freq.dc- 20 GHz high sensitivity, HI-REL hermetic gold plated ceramic case (case 240) , TSS -52 dBm former Alpha DCC 4717 (now Skyworks DCC 2353-240)	DDC 2353	1 - 3 pcs 5,90
					4 - 9 pcs 5,40
					10 + pcs 4,90

Comparison with several commercial RF detectors and the Schottky diode DDC 2353

dc output from each type of detectors

RF input level dBm	DDC 2353 zero bias schottky (@ 10 GHz)	Telonic 8554 low barrier schottky (@ 1 GHz)	Suhner 1001.01A low barrier schottky (@ 1 GHz)	HP 8472A point contact diode #1 -- #2 (@ 10 GHz)	HP 8470B low barrier schottky (@ 10 GHz)	Alfred 1001 point contact diode (@ 10 GHz)
- 30	1.5 mV	0.84 mV	0.41 mV	0.98 mV 0.85	0.7 mV	0.8 mV
-25	4.5 mV	2.1 mV	1.7 mV	2.7 mV 2.4	2.1 mV	2.2 mV
-20	14 mV	8.1 mV	5.5 mV	8 mV 7.3	6.3 mV	6.4 mV
-15	38 mV	19 mV	16.4 mV	22 mV 20	18 mV	18 mV
-10	85 mV	59 mV	43 mV	54 mV 50	4.8 mV	46 mV
-5	180 mV	115 mV	103 mV	120 mV 113	110 mV	106 mV
-0	360 mV	280 mV	226 mV	246 mV 234	233 mV	223 mV
+5	698 mV	503 mV	460 mV	480 mV 460	470 mV	440 mV

Note: the sensitivity of the DDC 2353 diode, judging from the table, would seem to be much higher than very famous and expensive RF detectors, this is due to the fact that commercial detectors are all equipped with a matching network on the diode that causes a loss of about 3 dB compared to our diode that has been tested without a matching network instead. The result is that the real sensitivity of the diodes is quite similar among the various types.

Beam lead diodes substitution with MA 4E 2502L

A cross between microwave ceramic diodes and millimeter beam leads

To achieve high performances in microwave or millimeter frequencies it is common knowledge that is necessary to use beam lead diodes because their package reduces capacitance and parasitic inductance values. However beam lead diodes are extremely fragile and not easy to handle, so specific techniques and sophisticated equipments are needed.



MaCom has developed a cheap glass package with very low parasitic capacitance comparable to those of beam leads, since it is glass made it has a higher strength showing many similarities to beam lead diodes. This package is so robust that (for high volume production) it is provided in reels as normal SMD components, its size is 0502 or 1.1 x 0.46 mm.

Manufacturing takes place with direct overlap of silicon on a glass support with a thickness of only 0.15 mm so with vias with very low series inductance.

We recommend to use these diodes to those who have to replace beam lead diodes for mixers and low barrier microwave detectors. A typical application is the replacement of faulty diodes in spectrum analyzer mixer example of spectrum analyzers, special detectors, etc..., or for all applications up to millimeter frequencies where it is very difficult to replace beam lead diodes, the low parasitic capacitance, typically 0.1 pF, allows the use this diodes up to 25-50 GHz



Low barrier @ 1 mA	0.3 V typ.	0.33 V max	Forward current	max 20 mA
Vb @ 10µA	5 V typ.	3 V min	RF CW incident power	max +20 dBm
Cj @ 0V	0.1 pF typ.	0.12 pF max	Dissipation power	max 50 mW
Series inductance	max 0.8 nH		Rs	12.8 Ω

case	CJ pF	VR V	VF V	CJ @ ØVR , CJ decreases a lot with bias or local oscillator VF @ 1mA NB typical values	cod.	price € each			
						1+ pcs	4+ pcs	10+ pcs	
SOT 143 SOT 23	2	70	0,33	single diode, up to 2 GHz	HSMS - 2800	0,90	0,80	0,70	
HSMS	2	70	0,33	2 diodes in series, up to 2 GHz	HSMS - 2802	0,90	0,80	0,70	
HSMS	2	70	0,33	2 diodes with common anode, up to 2 GHz	HSMS - 2803	0,90	0,80	0,70	
2805	2	70	0,33	2 diodes not connected up to 2 GHz	HP - Agilent version	HSMS - 2805	1,00	0,90	0,80
2815					MaCom version	MA4CS 101E	0,85	0,75	0,65
2825	1.2	20	0,36	single diode , up to 3 GHz	HSMS - 2810	0,85	0,75	0,65	
	1.2	20	0,36	2 diodes in series, up to 3 GHz	HSMS - 2812	0,85	0,75	0,65	
	1.2	20	0,36	2 common anode diodes up to 3 GHz for multipliers, mixers, etc...	HSMS - 2813	1,00	0,90	0,85	
BAT15	1.2	20	0,36	2 diodes with common cathode up to 3 GHz	HSMS - 2814	0,85	0,75	0,65	
099	1.2	20	0,36	2 diodes not connected	HSMS - 2815	on request			
BAT62	1	15	0,33	single diode to 4 GHz Tss -56dBm @ 1 GHz with bias	HSMS - 2820	0,85	0,75	0,65	
	1	15	0,33	2 diodes in series up to 5 GHz , Tss as above	HSMS - 2822	0,85	0,75	0,65	
	1	15	0,33	2 common anode diodes up to 5 GHz , Tss as above	HSMS - 2823	0,85	0,80	0,75	
	1	15	0,33	2 common cathode diodes up to 5 GHz , Tss as above	HSMS - 2824	0,85	0,75	0,65	
	1	15	0,33	2 diodes not connected , Tss as above	HSMS - 2825	0,85	0,75	0,65	
 HSMS 282K	1	15	0,33	2 diodes not connected, it is a version with high insulation between the 2 diodes and central short circuit	HSMS - 282K	1,50			
 HSMS 8202	1	15	0,33	quad with 2 pairs in series with central tap for bridge configuration, quad for sampling up to 4GHz, RD 12Ω, LifeTime 100<pS , ΔVf <15 mV	HSMS - 282P	1,20	1,05	0,95	
HSMS 2802	2.2	50	0,32	up to 2 GHz as mixer, detector or fast switch and limiter, similar to HP-5082-2800 glass type	HSMS - 2840	1,60			
HSMS 2812					(=HSMS 2800)				
HSMS 2822	0.28	2	0,20	SMD version of HSCH3486 , Tss at zero bias - 57dBm @ 1GHz -55dBm @ 6 GHz -- voltage sensitivity Y with -40dBm = 40 mV/μW @ 1GHz and 22mV/μW @ 6GHz Between the 2 models there are no electrical differences, one is connected on the right side the other on the left side of the case. See also SMS 7630-001	HSMS - 2850	2,30	2,15	2,00	
MA4E 1245					ZERO BIAS				
BAT 40-04					HSMS - 2851	2,50	2,35	2,20	
BAT 70-04									
BAT 64-04									
 HSMS 282P	0.22	4	0,29	MaCom	2 diodes in series , mixer and detector up to 14-16 GHz, 6dBNF @ 10 GHz,	MA4E1245KB	3,10	3,00	2,90
BAT 70-06				HP-Agilent	Tss -55dBm with bias 20μA , RD 14 Ω	(= MA4E2054B)			
BAT 64-06					HSMS - 8202	3,10	3,00	2,90	
BAT 40-05	4	40	0,31	general purpose detector up to 500MHz , limiter for RX protection up to 400 MHz	2 diodes in series	BAS 40 - 04	0,25	0,22	0,20
BAT 70-05					2 common cathode diodes	BAS 40 - 05	0,25	0,22	0,20
					2 diodes not connected	BAS 40 - 07	0,30	0,27	0,25
BAT.... 03W	1.5	70	0,35	detector and protection on instrumentation and receivers up to 2GHz, SMD version of the famous 5082-2800	2 diodes in series	BAS 70 - 04	0,40	0,35	0,30
BAT.....098					2 common anode diodes	BAS 70 - 06	0,40	0,35	0,30
					2 diodes not connected	BAS 70 - 07	0,40	0,35	0,30
BAT 15-099	0.4	4	0,4	ring quads for mixers up to 12GHz , BAT15 high sensitivity , BAT14 normal sensitivity. In Matiaz Vidmar's projects they are replaceable with HP5082-2831 up to 3 GHz , and 2277 > 3 GHz because only 2 opposite terminal are used even if the case is different, or see HSMS 8209	BAT 14 - 099R	not available see replacement			
BAS40-07					BAT 15 - 099R				
BAS70-07									
HSMS5									
BAT 62									
HSMS-280...similar to glass types 5082-280....	0.3	4	0,23	LOW BARRIER high sensitivity detector, microwave mixer and detector, suitable also over 20 GHz	BAT 15 - 03W	1,50	1,35	1,20	
HSMS-281...similar to glass types 5082-281....					LOW BARRIER	3,00			
HSMS-282...similat to glass types 5082-2835	0.3	4	0,23	Sot 143 case, 2 BAT15-098 diodes not connected	BAT 15 - 098				
	0.3	4	0,23	up to 5 GHz , good linearity detector up to 3 GHz	BAT 15 - 099	2,50	2,40	2,30	
	0.8	4	0,34	high current up to 200 mA	BAT 17	0,50	0,45	0,40	
	10	30	0,32		BAT 54	0,25	0,20	0,18	

case	CJ pF	VR V	VF V	CJ @ ØVR , CJ decreases a lot with bias or local oscillator VF @ 1mA NB typical values	cod.	price € each			
						1+ pcs	4+ pcs	10+ pcs	
SOT 143 SOT 23 HSMS HSMS 2800-02 2805 2803-10-12 2815 13-14-20 2825 22-23-24 40-50-51 8202 BAS40-04 05 BAT15 099 BAT62 BAT17 MA4E 1245 BAT 54 BAT 68 BAT 64 BAT 64-06 BAT 70-06 SMS 7630	0.4	40	0.43	RF detector max 6-8 GHz see description below	2 diodes not connected single SMD diode, low inductance series ultraminiature SOD 323 case single diode	BAT 62 BAT 62 - 02W BAT 62 - 03W	1,10 1-4 pcs 5-9 pcs 10-29 pcs 30-99 pcs	1,00 1,00 0,60 0,50 0,40 0,30	0,90 0,60 0,50 0,40 0,30
BAT 15 099 BAT 62	4	40	0.32	general purpose up to 500 MHz and suitable as protection, clipper, peak limiter, transient on RF lines	single diode 2 diodes in series 2 common anode diodes	BAT 64 BAT 64 - 04 BAT 64 - 06	0,30 0,30 0,40	0,25 0,25 0,20	0,20 0,20 0,40
BAT 54 BAT 68 BAT 64 BAT 64-06 BAT 70-06 SMS 7630	1	8	0.34	mixer up to 2 GHz and detector up to 4 GHz		BAT 68 SMS 7630-001 (SMS 3994-00) ZERO BIAS	0,70 2,00	0,60 1,85	0,50 1,70
	0.28		0.18	zero bias very high sensitivity , up to 10 GHz, similar to HSMS 285... series, it is the most sensible among zero bias diodes					



HSMS
282K



HSMS 8202
HSMS 2802
HSMS 2812
HSMS 2822
MA4E 1245
BAT 40-04
BAT 70-04
BAT 64-04



HSMS
282P

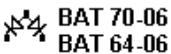

BAT 70-06
BAT 64-06

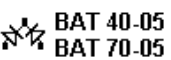

BAT 40-05
BAT 70-05



BAT... 03W



BAT... 098



BAT 15-099



BAS 40-07
BAS 70-07
HSMS5



BAT 62

HSMS-280...SIMILI
AL VETRO 2800

HSMS-281...SIMILI
AL VETRO 2810

HSMS-282...SIMILI
AL VETRO 2835

BAT 62-02W and 03W , low cost schottky detector diodes up to microwave frequencies

BAT 62-03W and 02W are Infineon (Siemens) Schottky diodes for RF general purpose applications, thanks to their very low junction capacitance they can be used as RF detector from LF to microwave frequencies , typical to 6 GHz , and also to 10 GHz if the signal is quite powerful . The SMD low cost case , SOD323 , has a little residual inductance of 2 nH while the BAT 62-02W has a small SMD case SCD 80 and it is suitable for higher frequencies thanks to its very low residual inductance of only 0.6 nH . BAT62 series are also optimal for circuit protection against voltage spikes as clipping or clamping in telecommunications equipment , data line and , thanks to the very low residual capacitance also in front-end for receivers see application note Infineon N° 065 . They are also useful as detector (both forwarded and reflected power) , for high power together with a directional coupler or directly to the RF for signal at medium-lower power thanks to the reverse 40V.

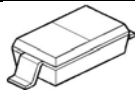
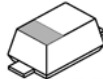
Reverse Voltage	40 V		case SOD 323	BAT 62-03W
Reverse Current	< 10 µA @ VR 40V			
Junction capacitance	typ. 0.35 pF - max 0.6 pF		case SCD80 SOD523	BAT 62-02W
Forward current	max 40 mA			
Forward voltage	0.43 V @ 1 mA			
Series inductance to ground	2 nH 03W -- 0.6nH 02W			

Beam lead - chip DIE for bonding or millimeter waves

ATTENTION : beam lead and die components have nearly microscopic size , in order to mount them you need to use particular techniques like bonding or silver glue , besides a microscope is needed .







CJ pF	VR V	VF V	CJ @ ØVR , CJ decreases a lot with bias or local oscillator VF @ 1mA NB typical values	cod.	price € each 1 - 10 pcs
0.05	4.5	0.68	GaAs, specified for 44 GHz 6.7dBNF, up to 200GHz see Dubus 2-94	HSCH - 9101	26,00
0.05	4.5	0.68	GaAs , double diode HSCH 9101 parallel pair in a single case for sub-harmonic mixer up to 100 GHz	HSCH - 9251	37,00
0.1	4	0.35	up to 30 - 40 GHz, 7.5dBNF@ 26 GHz - Rs < 20 Ω Tss -54dBm @ 10 GHz with 10 µA bias	DMB 2856 (= HSCH 5340)	15,00
0.08	4		GaAs specified for 35 GHz with NF 10 dB	DC 1308	19,00
0.2	4	0.47	Pair connected in series with central tap, Tss -48dBm	BAT 14-050 D	11,00 - 8,50
0.14	4	0.49	Pair connected in series with central tap up to 24 GHz	BAT 14-090 D	16,00
0,1	4	0,50	single diode, it has the lowest residual capacitance of the BAT 14 family, for mixers and detectors up to 40 GHz , 7 dBNF @ 16 GHz OL 0dBm Rs 10 Ω , similar to chip ceramic BAT 14-124	BAT 14-110 S	16,00
0.14	4	0.3	low barrier as BAT14-090D high sensitivity Tss = -53dBm, up to 24 GHz	BAT 15-090 D	22,00 finishing
0.06	5	0,7	GaAs for millimeter frequencies	MA4E 2037	on request
			GaAs for millimeter frequencies	MA4E 2039	on request
0.1	2	0.31	up to 40 GHz , mixer with 7.5 dBNF @ 16 GHz , Rs 18 Ω	MA 40131	on request
0.1	3	0.41	(= HSCH 5312) up to 30 - 40 GHz , beam strenght up to 10 g Very good mixer with average LO level	MA 40133	15,00
0.14	6.5	0.2	high tangential sensitivity -56dBm (without bias) very good low barrier as detector diode for millimeter frequencies = BAT 30 or DCC 2351-24	M2X4147 ZERO BIAS	1 pc = 10,00 50 pcs = 3,80 each
	5	0.6	bridge quad, Cj from 0.05 to 0.25 pF, Macom 906 case	MA 4E 400H-906	15,00
0.1	3	0.3	glass case Surmount type (not beam lead) , see more detailed informations on the previous pages in microwave diodes	MA 4E 2502L	on request
0.15	3	0.45	chip die, up to 26 GHz	BAT 14-B	on request
1	15		chip die similar to 5082-2811 up to 3 GHz ,it is used as mixer in some HP spectrum analyzers	5082-0097	
0.1	5	0,52	Cj 0.07-0.12 pF , up to 100 GHz , Rs 9 Ω , Rd 18 Ω , Fco 253 GHz Aeroflex-Metelics MSS50-146-B10B	MSS50-146	16,00

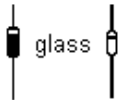

REPLACEMENTS for schottky diodes : BAR10 with 5082-2810 -- BAR 11 with 5082-2810 -- BAR 18 with HSMS-2840
 BAR 28 with HP5082-2800 -- BAR 29 with HSMS-2820 -- BAR 43 with BAT 54 --- BAS 70 with HSMS-2840
 BAS 125-05 with HSMS-2814 -- BAS 125-06 with HSMS-2813 -- BAS 125-07 with HSMS-2825
 BAT 14-03W and BAT 14-098 with BAT 62-03W -- BAT 14-099 with HSMS-8202 or MA4E1245KB if connected in series or antiparallel -- BAT 16 glass case with SMD BAT62-03W -- BAT 17.... with HSMS 282.. with same configuration
 BAT 19 with 5082-2811 -- BAT 41 with BAT 46 -- BAT 47 with BAT 46 -- BAT 64 with HSMS-2840
 BAT 64-04 with HSMS-2802 -- BAT 68 - ... eith HSMS-282... with same configuration

USEFUL INFOS ABOUT VARICAP DIODES

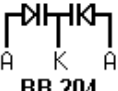
CAPACITANCE RANGE	the minimum capacitance of a varicap diode is reached at the maximum reverse voltage applied (= Vr), the maximum capacitance is reached at 0 V
Q FACTOR Q or Rs	it is the Q (or Rs) factor, some manufacturers indicate the Q factor and other the Series Resistance, the Q is calculable with the formula here reported. Q or Rs are specified at a certain frequency and capacitance value, in the table is written in some cases the <u>Q</u> (underlined number) or the Rs, follows the frequency in MHz at which the measure is done, the last is the capacitance value associated with the measure. $Q = \frac{1}{\omega \cdot R_s \cdot C}$
Vr	maximum reverse voltage available.
Δc	it is the obtainable capacitance variation ratio from the minimum to the maximum applied voltage, i.e. with an applied voltage from 0V to Vr. Varicap diodes with a capacitance ratio Δc < 3 are considered standard, with Δc from 3 to 5 are abrupt type and with Δc > 5 are hyperabrupt type. $= \frac{cap. \max}{cap. \min}$

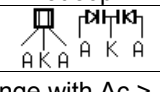
GLASS or PLASTIC	cap. (pF)		Q-MHz-pF or RS-MHz-pF	Vr	C min. at Vmax C max at 0V Vr=Vmax Q expressed as Q factor or series resistance Rs	cod.	price € each		
	min	max					1+ pcs	4+ pcs	10+ pcs
 glass  plastic BB 106 109 209 1S 2208 1T 32 in TO92  BB 112 509 SVC 321 SMV 709  double diode  BB 204 BB 304 KV 1590  SVC 333 for all other diodes the case is in glass	28	65	0.5-30-50	20	HF - VHF , very good also for AFC	BA 111	0,45	0,40	0,35
	2.7	16	<u>100</u> -50-11	28	VHF - UHF provided in couples , 2 matched diodes	BA 142	1,20 / pair		
	6	18	0.8-100-10	25	suitable also for AFC	BB 100	0,50	0,45	0,40
	5	40	0.4-200-25	28	VHF-UHF , guaranteed for a repeatability < 3% among every diode	BB 106 = BB 109G	0,55	0,50	0,45
	15	550	<u>400</u> - 0.5- 500	12	the plastic case is obsolete and no more available, it is replaced with SMD BB 510	BB 112 BB 212	see BB 510		
	18	36	1-200-22	15	HF - VHF suitable also for AFC special offer, minimum buyable quantity 10 pcs	BB 119	0,30 min. 10 pcs		
	2.7	22	<u>200</u> -100-10	28	HF - VHF - UHF , Q specified 100 KHz - 1 GHz	BB 122	0,50	0,45	0,40
	5	35	0.5-470-9	30	replaceable with BB 909	BB 139	see BB 909		
	15	65	0.3-100-38	30	double diode with common cathode, see also the cheaper SMD KV1470	 BB 204 = BB104	0,65	0,60	0,55
	2	18	0.6-470-9	30	VHF - UHF very good Q in UHF	BB 221 = BB521	0,55	0,50	0,45
2.2	18	0.9-470-9	30	VHF - UHF	BB 222	0,60			
2.8	40	0.8-330-12	30	they are 2 versions in different case of the same diode, wide capacitance range Δc > 10 , Q =250 at 300MHz at 3pF Q =180 at 50MHz at 30pF	BB 209 plastic BB 229 glass	0,65			
20	45	<u>200</u> -100-38	30	double diode (values referred to single diode)	 BB 304	0,65	0,60	0,55	
2.8	45	<u>200</u> -20-25	30	HF - VHF , wide capacitance range with Δc > 12 and high Q	BB 329 BB 329A	0,50	0,45	0,40	
2	18	0.75-470 9 pF	30	VHF-UHF up to 2.5 GHz , very good performances and high Q, guaranteed for a repeatability < 3% among every diode	BB 405B = BB 105-BB 205	0,55	0,50	0,45	
2	23	0.6-470-9	28	guaranteed for a repeatability < 3% among every diode, = BB515 and SMD BB535	BB 505	0,60	0,55	0,50	
25	600	<u>200</u> -1-500	12	the plastic case is obsolete and no more available, replaced with SMD BB 510	BB 509	see BB 510			
3	45	0.7-100-12	30	wide capacitance range	BB 609	see BB329 or BB909			
4.5	50	0.5-200-25	28	VHF - UHF , with wide capacitance range, guaranteed for a repeatability < 3% among every diode , = BBY40 cheaper SMD case	BB 809	see BB909			
3	45		30		BB 909	0,50	0,45	0,40	
2.5	40	0.7-100-30	30		BB 910	0,60			



continue

GLASS or PLASTIC	cap. (pF)		Q-MHz-pF or RS-MHz-pF	Vr	for the explanation of the used terms (cap pF - Q - Rs - Vr - Δc) see previous pages	cod.	price € each		
	min	max					1+ pcs	4+ pcs	10+ pcs
 glass plastic  BB 106 109 209 1S 2208 1T 32 in TO92  BB 112 509 SVC 321 SMV 709  A K A double diode  A K A BB 204 BB 304 KV 1590  SVC 333 for all other diodes the case is in glass	2.7	75	1.5-100-40	30	for HF - VHF very wide capacitance range Δc >21, typical >25 , the same of BB640 or SMD BB164	BB 911-911A = BB 531	0,70		
	1.2	4.5	400-50-3.5	22	up to 3 GHz Hyperabrupt very high Q , good performances (Siemens price list 10 €)	BBY 36 Siem.	1,65		
	2.5	30	200-50-9	15	this Fujitsu diode has very good performances like high Q , wide capacitance range 1 - 10 V and very good linearity, in fact it was used in 70 or 140 MHz low distortion modulators on microwave radio links, guaranteed for a repeatability < 3% among every diode	FC 54 Fuji	0,55	0,50	0,45
	6	60	500-1-45	12	high Q , with wide capacitance range within 2 - 10 V	DKV 6510	0,85	0,80	0,75
	32	450	see description	25	linear response Freq/ V tune high Q ≥700 at 10 MHz at 200 pF or Q ≥150 at 50 MHz at 200 pF	DKV 6525	11,80		
	2.8	50	0.9-100-30	30	similar to BB909 and BB910, VHF - UHF , with wide capacitance range	HVS 303	0,50	0,45	0,40
	18	650	300-1-500	20	double common cathode varicap diode with very wide capacitance range even only within 1 - 6 V , narrow tolerance on capacitance variation between diodes typical within 2%, high linearity	 A K A KV 1590 NT	3,20		
	3.5	30	300-50-20		hiperabrupt VHF - UHF, high Δc ratio	MA4ST 520D	1,20		
	2.3	16	450-50-11	22	high Q and performances with thermal stability within 200ppm/°C	MA4ST 533C	1,60		
	25	600	200-1MHz	12	wide capacitance range with only 1-10V and very good linearity / voltage / capacitance / frequency, very good as low distortion modulator	MV 1401	9,50		
	20	90	150-50-40	28	for MW - HF - VHF , similar to MV 2109 and MV 2209	SMV 709	0,70		
	4	26	250-50-15	60	high Q > 250 at +4 V = 15 pF	1N 5142 Mot.	1,90		
	3	15	450-50-7	30	high Q > 450 at +4 V = 7 pF	1N 5441 A Mot.	1,20	1,10	1,00
	2.2	18	0.5-470-14	28	for VHF UHF VCOs	1T 32	1,00		
	30	65	100-50-40	15	HF - VHF , also for AFC	1S 1658	0,60		
2.5	25	0.8-50-9	28	VHF - UHF , high Δc ratio	1S 2208	0,60			
21	85	100-50-50	15	HF - VHF	1SV 74 =1SV89	0,60	0,55	0,50	
0.7	5.5	150-50-4	28	Hyperabrupt high Q , it is the varicap diode with the lowest minimum capacitance, very good for UHF and 2.4 GHz VCOs	1SV 183	0,80	0,75	0,70	

continue







cap. (pF)	Q-MHz-pF or RS-MHz-pF	Vr	case	for the explanation of the used terms (cap pF - Q - Rs - Vr - Δc) see previous pages	cod.	price € each					
						1+ pcs	4+ pcs	10+ pcs			
1	15	3 - 470 - 9	30	Sod 323	for VHF – UHF, wide capacitance range and good linearity	BB 131	0,45	0,40	0,36		
2.6	102	2.8-100-30	30	Sod 323	HF - VHF, very wide capacitance range Δc > 40, every diode is guaranteed for a repeatability within < 2 %	BB 147	0,50	0,45	0,40		
3	80	1.4-100-30	30	Sod 323	varicap diode with a wide capacitance range Δc > 25 , they are suitable for very wide band oscillators, for HF and VHF	BB 164	0,45	0,40	0,36		
						BB 640	0,45	0,40	0,36		
1.8	18	0.7-470-9	30	melf	VHF-UHF similar to BBY31 but with higher Q	BB 215	0,45	0,40	0,36		
25	600	200-1-500	12	Sot 23	high Q from 1 to 100MHz it is the SMD version of BB509 and BB112	BB 510	1,00	0,95	0,90		
2	22	at 470MHz 0,5 Ω 9 pF	30	123	for VHF - UHF , very good Q	BB 515 = 721	0,45	0,40	0,36		
				323		BB 535 = 721S	0,45	0,40	0,35		
3.2	85	1.3-100-30	30	Sod 123	MW-HF-VHF very wide capacitance range Δc > 20	BB 620	0,50	0,45	0,40		
2,7	50	0.8-470-25	30	Melf	HF - VHF - UHF, replaceable with BB729S but with different case	BB 629	see BB729S				
2.6	45	0.6-100-12	30	Sod 123		BB 639					
2,7	48	0.8-470-25	35	Sod 323	HF - VHF - UHF , the same as BB639 with Sod123 case	BB 729S = BB729	0,50	0,45	0,40		
1	10	1 - 470 - 9	32	123	VHF - UHF , for VCOs up to 3 GHz	BB 701 = 601	see BB 833 or BB 835				
1	12	1 - 100 - 9	30	123		BB 811 = 831					
20	70	0.2-100-38	18	Sot 23	common cathode double varicap diode, high Q, HF VHF		BB 804	0,70	0,65	0,60	
0.7	12	1.8-470-9	30	323	fro VCOs up to 3,5 GHz	interesting article on VHF Communic. 4-98 and on Microwave Journal 6-99	BB 833	0,45	0,40	0,36	
0.6	11	2.4 - 470 9 pF	30	Sod 323	with very low minimum capacitance, high Δc ratio for VCOs up to 4GHz		BB 835	0,80	0,80	0,80	
0.55	11	1.5 - 470 2.5 pF	30	SDC 80	miniature case with very low series inductance < 0.6 nH suitable for VCOs even over 4 GHz		BB 857	0,50	0,45	0,40	
1.8	18	a 470MHz 1 Ω a 9 pF	30	Sot 23	single diode		for VHF - UHF , it is available also in single melf case melf as BB 215	BBY 31	0,45	0,40	0,36
					common cathode double diode			BBY 39	0,50	0,45	0,40
4.3	43	0.5 - 200 25 pF	28	Sot 23	VHF high Q, it is the SMD version of BB 809 and BB 909 with glass case	BBY 40	0,45	0,35	0,30		
								30 - 99 pcs	0,25		
								100-299 pcs	0,20		
2.7	43	0.7-100-30	30	23	VHF - UHF wide capacitance range	BBY 42	0,50	0,45	0,40		
2.6	7.5	0.37 1 GHz - 5	7	Sot 23	common cathode double diode		for low voltage VCO max 6-7V up to 3 GHz	BBY 51	0,50	0,45	0,40
				Sod 323	single diode			BBY 51-03W	0,45	0,40	0,35
1	2	0.9 1 GHz - 1.8	7	Sod 323	for low voltage VCOs max 6 - 7 V up to 3GHz , it is the single diode version of BBY 52	BBY 52-03W	0,50	0,45	0,40		

continue

	cap. (pF)		Q-MHz-pF or RS-MHz-pF	Vr	case	for the explanation of the used terms (cap pF - Q - Rs - Vr - Δc) see previous pages	cod.	price € each		
	min	max						1+ pcs	4+ pcs	10+ pcs
see pictures on the previous page	1.9	8.5	0.47-470-5	15	min	very low series inductance miniature case and very high Q, suitable also for low voltage VCOs	HVC 369 B Hitachi	1 - 3 pcs	0,45	
	10	90	0.43 Ω 100 MHz 55 pF	18	Sot 23	high Q , common cathode double diode for HF - VHF, its great feature is a wide capacitance range even with only 1 to 5V, suitable for low voltage VCOs	 KV 1470 Toko	10 - 29 pcs	0,35	
	2.5	30	$\frac{250}{12}$ - 50 pF	22	Sot 23	Hyperabrupt with high performances: wide capacitance range Δc >7, 3 - 8V linear tuning, good thermal stability	MA 4ST 124 (MA4ST 402)	0,55	0,50	0,45
	1.8	20	$\frac{250}{10}$ - 50 - pF	22	Sot 23	Hyperabrupt, wide capacitance range Δc >8	MA4ST 401	0,55	0,50	0,45
	14	50	300-50-27	30	23	high Q guaranteed on all the capacitance range 1 - 30 V	MMBV 2108	0,50	0,45	0,40
	0.9	4	1200-50-1.7	15	Sod 323	SMD miniature case, UHF-microwave, high Q	SMV 1104-33 SMV1233-011	1,40	1,30	1,20
	2	10	1000-50-2	15	Sod 323	miniature SMD case, VHF-UHF, high Q	SMV 1104-34 SMV1234-011	1,40	1,30	1,20
	7	80	150-50-10	12	Sot 23	HF-VHF wide capacitance range within 10V	SMV 1204-12 SMV1212-001	1,70	1,70	1,70
	2	28	200 - 50 - 4	12	Sot 23	Hyperabrupt HF - VHF wide capacitance range, common cathode double diode	 SMV1213-004 SMV1204-113	0,90	0,80	0,70
	2.2	18	0.5-470-14	28	Sod 323	very high Q , for VHF - UHF	1T 362	0,70	0,70	0,70

varicap diodes REPLACEMENTS

BA 121 with BA 142 or BB 100 -- **BB 105 and 205** with BB 405 -- **BB 109** with BB 106 --
BB 134 SOD 323 case with BBY 31 SOT 23 case -- **BB 153** with BB 729S -- **BB 139** with BB 909
BB 179 SOD 523 case with BB 515 SOD 123 case or BB 535 SOD 323 case
BB 503 with BBY 31
BB 512 SMD case with SVC 321 TO92 case -- **BB 521** = BB 221 -- **BB 529** with BB 909 or BB 910
BB 535 SOD 323 case with BB 515 SOD123 case -- **BB 545 - 555 - 565** very similar to BB 535 --
BB 601 and 701 with BB 833 or 835 -- **BB 609** with BB 329 or 909
BB 629 with BB 729 (BB 629 has a Mini Melf case , BB 729 has SOD323 case)
BB 639 with BB 619 or with BB 729 -- **BB 644** with BB 729
BB 731 with BB 164 -- **BB 731 and BB 741** with BB 164 or BB 640
CKV 2020-03-099 and 2020-18-099 new Alpha - Sky codes of DKV 6510-A and DKV 6520-12
MV 2109 and 2209 with SMV 709
SMV 1233-011 , 1234-011 , 1212-001 new Alpha - Sky codes of SMV1104-33 , 1104-34 , 1204

MA45988 DVH4742 	cap. (pF)		Vr V	case	microwave varactor	cod.	price €each 1 - 10 pcs
	min	max					
BBY33 	4	12	30	ceram	Rs=0.9 Ω @ 2.4 GHz , for UHF and microwave	BXY 23	4,50
	0.7	2.4	30		at 4V 1.4pF , for UHF and microwave	MA 45988	5,00
MA 46... DVH 3653 	0.2	0.9	30	ceram	high Q = 4000 , Hyperabrupt GaAs varactor for microwave direct oscillators up to X band γ constant = 1.25 (MaCom price list about 9 €)	DVH 3653	on request
	0.3	1.2	22			MA 46470	4,30 - 4,00
MA 46H 070 	0.3	1.3	20	ceram	MaCom 1088 microwave ceramic SMD case, Ga-As hyperabrupt ultra high Q > 4500 @ 50 MHz γ constant = 0.75 suitable for VCOs and microwave oscillators	MA 46H 070	7,20 - 6,40
					Microwave Abrupt tuning varactor , ceramic case	DVH 4742	4,60
MA45066 DVH6731 MA4ST557  	for cavity tuning and microwave gunnplexer				C0V = 1.2 pF -- C0/C20 = 3 -- Vr = 27V	BBY 33	4,50
					C1V = 4 pF -- C4V = 2.2 pF -- C0/C30 > 4.1 -- high Q > 4000 spare part for MaCom MA 87728 gunn-plexer cavity	DVH6731-90	4,40
					C4V = 0.9pF -- C0/C20 = 3.6 -- Vr = 25 V	MA 45066	4,90
					C0V = 7 pF -- C4V = 2.6 pF -- C10V = 1.5 pF -- C20V = 0.8 pF	MA4ST 557	4,40

	Ga-As tuning varactor for millimeter frequencies MA46H014 - MA46H042 MA46580 - CVG7965	BEAM LEAD varactor	on request
---	---	---------------------------	------------

High performance Very High Q Silicon Abrupt Junction Tuning Varactor

Silicon abrupt junction tuning varactors has been designed to obtain the highest Q possible , they may also be used for tuning filters , phase shifters , oscillators , up-converter and low order multipliers. This tuning varactor is a selection of MA45234 MaCom with improved Vb and Q .

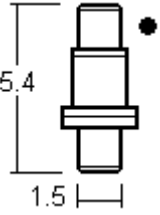
	Q	> 3500 @ 50 MHz -- > 150 @ 4 GHz	cod. MA 45234
	Rs	typ. 0,25 Ω @ 50 MHz Vr = 4V	
	Ratio Ct0/CtvB	> 3.9 -- typ. 5	
	Freq tuning ratio	> 2 :1	
	Capacitance range	typ : 7.5-7.7pF @ 0V -- 3.3-3.5pF -- 1.5pF @ 30V	
	temp. coefficient	typ. 100 - 1000 ppm/ °C	
	Vb	> 30V -- typ 45V	
	Ir	< 20nA @ Vr 25V	
	Vr	> 35V @ Ir = 20μA	
Each diode comes with the test report			

High Cut-off Ga-As Parametric Amplifier Varactor Diode

Gallium Arsenide parametric amplifier varactor diodes offer to the user the highest cut-off frequencies available , to obtain the high cut-off frequency and a non-linear capacitance , a P+ material is diffused into a very thin layer of N type material , with a flag doping profile on an N+ substrate , cutoff frequency is measured as a function using Deloach method .

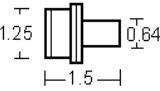
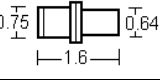
	Alpha case 082-001, Fc @ 0V > 400 GHz -- Fc @ -6V > 900 GHz VR ≥ 30V -- Cj @ 0V 0.30-0.33 pF -- ΔC @ -6V/0V > 0.5 if used as x4 multiplier with Pin +26dBm @ 11 GHz → Pout +22dBm @ 44 GHz	cod. DVE 6822 DVE 6722B
	Thomson case BH10 , Fc @ 0V > 500 GHz -- VR > 15V IR @ -3V < 0,1 μA -- Cj @ 0V 0.2-0.3 pF -- Cj @ -6V 0,13pF ΔC @ -6V/0V > 0.5	cod. AH110-05

An "ideal" pin diode acts as a current controlled variable resistor, the attenuation is independent from power and frequency of use. The performances of a "real" pin diode are limited both by the power level and the frequency, due to a more evident rectification effect at low frequencies. The effect of rectification is simply the normal behavior of a traditional diode in presence of alternate current (RF), but in pin diodes it is a defect that prevents its use at low frequencies.

The choice of a pin diode for low frequencies (short to medium wave <15 MHz) can be very difficult especially when it has to be used on HF receivers front-ends with good dynamic, in fact the diode itself is the cause of unwanted mixing, in this case is wasted the precious and expensive "high dynamic" for the use of a wrong or with poor performances diode, another typical example is in AGC circuits for IF at 70 MHz with TV or digital signals or in instrumentation attenuators and also for AM signals.

Pin diodes suitable for low distortion and usable below 15 MHz are specified with very long lifetime ($\tau > 1\mu S$) so we can say empirically those for low distortion RF attenuators and switches where the rectification effect at low frequencies are more limited.



See Ham Radio back issues, QST 12-94, Ulrich Rohde's various articles and application notes reported on old catalogs of the manufacturers of PIN diodes such as HP, Ma-Com, Alpha, Unitrode to know more about this topic. Below is reported a table in a more practical-empirical than scientific way that helps in choosing the pin diodes.

PIN DIODES - switches - attenuators - limiters

application	frequency	τ or Cj	(τ = lifetime)
Attenuator + AGC low distortion low intermodulation	HF	high lifetime $\tau > 1000$ nS	Linear variation of the Rs vs. bias (typical 3 Ω - 10k Ω)
	VHF - UHF	τ med. lifetime	
Limiter fast switch shunt configuration	HF	CJ < 4 pF	very short lifetime < 10nS
	VHF	CJ < 2 pF	
	UHF + μW	very low CJ	
medium power switch	HF	high lifetime $\tau > 1000$ nS	medium-low Rs, small dissipable power
	VHF-UHF	τ med. lifetime	
high power switch	as above	as above	very low Rs, medium-high dissipable power > 1 W , with glass pin diodes it is easier to obtain good dissipable power just keeping leads a little longer (they act like a heat sink)
phase shifter and modulators	they have to be used as low distortion attenuators		
band switching	they are among the most common low cost diodes used for commercial devices for band switch or antenna switch. If they are used at low frequencies see the above description.		



Cases with suffix 03W or 02W are better for high frequency (> 2,5 GHz) applications

PIN diodes selection guide

	RF attenuator	band switching	low distortion switch	fast switch < 15 nS	AGC	Limiter	power switch	
 G L A S S	5082.3080 MA 47111 BA 389 BA 479 MA4P4006	BA243 BA244 BA282 BA482 5082-3188	5082.3080 MA 47111 BA 423 basso costo uso gener. BA 389	5082.3043 5082.3188	5082- 3080	5082- 3039 3043 3080	BA389 + 479 + 282	2-3 W
							5082-3039 + 3080 + 3188 - MI301	3-5 W
							UM 7006	50 W
							UM 9401	100 W
							UM 9415	1 kW
 S M D	BA 679 - 885 BAR 14-1 e BAR 16-1 > 10 MHz BAR 60 - 61 - 64.... HSMP 380.... 381.... HSMP 3080 - 3081 HSMP 388.... SMP 1304 1SV 271	BA 182 BA 582 BA 592 BA 792 BAP50-03	BAR 14-1 BAR 16-1 BAR 60 BAR 61 BAR 64... BA 595 + 885 HSMP 3880 HSMP 3881 SMP 1304	HSMP 382... BAP 50-03 MA 4P 153 (2 nS) BAR 63.... 1SV 271	HSMP- 3800 BAR 61 SMP- 1304	HSMP 382...	MMBV 3401	3 W
							BAR 63 e 64	3 W
							BA 679 - BA 885	2 W

	Cj	Vb	τ life-time	Trr	diss pow	Rs	W = diode dissipable power, the forward power is greater typical Cj with VR > 3V Rs = series resistance	cod.	price € each				
									1+ pcs	4+ pcs	10+ pcs		
	pF	V	nS	nS	W	Ω							
IN VETRO	2.2	60					very high speed schottky diode Trr <100 pS suitable as protection on RX input or limiter, very robust Vb = 60 V	HSCH 1001 1N 6263	0,70	0,65	0,60		
	0.8	35				0.7	Sod23 plastic case VHF-UHF up to 3 W	BA 182	0,70	0,60	0,50		
	1.5	20				0.7	VHF - UHF general purpose	BA 243	0,35	0,30	0,25		
	1.2	30					VHF - UHF general purpose	BA 243 A	0,40				
	1.5	20				0.4	10 - 1000 MHz general purpose	BA 244	0,25	0,23	0,20		
	1.2	35					VHF general purpose similar to BA182 up to 3 W	BA 282	0,35	0,30	0,25		
	Glass case	0.35	30	\approx 1500			3	used both as variable resistor for attenuators and for switching up to 2 - 3W (each diode) starting from low frequency >2 MHz up to 2 GHz, BA 389 and 479 are similar (see article on Dubus 1-98) Available also in SMD case BA679 - 885	BA 389 (= BA 379)	0,60	0,55	0,50	
		0.5	30	\approx 1500			3		BA 479	see BA389			
	UM 9415 ceramic case	1.2	35					VHF-UHF general purpose similar to BA483-484	BA 482	0,35	0,32	0,30	
0.8		200	4000		1	1	Rs 1 Ω @ 100mA , layer I = 350 μ m very low distortion, suitable for low frequencies either as attenuator and as small-medium power switch	MA 47111 MA4PH 135	7,30				
2		80			1/3	1	very used in RTX portable systems for VHF and UHF up to 5W	MI 301	3,50				
2		30			0.2	0.7		MC 302	3,50				
0.9		600	2500			5.5	1	layer I = 150 μ m low distortion suitable either as attenuator and medium power switch for HF - VHF - UHF max 1.5 GHz , max 50W (US list price 30\$)	UM 7006	7,50			
1.1		50	2000			5.5	0.7	for high power, 100W @ 50°C @ 100 mA it is the typical antenna switch on HF - VHF - UHF systems	UM 9401	6,50	6,30	6,10	
plastico	4	50	5000			10	0.6 Ω at 50 mA 0.1 Ω a 1 A	for MW - HF - VHF - UHF for high power 1 kW @ 50°C @ 1 A very high lifetime \geq 5.000 nS	UM 9415	9,20	9,00	8,80	
	0.3	150	100	100	,1/4	1.2		3 - 5 W 3GHz max , high speed and performances switch (list HP 8 \$)	5082-3039 (= 1N 5719)	4,40	4,15	3,90	
	0.3	50	15	10	,1/4	1.5		3 - 5 W , 3GHz max , ultra-fast	5082-3043	1,50	1,40	1,30	
	0.4	100	1300			,1/4	2.5		5082-3080 (= 1N 5767)	3,40			
	SMD versions are cheaper see HSMP 38... or BAR 64....								low distortion and low intermodulation MW HF VHF for RX high dynamic, see various articles on QST, etc... lifetime = 1.3 μ S \Rightarrow min. freq. = 1.5 MHz	5082-3081	---		
									see 5082-3080 or SMD HSMP381... BAR64...	5082-3081	---		
	1	35	70	12	,1/4	0.6		VHF - UHF band switching , 3 - 5 W	5082-3188	1,40	1,30	1,20	

continue

 
 BAR 64
 3800-10
 3820-80
 BAT 18
 BA 885
 MMBV 3401

 comm. anode
 3813-3823
 BAR 16-1
 BAR63-06

 series
 HSMP 3822-3892
 3802-3812-3822
 BAR14-1

 comm. cathode
 BAR63-05W
 BAR64-05
 HSMP 3894-3804
 3814
 SMP 1310
 SMP 1304-004

 HSMP 4820

 BAR 80

 BAR
 64-07

 case SOD 123
 BA 582

 case SOD 323
 1SV 271
 BA 592
 BAP 50-03
 BAR 63-03W
 BAR 64-03W

 case SDC 80
 BAR 63-02W











 case SOD110
 BA 792

 
 BAR 60
 
 BAR 61

 BA 679

Cj	Vb	τ life-time	Trr	diss pow	Rs	W = diode dissipable power, the forward power is greater typical Cj with VR > 3V Rs = series resistance	cod.	price € each				
								1+ pcs	4+ pcs	10+ pcs		
0.25	50				3	ideal for attenuators up to 3GHz low residual capacitance with linear resistance voltage controlled from 3Ω to 2kΩ , switch up to 2 W , it is also used in some HF transceivers as switch in front-end filters, eg. IC90 switch 5W RF or FT1000 for switch of front-end filters	1SV 271 (= BA 595)	0,90	0,85	0,80		
0.9	35				0.5	same diode, up to 3 W, for frequencies over 30 MHz	SOD123 SOD323	BA 582 BA 592	0,25 0,25	0,20 0,20	0,16 0,16	
0.3	50	1550				low distortion starting from 1 MHz they can be replaced with others with similar lifetime as BAR64... HSMP 3800-381...-388... BA 885, or others with glass case (BAR 64-03W has the same case)	BA 595	see suggested replacements				
0.3	50	1550			BA 596							
0.5	50	2000			BA 597							
0.5	30				3	SMD version of the famous BA479 - BA389 glass case, switch max 2 W, 10-1500 MHz, melf case	BA 679	0,50	0,45	0,40		
0.9	35				0.7	general purpose > 30MHz VHF - UHF SOD110 case	BA 792	0,25	0,20	0,16		
0.3	50	1600			3	very good as variable resistance for attenuators 1 - 2000 MHz and as switch up to 2 - 3 W , very similar to old glass diodes BA 389 - BA 479	BA 885	0,55	0,50	0,45		
0.25	100	1000		1/4	4	common cathode double diode with SOT23 case see SMP 1304-004 or BAR 64-05 or HSMP 3814	BAR 15 - 1	see suggested replacements				
0.25	100	1000		1/4	4	low distortion switch and attenuator	2 diodes in series	BAR 14 - 1	0,75	0,65	0,60	
							2 com. anode diodes	BAR 16 - 1	0,65	0,55	0,50	
0.35	50	1000			3	SOD323 case	BAP 50 - 03	0,70	0,65	0,60		
0.3	50	75			1	fast switch for frequency >30 MHz up to 3 GHz , low series inductance and parasitic capacitance especially 02W type, up to 3W	low series inductance < 0.6 nH SCD80 ultraminiature case	BAR 63-02W	0,60	0,50	0,45	
							single diode SOD323 case	BAR 63-03W	0,50	0,40	0,30	
							2 common cathode diodes	SOT23	BAR 63-05	0,60	0,50	0,45
								SOT323	BAR 63-05W	0,70	0,60	0,55
							2 common anode diodes	SOT23	BAR 63-06	0,60	0,50	0,45
0.3	200	1550		1/4	0.9	low distortion >1MHz switch and attenuator, high IP3, suitable for RTX replacements in HF transceiver in order to improve the dynamic range	SOT23 single diode	BAR 64	0,60	0,50	0,45	
							SOD323 single diode	BAR 64-03W	0,60	0,50	0,45	
							SOT23 2 common cathode diodes	BAR 64-05	0,50	0,40	0,30	
							SOT143 2 diodes not connected	BAR 64-07	1,10	1,00	0,90	
0.25	100	1000		1/4	4	module with 3 PIN diodes for variable attenuators up to 45dB, for instrumentation, IF fast CAG, etc... up to 2GHz see VHF Comm. 1-2001 pag 43	T shaped	BAR 60	2,00	2,00	1,80	
0.25	100	1000		1/4	4		Greek P shaped	BAR 61	1,40	1,15	0,95	





continue

 BAR 64 3881
 3800-10
 3820-80
 BAT 18
 BA 885
 MMBV 3401
 comm. anode
 3813-3823
 BAR 16-1
 BAR63-06
 series
 HSMP 3822-3892
 3802-3812-3822
 BAR14-1
 comm. cathode
 BAR63-05W
 BAR64-05
 HSMP3894-3804
 3814
 SMP 1310
 SMP 1304-004
 HSMP 4820
 BAR 80
 BAR 64-07
 case SOD 123
 BA 582
 case SOD 323
 1SV 271
 BA 592
 BAP 50-03
 BAR 63-03W
 BAR 64-03W
 case SDC 80
 BAR 63-02W

Cj	Vb	τ life-time	Trr	diss pow	Rs	W = diode dissipable power, the forward power is greater typical Cj with VR > 3V Rs = series resistance	cod.	price € each			
								1+ pcs	4+ pcs	10+ pcs	
1.2	35	100			0.5	very good for shunt configuration, very low loss and series inductance, tested up to 2GHz with IF 10 mA @ 50Ω: shunt insulation 23 dB, loss 0,15 dB	BAR 80	1,20	1,05	0,95	
0.8	35	100			0.4	switch and attenuator >10MHz up to 2 GHz	BAT 18	0,40	0,30	0,25	
0.4	100	1800	500	1/4	2	low distortion attenuator and low intermodulation MW - HF - VHF - UHF, they are the SMD version of glass types 5082-3080-3081	single diode	HSMP 3800	0,90	0,80	0,70
0.4	100	1800	500	1/4	2		2 series diodes	HSMP 3802	1,40	1,30	1,20
0.4	100	1800	500	1/4	2		2 com cathode diodes	HSMP 3804	1,00	0,90	0,80
0.4	100	1500	300	1/4	3		single diode	HSMP 3810	1,40	1,40	1,30
0.4	100	1500	300	1/4	3		2 series diodes	HSMP 3812	0,90	0,80	0,70
0.4	100	1500	300	1/4	3		2 com anode diodes	HSMP 3813	0,90	0,80	0,70
0.4	100	1500	300	1/4	3	2 com cathode diodes	HSMP 3814	1,00	0,95	0,90	
0.8	35	70	7	1/4	0.6	VHF-UHF, very good as multiplier up to 6GHz	HSMP 3820	0,80	0,70	0,65	
0.8	35	70	7	1/4	0.6	2 PIN diodes in series, VHF-UHF, similar to glass 5082-3188, very good also as multiplier up to 6GHz	HSMP 3822	0,90	0,85	0,80	
0.8	35	70	7	1/4	0.6	2 common anode diodes, as above	HSMP 3823	1,80			
0.2	50				1.5	triple pin diode in a single case suitable as low distortion switch and RF attenuator		HSMP 386L	0,50	0,40	0,30
0.4	100	2500	550	1/4	0.6	very low distortion even at low frequencies	HSMP 3881	2,00			
0.3	100	200		1/4	0.6	2 pin diodes in series	HSMP 3892	0,90	0,85	0,80	
0.3	100	200		1/4	0.6	2 common cathode pin diodes	HSMP 3894	0,60	0,50	0,40	
0.3	35	200		1/4	2.5	switch and limiter up to 3 GHz, 1nH low series inductance	HSMP 4890	1,00			
1	35			1/4	0.3	VHF UHF general purpose switch and attenuator	MMBV3401LT	0,80	0,70	0,60	
0.3	200	1000		1/4	2	100μm layer I, low distortion switch and attenuator	2 common cathode diodes	SMP 1304-004	0,90	0,85	0,80
0.3	50	200				2 pins common cathode diodes, similar to HSMP 3894	SMP 1310-94	0,70	0,60	0,55	
0.3	50	200				2 pins common cathode diodes, similar to HSMP 3894	SMP 1310-13	2,50			





PIN diodes REPLACEMENTS

BA682 MELF version of BA282 replaceable with BA792
BA979 + BA779 MELF and SMD versions of BA479
BA 892 SCD80 case with BA 592 SOD323 case or BA 582 SOD123 case
BA886 and **BA586** with HSMP 3800 but with different case
BAP63... and **BAP64...** with BAR63... and BAR64...
BAR15-1 with HSMP 3814 or SMP 1304-004 or BAR64-05
BAR17 with HSMP3800
BAR 63 SOT23 case = BAR 63-03W SOD323 case
BAT 18-04 with HSMP 3822 --- **BAT 18-06** with HSMP 3823 --- **DAN235U** with BAR 63-05W
MPN 3401 glass case, the same as MMBV3401 SMD case
MPN 3404 replaceable with cheaper BA.... versions

 case SOD110
 BA 792
 BAR 60
 BAR 61
 BA 679

continue

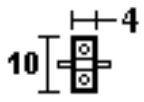
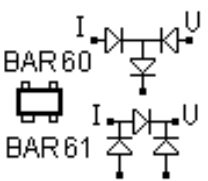
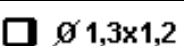
specials , microwave PIN diodes - various - limiters







picture		cod.	price € each 1 - 10 pcs
	Alpha , microwave ceramic case Cj 0.1pF - Vbr 80V Lifetime 80nS , Trr 5 nS	CSB 7002-02	6,80
	DH 50056 70Vbr - Cj 0.2 - 0.4 pF - Rs 1 Ω - Trr 8 nS Lifetime 80 nS , microwave ceramic case 1.3 x 1.5 mm with p.c.b. pins	DH 532	9,20
	30 W max power - 200 W pk 100 MHz - 12 GHz band at 10 GHz : loss < 0.5 dB , insulation > 20 dB	HI - REL versions	on request
		hermetic case	
	variable attenuator up to about 40 dB (depending on frequency) it is made of 3 pin diodes Greek P or T shaped in a single case, up to 2 GHz suitable for CAG circuits, for instrumentation, as modulator, phase shifter etc..., suitable also in HF - VHF and UHF receiver front-end due to its lifetime of 1 μsec. low intermodulation and distortion, interesting low price. see VHF Communications 1-2002	BAR 60 BAR 61	see price of SMD PIN diodes BAR 60 BAR 61
		replaceable with SMD BAR 60 or BAR 61	
	ceramic chip Ø 1.3mm low capacitance for μwave and μstrip Cj 0.1 pF Vb 30 V , lifetime 10 nS , Trr 2 nS , res. 1.2 Ω	MA4P 153-120	5,50
	2-12GHz ceramic case, no specifications available	PIN limitatore	special offer 1,00
	screw mount, up to 500 MHz , no specifications available	PIN di potenza	special offer 1,00
	Reverse Conducting old germanium diode, it was used as protection switch up to X band for radar, for waveguide mounting in old radars	L 4147	on request
	Mini - Circuit LIMITER circuit Limiter stage 0,1 - 150 MHz, typical output level < -1,6 dBm with input from +6 to +20 dBm , relative phase variation within 1°	PLS - 1	on request







-- **STEP-RECOVERY** or **SNAP-OFF** for low power applications or high multiplication > 4 or broadband comb generation, for very fast pulse. The choice of the diode can be empirically determined by the following rules: lifetime > input frequency period. ($\tau > 1/F$ in), transition time < output frequency period ($t_{tr} < 1/F$ out), with step-recovery diodes it is possible to obtain very high multiplication factors and output frequencies up to 26 GHz and beyond.

-- **VARACTOR** generally used for medium and high power multiplication, x2, x3, x4 with high efficiency output typical 60% x2, to 35% x4, they are available in a range from 400 MHz to 18 GHz of output frequency.



In addition to these diodes, born just as multipliers, there are also diodes for other uses with lower performances than step-recovery but at very low cost, eg. for multiplication within 2 to 5 GHz it can be used a varicap and pin or RF schottky matched pairs as frequency doublers and even ultra-fast switching diodes but with $C_j < 1\text{pF}$ and $t_{tr} < 1\text{ns}$, all for low-power applications. For millimeter multipliers >30 GHz are used beam-lead Schottky diodes.

(See articles on VHF Comm 3-1978 and much more interesting on VHF Comm 3-2006)

case	lifetime τ nS	Trr - Tt pS	Cj pF tip -6V	Vb V	STEP-RECOVERY or SNAP-OFF diodes	cod.	price € each 1 - 10 pcs
	6	60	0.2-0.3	15	also for medium power up to 200 mW output	DH 267	on request
ceram chip	> 10	< 70	0.2-0.5	15	up to 20GHz and up to 30GHz with reduced performances, ceramic chip Φ 1.4 x 1.2 , up to 0.5W input , high efficiency with 10GHz output, example : input 1.1GHz + 25 dBm x 9 = out 10 GHz + 15 dBm	DVB 6723 = BXY 18-AB6 = HP 5082-0885	14,80
	35	200	0.9-2	40	optimal output range 2 - 8 GHz , ceramic chip case with strip	DH 252-44	11,50
	50	<170	1.5	35	change level 1.000pC	HP 5082-0112	12,50 - 11,00
	100	225	4	50	replaceable with 5082-0112	HP 5082-0180	---
	> 10	<100	< 0.6	25	= 1N4547	HP 5082-0253	18,00
cer chip	> 10	< 75	0.1-0.5	15	Fc 350 GHz , high efficiency with 10 GHz output	HP 5082-0885	on request
	21	150	1.2	40	also for medium power	GC20151 - 2544 - 8A 1075	12,70
	60	100	1.2	40	Ft 300GHz	8A 1074	12,70
	10	< 100	0.6	25	available both in chip case or with screw dissipation support	8D 2011	17,60
COMB GENERATOR used for instrumentation, military receivers, frequency meters etc... to generate an RF comb up to 18 GHz with input at only 500 MHz \pm 10 MHz , example of wide band spectrum with input at 500 MHz from 0.5 W : up to 4 GHz output +10dBm , 4-8GHz +5dBm , 8-12GHz -5dBm , 12-18GHz -15dBm						HP 33004 A	on request

case	lifetime τ nS	Trr - Tt pS	Cj pF tip -6V	Vb V	VARACTOR or BIMODE diodes	cod.	price € each 1 - 10 pcs
			9 - 18	95	max P in 15W 0.1 - 3 GHz	BXY 19 F - FB	19,40
			20-30	100	max P in 20W 0.1 - 2.5 GHz	BXY 19 GB	25,00
			1.5-2.5	30	max P in 2W 1 - 8 GHz	BXY 21 CA	10,80
			2			D 4852	9,50
	> 30	< 100	1		power diode, thermal resistance 8°C/W	DH 245	16,80
	10	75	0.2-0.5	30	max P in 1W 8-16GHz finishing	DH 292	17,00
		2000	5		power diode	M6B18B-8A1076	13,00
	100	1000	8 - 10	80	max P in 20W max 3 GHz, thermal resistance 12°C/W	VAB811 MA43811	14,00
	50	< 150	1.6		medium power diode	8B 1009 - DH160 - VAB 824A	16,00
	90	< 700	2	80	Ft > 150 GHz , max Pin 6W , at 6GHz typical out 2.5W	VAB 804 EC	15,00

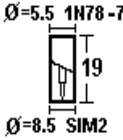
other low cost devices suitable as multiplier						cod.	price € each
PIN diode used as comb-generator, see VHF Comm. 1 - 99						BA 482	see pin and varicap diodes
varicap diode, very good VHF – UHF multiplier, see RR 9-2003						BB 405	
SMD PIN diode usable as low level multiplier up to 6GHz , a HP application note is available on request with the diodes (2 single diodes 3820 or 3822 double)						HSMP 3820 o 3822	
ultra fast switching in glass case, $C_j < 1\text{pF}$ -- $T_{rr} < 750\text{pS}$ -- $V_b > 20\text{V}$ up to 2 - 3GHz						1N 4376	1,20
glass and SMD matched pairs , suitable as x2 multipliers							see schottky
BB 405B - BBY 36 glass case, as multipliers to to 1.5 - 1.8 GHz							see varicap
glass diode for medium power multipling, max 4 W input, up to 1.5 - 1.8 GHz						PC 139 - 1N5142	
DMB 2856 doubler up to 60 GHz , efficiency \approx 7% at 50 GHz , beam lead , see beam lead schottky diodes							

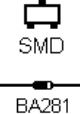
coaxial cartridge	description	cod.	price € 1 - 10 pcs
 <p>Ø=5.5 1N78-76 Ø=8.5 SIM2</p>	up to 15 GHz, used as mixer in old μ wave instruments - detector D 5.5 x19 1N78 is a selection of 1N76 for usage up to 18 GHz	1N 76 A 1N 78	9,80 not available
	Alpha I.	D 4170	11,60
	as above but with reverse polarity (red) finishing	MA 41436R	12,70
	better version of 1N23 up to 15 GHz , D 8.5 x 19	SIM 2	4,00
	medium-high voltage HF IF detector VR 90V I 30 mA VF 0,4V	AA 118	0,50 - 0,45
 <p>glass germanium</p>	very good RF detector with high detection efficiency η 76% VR 30V I max 35 mA VF 0,38V	AA119 - 1N541	0,55
	very good RF IF detector VR 30V I 20 mA VF 0,28V	AA 137	0,50 - 0,45
	high voltage HF RF gold bonded VR 90V and low threshold VF 0,26V	AA 144	0,55 - 0,50
	RF Gold Bonded CJ < 1pF at 1 V - VR 30V - VF 0.25V at 1mA - I 110 mA	AA Y30	0,45 - 0,40
	fast switch and general purpose	AA Z10	0,45 - 0,40
	Gold-Bonded low barrier VF 0.24V VR 75V Cj < 1pF at 1V I 140 mA	AA Z15	1,10 - 0,90
	detector up to 1GHz and fast switch VR 20V Cj 2pF at 1V I 130 mA	AA Z18	1,10 - 0,90
	RF IF detector and HF mixer VR 20V I 50 mA VF 0,28V	OA 73	0,60 - 0,55
	general purpose VR 90V - I 50 mA	OA 95	0,30 - 0,26
	RF IF detector high efficiency η 76% a 10MHz VR 30V I 35 mA VF 0,38V	OA 99	0,70
	Gold-Bonded very good RF IF detector VR 25V - I max 30 mA - CJ < 1,5pF	1N 60	0,55 - 0,50
	for old Telonic and Wavetek instruments, detector for linearization of output signal or mixer, very good detector for high sensitivity probes up to 2GHz VR 35V - I 50mA - CJ 1 pF	1N 82 1S 188	0,85 - 0,75 0,90
	HF IF general purpose detector - VR 50 V - VF 0,5 V - CJ 2,5 pF	1N 3600	0,30 - 0,25
 <p>silicon SMD BA281</p>	glass case, RF detector and low cost mixer up to 1 GHz , Cj 1.2 pF	BA 281	10 pcs = 1,20
	for RF up to 500 MHz and suitable for high voltage up to 200 Vbr	BAS 21 SMD	10 pcs = 1,20
	2 diodes in series with center tap up to 1 GHz , Cj 1 pF , Vb 70 V , Trr < 6 nS very good general purpose detector, switch, protection from transients, min. 10 pcs	BAV 99 SMD	10 pcs = 0,80 50 pcs = 2,80
	2 common anode diodes, see BAV 99 for specifications	BAW 56 SMD	0,23

Gunn and Tunnel diodes

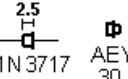
 <p>Gunn TEG... VSA 9210 IU AH 370-374 MA 49337</p>	38-40 GHz 100 mW	30 - 47 GHz 30 mW	Varian 5.5V , 500mA every diode has the test report	VAS 9210 IU	special offer 26,00
	18 - 26 GHz 8 mW	20 - 24 GHz 20 mW	Thomson 4,5 V , 0.5 A	AH 370	26,00
	18 - 26 GHz 60 mW	20 - 24 GHz 150 mW	Thomson 5,5 V , 1 A	AH 374	on request
	13 GHz 60 mW	12 - 14 GHz 40 mW	Siemens	TEG 214	26,00
	13 GHz 2 mW		Siemens	TEG 212	14,00
	7 GHz 1 mW		Siemens	TEG 213	14,00
	12 GHz -- 17 GHz -- 18 GHz MA49337 MaCom				
 <p>tunnel 1N 3717 AEY 30</p>	This Tunnel diode is used as spare part in Tektronix (or other brands) oscilloscopes triggers, or as self oscillator for VHF microtransmitters			1N 3717	9,30
	for microwaves, Ip 1.6mA , Vp 75V , Cj < 1.8pF , Rs < 8 ohm , special ceramic case			AEY 30 D	on request

All the materials generate noise and the noise is proportional to its temperature starting from 0°K (-273°C). The noise depends on the chaotic movements of the electrons, the thermal noise is known as white noise (from optical physics) as it fills the whole spectrum. From an electronics point of view the noise causes big limitations to our devices for example amplifiers, instruments, radars, receivers, electro-medical, etc... A very simple example is the sensitivity limitation of receivers caused by the noise. Although the noise causes problems and limitations, it will be explained how in some cases, if it is artificially generated, it can even improve our electronic devices (see dithering) or help to do some tests, a calibrated noise source is a very important tool in our labs.

NOISE GENERATORS . The first noise generators used noble gas such as Argon with 15.3dBENR, Neon with 18.5dBENR, Helium with 21dBENR and were born in order to test the first radar systems in the 1940s.

Another method to generate noise is to use hot and cold resistors, mainly used in research labs with very high precision, this technique due to its complexity is used only in physic laboratories or in calibration centers. Today the most used noise generators are special diodes, noise diodes. A reverse polarized diode until it reaches the avalanche effect is an example of noise generator (see Zener diodes). Unlike Zener diodes, the noise diodes are doped and developed to cover a wider band (low Cj) with an output level really flat and more stable.

OUTPUT LEVEL For noise source applications the output level cannot be indicated as for other signal generators.

Signal generators, transmitters etc... have the output level indication in mV, dBm, W etc....

If you have a 100 to 200MHz sweep signal generator we say that the output level is for example -10dBm, the amplitude of -10dBm is swept from 100 to 200MHz but it is not simultaneously in the whole frequency range.

In the case of noise sources the amplitude is simultaneously on the entire frequency range, this means that the amplitude is defined in dBm/Hz power spectral density, or in ENR excess noise ratio.

ENR means the ratio in decibel of the output noise between the ON and OFF state of the diode, in the OFF state the diode has only -174dBm/Hz which is the output level generated by a resistor at 290°K (about 17 °C).

For example, if we have a power spectral density of -142dBm/Hz it means that (174 - 142 = 32) so the ENR is 32 dB.

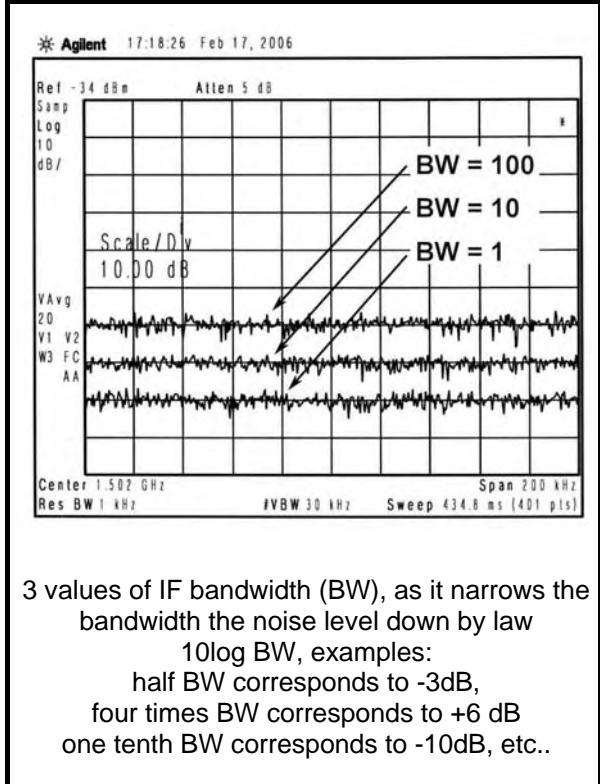

If the bandwidth is 10Hz the noise power is -132dBm/10Hz if the bandwidth is 10KHz the noise power is -102dBm/10KHz.

See the example on the right, in a spectrum analyzer the noise level changes depending on the used IF bandwidth.



Some applications for noise source diodes

<p>DITHERING In an A/D converter for example digital receivers, the noise injected improves the quantization error, the sensitivity will be improved (this method is also used in audio and video).</p>	<p>AUDIO AND ULTRASONIC TEST to find problems of mechanical vibration and reverberation in automotive field, buildings, etc... or for soundproofing tests</p>
<p>NOISE FIGURE MEASURES Test instruments for noise figure measurement in low noise amplifiers, converters, receivers, mixers and front-ends.</p>	<p>SPECTRUM ANALYZER CALIBRATION With a calibrated noise source devices it is very easy to verify the amplitude calibration of a spectrum analyzer, the real advantage is the RF generation simultaneously on all the band.</p>
<p>TESTS ON RECEIVERS The noise is useful to measure the sensitivity in some complex receivers like radars, base stations, radiometers etc... A noise source can substitute for a more complex RF generator, moreover it can generate noise in a broad band spectrum simultaneously.</p>	<p>NPR DISTORTION MEASURES This is a complex intermodulation measurement very often made on multichannels FDM, MMDS, CATV, cellular base stations, etc.. Injecting noise and measuring the distortion with special notch filters is used to obtain the measurement.</p>
<p>FADING SIMULATOR By modulating an RF signal with noise it is possible to simulate a signal affected by fading, this is very useful in mobile radio testing.</p>	<p>FILTERS AND ANTENNAS TESTS using noise as tracking generator tracking</p>
<p>RADIO ASTRONOMY GAIN / BANDWIDTH MEASURES</p>	<p>ELECTROMAGNETIC SUSCEPTIBILITY</p>

case	frequency band	output level	bias	cod.	price €
 SMD sod 323	10 Hz - 3.5 GHz (max 4 GHz)	30 - 35 dBENR -144 / -139 dBm / Hz	8 - 12 V 5 mA	NS-301	28,00
 Cathode BL gold plated ceramic	10 Hz - 8 GHz (max 10 GHz)	30 - 35 dBENR -144 / -139 dBm / Hz	8 - 12 V 8 mA	NS-303	42,00

Tests on noise diodes and advices for usage

- We would point out that the choice of a SMD case (Sod 323 on the model NS 301) was evaluated carefully as the normal version (glass) didn't give us good results regarding the band flatness, with a ripple over 2 GHz definitely not acceptable, while with the special SMD version together with a good mounting you get a better flatness of the output level (see chart below ΔENR NS301).
- With the NS 303 to have a output level flatness it has to be used a good dc-block capacitor on the output, we searched for dc-block 1000pF capacitors particularly suitable for this use and low cost, they are suitable to work until at least 10GHz with a ripple on attenuation <0.5dB over the entire 10 MHz - 11 GHz band, with this capacity value the cut off frequency of the dc-block (minimum freq.) is about 5 MHz, see Capacitors sections up to 40 GHz Ultra Wide Band cod. CCB-1N.

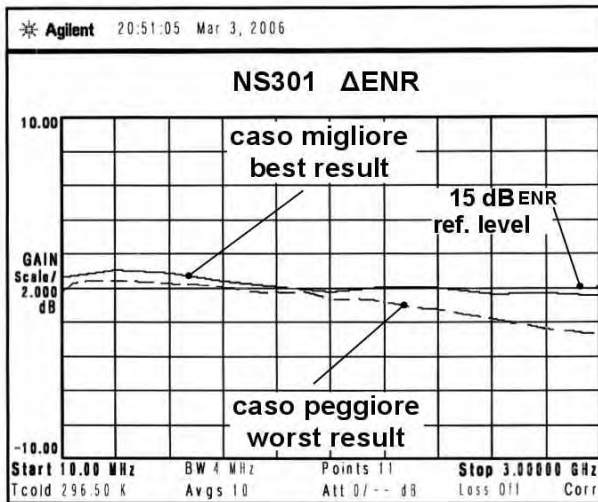

Freq. start 10 MHz -- Freq. stop 3 GHz -- Span 300 MHz / div.
2 dB / div -- Ref. center level 15 dBENR

NS-301 out level 15 dBENR
including a 16 dB attenuator , best result and worst result over 4 different samples tested in our laboratory

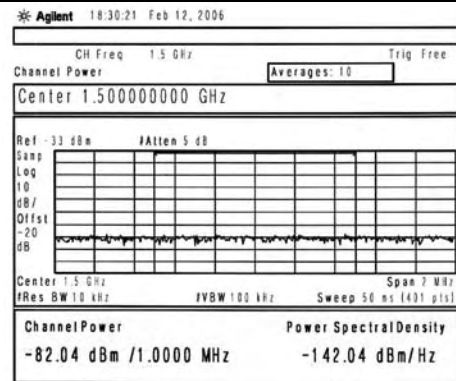

POWER SPECTRAL DENSITY

NS-301
measured at 1.5 GHz

Noise power
= -82 dBm
(BW 1 MHz)

equal to
Spectral density
= -142 dBm / Hz
(= 32 dBENR)

Diode application as NOISE SOURCE for noise figure measurements

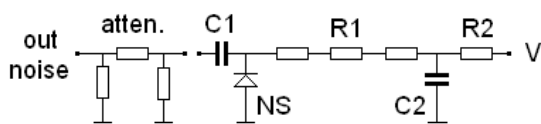

very simplified scheme of a noise generator, it is possible to improve the bias by inserting, for example, a 2931 or 2951 regulator in the bias network (instead of R2). The attenuator is necessary to reach a low return loss on the output port and to bring the noise level to the measurement standards (5 or 15 dBENR)

NS = noise source diode
 C1 = for the 4 GHz version it is not critical, from 1 to 10 nF
 C1 = for the 8 GHz version (especially if you want to reach 10 GHz) it has to be COG and of good quality, see the note above
 R1 = 3 x 11 Ω in series , a low R1 value (25 - 35 Ω) little decrease the output noise level but makes it flatter.
 R2 = 3K3Ω for NS 301 - 2K2Ω for NS 303, these values are for +28V pulsed power supply as available on most Noise Figure Meters. A higher bias value increase the frequency band. A lower bias value makes a flatter noise level .
 With a 16 dB attenuator it is obtained an output level of 15dBENR
 NOTES , values for V = 28 v - case 0805 or 0603

see the following pages regarding 2 articles on noise source diode with very interesting applications

Here follow 8 pages of an article focusing on noise source diodes with kind permission of VHF Communications editorial office

VHF COMMUNICATIONS 1/2007

Franco Rota, I2FHW

Noise source diodes

1. Noise

1.1 Introduction

All materials generate noise and the noise is proportional to its temperature starting from 0°K (-273°C). The noise depends on the chaotic movements of the electrons, the thermal noise is known as white noise (from optical physics) as it fills the whole spectrum.

From an electronics point of view the noise causes big limitations to our devices for example amplifiers, instruments, radars, receivers, electro-medical, etc... A very simple example is the sensitivity limitation of receivers caused by the noise.

Although I have said that noise causes problems and limitations, I want to explain how in some cases, if it is artificially generated, it can even improve our electronic devices (see dithering in Table 1) or help to do some tests, a calibrated noise source is a very important tool in our labs.

1.2 Output level

For noise source applications the output level cannot be indicated as for other signal generators. Signal generators, transmitters etc... have

the output level indication in mV, dBm, W etc.... If you have a 100 to 200MHz sweep signal generator we say that the output level is, for example -10dBm, the amplitude of -10dBm is swept from 100 to 200MHz but it is not simultaneously in the whole frequency range.

In the case of noise sources the amplitude is simultaneously on the entire frequency range, this means that the amplitude is defined in dBm/Hz power spectral density, or in ENR excess noise ratio. ENR means the ratio in decibel of the output noise between the ON and OFF state of the diode, in the OFF state the diode has only -174dBm/Hz which is the output level generated by a resistor at 290°K.

For example, if you have a power spectral density of -142dBm/Hz it means that $(174 - 142 = 32)$ the ENR is 32 dB. If the bandwidth is 10Hz the noise power is -132dBm/10Hz if the bandwidth is 10KHz the noise power is -102dBm/10KHz.

2. Noise generator diode

2.1 Diode selection

The first noise generators (in the 1940's) used noble gas such as Argon with 15.3dBENR,



Table 1: Some applications regarding the generation of noise, it can improve electronic devices or help to do some tests on them.

- **Dithering**

In an A/D converter for example digital receivers, the noise injected improves the quantisation error, the sensitivity will be improved (this method is also used in audio and video).

- **Spectrum Analyser Calibration**

With a calibrated noise source devices it is very easy to verify the amplitude calibration of a spectrum analyser, the real advantage is the RF generation simultaneously on all the band

- **Noise Figure Measurement**

Test instruments for noise figure measurement in low noise amplifiers, converters, receivers, mixers and front ends.

- **Gain-bandwidth measurements**

A flat noise source can be used as a "tracking generator" combined with a spectrum analyser to ease measurements of gain and bandwidth.

- **Encryption**

- **Audio And Ultrasonic Test**

- **Test On Receiver**

The noise is useful to measure the sensitivity in some complex receivers like radars, base stations, radiometers etc...

A noise source can substitute for a more complex RF generator, moreover it can generate noise in a broad band spectrum simultaneously.

- **NPR Distortion**

This is a complex intermodulation measurement very often made on multichannels FDM, MMDS, CATV, cellular base stations, etc..

Injecting noise and measuring the distortion with special notch filters is used to obtain the measurement.

- **Fading Simulator**

By modulating an RF signal with noise it is possible to simulate a signal affected by fading, this is very useful in mobile radio testing.

- **Radio Astronomy**

- **EMI Testing**

Neon with 18.5dBENR, Helium with 21dBENR and were born in order to test the first radar systems.

Another system to generate noise is to use hot and cold resistors, mainly used in research labs with very high precision.

Zener diodes can be used to generate noise but the output level is not constant, not predictable and used only for HF frequencies, even some bipolar transistors like BFR34 have been used in the past for amateur applications using the reverse biased base-emitter diode, the output level is definitely not constant.

For our applications the right selections are:

- NS-301 SMD sod323 case, up to 3.5GHz
- NS-303 ceramic gold plated case, up to 10GHz

Both types are silicon avalanche diodes that provide 30-35dBENR with a broadband spectrum starting from 10Hz. In this article I will focus on the 3.5GHz type and in a second article I will also describe the 10GHz type which is more complicated.

At the beginning I tested the glass case type but this case was not suitable because the maximum frequency can be around 1.5 - 2GHz, for the same price we can have 3.5GHz with a flatter output level.

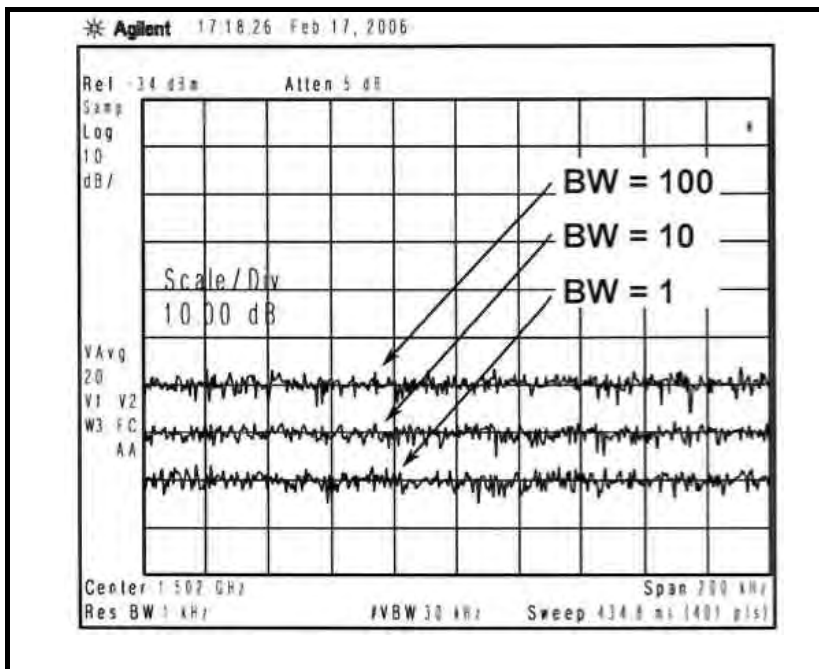

Fig 1: The same noise level related to 3 different bandwidths.

2.2 Schematic diagram

The SMD sod323 case has a very low series inductance typically 1 - 1.5nH which is reasonable for a 3GHz application. Fig 2 shows the SMD case sod323, the body is about 1.9mm long, it is useful for many applications in the lower microwave frequency range.

Fig 3 shows the circuit diagram of a NS-301 noise source diode up to 3.5 GHz.

C1 – dc blocking capacitor

The selection of this capacitor is extremely important to flatten the output level. I spent much time testing several

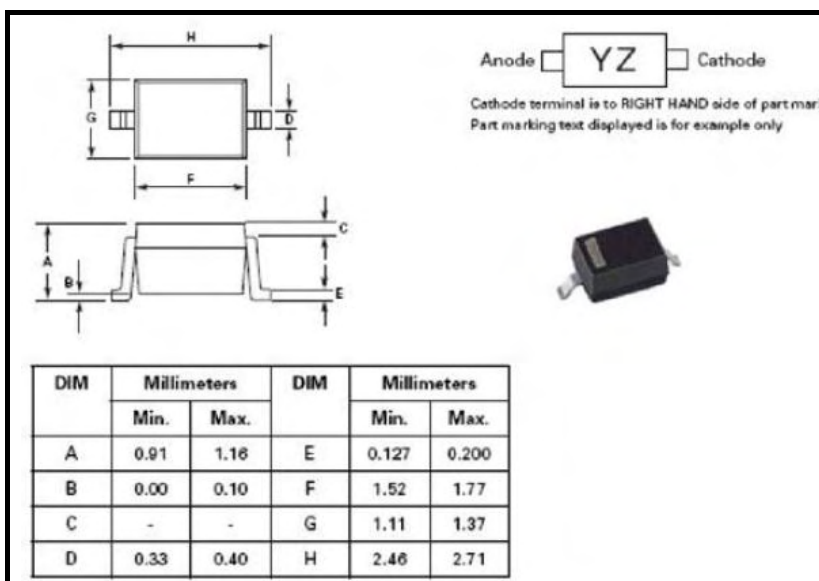

Fig 2 : The SMD SOD323 case.

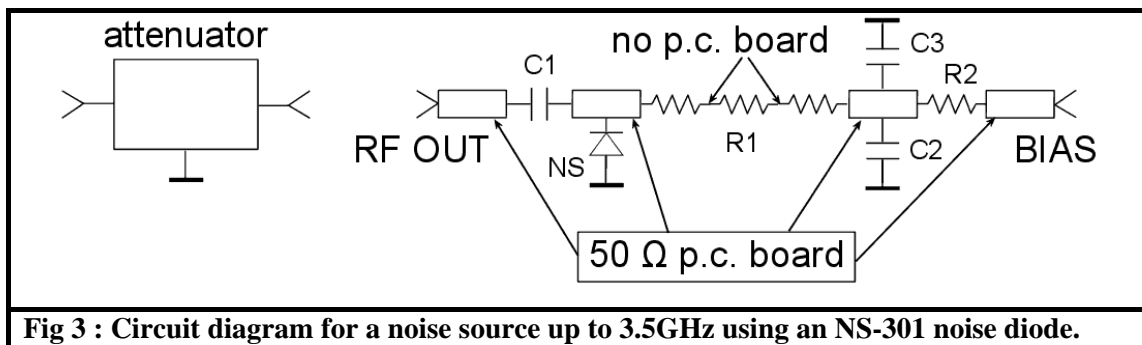

Fig 3 : Circuit diagram for a noise source up to 3.5GHz using an NS-301 noise diode.

types of capacitors, ATC porcelain capacitors have less insertion loss at microwave frequencies but they can't be used because their Q increase the self resonance dip.

For this purpose I selected a special capacitor case, 0805 COG, which can be used up to 12GHz (about 1.5nF), with this capacitor the minimum frequency is about 10MHz.

In the next article about the 10GHz noise source diode I will describe these capacitors in more details.

For 3GHz application the C1 capacitor isn't a crucial component, case 0805 or 0603 and values from 1nF to 10nF are good anyway.

C2, C3 – bypass capacitors

These capacitors are not critical; they can be 1nF and 10nF.

R1 - RF load resistors

This resistor is the sum of 3 resistors in series in order to keep the stray capacity as low as possible, the total value can be around 30 to 40Ω

The manufacturer of noise diodes says that the diode impedance is about 20 to 40Ω, I noticed that by assigning to R1 a lower resistance (20Ω), the output noise level is flatter, on the contrary with an increased resistance (40Ω) the output noise level is a little higher.

If possible, it is better to solder the resistors without using copper track on

the PCB.

R2 - bias resistor

For the noise diode NS-301 at about 5mA, +8/+12 V, the correct value is 3.3KΩ if you use the diode for noise figure measurements with a classic +28V pulse available from all the noise figure meters. If the diode is used as a general purpose noise generator to test a filter, for example with a spectrum analyser, you can connect directly to a +8/+12Vdc without the R2 resistor.

NS - Noise diode

As described above the NS-301 sod323 diode is a good selection for the 3GHz frequency range, it is important to remember to keep the pins as short as possible! The diode must be mounted very close to the output connector.

P.C. board

The FR4 fibreglass p.c. board is ok, the insertion loss is so little that it isn't worth a teflon laminate, vice versa it is very important the noise diode ground connection that has to be as short as possible (see the above explanation).

I tested several noise source diodes in my lab with sod323 case, Fig 4 shows the best and the worst result, in the frequency range 10MHz to 3GHz with 2dB/step and 300MHz/step, the centre reference level is 15dBENR and the noise source diode is connected with a 16dB pad attenuator.

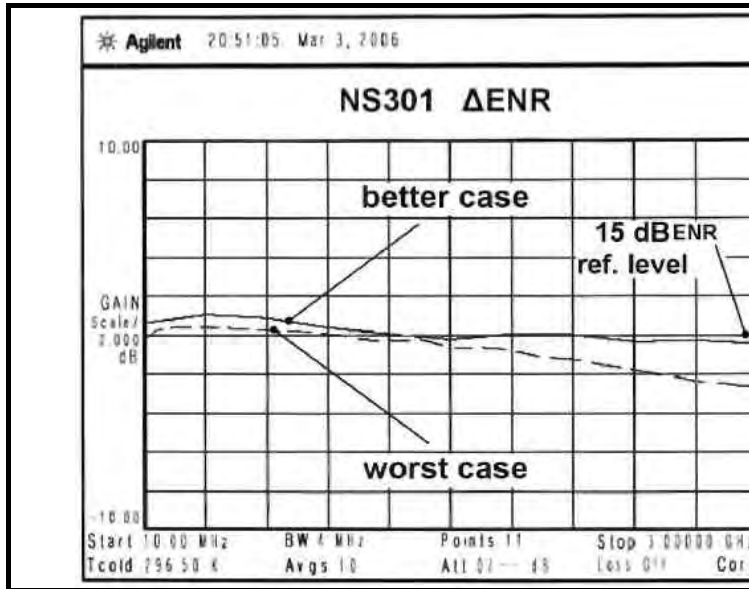

Fig 4 : The best and the worst test results on different noise source diodes.

2.3 Output attenuator

The purpose of this attenuator is two fold, the first one is to obtain the

15dBENR which is the right noise level accepted by a lot on noise figure meters. The output noise of the NS-301 diode is about 30-35dBENR this means that with a 16dB attenuator you can have about 15dBENR. Any other attenuation values can be used to get other ENR values.

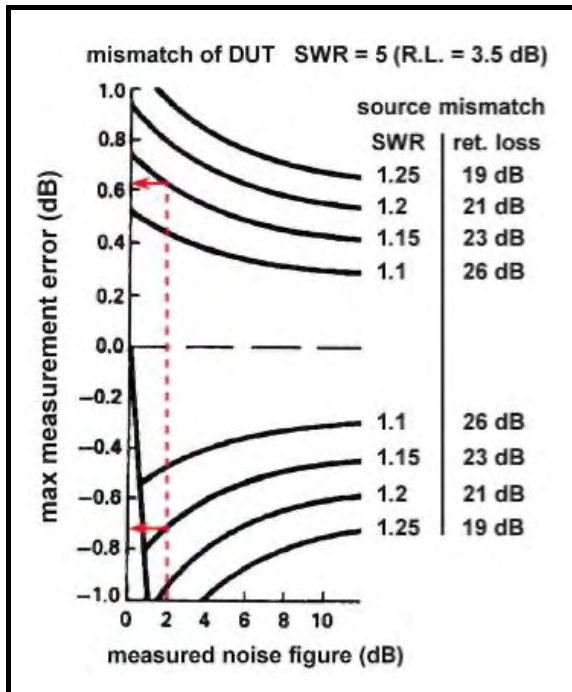

Fig 5 : A simple explanation of the mismatch due to the noise figure measurement.

The second and most important purpose of this attenuator is to match the output impedance to 50Ω. In noise source devices used for noise figure measurement, one of the most important condition is to match the output impedance as near as possible the 50Ω resistive load, the easiest way is to insert an attenuator to the output connector.

Normally the ultra low noise GaAsFet preamplifiers have a very bad input return loss, typically a VSWR from 20 to 2 (return loss from 1 to 9.5dB), so if we test this kind of preamplifier with a noise source with an high return loss the total error is unacceptable.

Fig 5 shows a simple explanation of the mismatch due to the noise figure measurement, we can assume that the preamplifier input return loss is 3.5dB, SWR = 5 (it can seem too high but it is a realistic value).

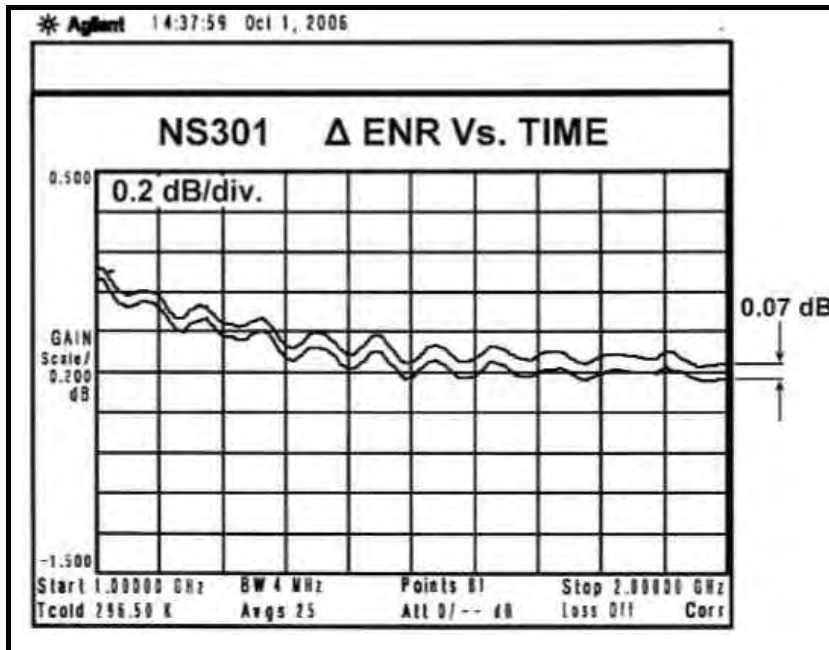

Fig 6 : Instability of noise source diode output.

If our noise figure meter measures 2dBNF and we assume also that the noise source output return loss is 23dB (SWR 1.15), the true noise figure can be between +0.63dB/ - 0.7dB for a 2dB measured value.

In conclusion we should keep the SWR of a noise source as low as possible in

order to do more accurate noise figure measurements.

Fig 6 shows the instability that it is quite good for amateur applications, for 8 hours of continuous operation it is only 0.07dB of output level but there is also a 0.03dB of testing instrument instability to consider.

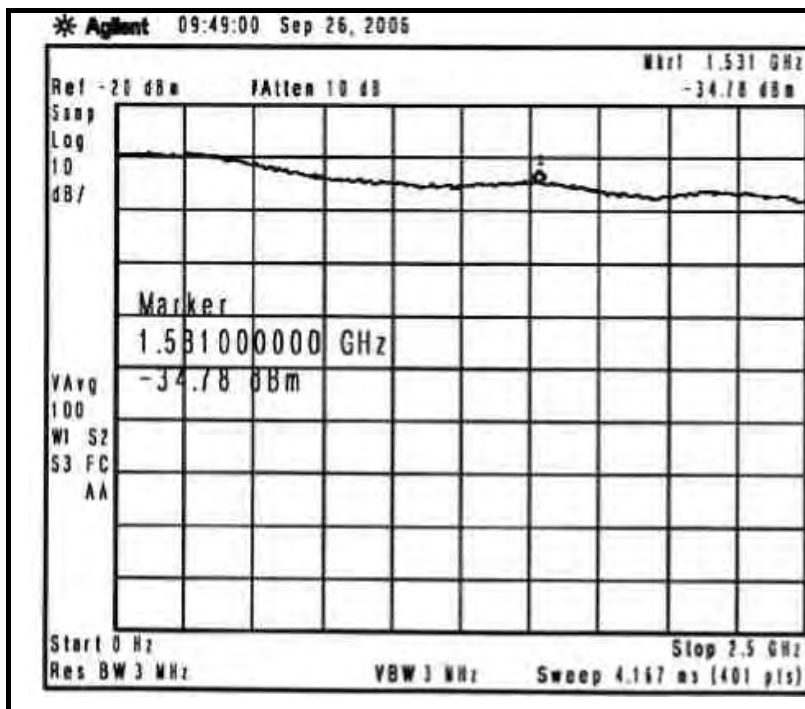

Fig 7 : Response with a 45dB amplifier.

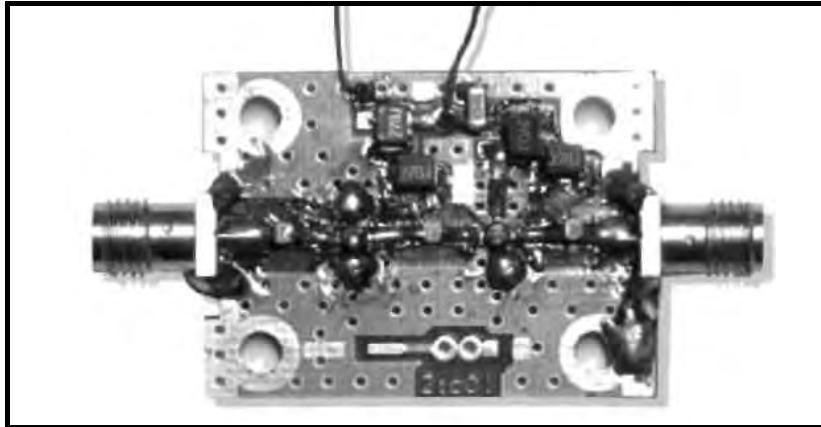

Fig 8 : Picture of the broadband amplifier.

3.

General purpose noise generator

As shown in Table 1 a diode noise source can be used successfully in a broadband noise generator combined with a spectrum analyser like a “tracking generator”. This is not a true tracking generator because it works in a different way. As I said above the tracking generator is like a sweep generator so its frequency moves from start to end but it is not simultaneous in all the frequency range.

If we combine a broadband noise generator with a spectrum analyser we

can do a measurement of band pass filters, return loss etc. The signal coming from the noise generator diode is very low so we need at least 45dB of amplification, however 65dB is better. The real difficulty is to obtain a reasonable flat amplifier response. For this purpose I made an amplifier using INA03184 and INA10386 MMICs, the result is shown in Fig 7 and the total response is given by the noise source diode combined with the 45dB amplifier.

Figs 8 and 9 show the 45dB broadband amplifier from few MHz to 2.5GHz used as noise amplifier in order to test the 2GHz band pass filter. This circuit is not difficult to build and it can be used in any lab as general purpose broadband amplifier.

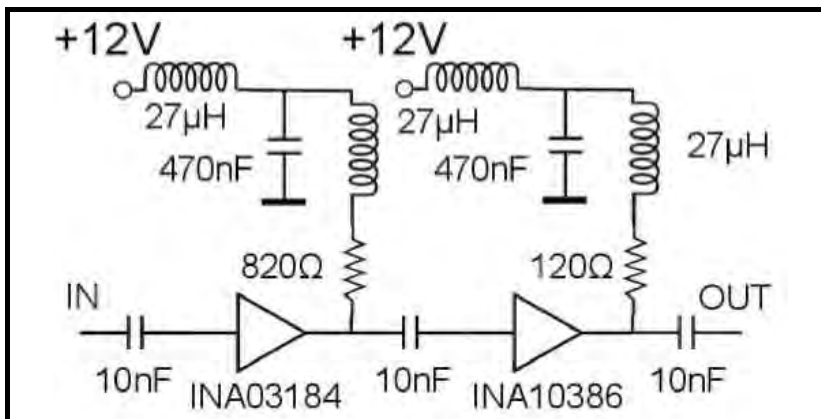

Fig 9 : Circuit diagram of the broadband amplifier.

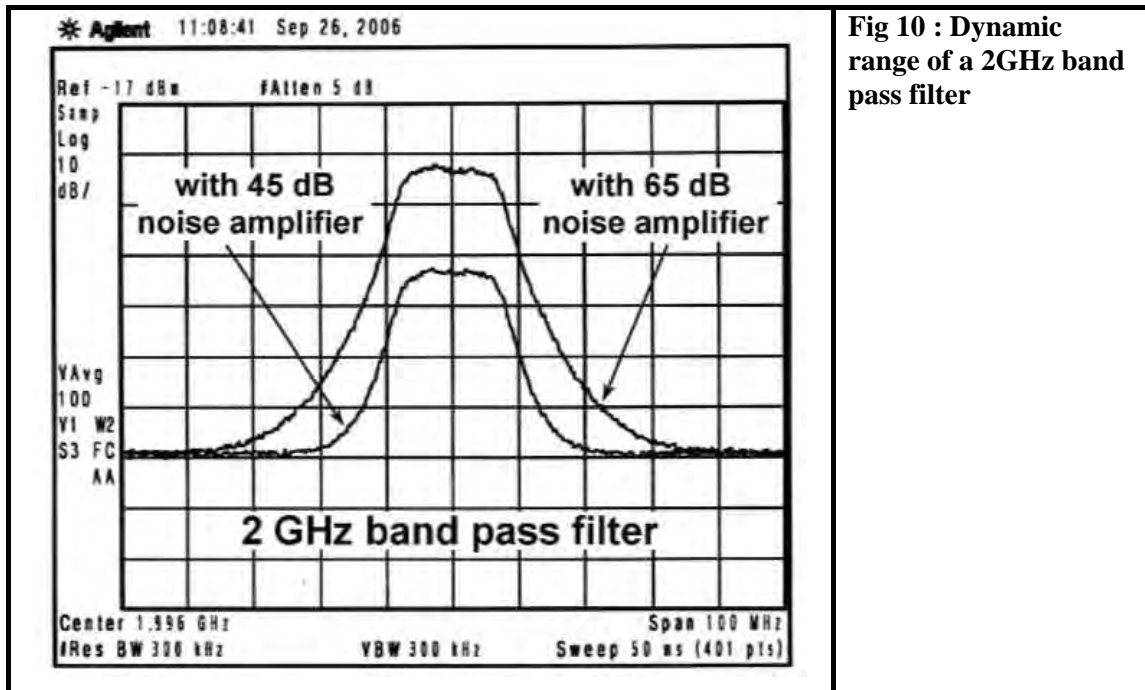

Fig 10 : Dynamic range of a 2GHz band pass filter

Fig 10 shows the dynamic range of a typical 2GHz band pass filter with a noise amplification of 45 dB and 65dB. The dynamic range improves with more amplification, but it is more difficult to achieve a flat output level.

Fig 11 shows the equipment setup used for the filter measurement.

It is demonstrated that with a simple noise generator and a good amplifier it is possible to build an instrument very close to a tracking generator to use with any kind of spectrum analyser. It means that we can “upgrade” an old spectrum

analyser, typically the HP 141 series or any other type, with an option that works like a tracking generator.

NS301 noise source specifications are:

- Frequency range: 10Hz - 3.5GHz
- Output level : 30/35dBENR (-144/-139dBm/Hz)
- Bias: +8/+12V, 5mA

It is available from R F Elettronica - www.rfmicrowave.it

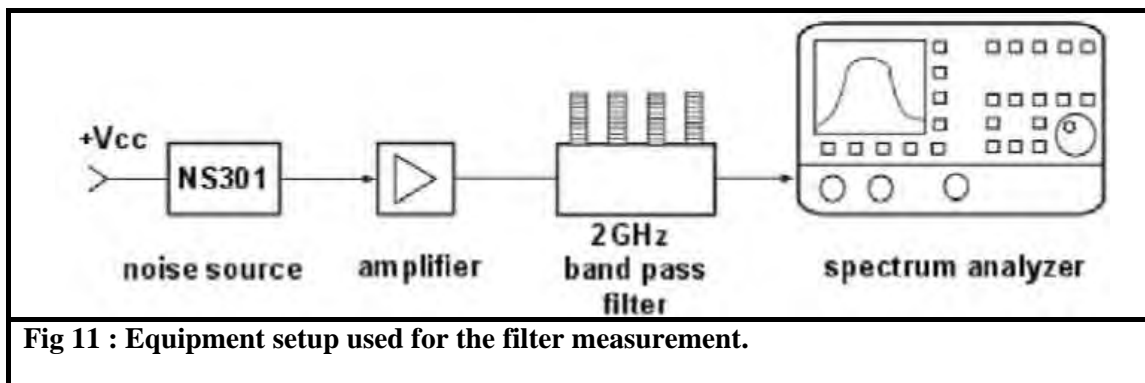

Fig 11 : Equipment setup used for the filter measurement.

1 - Introduction

In VHF Communications 1/2007⁽¹⁾ I described a simple 10MHz to 3.5GHz noise source, the purpose of that article was to explain how to build a very simple noise generator using the NS-301 noise diode, either for applications like noise figure measurement or for a broadband noise generator for scalar applications with a spectrum analyser.

Now I will describe a 10MHz - 10GHz noise source generator with an improved bias network that uses the NS-303 noise diode.

This project was born some months ago for the 13th E.M.E. (moon bounce) conference in Florence during August 2008, the organisation asked me to cooperate to build some noise source generators to give to participants during the conference.

Tests and measurements are supported by 20 pieces of noise source generators built for this conference, so I think that results are very reliable and repeatable.

2 - Schematic diagram and components

The noise generator uses the NS-303 diode that is guaranteed up to 8GHz but following the descriptions below it will be very easy to reach 10.5GHz making possible to use it up to the 3cm band (10.368 GHz), using a diode of moderate price.

The aim of this article is to explain how to build a noise generator using easy to find components.

<p>Diode NS-303 specifications Frequency range: 10Hz - 8GHz (max. 10GHz) Output level: about 30dBENR Bias: 8 - 10mA (8 - 12V)</p>	<p>Case: Metal-ceramic gold plated Cathode </p>
---	--

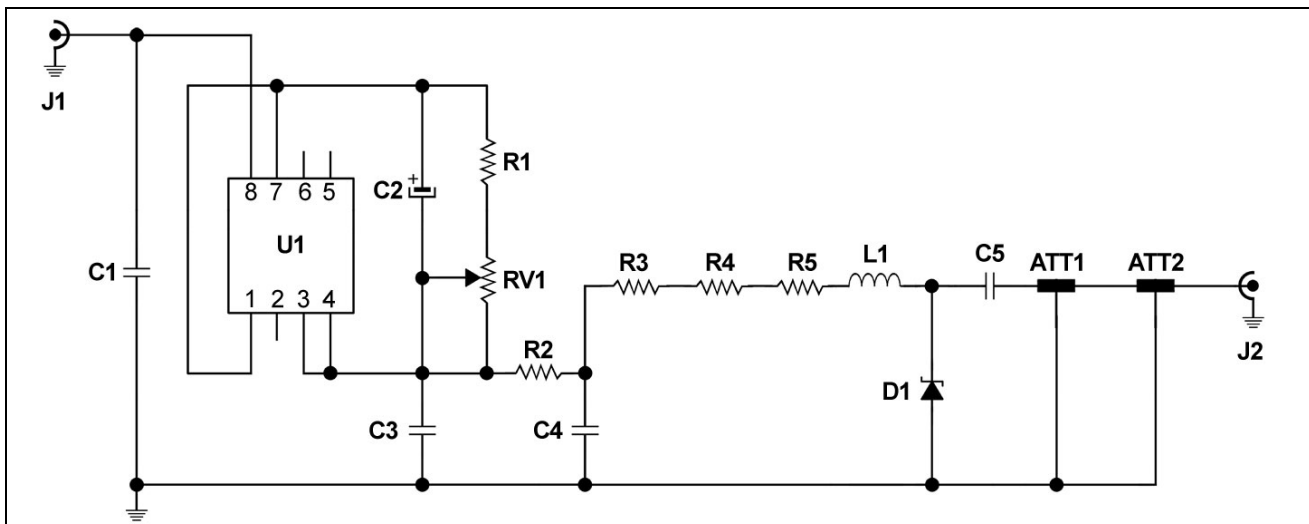

Fig. 1
 Circuit diagram for a noise source 10MHz - 10GHz using a NS-303 noise diode

Part list		
D1	NS-303 noise diode	NS-303
U1	LP2951CMX in case SMD SO8	LP2951CMX
C1	10 nF 0805	
C2	1 μ F 25 V Tantalum	
C3	100 nF 0805	
C4	1 nF 0805 COG	CCB-1n
C5	2 x 1 nF 0805 COG in parallel, see description	CCB-1n
ATT1	6 dB chip attenuator dc-12 GHz	
ATT2	7 or 8 dB external attenuator dc-12 GHz or better dc-18 GHz	
J1	BNC female connector	
J2	SMA male panel mount connector Suhner 13SMA50-0-172	SMA-24A
R1	100 Ω 1206	
R2	18 Ω 0805	
R3, R4, R5	33 to 68 Ω each 0603	
L1	6.8 or 8.2 nH 0603	BCQ-6n8-A
RV1	100 Ω trimmer multi turn SMD	POT-SM-101-M
PC BOARD	25N or RO4003 or RO4350 or equivalents, 30 mils, ϵ_r 3.40 size 11x51 mm, see description	25N-30

The circuit diagram, Fig 1, is very simple, the power supply is 28V pulsed AC applied to connector J1 which is normalised in all the noise figure meter instruments. U1 is a low dropout precision regulator to stabilise the voltage for the noise diode to 8 - 12V, the current through the diode can be around 8 to 10mA set by trimmer RV1.

2.1 - R3, R4 and R5 resistors

These resistors can be a total of 100 - 220 Ω , the total value is not critical, the 0603 case is very important in order to keep the stray capacitance as low as possible, it would be better to solder the resistors without using copper track on the PCB see Fig 4.

2.2 - ATT1, ATT2 Attenuators

These attenuators are very important to obtain an output level of about 15dBENR but more important to obtain an output return loss as low as possible.

In my previous article in issue 1/2007 I described this concept very well, the mismatch uncertainty is the main cause of errors in noise figure measurement⁽²⁾.

The total value of attenuators ATT1 + ATT2 can be around 14dB, the pictures Fig 4 – 5 show a 6dB chip attenuator mounted on the PCB and a 7 or 8dB external good quality attenuator, in fact the output return loss depends mainly on the last attenuator (ATT2). The first attenuator (ATT1) can be less expensive and built directly on the PCB because it is less important for the output return loss.

I used a 7 or 8dB external attenuator in order to obtain the best output ENR value because every diode has it's own output noise.

Everyone can change the output attenuator depending on the ENR that is needed; in this project I chose an output level of 15dBENR so the attenuators have a value of 14dB.

2.3 - C5 dc block output capacitor

The selection of this capacitor is very important to flatten the output level; in the previous article I only quickly mentioned this fact because we were only talking about 3.5GHz, now in order to reach 10.5GHz I will do a better description.

The dc block capacitors are used to block the dc voltage and to pass the RF signal with the minimum possible attenuation. If you use the ATC100A or 100B capacitors they have a very low insertion loss but have the problem of self resonance in ultra wide band applications, the graphs below show 2 examples where you can improve the SRF with vertical orientation.

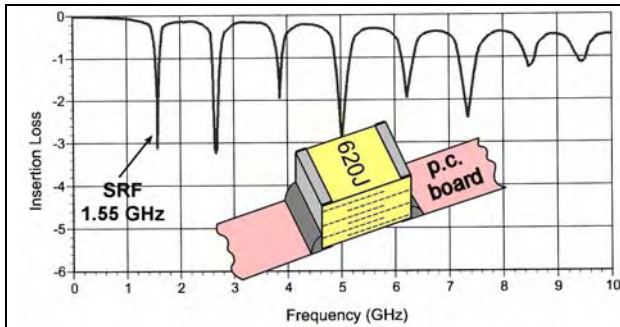

ATC100B 62 pF

□ 110mils = 3mm

The manufacturer guarantees a SRF > 900MHz, in fact the network analyser shows a SRF of 1.55GHz (with parallel orientation)

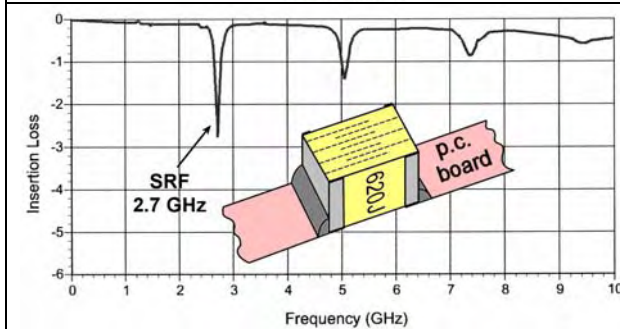

ATC100B 62 pF

□ 110mils = 3mm

With the same capacitor the network analyser shows a SRF 2.7GHz (with vertical orientation)

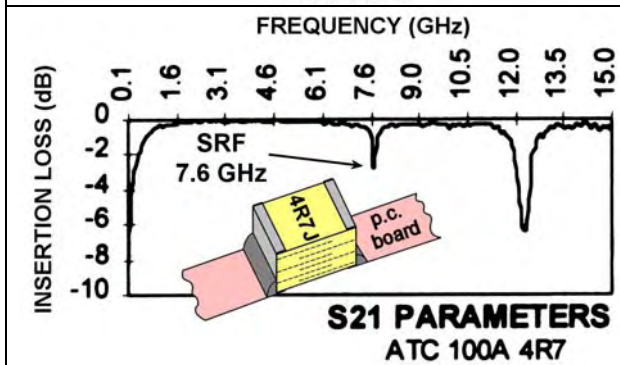

ATC100A 4.7 pF

□ 55mils = 1.5mm

The manufacturer guarantees a SRF > 4GHz, in fact the network analyser shows a SRF of 7.6GHz (with parallel orientation)

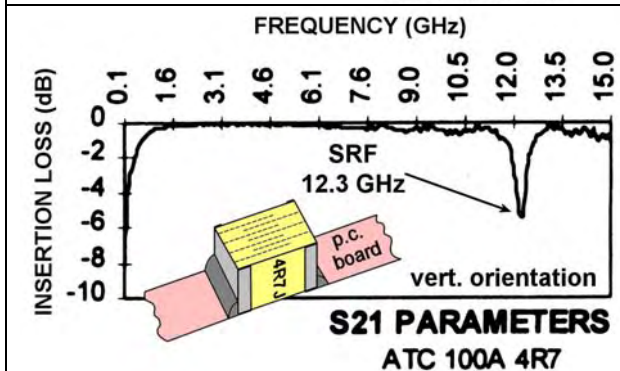

ATC100A 4.7 pF

□ 55mils = 1.5mm

With the same capacitor the network analyser shows a SRF 12.3GHz (with vertical orientation)

Fig. 2
Examples of SRF frequency and its improvement

Fig 2 shows 4 graphs of the SRF frequencies for ceramic capacitors and how to improve the SRF of ATC100A or 100B capacitors for ultra wide band applications.

My decision was to avoid ATC capacitors and to find some capacitors without any SRF and lower Q, after many attempts and researches I found that NP0 class 1 multi-layer capacitors

with an 0805 case that have the best performances referred to low level applications (not to be used in RF power applications or in low noise amplifiers).

I choose to put 2 1000pF capacitors in parallel in order to reach a minimum frequency of 10MHz.

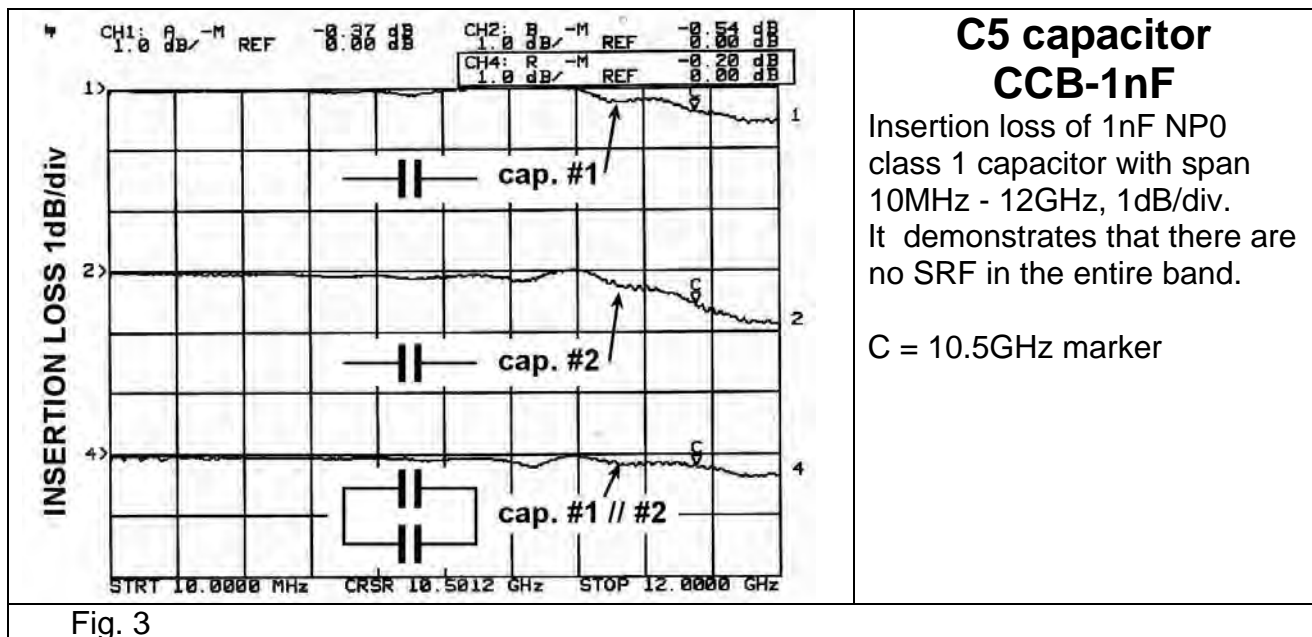

Fig. 3

For ultra broad band applications the ATC manufacturer has a capacitors of 100nF with 16KHz to 40GHz frequency operation in a 0402 case⁽³⁾ but I prefer to avoid this special component and use more easy to find one.

In Fig 3 the 1nF capacitors show a low insertion loss, with 2 capacitors in parallel, the marker C shows an insertion loss of about 0.2dB at 10.5GHz that is appropriate for this project at low price.

2.4 - P.C. board

The noise generator is considered a passive circuit so it is not necessary to use very expensive Teflon laminates, moreover the track length is so short that the attenuation introduced makes it unnecessary to use Teflon laminates. I selected ceramic laminate, that is very popular in RF applications, with ϵ_r 3.40. It is available in several brands and they all have the same performance, Rogers RO4003 or RO4350, Arlon 25N etc..., with a thickness of 30mils (0.76mm).

In order to easily reach the 10GHz band it is necessary to remove the ground plane around R3, R4, R5 and L1, the size is 7 x 4mm

2.5 - Metallic box

As shown in Fig 5 the components of the noise source generator are enclosed in a very small milled box. Every box behaves like a cavity excited by several secondary propagation modes. For higher frequencies or in medium size boxes the RF circuit will also have many secondary propagation modes at various frequencies. Since every box is different in size, shape and operating frequency the calculation of secondary propagation modes is very difficult. To avoid this problem microwave absorbers are very often used placed into the cover of the box to damper the resonance⁽⁴⁾.

I selected a very small box in order to avoid both the secondary propagation modes and the microwave absorber; the size that I used gives no troubles up to 10GHz.

If someone wants to increase the size of the box (internal size) it will be necessary to use a microwave absorber.

It is also necessary to remove part of the ground plane in the metallic box by milling a 7 x 4 x 3mm deep slot corresponding to R3, R4, R5 and L1.

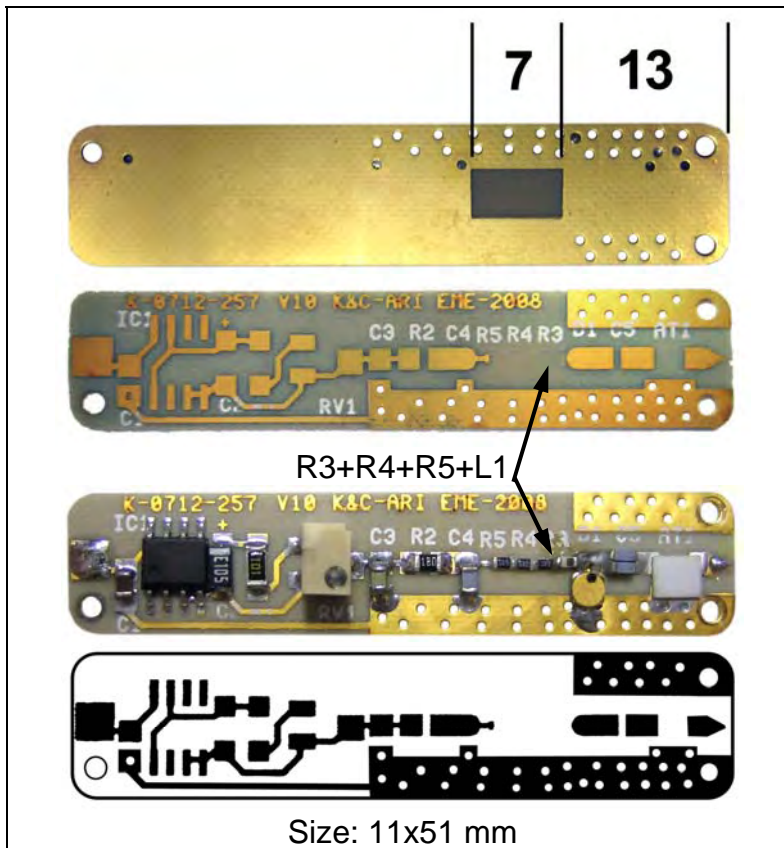

Fig. 4
P.C. board and mounting components

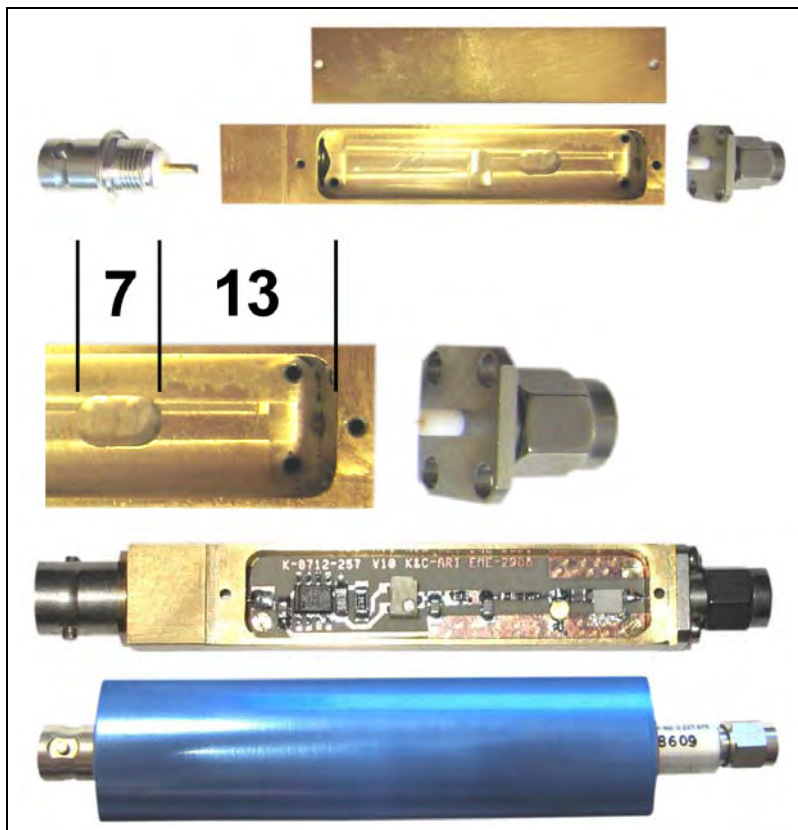

Fig. 5
Box and final release

3 - Bias current

The nominal current should be 8mA, during my tests I found that the output noise level has a quite strange but interesting variation: increasing the diode current the output noise level decrease of about 0.5dB/mA up to about 9GHz, beyond this frequency the effect is exactly the opposite.

Fig 6 shows the difference in output ENR of about 1dB with 8 and 10mA bias current and Fig 7 shows a little improvement of frequency range by about 500MHz with 8 and 10mA bias current.

Fig 7 shows the decrease of about 1dB of ENR level with 10mA instead of 8mA maintaining the same shape in the diagram.

During the calibration it is possible to play with the current to "tune" the ENR level, if you can loose 1dB of ENR level, you will have a more extended frequency range which is exactly what is needed to reach the 3cm amateur radio frequency band (10.4GHz).

The bias current can be measured easily directly on the BNC input connector with +28Vdc from a normal power supply; the input current is more or less the same current through the noise diode.

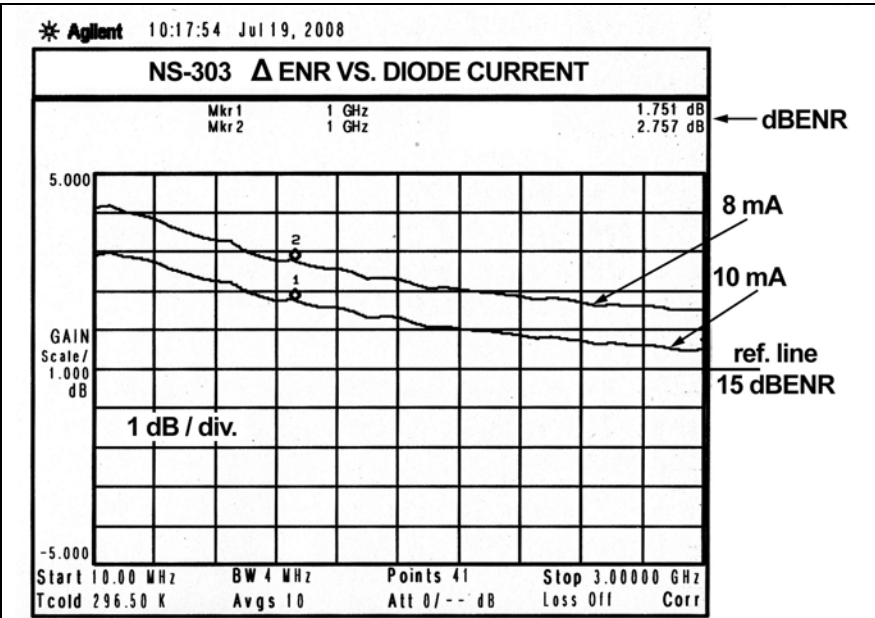

Fig. 6
It shows the variation of output noise level vs. current
Span 10MHz - 3GHz
1dB/div.

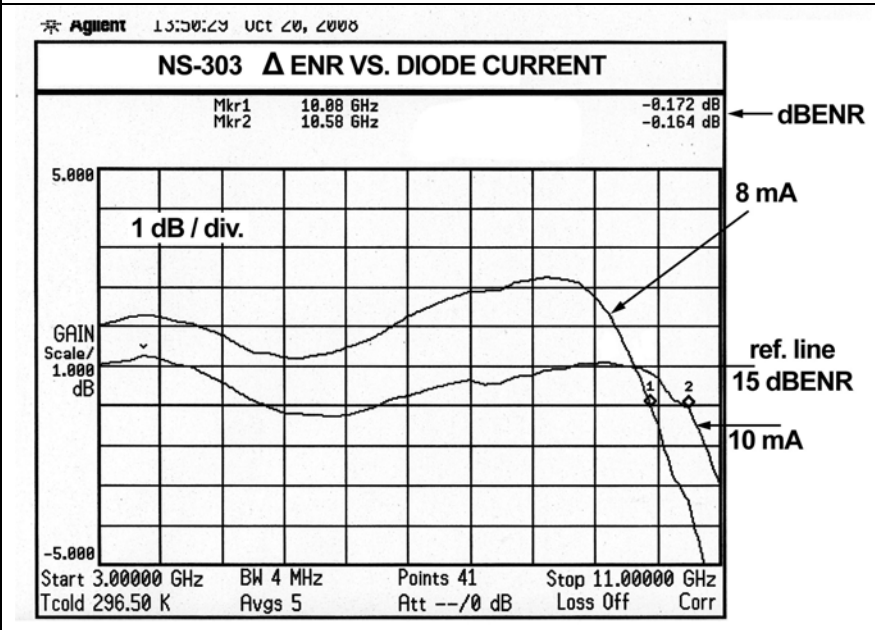

Fig. 7
It shows the variation of output noise level vs. current
Span 3GHz - 11GHz
1dB/div.

4 - Test results

I tested 20 pieces of the noise sources generator and they all gave nearly the same results, the measurement below, Fig 8, refer to the use of a 6dB internal attenuator plus a 8dB external attenuator (MaCom or Narda dc-18 GHz).

A typical output noise level can be 15dBENR +/-1.5dB or 15dBENR +/-2dB or 15dBENR +/-2dB, a ripple of +/-1.5dB or +/-2dB is a normal values.

The output return loss depends mainly on the external attenuator; I measured a 30dB return loss up to 5GHz, 28dB up to 8GHz and 25 to 28dB at 10GHz.

We have to consider that each 1dB more of external attenuation will improve the output return loss by 2dB, so if you can use, for instance, an attenuator of 17/18dB you will reach a very good return loss (>30/35dB) with an output noise around 5dBENR.

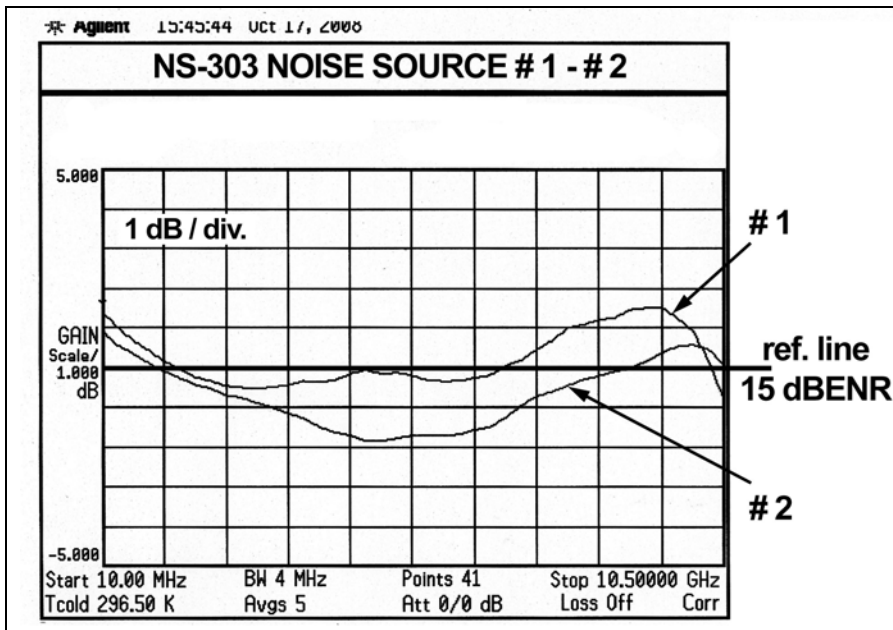

Fig. 8

Typical output noise from 2 different noise sources.
Span 10MHz - 10.5GHz
Reference line 15dBENR
1dB/div.

5 - Calibration

Unfortunately the calibration of a noise source is not an easy thing to do.

We know very well that RF signal generators have an output level precision of typically +/-1/1.5dB and this doesn't worry us, we also know that our power meter can reach +/-0.5dB precision or even better. We need a very high precision for a noise generator used with a noise figure meter. For the classic noise source 346A, B and C, Agilent gives ENR uncertainty of +/- 0.2dB max. (< 0.01dB/°C). The new N4000 series are used for the new noise figure analyser N8975A with ENR uncertainty of +/-0.15 dB max.

In my lab I used the new noise figure analyser N8975A with the precision noise source N4001A so I can guarantee a typical precision of +/- 0.1dB up to 3GHz and 0.15dB up to 10GHz.

It means that the calibration must be done with a good reference noise source, it can be a calibrated noise source compared with the one you have built with a low noise preamplifier and a typical noise figure meter.

Example: you have a low noise amplifier with 0.6dBNF and your calibrated noise source indicates a 15.35dB of ENR, now you can change the noise source to the one you have built and for instance you measure 0.75dBNF, it means that your noise source has 15.35 + (0.75dB - 0.6dB) = 15.50dBENR.

6 - Other application

As I described in the previous article⁽¹⁾ that the noise source can be used as a broadband noise generator combined with a spectrum analyser like a “tracking generator” for scalar applications.

This is not a true tracking generator because it works in a different way (read my previous article⁽¹⁾). The problem here is to reach 3 decades of frequency range, 10MHz to 10GHz, with a flat amplifier of at least 50dB.

Today some MMICs are available that can do this work like ERA1, ERA2, MGA86576 etc..., the problems can be to reach a flat amplification and to avoid self oscillations with such high amplification.

This device can be very interesting because it can be a useful tool to use with any kind of obsolete spectrum analyser to tune filters, to measure the return loss etc... up to 10GHz.

For anymore informations regarding noise source diodes see
www.rfmicrowave.it/pdf/diodi.pdf (from page A 14)

Notes:

- (1) VHF Communications 1/2007 “Noise source diodes”
- (2) For those who need more information about the mismatch uncertainty in noise figure measurement I suggest 3 application notes:
 - Ham Radio, August 1978
 - Noise figure measurement accuracy AN57-2 Agilent
 - Calculating mismatch uncertainty, Microwave Journal May 2008
- (3) R.F. Elettronica web site catalogue www.rfmicrowave.it (capacitors section)
- (4) VHF Communications 4/2004 “Franco’s finest microwave absorber”

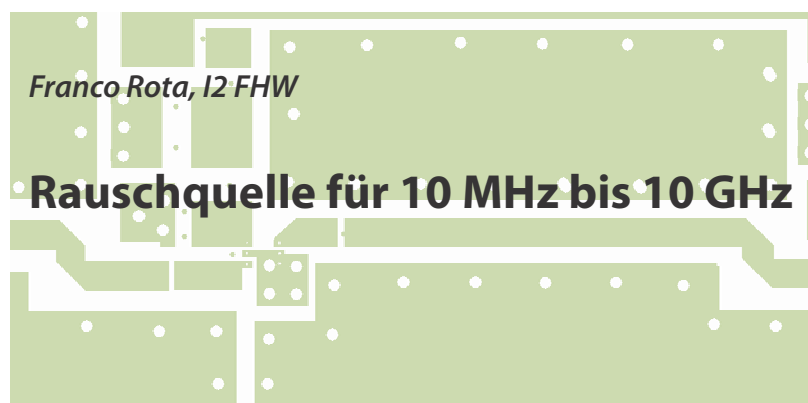

1. Einführung

Die Idee zu diesem Projekt wurde vor einigen Monaten im Vorfeld der 13. E.M.E.-Konferenz in Florenz im August 2008 geboren. Von den Organisatoren wurde ich gebeten, Rauschgeneratoren für diese Konferenz zu bauen. Die erfolgreiche Entwicklung führte zum Bau einer Reihe von Geräten. Die Tests und Messungen wurden an insgesamt 20 Geräten durchgeführt. Somit sollten die Ergebnisse verlässlich und wiederholbar sein.

Nachfolgend wird also ein Rauschgenerator für den Bereich von 10 MHz bis zu 10 GHz beschrieben. Realisiert mit einer Rauschdiode vom Typ NS-303 mit einer verbesserten BIAS-Schaltung.

2. Die Schaltung

Das Herzstück dieses Rauschgenerators ist die Diode vom Typ NS-303 (**Bild 1**),

deren Daten bis 8 GHz spezifiziert sind. Folgt man jedoch der nachfolgenden Beschreibung, können mit Leichtigkeit 10,5 GHz erreicht werden, was bedeutet, dass der Generator auch noch im 3-cm-Band eingesetzt werden kann, und das mit einer bezahlbaren Diode.

Ziel dieses Artikels ist es unter anderem einen Weg aufzuzeigen, wie man einen Rauschgenerator mit Standardbauteil-



Bild 1: Rauschdiode Typ NS-303 im vergoldeten Metall-Keramik-Gehäuse;
 Frequenzbereich: 10 Hz - 8 GHz
 (max. 10 GHz)
 Ausgangspegel: ca. 30 dBENR,
 BIAS: 8 - 10 mA (8 - 12 V)

Franco Rota, I2 FHW, Rauschquelle ...



Bild 2: Das Schaltbild einer Rauschquelle mit der Rauschdiode NS-303 für den Bereich 10 MHz bis 10 GHz

len realisieren kann. Das sehr einfache Schaltbild ist in **Bild 2** dargestellt. Die Bauteileliste folgt in Tabelle 1.

Die Versorgung erfolgt über 28 V gepulste Wechselfspannung, die an den Anschluss J1 gelegt wird; das ist ein Standard für alle Rauschzahlmessgeräte. Mit dem Präzisions-Spannungsregler U1 wird die Spannung für die Rauschdiode auf 8 bis 12 V stabilisiert. Der Strom durch die Diode kann zwischen 8 und 10 mA betragen und wird mit dem Trimmer RV1 eingestellt.

2.1. Die Widerstände R3 - R5

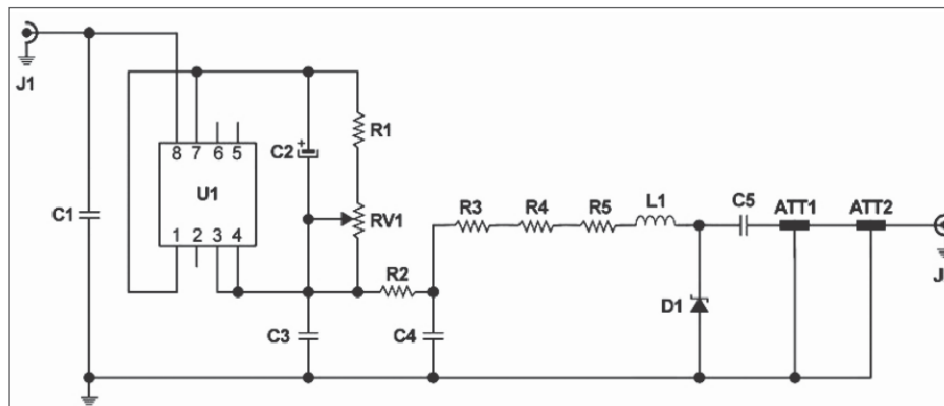
Diese Widerstände haben einen Gesamtwert von 100 bis 220 Ω , wobei der Absolutwert nicht kritisch ist. Sehr wichtig dagegen ist die Gehäusegröße 0603, damit die Streukapazität so gering

Tabelle 1: Bauteilliste:

D1	NS-303, Rauschdiode
U1	LP2951CMX, SMD, SO8-Gehäuse
C1	10 nF, 0805
C2	1 μ F, 25 V, Tantal
C3	100 nF, 0805
C4	1 nF, 0805, COG
C5	2 x 1 nF, 0805, COG parallel
ATT1	6 dB Chip-Dämpf. bis 12 GHz
ATT2	7 / 8 dB ext. Dämpfungsglied, DC-12 GHz oder DC-18 GHz!
J1	BNC-Buchse
J2	SMA-Flansch-Stecker
R1	100 Ω , 1206
R2	18 Ω , 0805
R3-5	33 Ω bis 68 Ω , 0603
L1	6,8 nH oder 8,2 nH, 0603
RV1	100 Ω SMD-Trimmer, Mehrgang, (POT-SM-101-M)
PCB	25N oder RO4003 oder RO4350; 30 mils; ϵ_r 3,40; 11 x 51 mm



Bild 3a.)
ATC100B mit 62 pF 100 mils = 3 mm

Der Hersteller garantiert Eigenresonanzen erst oberhalb 900 MHz; tatsächlich findet man die erste bei 1,55 GHz bei „liegender“ Montage

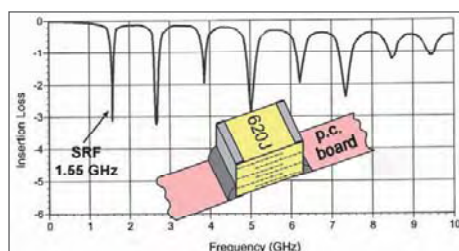

Bild 3b.)
ATC100B mit 62 pF 100 mils = 3 mm

Der selbe Kondensator hat bei „gekippeter“ Montage seine 1. Eigenresonanz bei 2,7 GHz

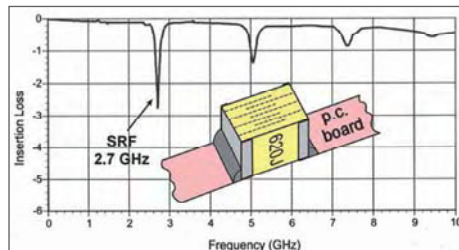

Bild 3c.)
ATC100A mit 4,7 pF 55 mils = 1,5 mm

Der Hersteller garantiert Eigenresonanzen erst oberhalb von 4 GHz; tatsächlich findet man die erste bei 7,6 GHz bei „liegender“ Montage

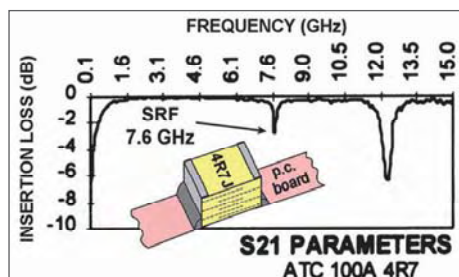

Bild 3d.)
ATC100A mit 4,7 pF 55 mils = 1,5 mm

Der selbe Kondensator hat bei „gekippeter“ Montage seine 1. Eigenresonanz erst ein 12,3 GHz

Bilder 3a-d: Eigenresonanzen von Kondensatoren in Abhängigkeit ihrer Einbaulage

wie möglich gehalten wird. Ebenso ist es sinnvoll die Widerstände auf der Leiter-

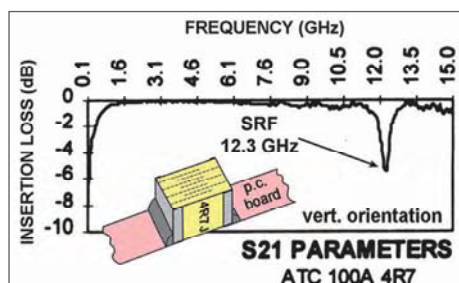
platte ohne Kupferbahn direkt aneinander zu löten (Bild 5).

Franco Rota, I2 FHW, Rauschquelle ...



Bild 4:
Der Kondensator C5 als 1 nF-Version. Zu sehen ist die Einfügedämpfung des 1 nF, NPO, Klasse 1-Kondensators, dargestellt im Bereich 10 MHz bis 12 GHz bei 1 dB/Div. Man sieht, dass über den gesamten Bereich keine Eigenresonanzen zu finden sind; der Marker C = 10,5 GHz

2.2. Die Abschwächer

Diese Dämpfungsglieder sind hier sehr wichtig um einen Ausgangspegel von etwa 15 dB_{ENR} zu erhalten. Viel wichtiger ist noch eine Rückflussdämpfung am Ausgang, die so niedrig wie möglich ist. In [1] wurde bereits beschrieben, dass der Hauptgrund für Fehler bei Rauschzahlmessungen die Unsicherheit der Fehlanpassung ist. Der Gesamtwert der beiden Abschwächer ATT1 + ATT2 kann bei etwa 14 dB liegen.

Die **Bilder 5** und **6** zeigen ein 6 dB-Chip-Dämpfungsglied, das auf eine Leiterplatte montiert wurde und ein externes 7 - 8 dB Dämpfungsglied von guter Qualität.

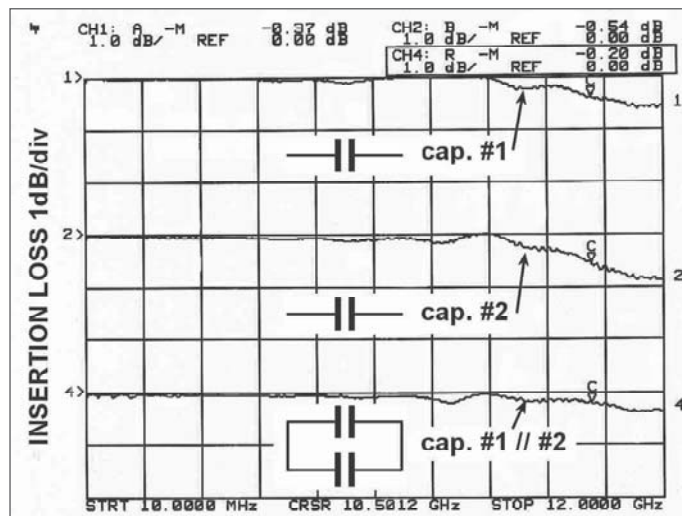
Es zeigt sich, dass die Ausgangs-Rückflussdämpfung hauptsächlich vom letzten Abschwächer (ATT2) bestimmt wird. Der erste Abschwächer (ATT1) kann

durchaus preiswerter sein und direkt auf die Leiterplatte gelötet werden, da er für eine gute Ausgangsanpassung weniger entscheidend ist.

Hier wurde ein externes Dämpfungsglied mit 7 bzw. 8 dB eingesetzt um den besten Ausgangs-ENR-Wert zu erhalten, da jede Diode ihr eigenes Ausgangsrauschen hat.

Natürlich kann jeder individuell den Wert des Ausgangsdämpfungsglieds wählen, je nach benötigtem ENR. Hier wurde ein Ausgangspegel von 15 dB_{ENR} gewählt, was auf Abschwächerwerte von 14 dB herausläuft.

2.3. Der Ausgangskondensator

Der Wahl des Ausgangskondensators C5 ist hier sehr viel Aufmerksamkeit

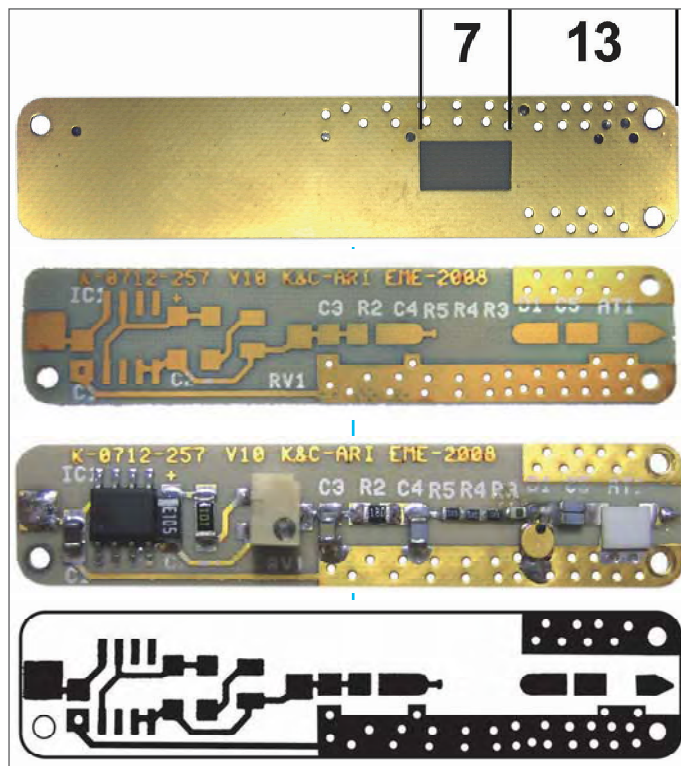

*Bilder 5:
Massefläche
mit Aussparung;
Layout der SMD-
Bestückungsseite;
bestückte Leiterplatte
und Layout der
kleinen Leiterplatte
für die Rauschquelle*

zu schenken! Hat er doch gewaltigen Einfluss auf die Ebenheit des Ausgangspiegels, zumal das Ausgangssignal ja hinauf bis 10,5 GHz reichen soll.

Der Ausgangskondensator soll die Gleichspannung auf dem Ausgangssignal abblocken und lediglich das HF-Signal mit geringstmöglichen Verlusten durchlassen.

Verwendet man beispielsweise SMD-Kondensatoren vom Typ ATC100A oder 100B, so haben diese eine sehr geringe Einfügedämpfung. Jedoch haben diese

in Breitbandanwendungen das Problem von Eigenresonanzen. Dies kann man etwas verbessern, indem man die Chip-Kondensatoren nicht liegend, sondern seitlich gekippt einbaut (**Bild 3**).

In den einzelnen Teilbildern von Bild 3 sind jeweils die Orientierung (Montagerichtung) der ATC-Kondensatoren ATC100B und darunter ATC100A gezeigt. Jeweils im Hintergrund sind die Eigenresonanzkurven über der Frequenzachse dargestellt.

Um die Eigenresonanzen der ATC-Kon-

Franco Rota, I2 FHW, Rauschquelle ...

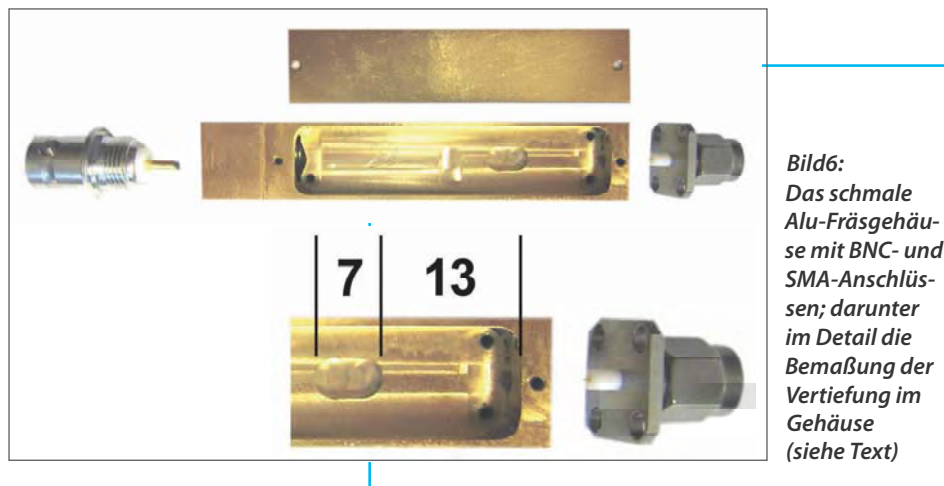

densatoren zu vermeiden, wurde nach Alternativen Ausschau gehalten, die möglichst keine Resonanzstellen und ein niedrigeres Q haben. Viele Bauteile wurden überprüft und gemessen, bis sich folgendes Ergebnis zeigte: Multilayer-Kondensatoren (Klasse 1) in der Größe 0805 mit Material NPO zeigen hier, also für Kleinleistungsanwendung, das beste Verhalten, (sie sind jedoch für HF-Leistungsanwendungen oder für rauscharme Verstärker ungeeignet!).

Gewählt wurde hier die Parallelschaltung von zwei 1000 pF-Kondensatoren um auch nach unten minimal bis 10 MHz zu kommen.

Speziell für Breitband-Anwendungen wird von ATC ein 100 nF-Kondensator in der Bauform 0402 [3] angeboten; nachdem dies jedoch ein Spezialbauteil ist, wurden die oben beschriebenen leichter verfügbaren Bauteile bevorzugt.

Die geringe Einfügedämpfung der 1 nF-Kondensatoren ist in **Bild 4** dargestellt. Die Parallelschaltung der beiden Kondensatoren bringt auf 10,5 GHz (Marker C) eine Einfügedämpfung von lediglich 0,2 dB; das ist für dieses Projekt in Ordnung - und das zu einem günstigen Preis.

2.4. Die Leiterplatte

Der Rauschgenerator sollte eigentlich eine passive Schaltung sein, weshalb keine teure Teflon-Leiterplatte erforderlich ist. Außerdem sind die Leitungslängen sehr kurz und die verursachten Verluste noch akzeptabel - also kein Teflon.

Gewählt wurde hier ein Keramik-Laminat, was für HF-Anwendungen durchaus üblich ist, mit einem ϵ_r von 3,40. Dieses gibt es von verschiedenen Herstellern mit vergleichbaren Eigenschaften: ROGERS RO4003 oder RO4350, Arlon 25N



Bild 6b: Die bestückte Leiterplatte fertig eingebaut in das Fräsgehäuse; darunter das „Endprodukt“ mit externem Dämpfungslid (rechts)

u.s.w. jeweils mit einer Stärke von 30 mils (0,75 mm).

Um auch wirklich noch das 10 GHz-Band abdecken zu können, ist es erforderlich die Massefläche um R3, R4, R5 und L1 zu entfernen; die Maße sind 7 mm x 4 mm (**Bild 5**).

2.5. Das Metallgehäuse

Die Bauteile des Rauschgenerators werden in ein sehr kleines gefrästes Aluminiumgehäuse eingebaut. Leider verhält sich jedes Gehäuse wie ein Hohlleiter mit etlichen Ausbreitungsmoden. Für höhere Frequenzen oder für mittelgroße Gehäuse wird die HF-Schaltung ebenfalls etliche sekundäre Ausbreitungsmodus auf verschiedensten Frequenzen haben.

Da jedes Gehäuse eine unterschiedliche Größe und Form hat und die Arbeitsfre-

quenzen der eingebauten Schaltungen unterschiedlich sind, ist die Berechnung der sekundären Ausbreitungsmodi sehr schwierig.

Um dieses Problem zu umgehen, werden häufig Mikrowellenabsorbermaterialien (z.B. leitfähiger Schaumstoff) eingesetzt, die z.B. in den Gehäusedeckel geklebt werden. Damit versucht man mögliche Resonanzen zu bedämpfen oder zu verhindern.

Der Versuch, all diesen Problemen aus dem Weg zu gehen, führte zu einem sehr kleinen Gehäuse, das problemlos bis 10 GHz einsetzbar ist. Möchte jemand die Innenmaße größer gestalten, wird wieder Absorbermaterial notwendig werden. Weiterhin ist es notwendig, einen 3 mm tiefen Spalt (7 mm x 4 mm) unter den Widerständen R3, R4, R5 und L1 aus dem Gehäuseboden zu fräsen, damit der Abstand zur Massefläche größer wird.

Franco Rota, I2 FHW, Rauschquelle ...



Bild 7:
Hier sieht man die Rauschpegel bei 8 mA bzw. 10 mA Diodenstrom; Bereich: 10 MHz bis 3 GHz bei 1 dB/Div.

3. Der Bias-Strom

Der Nominalwert sollte bei etwa 8 mA liegen. Bei den Tests stellte sich etwas sehr eigenartiges bezüglich des Ausgangsrauschpegels heraus: erhöht man den Diodenstrom, so nimmt der Pegel mit etwa 0,5 dB/mA ab bis zu etwa 9 GHz, darüber zeigt sich jedoch der entgegengesetzte Effekt - der Pegel steigt!

Den Unterschied des Ausgangs-ENR von etwa 1 dB bei einem BIAS-Strom von 8 bzw. 10 mA zeigt **Bild 7**. Eine Erweiterung des Frequenzbereiches um etwa 500 MHz bei einem BIAS-Strom von 8 bzw. 10 mA zeigt **Bild 8**. Weiterhin sieht man den Rückgang des Pegels um etwa 1 dB bei 10 mA anstelle von 8 mA bei etwa gleichbleibender Kurvenform.

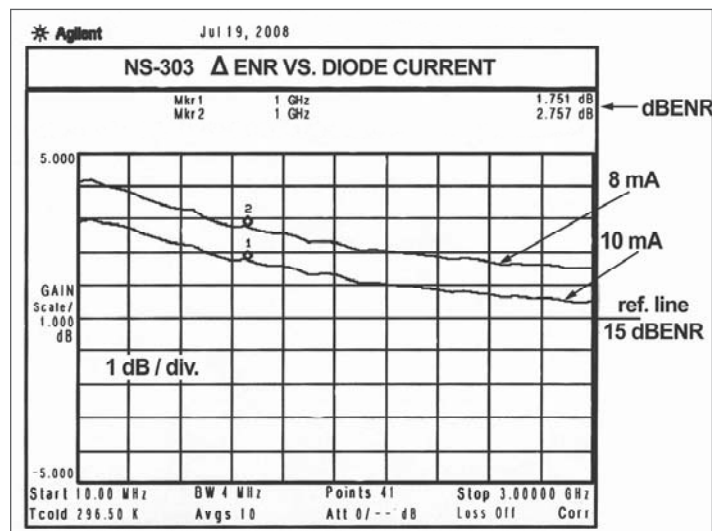
Natürlich kann man beim Abgleich etwas

mit dem Strom „spielen“ um so den ENR-Pegel zu optimieren. Man muss sich also beim Abgleich entscheiden, ob man eher auf 1 dB-Ausgangspegel verzichten kann zugunsten eines erweiterten Frequenzbereiches bis einschließlich 3-cm-Band, oder ob man mehr Pegel haben möchte und dann eben nicht bis 10 GHz kommt.

Den BIAS-Strom kann man einfach direkt an der BNC-Eingangsbuchse messen, wenn man 28 V-DC von einem normalen Netzteil anlegt; der gemessene Strom ist mehr oder weniger genau der Strom, der durch die Diode fließt.

4. Testergebnisse

Im Rahmen dieses Projekts wurden 20 Rauschgeneratoren aufgebaut und getestet. Die Messergebnisse für



Bild 8:
Der Ausgangs-
Rauschpegel bei
verschiedenen
Diodenströmen,
hier dargestellt
bis 11 GHz
bei 1 dB/Div.

alle Geräte waren nahezu identisch. Die Messkurven in **Bild 9** wurden mit einem internen 6 dB und einem externen 8 dB-Dämpfungsglied (MaCom oder Narda DC-18 GHz) erstellt.

Ein typischer Ausgangs-Rauschpegel kann z.B. $15 \text{ dB}_{\text{ENR}} \pm 1,5 \text{ dB}$ oder $15 \text{ dB}_{\text{ENR}} \pm 2 \text{ dB}$ oder $15 \text{ dB}_{\text{ENR}} + 1/-2 \text{ dB}$ sein, wobei eine Pegelschwankung von $\pm 1,5$ oder $\pm 2 \text{ dB}$ ein normaler Wert ist.

Die Rückflussdämpfung am Ausgang hängt hauptsächlich vom externen Dämpfungsglied ab. So konnten Werte von 30 dB bis 5 GHz, 28 dB bis 8 GHz und 25 (-28 dB) bei 10 GHz gemessen werden.

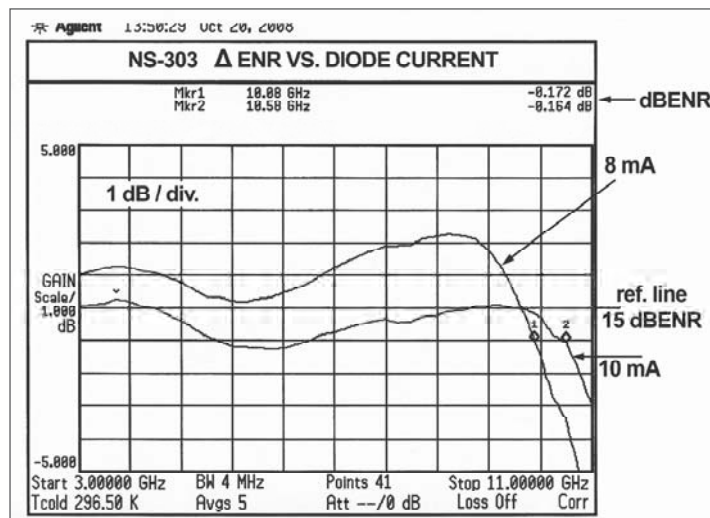
Hierbei gilt ganz einfach, dass jedes dB mehr am externen Dämpfungsglied die Rückflussdämpfung gleich um 2 dB verbessert. Verwendet man beispiels-

weise ein externes Dämpfungsglied von 17 oder 18 dB kann man eine sehr gute Rückflussdämpfung in der Größenordnung $>30 - 35 \text{ dB}$ erreichen; das Rauschsignal liegt dann bei etwa $5 \text{ dB}_{\text{ENR}}$.

5. Abgleich

Der Abgleich einer Rauschquelle ist leider etwas aufwendiger.

Wenn man sich die Daten z.B. eines HF-Signalgenerators ansieht, findet man eine Genauigkeit des Ausgangssignals von typ. $\pm 1 - 1,5 \text{ dB}$; das wird auch weithin akzeptiert. Sehr genaue Leistungsmessgeräte erreichen eine Genauigkeit von $\pm 0,5 \text{ dB}$ oder sogar besser.

Möchte man allerdings die Rauschzahl messen, liegen die Anforderungen noch etwas höher; das bedeutet, dass die

Franco Rota, I2 FHW, Rauschquelle ...



Bild 9:
Typische Kurven
zweier verschiedener
Rauschgeneratoren;
Bereich 10 MHz bis
10,5 GHz bei 1 dB/Div.

Rauschquelle einen sehr genau definierten Pegel liefern muss.

Für die klassischen Rauschquellen, wie 346A, B oder C gibt AGILENT eine ENR-Unsicherheit von $\pm 0,2$ dB (bei $0,01$ dB/°C) und $0,15$ dB maximal an. Für den neuen Rauschzahl-Analysator N8975A werden Rauschquellen der neuen N4000er-Serie eingesetzt.

Verwendet man im Labor ein Rauschzahlmessgerät N8975A mit einer Rauschquelle N4001, so kann man beispielsweise typ. Genauigkeiten der Messung von $\pm 0,1$ dB bis 3 GHz und $0,15$ dB bis 10 GHz erreichen.

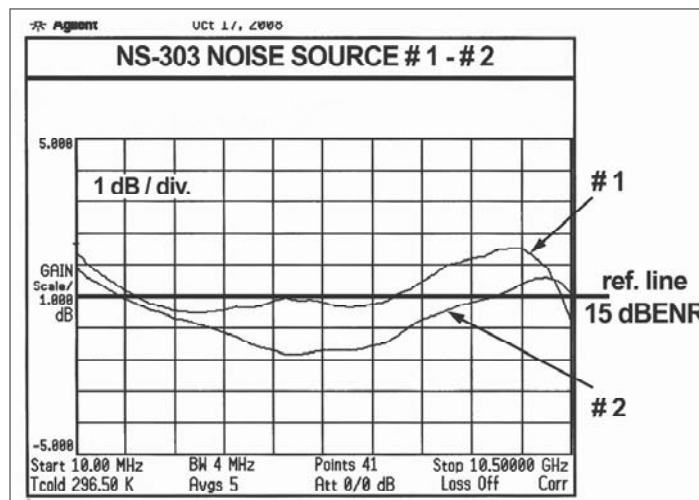
Das bedeutet, dass der Abgleich der hier beschriebenen Rauschquelle idealer Weise mit einer sehr guten Rauschquelle als Vergleich vorgenommen werden sollte. Also wird die Eigenbau-Rauschquelle mit einer kalibrierten Rauschquelle im

Aufbau mit einem rauscharmen Vorverstärker und einem typischen Rauschzahlmessgerät verglichen.

Beispiel:

Man verwendet einen rauscharmen Verstärker mit einer bekannten Rauschzahl von $0,6$ dB und die kalibrierte Rauschquelle liefert $15,35$ dB_{ENR}. Wechselt man nun die Rauschquellen und schließt die Eigenbauversion an, misst man z.B. eine Rauschzahl von $0,75$ dB. Das bedeutet, dass die eigene Rauschquelle einen Pegel von: $15,35$ dB + $(0,75$ dB - $0,6$ dB) = $15,50$ dB_{ENR} hat.

6. Weitere Anwendungen

Eine Rauschquelle kann auch als Breitband-Rauschgenerator zusammen



mit einem Spektrum-Analysator wie ein „Tracking-Generator“ für skalare Anwendungen eingesetzt werden.

Natürlich ist das kein echter „Tracking-Generator“, weil er ja ganz anders arbeitet. Das Problem liegt einfach darin, dass man einen Frequenzbereich über 3 Dekaden erreichen sollte, also von 10 MHz bis 10 GHz mit einem linearen Verstärker mit mindestens 50 dB Verstärkung!

Es gibt heutzutage entsprechende MMICs, die hierfür geeignet wären, wie die Typen ERA-1, ERA-2, MGA 86576 u.s.w. Problematisch ist jedoch, eine sehr flache Verstärkungskurve über den großen Frequenzbereich zu erhalten und die Schwingneigung bei so hohen Verstärkungen zu verhindern.

So eine Baugruppe kann natürlich ein sehr nützliches Hilfsmittel für die unterschiedlichsten Messaufgaben sein. Es kann beim Filterabgleich mit Spektralanalysatoren eingesetzt werden oder zur Messung der Rückflussdämpfung - und das bis 10 GHz.

7. Literaturhinweise

Nachfolgend noch Links und Literaturhinweise zum Artikel:

[1] VHF-Communications 1/2007
„Noise source diodes“

[2] For those who need more information about the mismatch uncertainty in noise figure measurement I suggest 3 application notes:

- Ham Radio, August 1978,
- Noise figure measurement accuracy AN57-2 Agilent,
- Calculating mismatch uncertainty, Microwave Journal May 2008

[3] R.F. Elettronica web site catalogue www.rfmicrowave.it (capacitors section)

[4] VHF-Communications 4/2004
„Franco's finest microwave absorber“

Übersetzung Englisch -
Deutsch: Eberhard L.
Smolka, DB 7 UP

ANZEIGE



Fachversand für Funkzubehör
Jahnstr. 7, D-91083 Baiersdorf
Tel. 09133-77980, Fax 09133-779833
Email: info@ukwberichte.com
www.ukw-berichte.de