

# IR2125

## CURRENT LIMITING SINGLE CHANNEL DRIVER

### Features

- Floating channel designed for bootstrap operation  
 Fully operational to +500V  
 Tolerant to negative transient voltage  
 dV/dt immune
- Gate drive supply range from 12 to 18V
- Undervoltage lockout
- Current detection and limiting loop to limit driven power transistor current
- Error lead indicates fault conditions and programs shutdown time
- Output in phase with input

### Description

The IR2125 is a high voltage, high speed power MOSFET and IGBT driver with over-current limiting protection circuitry. Proprietary HVIC and latch immune CMOS technologies enable ruggedized monolithic construction. Logic inputs are compatible with standard CMOS or LSTTL outputs. The output driver features a high pulse current buffer stage designed for minimum driver cross-conduction. The protection circuitry detects over-current in the driven power transistor and limits the gate drive voltage. Cycle by cycle shutdown is programmed by an external capacitor which directly controls the time interval between detection of the over-current limiting conditions and latched shut-

### Product Summary

|                                  |                         |
|----------------------------------|-------------------------|
| <b>V<sub>OFFSET</sub></b>        | <b>500V max.</b>        |
| <b>I<sub>O+/-</sub></b>          | <b>1A / 2A</b>          |
| <b>V<sub>OUT</sub></b>           | <b>12 - 18V</b>         |
| <b>V<sub>CSth</sub></b>          | <b>230 mV</b>           |
| <b>t<sub>on/off</sub> (typ.)</b> | <b>150 &amp; 150 ns</b> |

### Package

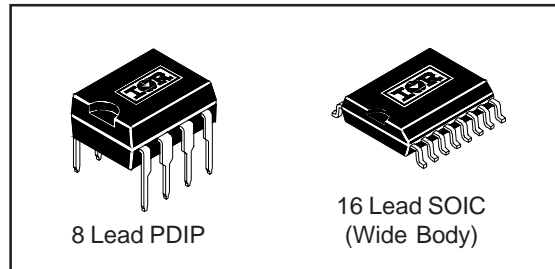

down. The floating channel can be used to drive an N-channel power MOSFET or IGBT in the high or low side configuration which operates up to 500 volts.

### Typical Connection

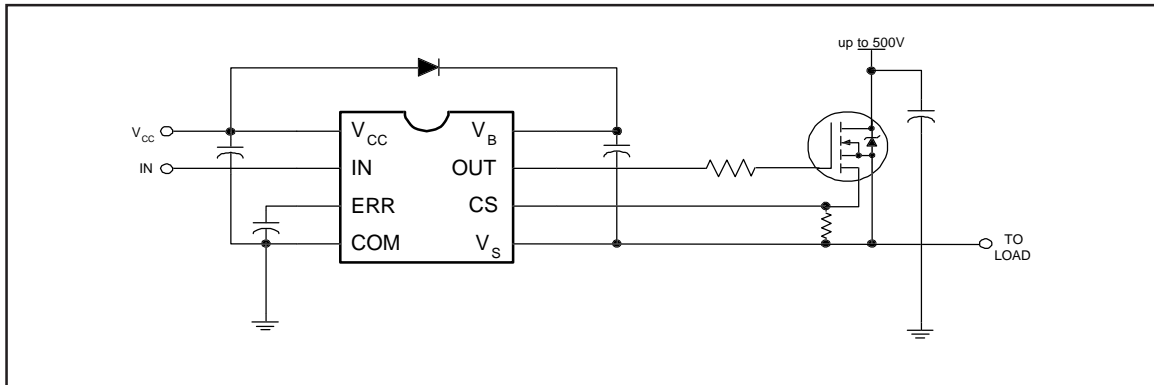

# IR2125

## Absolute Maximum Ratings

Absolute Maximum Ratings indicate sustained limits beyond which damage to the device may occur. All voltage parameters are absolute voltages referenced to COM. The Thermal Resistance and Power Dissipation ratings are measured under board mounted and still air conditions.

| Symbol              | Definition   | Min.                 | Max.                  | Units |
|---------------------|--|----------------------|-----------------------|-------|
| V <sub>B</sub>      | High Side Floating Supply Voltage                                | -0.3                 | 525                   | V     |
| V <sub>S</sub>      | High Side Floating Offset Voltage                                | V <sub>B</sub> - 25  | V <sub>B</sub> + 0.3  |       |
| V <sub>HO</sub>     | High Side Floating Output Voltage                                | V <sub>S</sub> - 0.3 | V <sub>B</sub> + 0.3  |       |
| V <sub>CC</sub>     | Logic Supply Voltage   | -0.3                 | 25                    |       |
| V <sub>IN</sub>     | Logic Input Voltage  | -0.3                 | V <sub>CC</sub> + 0.3 |       |
| V <sub>ERR</sub>    | Error Signal Voltage   | -0.3                 | V <sub>CC</sub> + 0.3 |       |
| V <sub>CS</sub>     | Current Sense Voltage  | V <sub>S</sub> - 0.3 | V <sub>B</sub> + 0.3  |       |
| dV <sub>S</sub> /dt | Allowable Offset Supply Voltage Transient                        | —                    | 50                    | V/ns  |
| P <sub>D</sub>      | Package Power Dissipation @ T <sub>A</sub> ≤ +25°C (8 lead PDIP) | —                    | 1.0                   | W     |
|                     | (16 lead SOIC)   | —                    | 1.25                  |       |
| R <sub>thJA</sub>   | Thermal Resistance, Junction to Ambient (8 lead PDIP)            | —                    | 125                   | °C/W  |
|                     | (16Lead SOIC)  | —                    | 100                   |       |
| T <sub>J</sub>      | Junction Temperature   | —                    | 150                   | °C    |
| T <sub>S</sub>      | Storage Temperature  | -55                  | 150                   |       |
| T <sub>L</sub>      | Lead Temperature (Soldering, 10 seconds)                         | —                    | 300                   |       |

## Recommended Operating Conditions

The Input/Output logic timing diagram is shown in Figure 1. For proper operation the device should be used within the recommended conditions. The V<sub>S</sub> offset rating is tested with all supplies biased at 15V differential.

| Symbol           | Definition                        | Min.                | Max.                | Units |
|------------------|-----------------------------------|---------------------|---------------------|-------|
| V <sub>B</sub>   | High Side Floating Supply Voltage | V <sub>S</sub> + 12 | V <sub>S</sub> + 18 | V     |
| V <sub>S</sub>   | High Side Floating Offset Voltage | Note 1              | 500                 |       |
| V <sub>HO</sub>  | High Side Floating Output Voltage | V <sub>S</sub>      | V <sub>B</sub>      |       |
| V <sub>CC</sub>  | Logic Supply Voltage              | 0                   | 18                  |       |
| V <sub>IN</sub>  | Logic Input Voltage               | 0                   | V <sub>CC</sub>     |       |
| V <sub>ERR</sub> | Error Signal Voltage              | 0                   | V <sub>CC</sub>     |       |
| V <sub>CS</sub>  | Current Sense Signal Voltage      | V <sub>S</sub>      | V <sub>B</sub>      |       |
| T <sub>A</sub>   | Ambient Temperature               | -40                 | 125                 | °C    |

**Note 1:** Logic operational for V<sub>S</sub> of -5 to +500V. Logic state held for V<sub>S</sub> of -5V to -V<sub>BS</sub>.

### Dynamic Electrical Characteristics

$V_{BIAS} (V_{CC}, V_{BS}) = 15V$ ,  $C_L = 3300 \text{ pF}$  and  $T_A = 25^\circ\text{C}$  unless otherwise specified. The dynamic electrical characteristics are measured using the test circuit shown in Figures 3 through 6.

| Symbol    | Definition                          | Figure | Min. | Typ. | Max. | Units         | Test Conditions   |
|-----------|-------------------------------------|--------|------|------|------|---------------|---|
| $t_{on}$  | Turn-On Propagation Delay           | 7      | —    | 150  | 200  | ns            | $V_{IN} = 0 \text{ \& } 5V$<br>$V_S = 0 \text{ to } 600V$ |
| $t_{off}$ | Turn-Off Propagation Delay          | 8      | —    | 150  | 190  |               |   |
| $t_{sd}$  | ERR Shutdown Propagation Delay      | 9      | —    | 1.7  | 2.2  | ns            |   |
| $t_r$     | Turn-On Rise Time                   | 10     | —    | 43   | 60   |               |   |
| $t_f$     | Turn-Off Fall Time                  | 11     | —    | 26   | 35   |               |   |
| $t_{cs}$  | CS Shutdown Propagation Delay       | 12     | —    | 0.7  | 1.2  | $\mu\text{s}$ |   |
| $t_{err}$ | CS to ERR Pull-Up Propagation Delay | 13     | —    | 9.0  | 12   |               | $C_{ERR} = 270 \text{ pF}$                                |

### Static Electrical Characteristics

$V_{BIAS} (V_{CC}, V_{BS}) = 15V$  and  $T_A = 25^\circ\text{C}$  unless otherwise specified. The  $V_{IN}$ ,  $V_{TH}$  and  $I_{IN}$  parameters are referenced to COM. The  $V_O$  and  $I_O$  parameters are referenced to  $V_S$ .

| Symbol      | Definition  | Figure | Min. | Typ. | Max. | Units         | Test Conditions                                      |
|-------------|---|--------|------|------|------|---------------|--|
| $V_{IH}$    | Logic "1" Input Voltage                               | 14     | 2.2  | —    | —    | V             |  |
| $V_{IL}$    | Logic "0" Input Voltage                               | 15     | —    | —    | 0.8  |               |  |
| $V_{CSTH+}$ | CS Input Positive Going Threshold                     | 16     | 150  | 230  | 320  | mV            |  |
| $V_{CSTH-}$ | CS Input Negative Going Threshold                     | 17     | 130  | 200  | 260  |               |  |
| $V_{OH}$    | High Level Output Voltage, $V_{BIAS} - V_O$           | 18     | —    | —    | 100  |               | $I_O = 0A$   |
| $V_{OL}$    | Low Level Output Voltage, $V_O$                       | 19     | —    | —    | 100  |               | $I_O = 0A$   |
| $I_{LK}$    | Offset Supply Leakage Current                         | 20     | —    | —    | 50   |               | $V_B = V_S = 500V$                                   |
| $I_{QBS}$   | Quiescent $V_{BS}$ Supply Current                     | 21     | —    | 400  | 1000 |               | $V_{IN} = V_{CS} = 0V \text{ or } 5V$                |
| $I_{QCC}$   | Quiescent $V_{CC}$ Supply Current                     | 22     | —    | 700  | 1200 |               | $V_{IN} = V_{CS} = 0V \text{ or } 5V$                |
| $I_{IN+}$   | Logic "1" Input Bias Current                          | 23     | —    | 4.5  | 10   | $\mu\text{A}$ | $V_{IN} = 5V$  |
| $I_{IN-}$   | Logic "0" Input Bias Current                          | 24     | —    | —    | 1.0  |               | $V_{IN} = 0V$  |
| $I_{CS+}$   | "High" CS Bias Current                                | 25     | —    | 4.5  | 10   |               | $V_{CS} = 3V$  |
| $I_{CS-}$   | "Low" CS Bias Current                                 | 26     | —    | —    | 1.0  |               | $V_{CS} = 0V$  |
| $V_{BSUV+}$ | $V_{BS}$ Supply Undervoltage Positive Going Threshold | 27     | 8.5  | 9.2  | 10.0 |               |  |
| $V_{BSUV-}$ | $V_{BS}$ Supply Undervoltage Negative Going Threshold | 28     | 7.7  | 8.3  | 9.0  |               |  |
| $V_{CCUV+}$ | $V_{CC}$ Supply Undervoltage Positive Going Threshold | 29     | 8.3  | 8.9  | 9.6  | V             |  |
| $V_{CCUV-}$ | $V_{CC}$ Supply Undervoltage Negative Going Threshold | 30     | 7.3  | 8.0  | 8.7  |               |  |
| $I_{ERR}$   | ERR Timing Charge Current                             | 31     | 65   | 100  | 130  | $\mu\text{A}$ | $V_{IN} = 5V, V_{CS} = 3V$<br>$ERR < V_{ERR+}$       |
| $I_{ERR+}$  | ERR Pull-Up Current                                   | 32     | 8.0  | 15   | —    | mA            | $V_{IN} = 5V, V_{CS} = 3V$<br>$ERR > V_{ERR+}$       |
| $I_{ERR-}$  | ERR Pull-Down Current                                 | 33     | 16   | 30   | —    |               | $V_{IN} = 0V$  |
| $I_{O+}$    | Output High Short Circuit Pulsed Current              | 34     | 1.0  | 1.6  | —    | A             | $V_O = 0V, V_{IN} = 5V$<br>$PW \leq 10 \mu\text{s}$  |
| $I_{O-}$    | Output Low Short Circuit Pulsed Current               | 35     | 2.0  | 3.3  | —    |               | $V_O = 15V, V_{IN} = 0V$<br>$PW \leq 10 \mu\text{s}$ |

# IR2125

## Functional Block Diagram

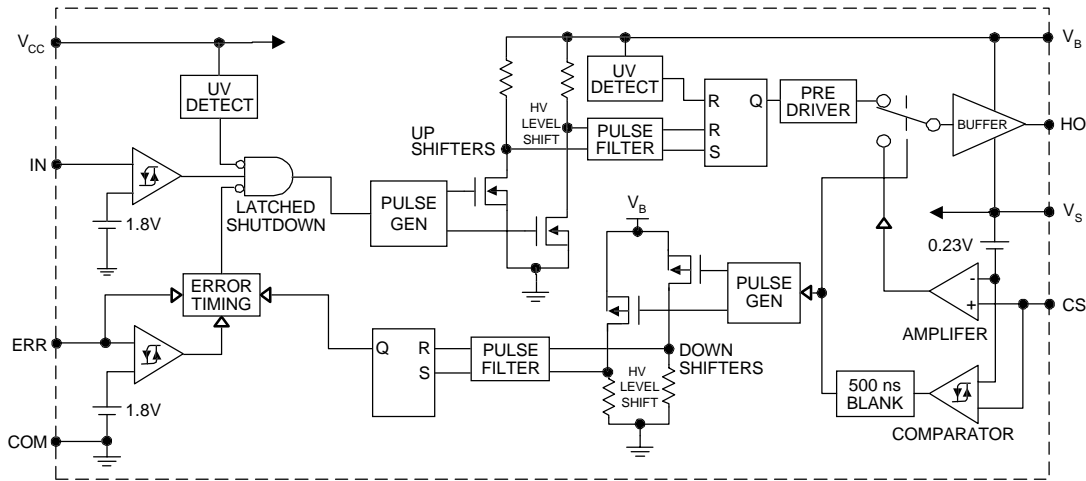

## Lead Definitions

| Symbol          | Description   |
|-----------------|---|
| V <sub>CC</sub> | Logic and gate drive supply   |
| IN              | Logic input for gate driver output (HO), in phase with HO   |
| ERR             | Serves multiple functions; status reporting, linear mode timing and cycle by cycle logic shutdown |
| COM             | Logic ground  |
| V <sub>B</sub>  | High side floating supply   |
| HO              | High side gate drive output   |
| V <sub>S</sub>  | High side floating supply return  |
| CS              | Current sense input to current sense comparator   |

## Lead Assignments

|                    |                                 |
|--------------------|---------------------------------|
| <p>8 Lead PDIP</p> | <p>16 Lead SOIC (Wide Body)</p> |
| <b>IR2125</b>      | <b>IR2125S</b>                  |
| <b>Part Number</b> |                                 |

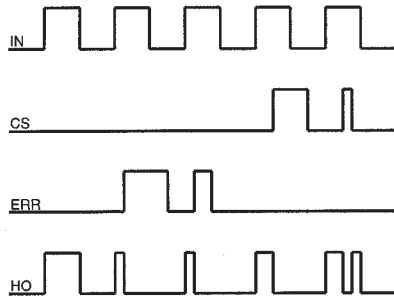

**Figure 1. Input/Output Timing Diagram**

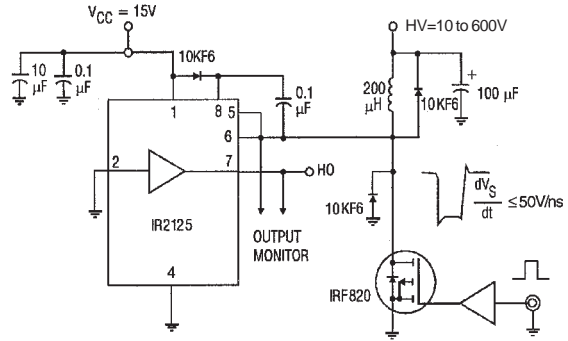

**Figure 2. Floating Supply Voltage Transient Test Circuit**

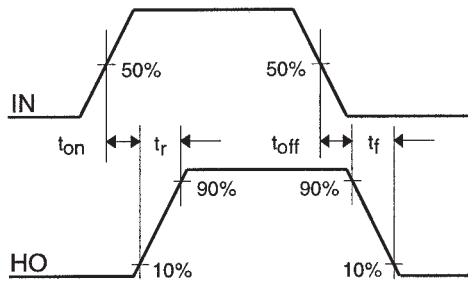

**Figure 3. Switching Time Waveform Definitions**

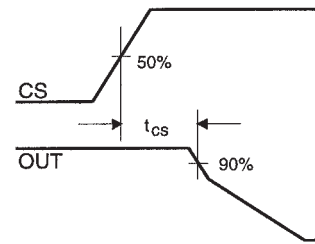

**Figure 4. ERR Shutdown Waveform Definitions**

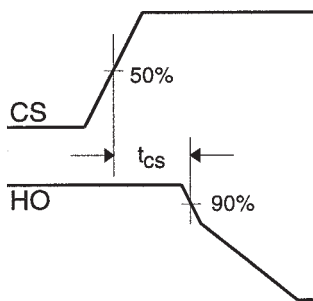

**Figure 5. CS Shutdown Waveform Definitions**

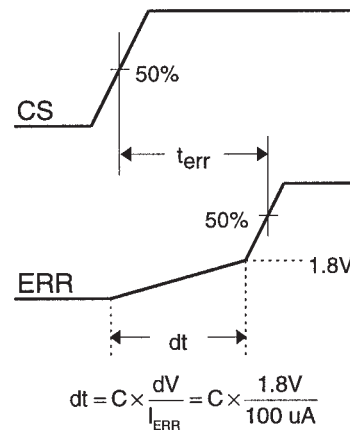

**Figure 6. CS to ERR Waveform Definitions**

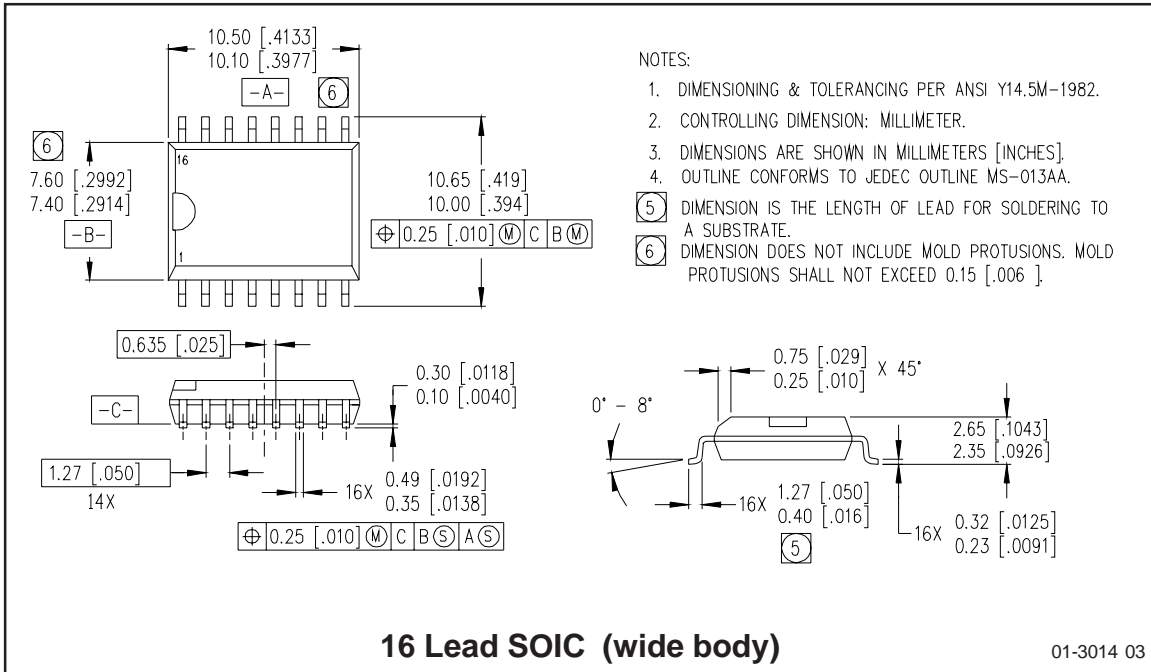
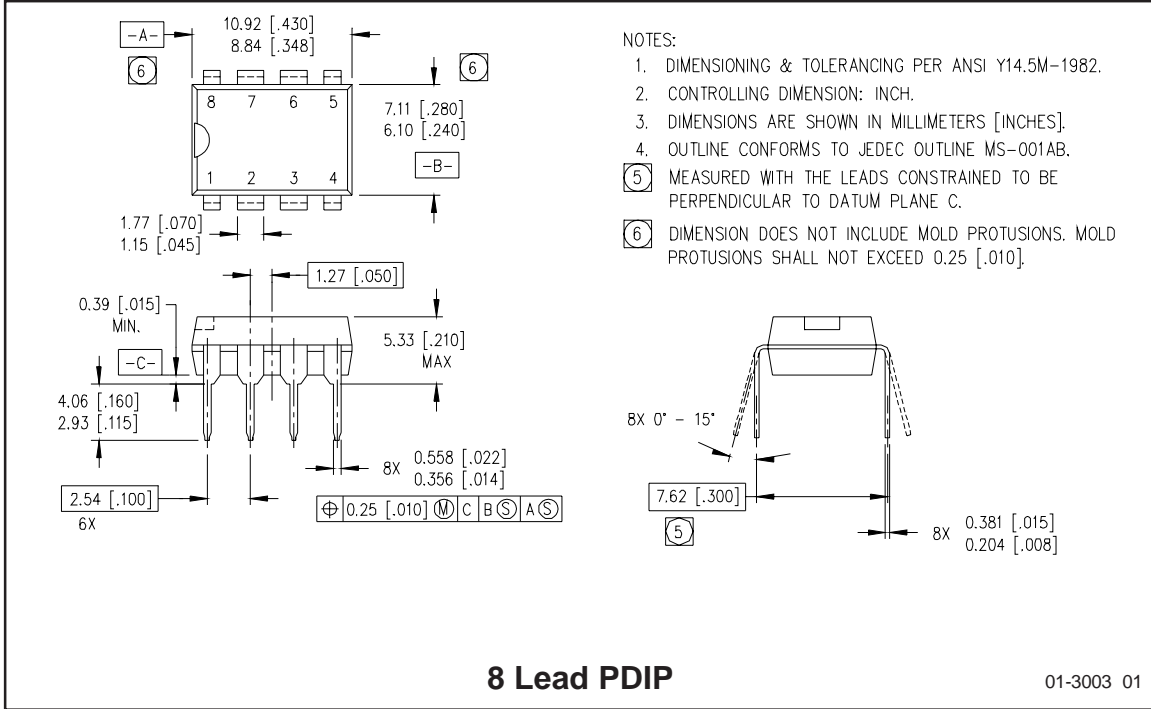

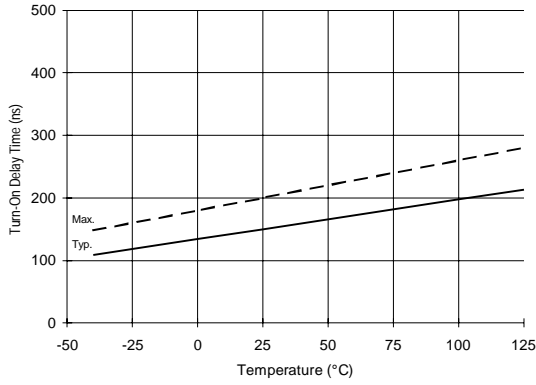

Figure 7A. Turn-On Time vs. Temperature

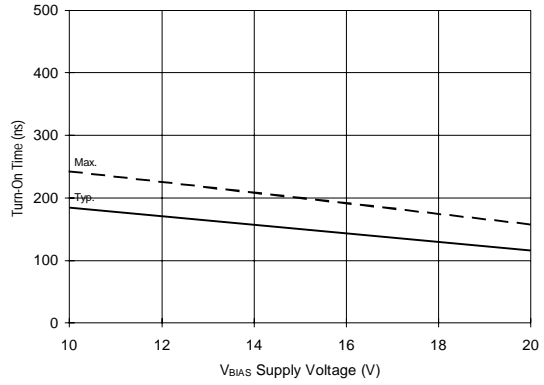

Figure 7B. Turn-On Time vs. Voltage

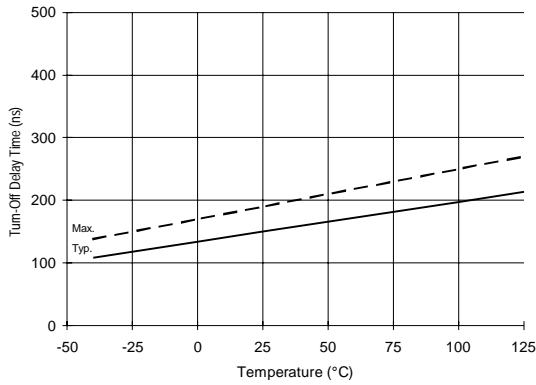

Figure 8A. Turn-Off Time vs. Temperature

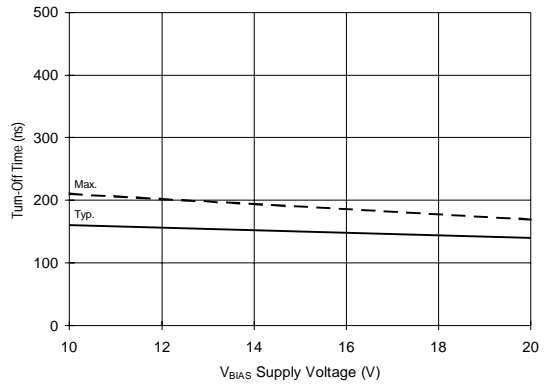

Figure 8B. Turn-Off Time vs. Voltage

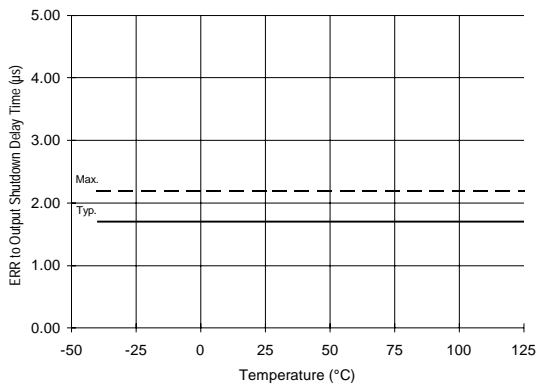

Figure 9A. ERR to Output Shutdown vs. Temperature

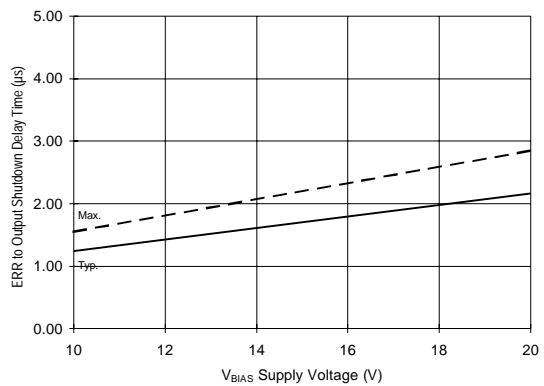

Figure 9B. ERR to Output Shutdown vs. Voltage

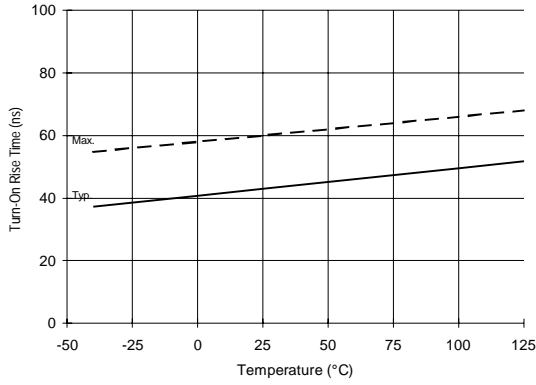

Figure 10A. Turn-On Rise Time vs. Temperature

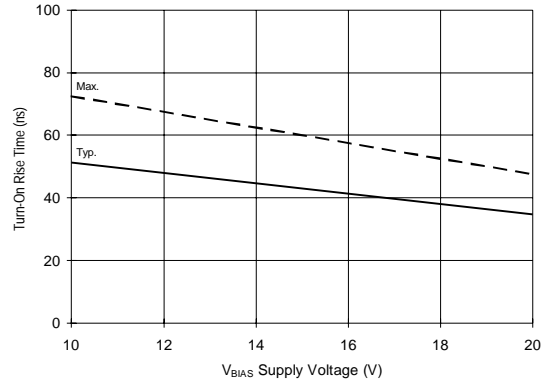

Figure 10B. Turn-On Rise Time vs. Voltage

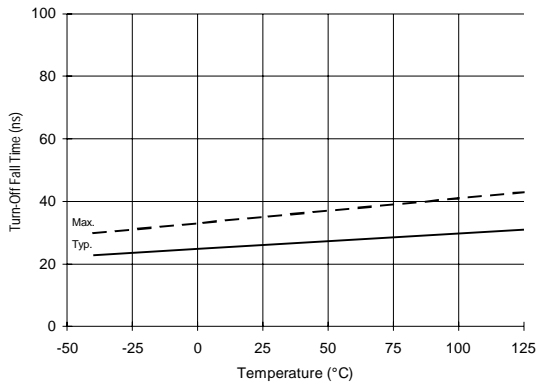

Figure 11A. Turn-Off Fall Time vs. Temperature

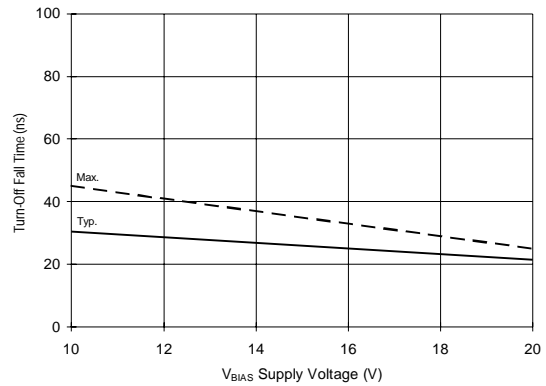

Figure 11B. Turn-Off Fall Time vs. Voltage

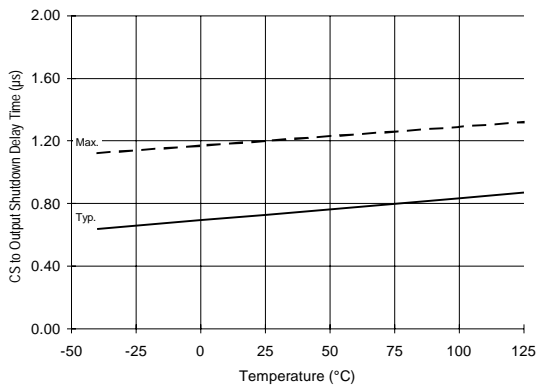

Figure 12A. CS to Output Shutdown vs. Temperature

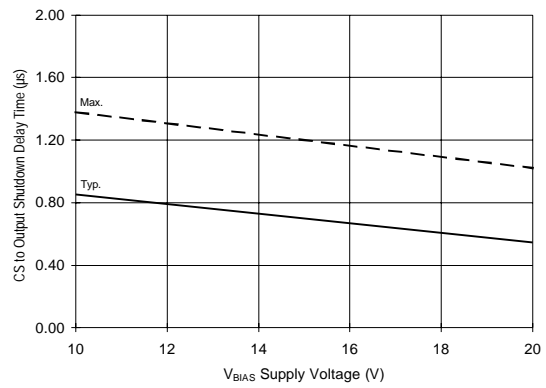

Figure 12B. CS to Output Shutdown vs. Voltage



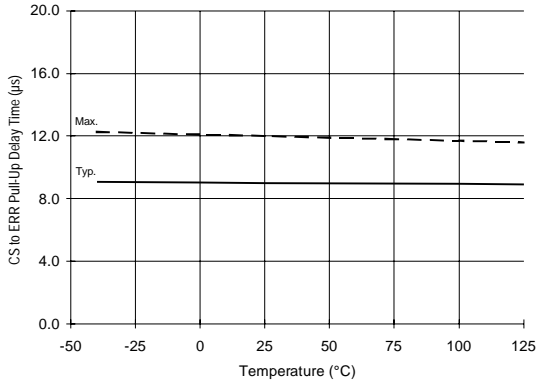

Figure 13A. CS to ERR Pull-Up vs. Temperature

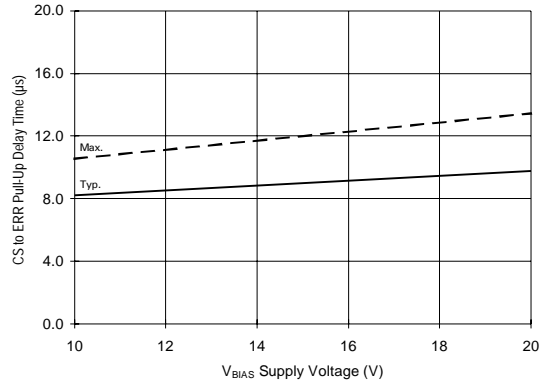

Figure 13B. CS to ERR Pull-Up vs. Voltage

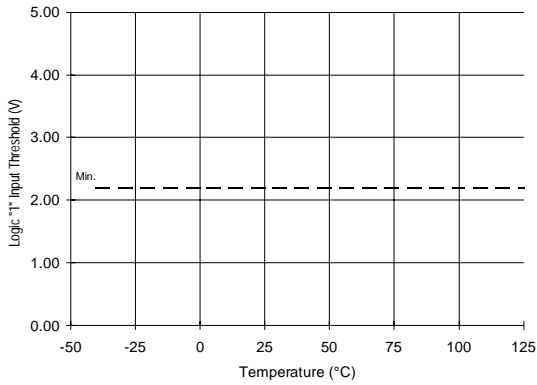

Figure 14A. Logic "1" Input Threshold vs. Temperature

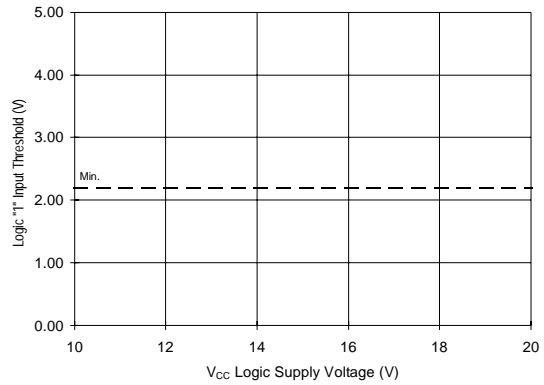

Figure 14B. Logic "1" Input Threshold vs. Voltage

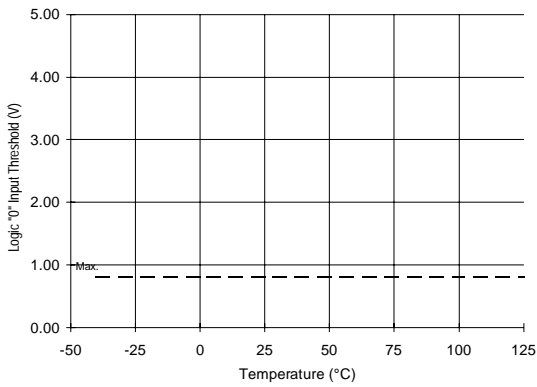

Figure 15A. Logic "0" Input Threshold vs. Temperature

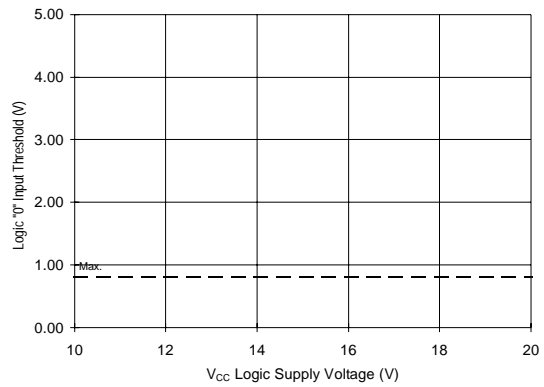
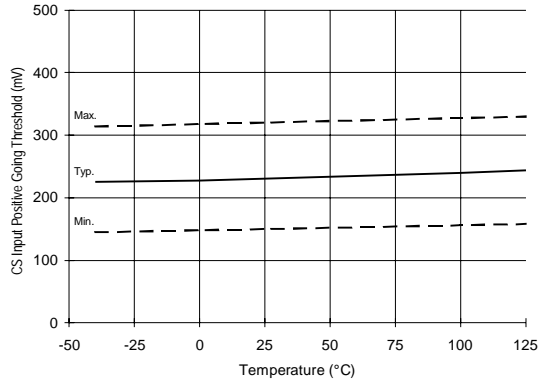
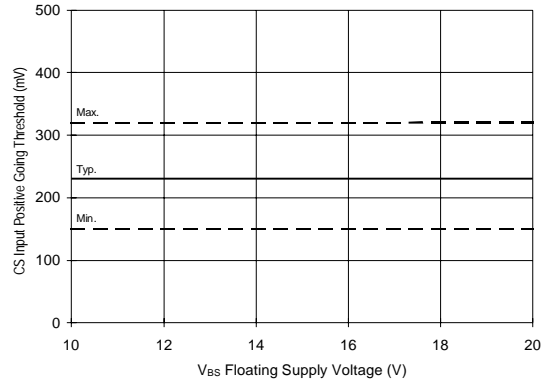

Figure 15B. Logic "0" Input Threshold vs. Voltage

# IR2125



**Figure 16A. CS Input Threshold (+) vs. Temperature**



**Figure 16B. CS Input Threshold (+) vs. Voltage**

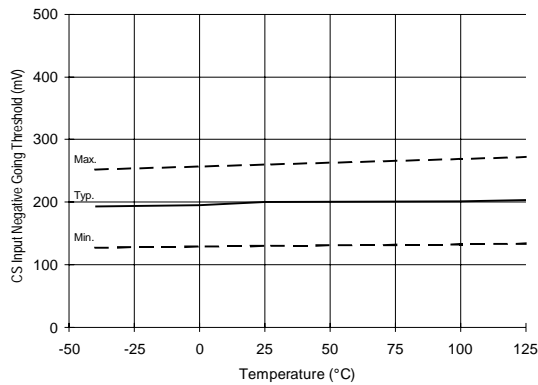

**Figure 17A. CS Input Threshold (-) vs. Temperature**

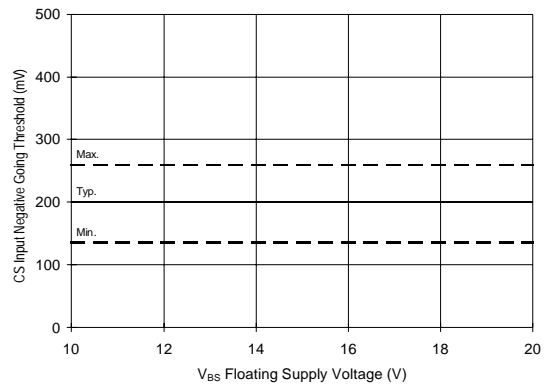

**Figure 17B. CS Input Threshold (-) vs. Voltage**

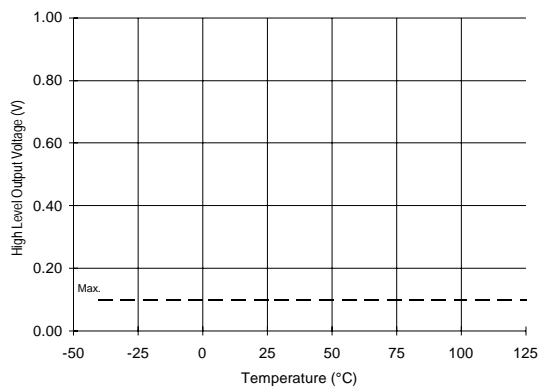

**Figure 18A. High Level Output vs. Temperature**

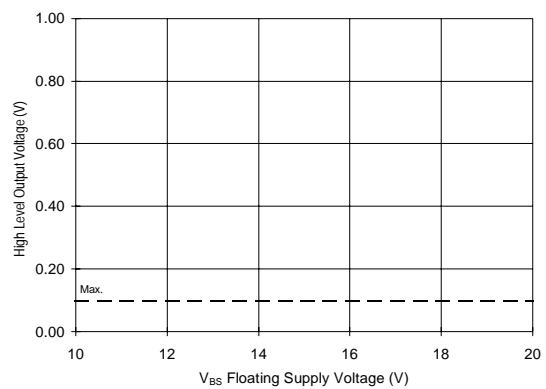

**Figure 18B. High Level Output vs. Voltage**

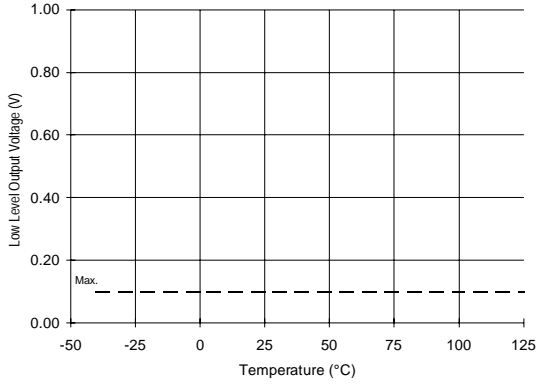

Figure 19A. Low Level Output vs. Temperature

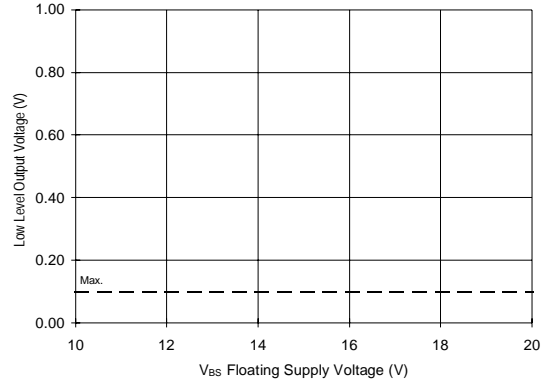

Figure 19B. Low Level Output vs. Voltage

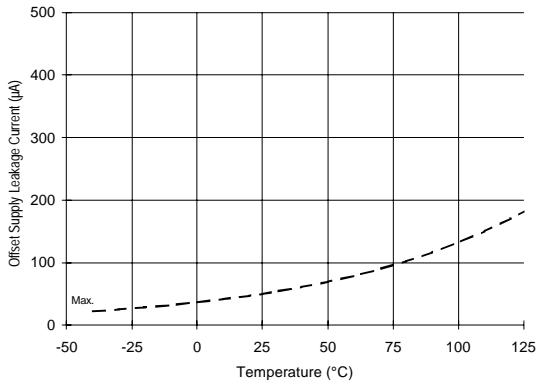

Figure 20A. Offset Supply Current vs. Temperature

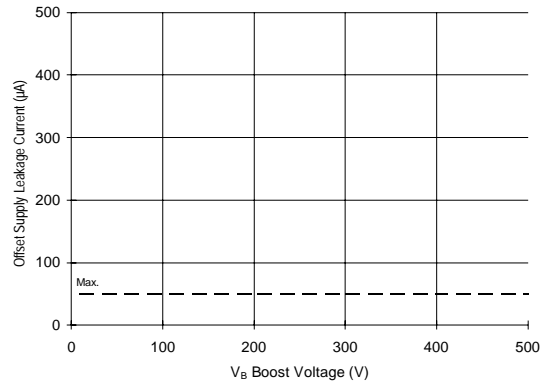

Figure 20B. Offset Supply Current vs. Voltage

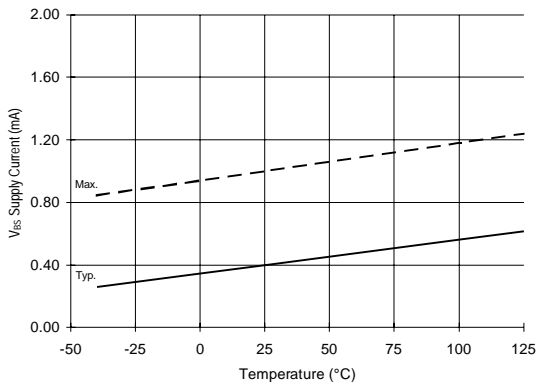

Figure 21A. V<sub>BS</sub> Supply Current vs. Temperature

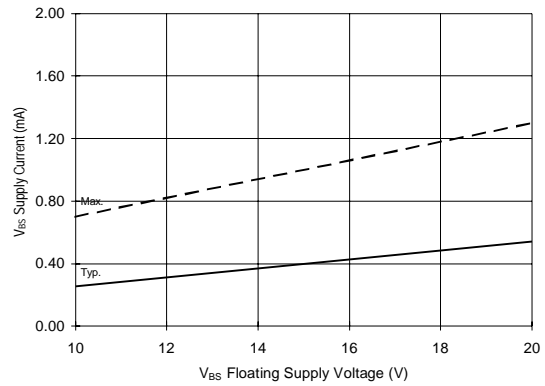

Figure 21B. V<sub>BS</sub> Supply Current vs. Voltage

# IR2125

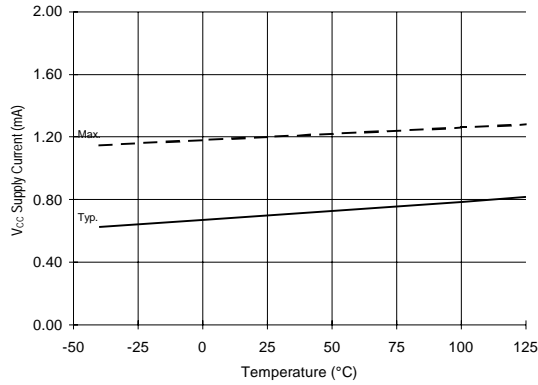

Figure 22A. V<sub>CC</sub> Supply Current vs. Temperature

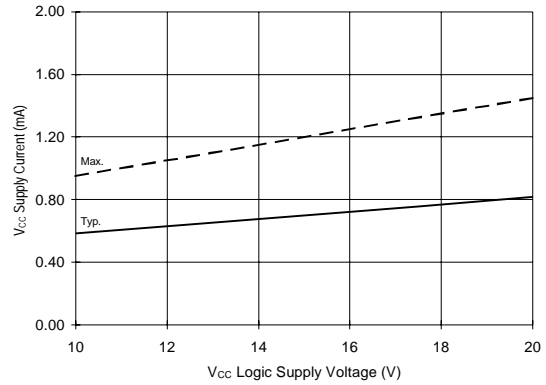

Figure 22B. V<sub>CC</sub> Supply Current vs. Voltage

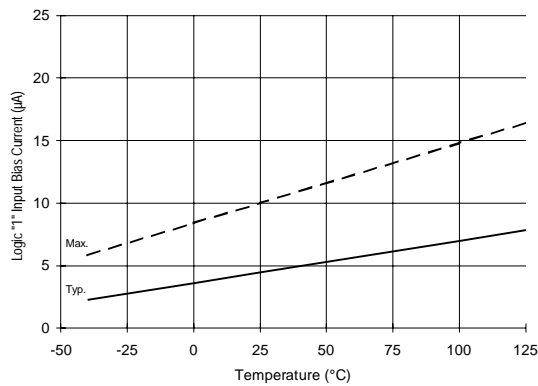

Figure 23A. Logic "1" Input Current vs. Temperature

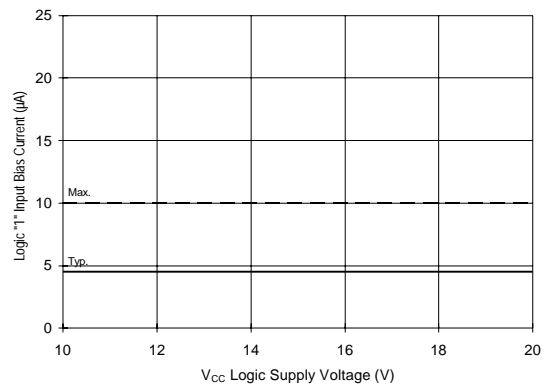

Figure 23B. Logic "1" Input Current vs. Voltage

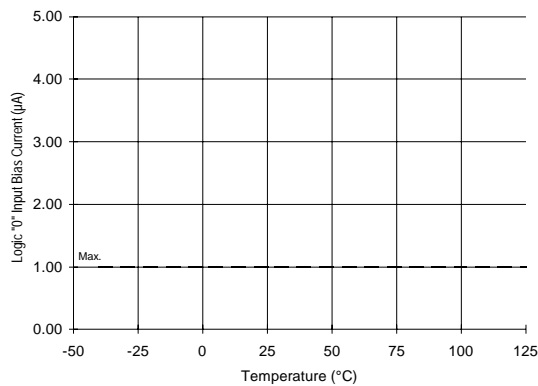

Figure 24A. Logic "0" Input Current vs. Temperature

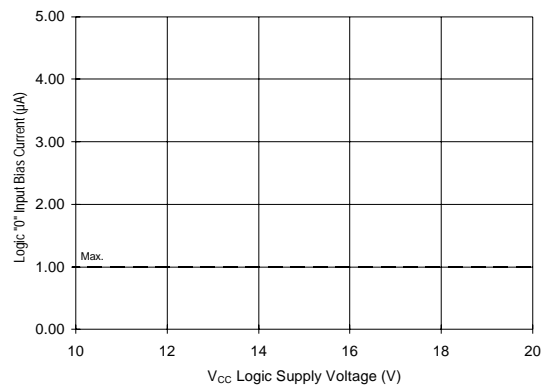

Figure 24B. Logic "0" Input Current vs. Voltage

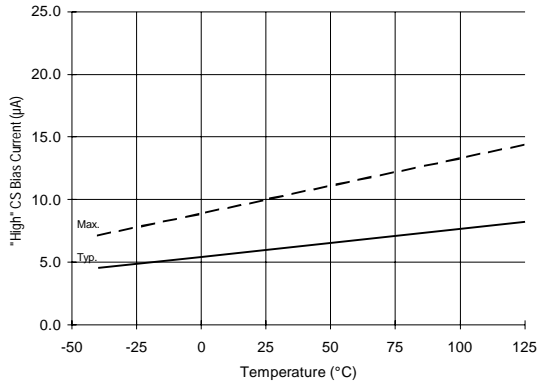

Figure 25A. "High" CS Bias Current vs. Temperature

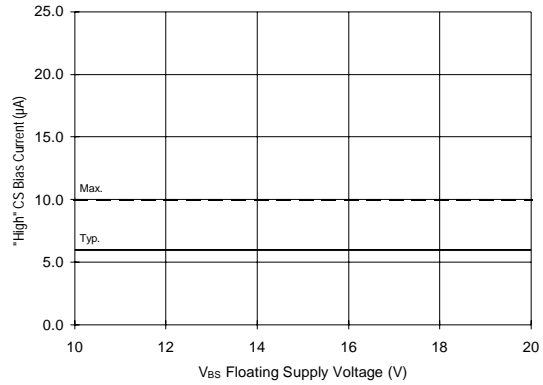

Figure 25B. "High" CS Bias Current vs. Voltage

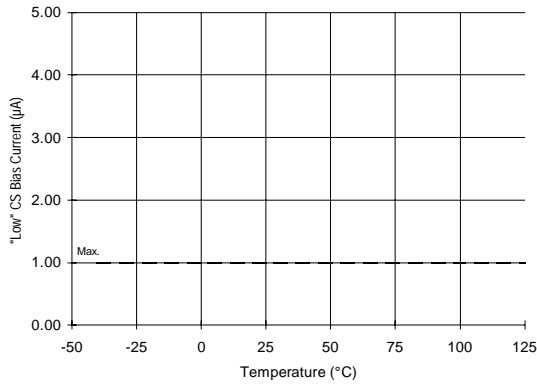

Figure 26A. "Low" CS Bias Current vs. Temperature

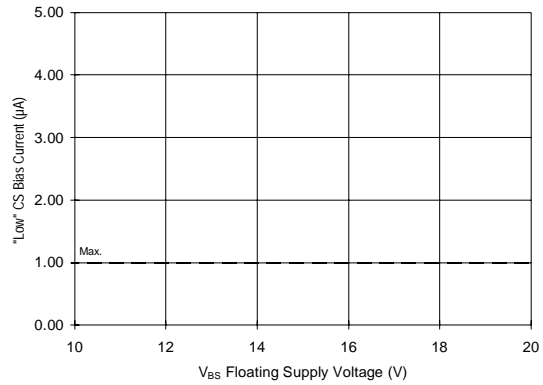

Figure 26B. "Low" CS Bias Current vs. Voltage

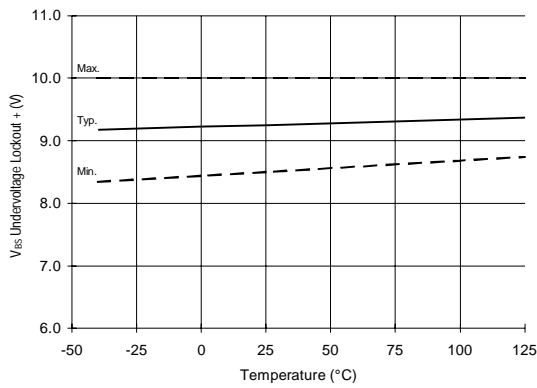

Figure 27. V<sub>BS</sub> Undervoltage Lockout (+) vs. Temperature

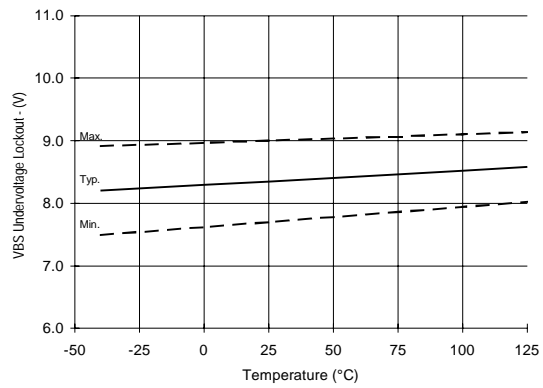

Figure 28. V<sub>BS</sub> Undervoltage Lockout (-) vs. Temperature

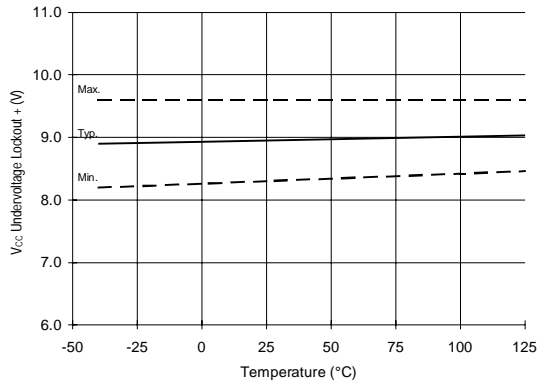

Figure 29.  $V_{CC}$  Undervoltage (+) vs. Temperature

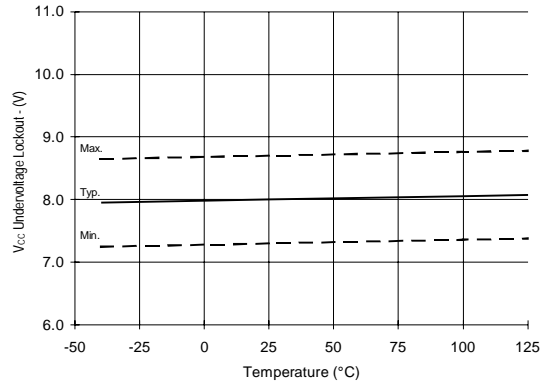

Figure 30.  $V_{CC}$  Undervoltage (-) vs. Temperature

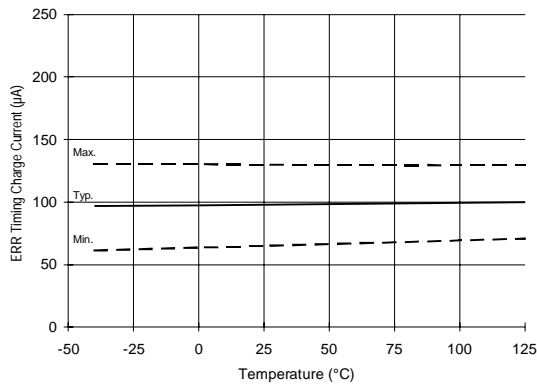

Figure 31A. ERR Timing Charge Current vs. Temperature

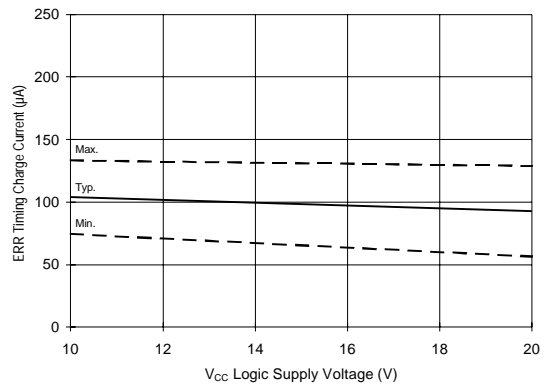

Figure 31B. ERR Timing Charge Current vs. Voltage

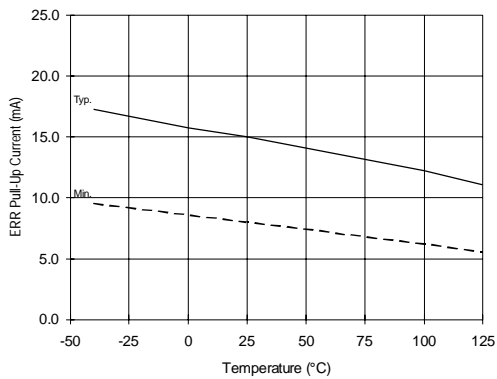

Figure 32A. ERR Pull-Up Current vs. Temperature

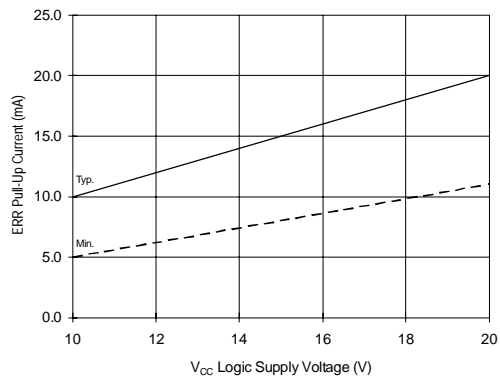
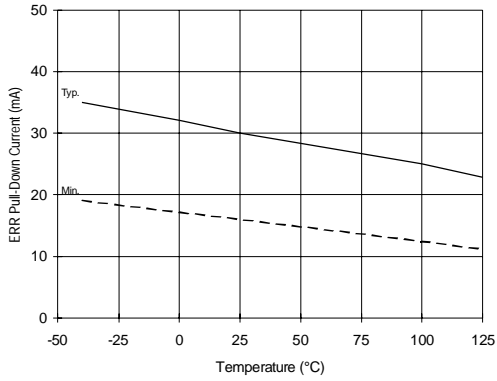
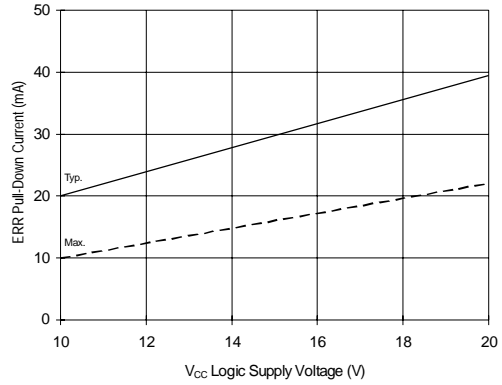

Figure 32B. ERR Pull-Up Current vs. Voltage



**Figure 33A. ERR Pull-Down Current vs. Temperature**



**Figure 33B. ERR Pull-Down Current vs. Voltage**

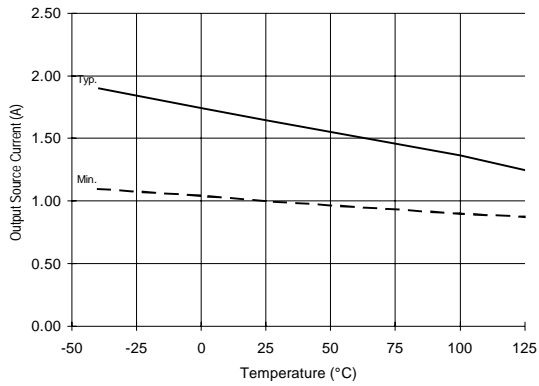

**Figure 34A. Output Source Current vs. Temperature**

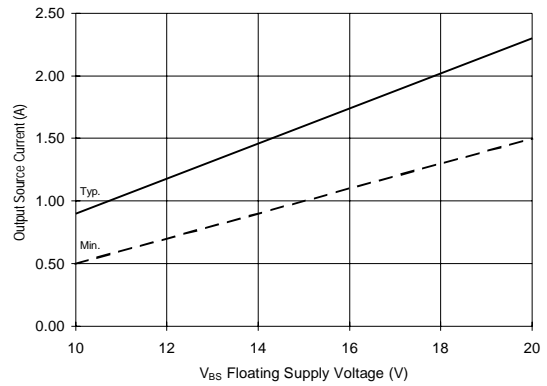

**Figure 34B. Output Source Current vs. Voltage**

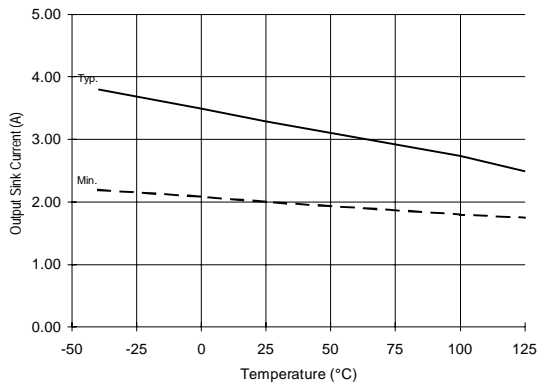

**Figure 35A. Output Sink Current vs. Temperature**

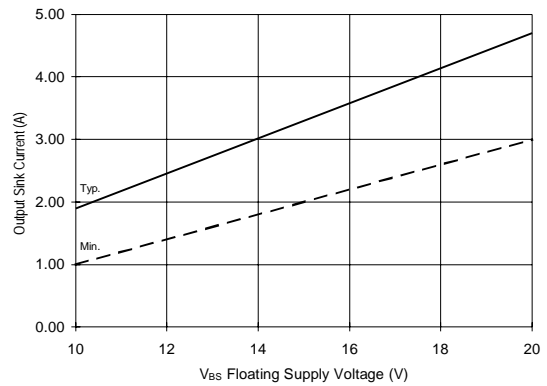

**Figure 35B. Output Sink Current vs. Voltage**

# IR2125

International  
**IR** Rectifier

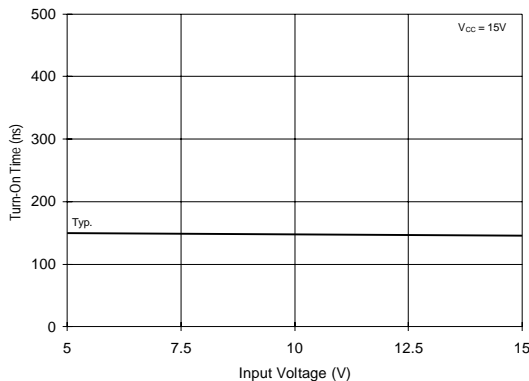

Figure 36A. Turn-On Time vs. Input Voltage

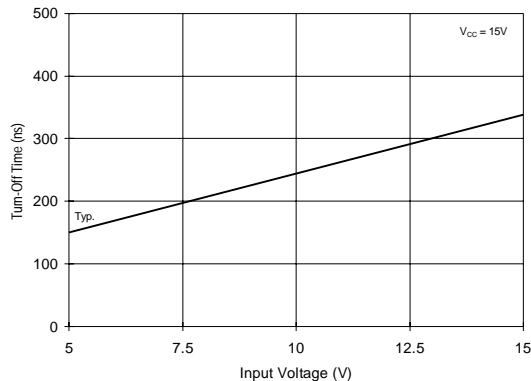

Figure 36B. Turn-Off Time vs. Input Voltage

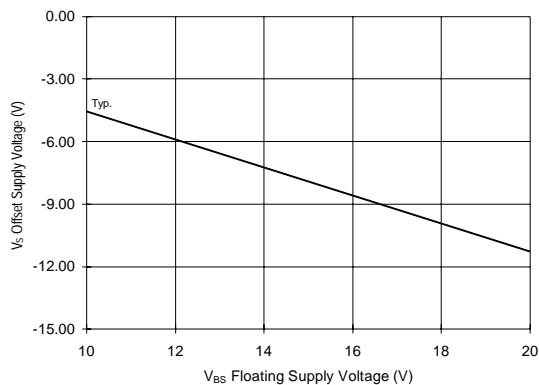

Figure 37. Maximum V<sub>S</sub> Negative Offset vs. Supply Voltage

International  
**IR** Rectifier

**WORLD HEADQUARTERS:** 233 Kansas St., El Segundo, California 90245 Tel: (310) 322 3331

**IR GREAT BRITAIN:** Hurst Green, Oxted, Surrey RH8 9BB, UK Tel: ++ 44 1883 732020

**IR CANADA:** 15 Lincoln Court, Brampton, Ontario L6T 3Z2 Tel: (905) 453-2200

**IR GERMANY:** Saalburgstrasse 157, 61350 Bad Homburg Tel: ++ 49 6172 96590

**IR ITALY:** Via Liguria 49, 10071 Borgaro, Torino Tel: ++ 39 11 451 0111

**IR FAR EAST:** K&H Bldg., 2F, 30-4 Nishi-Ikebukuro 3-Chome, Toshima-Ku, Tokyo, Japan 171 Tel: 81 3 3983 0086

**IR SOUTHEAST ASIA:** 1 Kim Seng Promenade, Great World City West Tower, 13-11, Singapore 237994 Tel: 65 838 4630

**IR TAIWAN:** 16 Fl. Suite D..207, Sec.2, Tun Haw South Road, Taipei, 10673, Taiwan Tel: 886-2-2377-9936

<http://www.irf.com/>

Data and specifications subject to change without notice. 11/98