



4 x 45W QUAD BRIDGE CAR RADIO AMPLIFIER PLUS HSD

- SUPERIOR OUTPUT POWER CAPABILITY:
 - 4 x 50W/4Ω MAX.
 - 4 x 45W/4Ω EIAJ
 - 4 x 30W/4Ω @ 14.4V, 1KHz, 10%
 - 4 x 80W/2Ω MAX.
 - 4 x 77W/2Ω EIAJ
 - 4 x 55W/2Ω @ 14.4V, 1KHz, 10%
- EXCELLENT 2Ω DRIVING CAPABILITY
- HI-FI CLASS DISTORTION
- LOW OUTPUT NOISE
- ST-BY FUNCTION
- MUTE FUNCTION
- AUTOMUTE AT MIN. SUPPLY VOLTAGE DETECTION
- LOW EXTERNAL COMPONENT COUNT:
 - INTERNALLY FIXED GAIN (26dB)
 - NO EXTERNAL COMPENSATION
 - NO BOOTSTRAP CAPACITORS
- ON BOARD 0.35A HIGH SIDE DRIVER

PROTECTIONS:

- OUTPUT SHORT CIRCUIT TO GND, TO V_S , ACROSS THE LOAD
- VERY INDUCTIVE LOADS
- OVERRATING CHIP TEMPERATURE WITH SOFT THERMAL LIMITER
- OUTPUT DC OFFSET DETECTION

BLOCK AND APPLICATION DIAGRAM

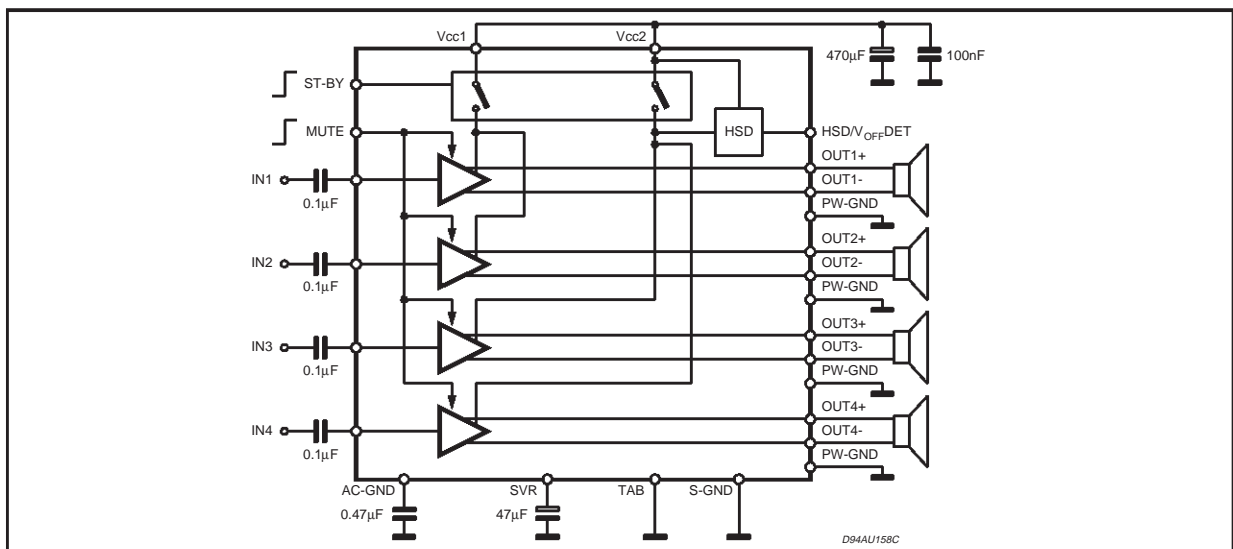

MULTIPOWER BCD TECHNOLOGY

MOSFET OUTPUT POWER STAGE

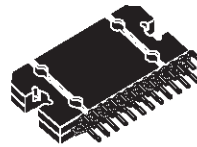

FLEXIWATT25

ORDERING NUMBER: TDA7560

- LOAD DUMP VOLTAGE
- FORTUITOUS OPEN GND
- REVERSED BATTERY
- ESD

DESCRIPTION

The TDA7560 is a breakthrough BCD (Bipolar / CMOS / DMOS) technology class AB Audio Power Amplifier in Flexiwatt 25 package designed for high power car radio. The fully complementary P-Channel/N-Channel output structure allows a rail to rail output voltage swing which, combined with high output current and minimised saturation losses sets new power references in the car-radio field, with unparalleled distortion performances.

TDA7560

ABSOLUTE MAXIMUM RATINGS

| Symbol | Parameter | Value | Unit |
|--------------|---|-------------|--------|
| V_{CC} | Operating Supply Voltage | 18 | V |
| $V_{CC(DC)}$ | DC Supply Voltage | 28 | V |
| $V_{CC(pk)}$ | Peak Supply Voltage (t = 50ms) | 50 | V |
| I_o | Output Peak Current: Repetitive (Duty Cycle 10% at f = 10Hz) Non Repetitive (t = 100 μ s) | 9 10 | A A |
| P_{tot} | Power dissipation, (T _{case} = 70°C) | 80 | W |
| T_j | Junction Temperature | 150 | °C |
| T_{stg} | Storage Temperature | - 55 to 150 | °C |

PIN CONNECTION (Top view)

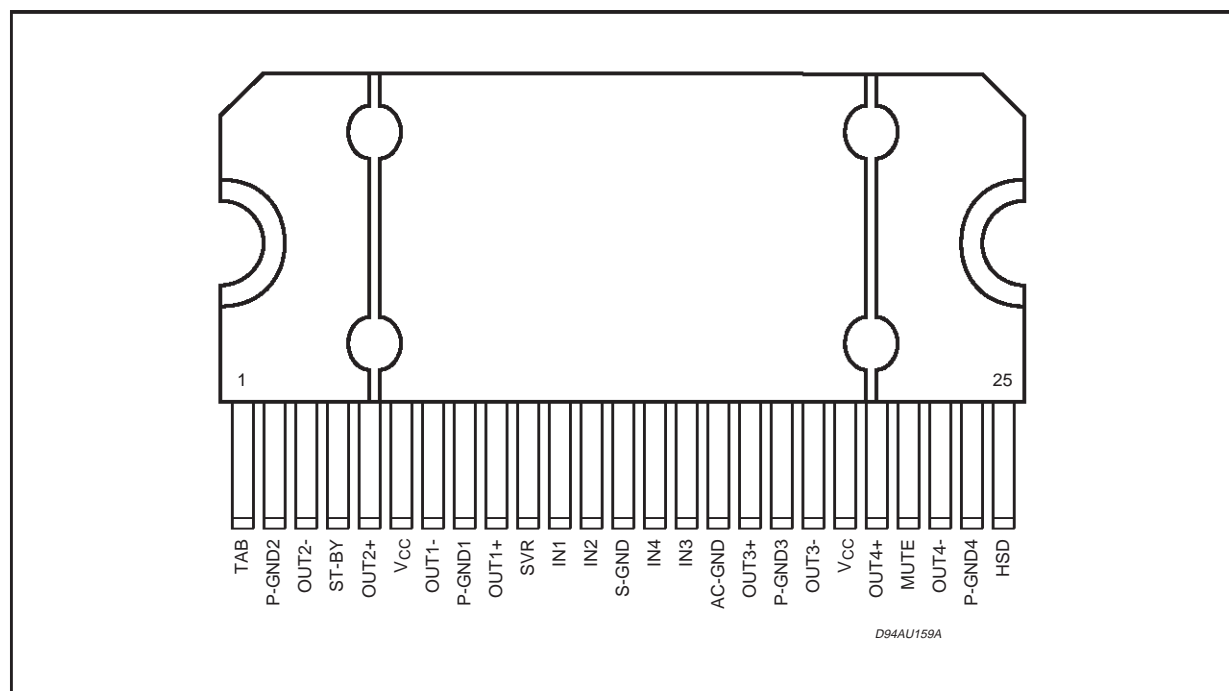

THERMAL DATA

| Symbol | Parameter | Value | Unit |
|-----------------|-------------------------------------|--------|------|
| $R_{th j-case}$ | Thermal Resistance Junction to Case | Max. 1 | °C/W |

ELECTRICAL CHARACTERISTICS ($V_S = 13.2V$; $f = 1KHz$; $R_g = 600\Omega$; $R_L = 4\Omega$; $T_{amb} = 25^\circ C$;
Refer to the test and application diagram, unless otherwise specified.)

| Symbol | Parameter | Test Condition | Min. | Typ. | Max. | Unit |
|--------------------------------|--|---|---------|---------|----------|------------|
| I_{q1} | Quiescent Current | $R_L = \infty$ | 120 | 200 | 320 | mA |
| V_{OS} | Output Offset Voltage | Play Mode | | | ± 60 | mV |
| dV_{OS} | During mute ON/OFF output offset voltage | | | | ± 60 | mV |
| G_v | Voltage Gain | | 25 | 26 | 27 | dB |
| dG_v | Channel Gain Unbalance | | | | ± 1 | dB |
| P_o | Output Power | $V_S = 13.2V$; THD = 10% | 23 | 25 | | W |
| | | $V_S = 13.2V$; THD = 1% | 16 | 19 | | W |
| | | $V_S = 14.4V$; THD = 10% | 28 | 30 | | W |
| | | $V_S = 14.4V$; THD = 1% | 20 | 23 | | W |
| | | $V_S = 13.2V$; THD = 10%, 2Ω | 42 | 45 | | W |
| | | $V_S = 13.2V$; THD = 1%, 2Ω | 32 | 34 | | W |
| | | $V_S = 14.4V$; THD = 10%, 2Ω | 50 | 55 | | W |
| | | $V_S = 14.4V$; THD = 1%, 2Ω | 40 | 43 | | W |
| P_o EIAJ | EIAJ Output Power (*) | $V_S = 13.7V$; $R_L = 4\Omega$ | 41 | 45 | | W |
| | | $V_S = 13.7V$; $R_L = 2\Omega$ | | 77 | | W |
| P_o max. | Max. Output Power (*) | $V_S = 14.4V$; $R_L = 4\Omega$ | | 50 | | W |
| | | $V_S = 14.4V$; $R_L = 2\Omega$ | | 80 | | W |
| THD | Distortion | $P_o = 4W$ | | 0.006 | 0.05 | % |
| | | $P_o = 15W$; $R_L = 2\Omega$ | | 0.015 | 0.07 | % |
| e_{No} | Output Noise | "A" Weighted Bw = 20Hz to 20KHz | | 35 | 50 | μV |
| | | | | | 50 | 70 |
| SVR | Supply Voltage Rejection | $f = 100Hz$; $V_r = 1V_{rms}$ | 50 | 70 | | dB |
| f_{ch} | High Cut-Off Frequency | $P_o = 0.5W$ | 100 | 300 | | KHz |
| R_i | Input Impedance | | 80 | 100 | 120 | K Ω |
| C_T | Cross Talk | $f = 1KHz$ $P_o = 4W$ | 60 | 70 | - | dB |
| | | $f = 10KHz$ $P_o = 4W$ | | 60 | - | dB |
| I_{SB} | St-By Current Consumption | $V_{St-By} = 1.5V$ | | | 75 | μA |
| I_{pin4} | St-by pin Current | $V_{St-By} = 1.5V$ to $3.5V$ | | | ± 10 | μA |
| $V_{SB\ out}$ | St-By Out Threshold Voltage | (Amp: ON) | 3.5 | | | V |
| $V_{SB\ in}$ | St-By in Threshold Voltage | (Amp: OFF) | | | 1.5 | V |
| A_M | Mute Attenuation | $P_{Oref} = 4W$ | 80 | 90 | | dB |
| $V_{M\ out}$ | Mute Out Threshold Voltage | (Amp: Play) | 3.5 | | | V |
| $V_{M\ in}$ | Mute In Threshold Voltage | (Amp: Mute) | | | 1.5 | V |
| $V_{AM\ in}$ | V_S Automute Threshold | (Amp: Mute) Att $\geq 80dB$; $P_{Oref} = 4W$ | 6.5 | 7 | | V |
| | | (Amp: Play) Att $< 0.1dB$; $P_o = 0.5W$ | | 7.5 | 8 | V |
| I_{pin22} | Muting Pin Current | $V_{MUTE} = 1.5V$ (Sourced Current) | 7 | 12 | 18 | μA |
| | | $V_{MUTE} = 3.5V$ | -5 | | 18 | μA |
| HSD SECTION | | | | | | |
| $V_{dropout}$ | Dropout Voltage | $I_o = 0.35A$; $V_S = 9$ to $16V$ | | 0.25 | 0.6 | V |
| I_{prot} | Current Limits | | 400 | | 800 | mA |
| OFFSET DETECTOR SECTION | | | | | | |
| $V_{M\ ON}$ | Mute Voltage for DC offset detection enabled | $V_{stby} = 5V$ | 8 | | | V |
| $V_{M\ OFF}$ | | | | | 6 | V |
| V_{OFF} | Detected Differential Output Offset | $V_{stby} = 5V$; $V_{mute} = 8V$ | ± 2 | ± 3 | ± 4 | V |
| V_{25_T} | Pin 25 Voltage for Detection = TRUE | $V_{stby} = 5V$; $V_{mute} = 8V$ $V_{OFF} > \pm 4V$ | 0 | | 1.5 | V |
| V_{25_F} | Pin 25 Voltage for Detection = FALSE | $V_{stby} = 5V$; $V_{mute} = 8V$ $V_{OFF} > \pm 2V$ | 12 | | | V |

(*) Saturated square wave output.

Figure 1: Standard Test and Application Circuit

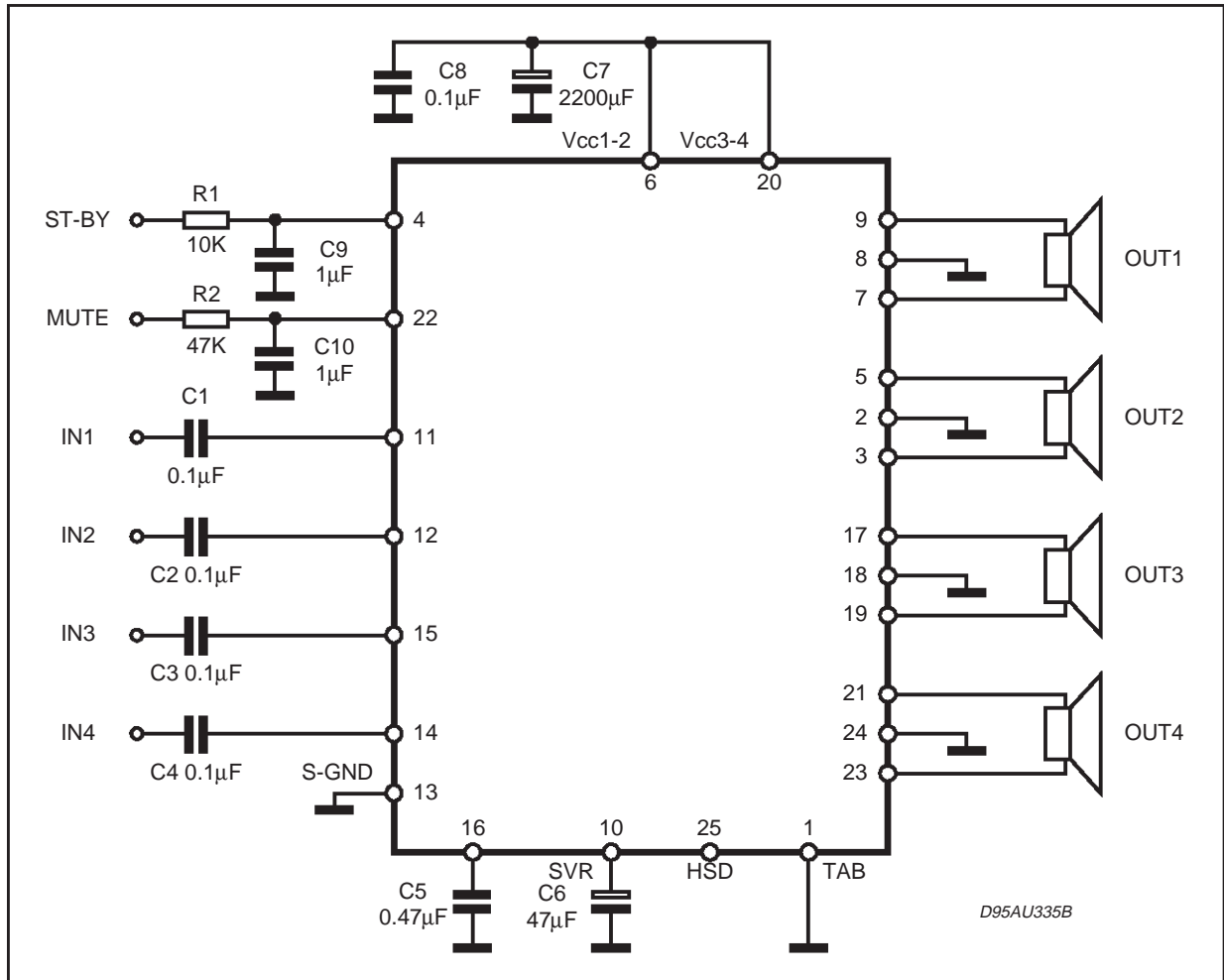

Figure 2: P.C.B. and component layout of the figure 1 (1:1 scale)

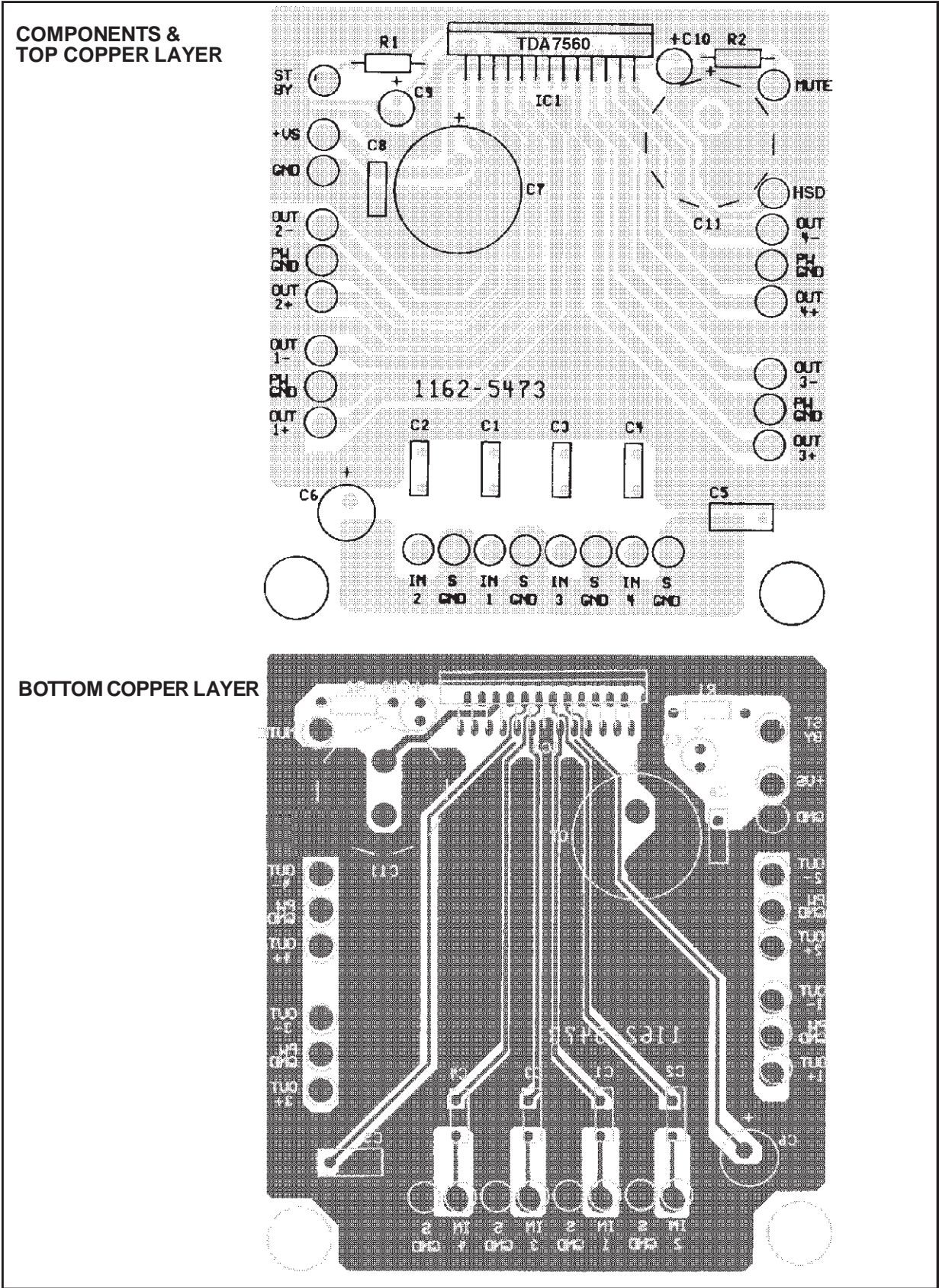

Figure 3. Quiescent current vs. supply voltage.

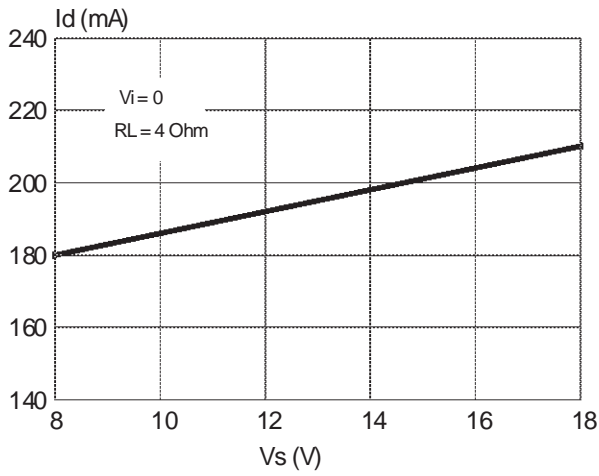

Figure 4. Output power vs. supply voltage.

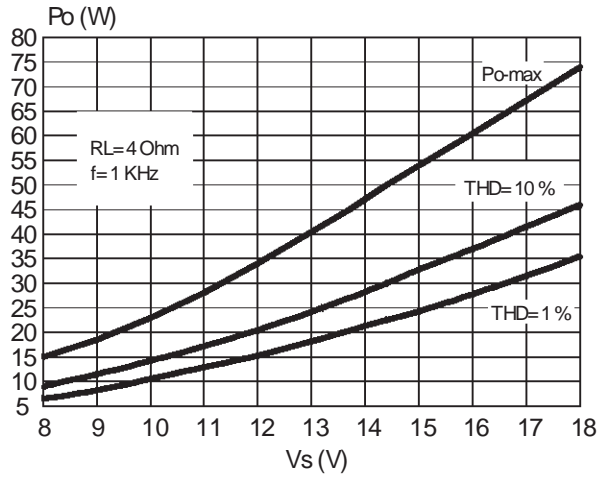

Figure 5. Output power vs. supply voltage.

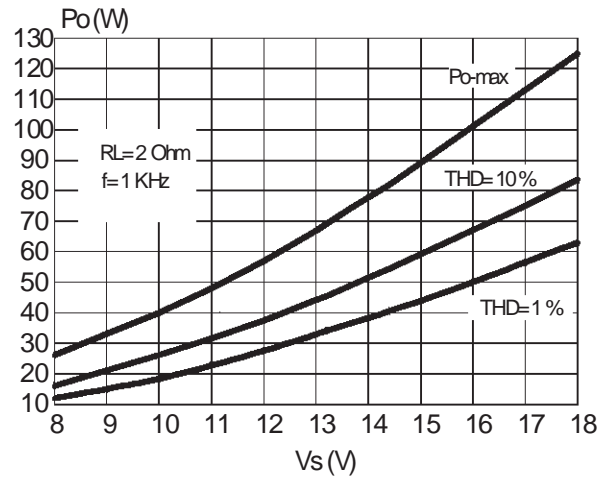

Figure 6. Distortion vs. output Power

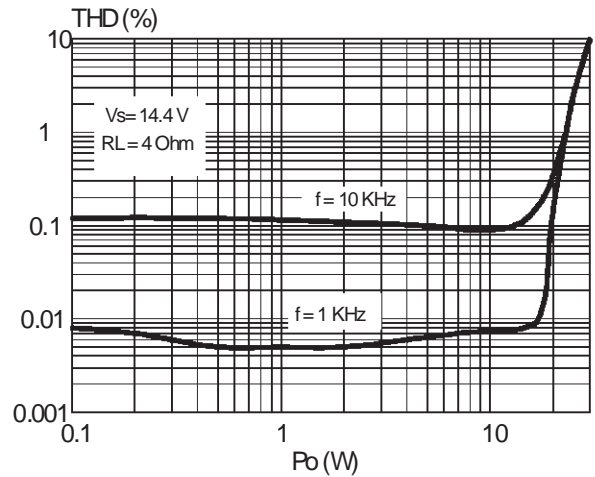

Figure 7. Distortion vs. output power

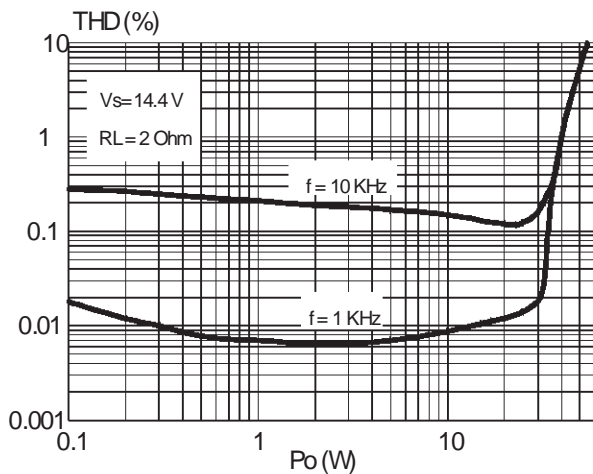

Figure 8. Distortion vs. frequency.

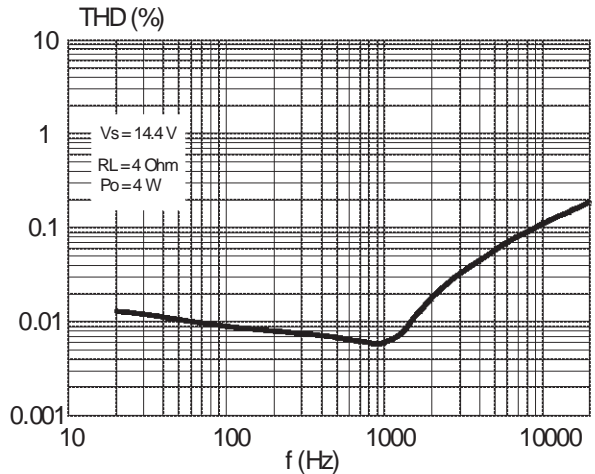

Figure 9. Distortion vs. frequency.

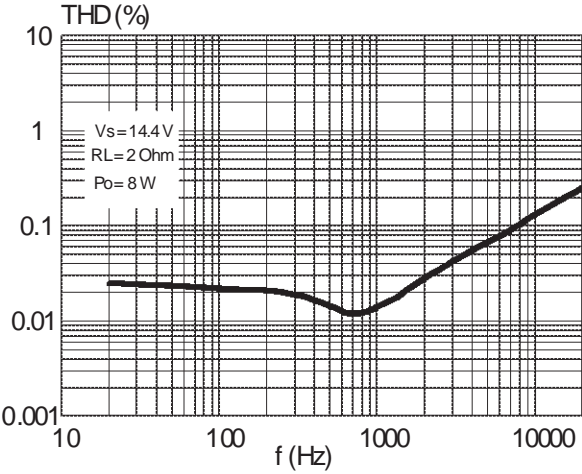

Figure 10. Crosstalk vs. frequency.

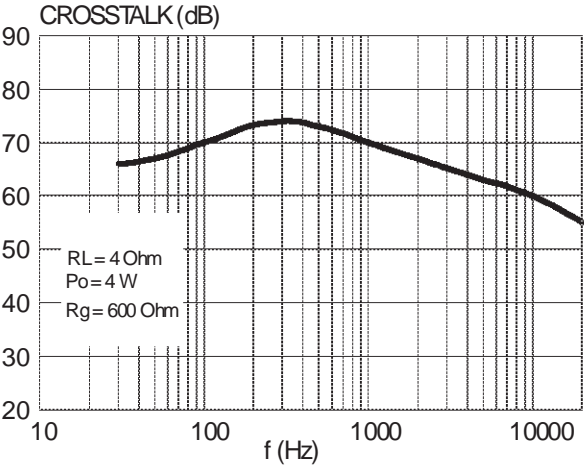

Figure 11. Supply voltage rejection vs. frequency.

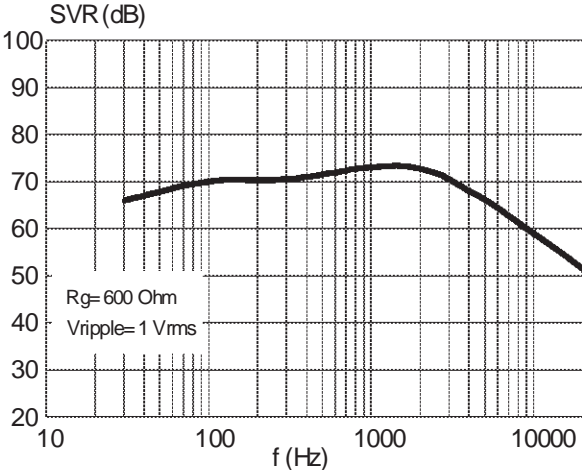

Figure 12. Output attenuation vs. supply voltage.

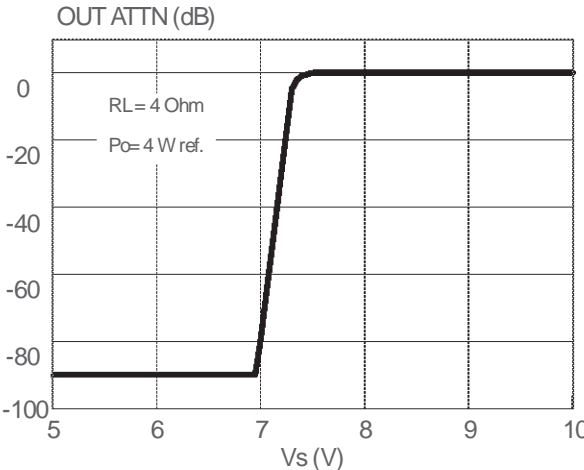

Figure 13. Output noise vs. source resistance.

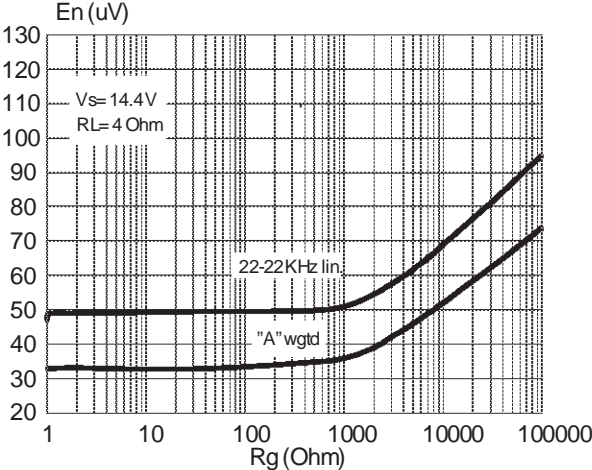

Figure 14. Power dissipation & efficiency vs. output power (sine-wave operation)

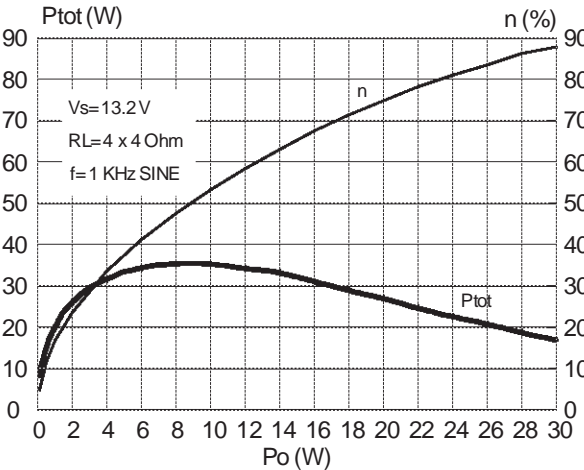

Figure 15. Power dissipation vs. output power (Music/Speech Simulation)

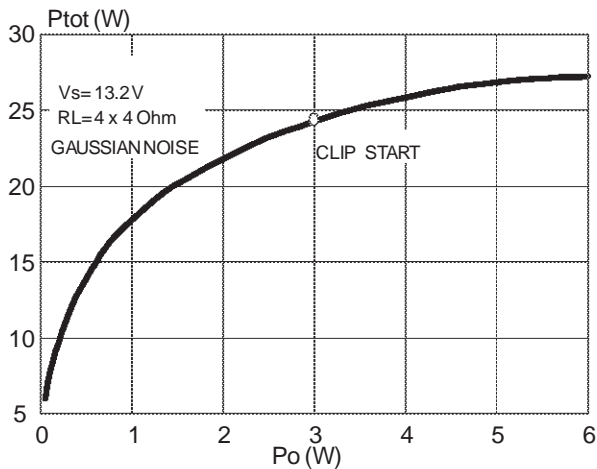
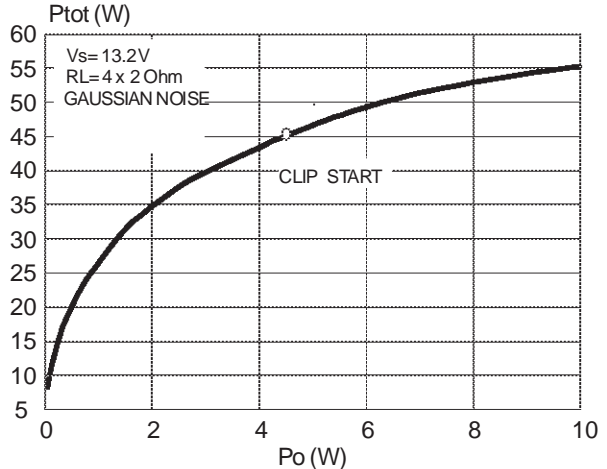

Figure 16. Power dissipation vs. output power (Music/Speech Simulation)



DC OFFSET DETECTOR

The TDA7560 integrates a DC offset detector to avoid that an anomalous DC offset on the inputs of the amplifier may be multiplied by the gain and result in a dangerous large offset on the outputs which may lead to speakers damage for overheating.

The feature is enabled by the MUTE pin and works with the amplifier unmuted and with no signal on the inputs. The DC offset detection is signaled out on the HSD pin.

APPLICATION HINTS (ref. to the circuit of fig. 1)

SVR

Besides its contribution to the ripple rejection, the SVR capacitor governs the turn ON/OFF time sequence and, consequently, plays an essential role in the pop optimization during ON/OFF transients. To conveniently serve both needs, **ITS MINIMUM RECOMMENDED VALUE IS 10µF.**

INPUT STAGE

The TDA7560's inputs are ground-compatible and can stand very high input signals ($\pm 8V_{pk}$) without any performances degradation.

If the standard value for the input capacitors (0.1µF) is adopted, the low frequency cut-off will amount to 16 Hz.

STAND-BY AND MUTING

STAND-BY and MUTING facilities are both CMOS-COMPATIBLE. If unused, a straight connection to Vs of their respective pins would be admissible. Conventional low-power transistors can be employed to drive muting and stand-by pins in absence of true CMOS ports or microprocessors.

R-C cells have always to be used in order to smooth down the transitions for preventing any audible transient noises.

About the stand-by, the time constant to be assigned in order to obtain a virtually pop-free transition has to be slower than 2.5V/ms.

HEATSINK DEFINITION

Under normal usage (4 Ohm speakers) the heatsink's thermal requirements have to be deduced from fig. 15, which reports the simulated power dissipation when real music/speech programmes are played out. Noise with gaussian-distributed amplitude was employed for this simulation. Based on that, frequent clipping occurrence (worst-case) will cause $P_{diss} = 26W$. Assuming $T_{amb} = 70^{\circ}C$ and $T_{CHIP} = 150^{\circ}C$ as boundary conditions, the heatsink's thermal resistance should be approximately $2^{\circ}C/W$. This would avoid any thermal shutdown occurrence even after long-term and full-volume operation.

| DIM. | mm | | | inch | | |
|--------|-------|-------|-------|-------|------------|-------|
| | MIN. | TYP. | MAX. | MIN. | TYP. | MAX. |
| A | 4.45 | 4.50 | 4.65 | 0.175 | 0.177 | 0.183 |
| B | 1.80 | 1.90 | 2.00 | 0.070 | 0.074 | 0.079 |
| C | | 1.40 | | | 0.055 | |
| D | 0.75 | 0.90 | 1.05 | 0.029 | 0.035 | 0.041 |
| E | 0.37 | 0.39 | 0.42 | 0.014 | 0.015 | 0.016 |
| F (1) | | | 0.57 | | | 0.022 |
| G | 0.80 | 1.00 | 1.20 | 0.031 | 0.040 | 0.047 |
| G1 | 23.75 | 24.00 | 24.25 | 0.935 | 0.945 | 0.955 |
| H (2) | 28.90 | 29.23 | 29.30 | 1.138 | 1.150 | 1.153 |
| H1 | | 17.00 | | | 0.669 | |
| H2 | | 12.80 | | | 0.503 | |
| H3 | | 0.80 | | | 0.031 | |
| L (2) | 22.07 | 22.47 | 22.87 | 0.869 | 0.884 | 0.904 |
| L1 | 18.57 | 18.97 | 19.37 | 0.731 | 0.747 | 0.762 |
| L2 (2) | 15.50 | 15.70 | 15.90 | 0.610 | 0.618 | 0.626 |
| L3 | 7.70 | 7.85 | 7.95 | 0.303 | 0.309 | 0.313 |
| L4 | | 5 | | | 0.197 | |
| L5 | | 3.5 | | | 0.138 | |
| M | 3.70 | 4.00 | 4.30 | 0.145 | 0.157 | 0.169 |
| M1 | 3.60 | 4.00 | 4.40 | 0.142 | 0.157 | 0.173 |
| N | | 2.20 | | | 0.086 | |
| O | | 2 | | | 0.079 | |
| R | | 1.70 | | | 0.067 | |
| R1 | | 0.5 | | | 0.02 | |
| R2 | | 0.3 | | | 0.12 | |
| R3 | | 1.25 | | | 0.049 | |
| R4 | | 0.50 | | | 0.019 | |
| V | | | | | 5° (Typ.) | |
| V1 | | | | | 3° (Typ.) | |
| V2 | | | | | 20° (Typ.) | |
| V3 | | | | | 45° (Typ.) | |

OUTLINE AND MECHANICAL DATA

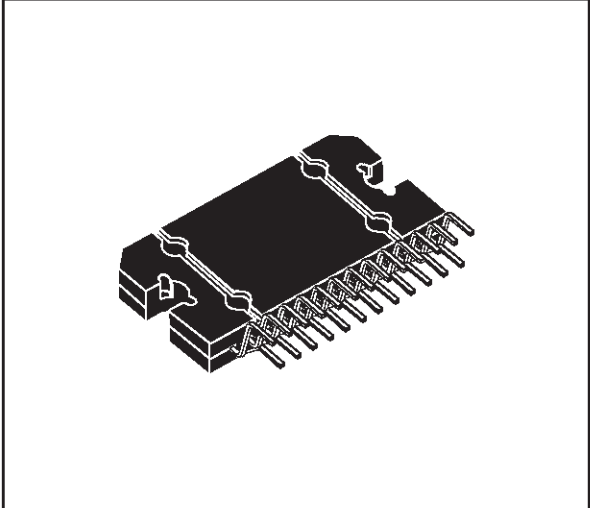

Flexiwatt25

(1): dam-bar protusion not included
 (2): molding protusion included

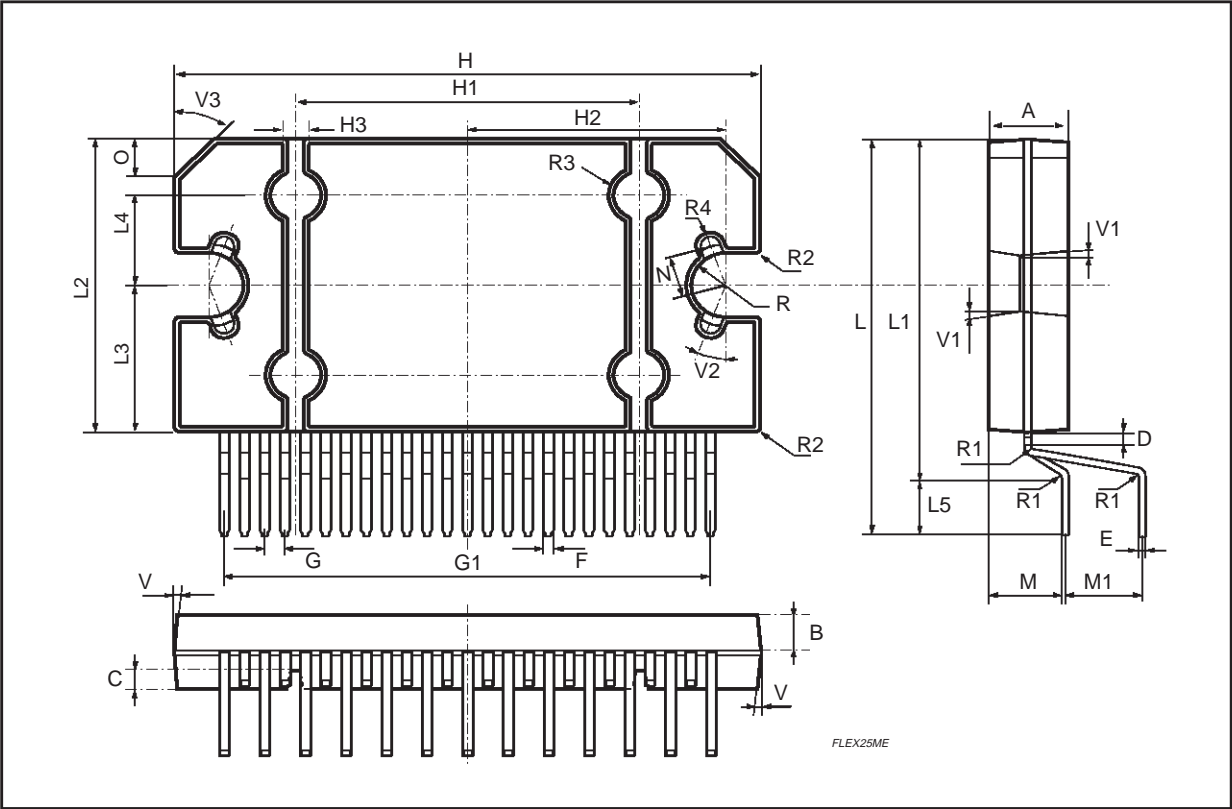

Information furnished is believed to be accurate and reliable. However, STMicroelectronics assumes no responsibility for the consequences of use of such information nor for any infringement of patents or other rights of third parties which may result from its use. No license is granted by implication or otherwise under any patent or patent rights of STMicroelectronics. Specification mentioned in this publication are subject to change without notice. This publication supersedes and replaces all information previously supplied. STMicroelectronics products are not authorized for use as critical components in life support devices or systems without express written approval of STMicroelectronics.

The ST logo is a registered trademark of STMicroelectronics

© 2001 STMicroelectronics – Printed in Italy – All Rights Reserved

STMicroelectronics GROUP OF COMPANIES

Australia - Brazil - Canada - China - Finland - France - Germany - Hong Kong - India - Israel - Italy - Japan - Malaysia - Malta - Morocco - Singapore - Spain - Sweden - Switzerland - United Kingdom - United States.

<http://www.st.com>