

### TX synthesizer

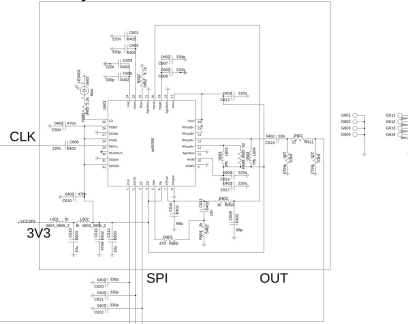

### Directional Coupler

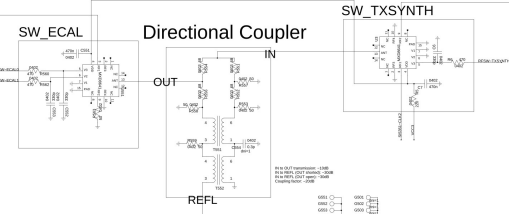

### SW\_TXSYNTH

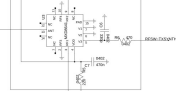

### SW\_REFL



### SW\_REC



### Mixer

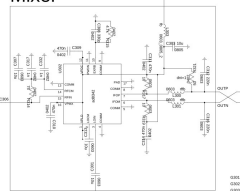

### BB amplifier

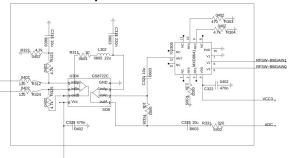

### Power management

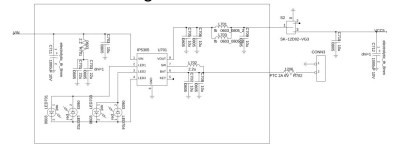

### 3.3V L4 buck converter

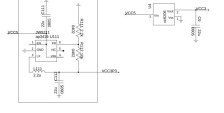

### RX synthesizer

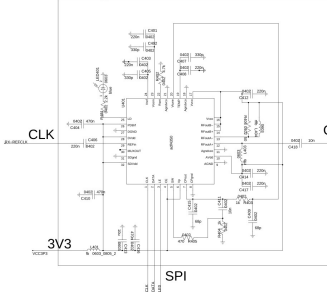

### SW\_RXSYNTH

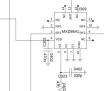

### si5351

