

MA2820

OUTLINE DIMENSIONS

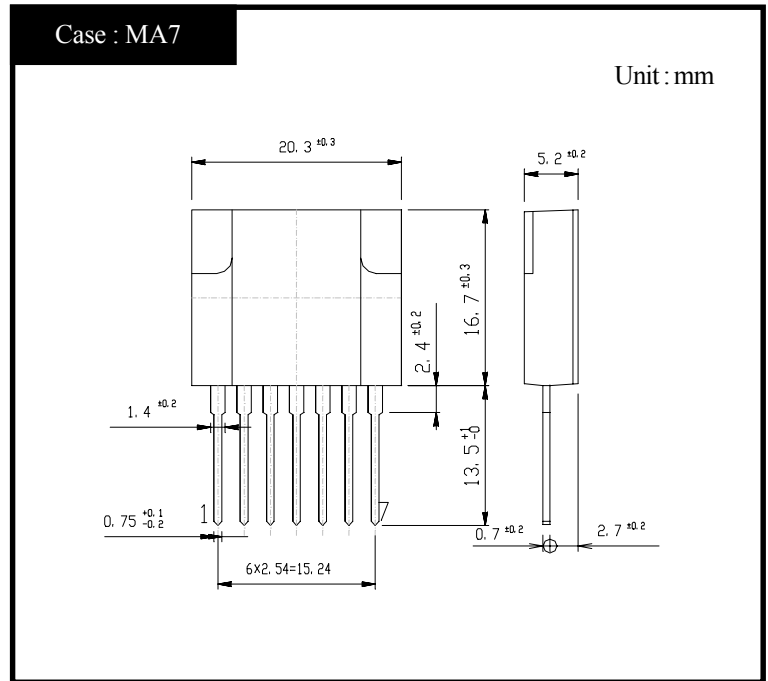

RATINGS

Absolute Maximum Ratings

Item	Symbol	Conditions	Ratings		Unit
			P Class	N Class	
Storage Temperature	T _{stg}		-30~125	-30~125	°C
Operating Temperature	T _{op}	Case Temperature	-20~125	-20~125	°C
Junction Temperature	T _j		150	150	°C
Peak Input Voltage	V _{in}	②+,④-, Fig.1 is Measurement Circuit of Peak Input Voltage V _{in} and Collector Cutoff Current I _{CEX} .	850	850	V
Input Current	I _{in}	Pulse Pulse Width 150 μs MAX, Duty 1/2, Sawtooth Wave, Peak Value, ②+,④-	6	6	A
Maximum Operating Frequency	f(max)		200	200	kHz
Maximum Power Dissipation	P _D	T _a =25°C	3	3	W
		Heatsink T _c =100°C	20	20	W
Dielectric Strength	V _{dis}	Terminals To Case AC 1 min	2	2	kV
Insulation Resistance		Terminals To Case 500VDC	100	100	MΩ
Fold Back Control Voltage	V _{CONT(max)}	Fold Control Resistance=0Ω Duty 1/2, ④,⑦	±8	±8	V
Fold Back Control Current	I _{CONT(max)}	④-,⑥+	100	100	mA

Electrical Characteristics (T_c=25°C)

Item	Symbol	Conditions	Ratings		Unit
			P Class	N Class	
Q1	Collector Cutoff Current	I _{CEX} V _{CE} =850V, Fig.1 is Measurement Circuit of Peak Input Voltage V _{in} and Collector Cutoff Current I _{CEX} , ②+,④-	MAX 0.1	MAX 0.1	mA
	DC Current Gain	h _{FE} V _{CE} = 5V, I _C = 1.5A, ②+,④-,⑤I _B	13~26	8~16	
	Collector to Emitter Saturation Voltage	V _{CE(sat)} I _C =1.5A, I _B =0.3A, ②+,④-,⑤I _B	MAX 1.0	MAX 1.0	V
	Thermal Resistance	θ _{jc} Junction to Case	MAX 2.5	MAX 2.5	°C/W
D1	Reverse Current	I _R V _R =800V,①+,②-	MAX 10	MAX 10	μA
	Forward Voltage	V _F I _F =0.6A,①-,②+	MAX 1.7	MAX 1.7	V
Driving Saturation Voltage	V _{D(sat)}	I _C =1.5A, I _B =0.3A, ⑤+,④-	MIN 1.7	MIN 1.7	V
			MAX 2.3	MAX 2.3	

● Standard Operating Condition • Design Standard For Application Circuit

Item	Conditions	Ratings		Unit
		P Class	N Class	
Input Rated Voltage		AC90~274	AC90~274	V
Output Nominal Wattage		24	24	W
Output Nominal Voltage		12	12	V
Output Nominal Current		2	2	A

● Standard Operating Condition • Standard Operating Characteristics (Ta=25°C)

Item	Conditions	Ratings		Unit		
		P Class	N Class			
Minimum Input Full Load Output Voltage	Vin=90V, IO=2A	12.0±0.6	12.0±0.6	V	Fig 2, ① Refer	
Maximum Input Light Load Output Voltage	Vin=274V, IO=0.2A	12.0±0.6	12.0±0.6	V	Fig 2, ② Refer	
AC Input Voltage	IO=2A	MAX 85	MAX 85	V		
Over Current Protection	Foldback Current	Vin=274V, VO=10V	MAX 3.5	MAX 3.5	A	Fig 2, ③ Refer
	Short Circuit	Vin=274V, RO=0.5Ω	Nodamage To Any Device, Automatic Recovery.		-	Fig 2, ④ Refer
Output Ripple Noise	Vin=90~274V, IO=0.2~2A	MAX 150	MAX 150	mV P-P		

Figure in ○=Terminal Sign

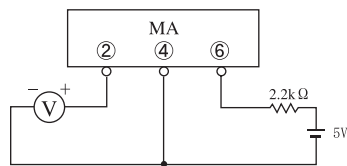

Fig1. Measurement Circuit

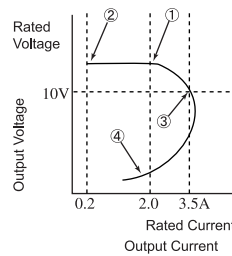
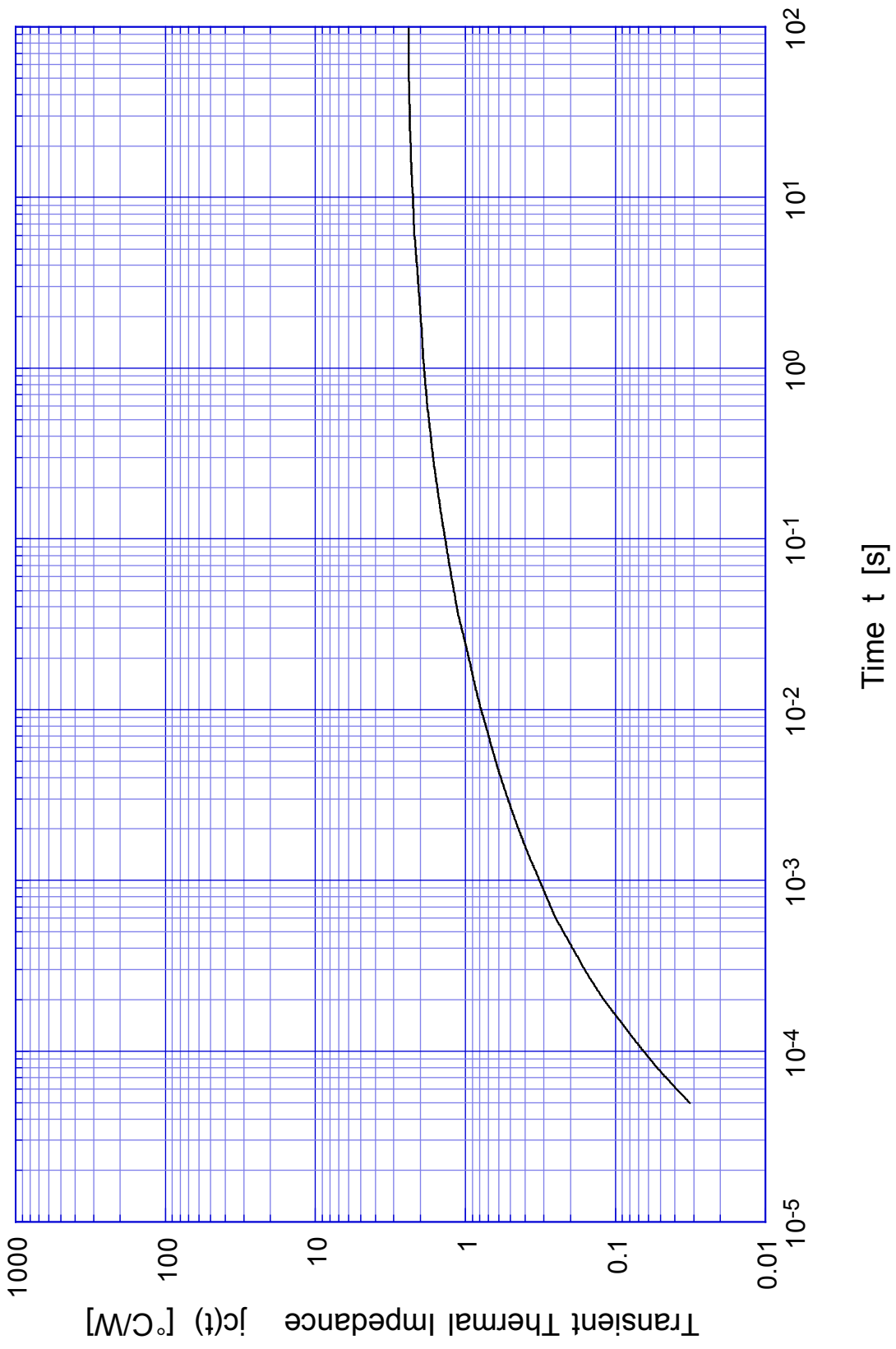

Fig2. Output Voltage/Current

MA2820 Transient Thermal Impedance



MA2820

Forward Bias SOA

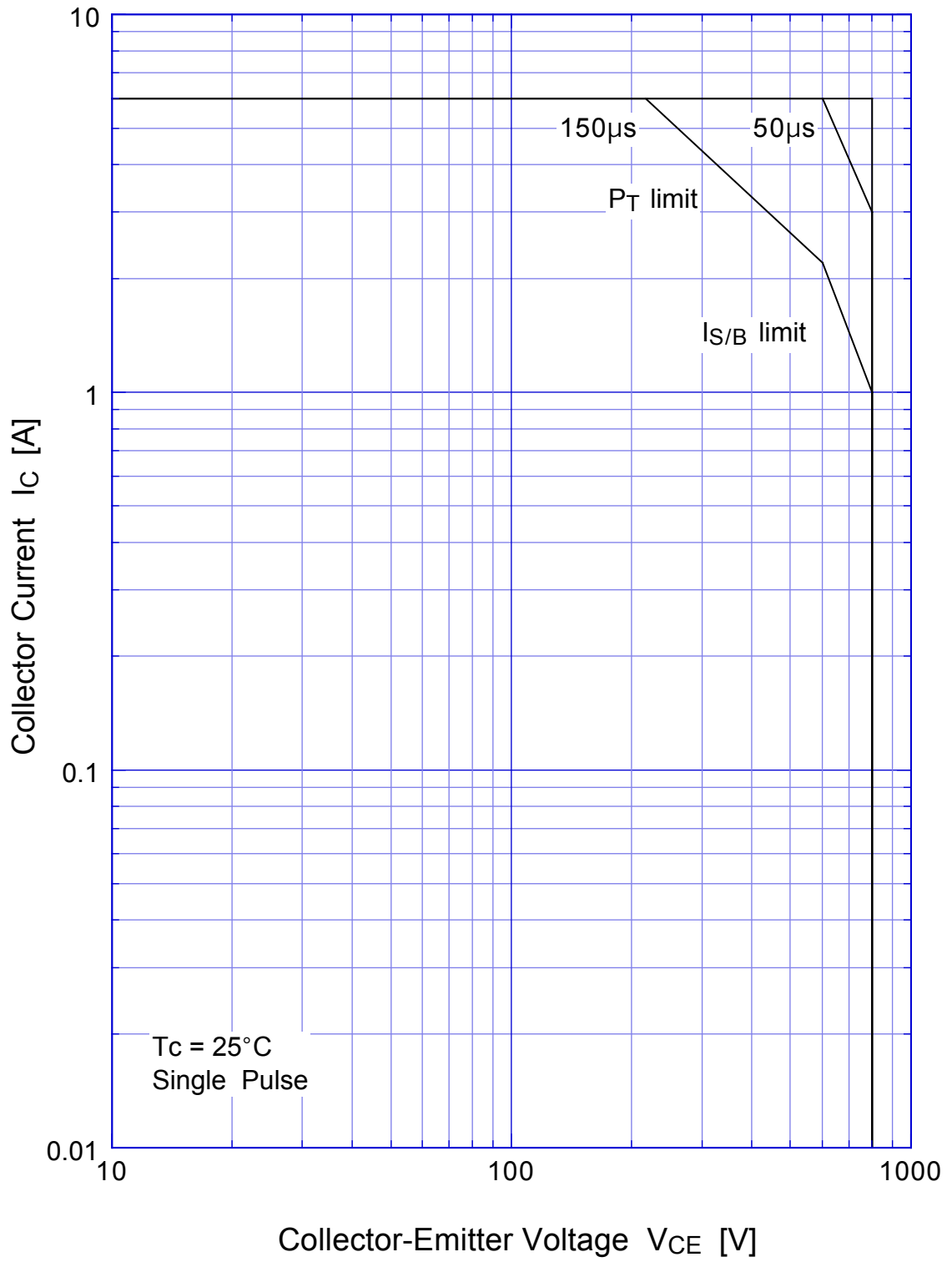

MA2820

Collector Current Derating

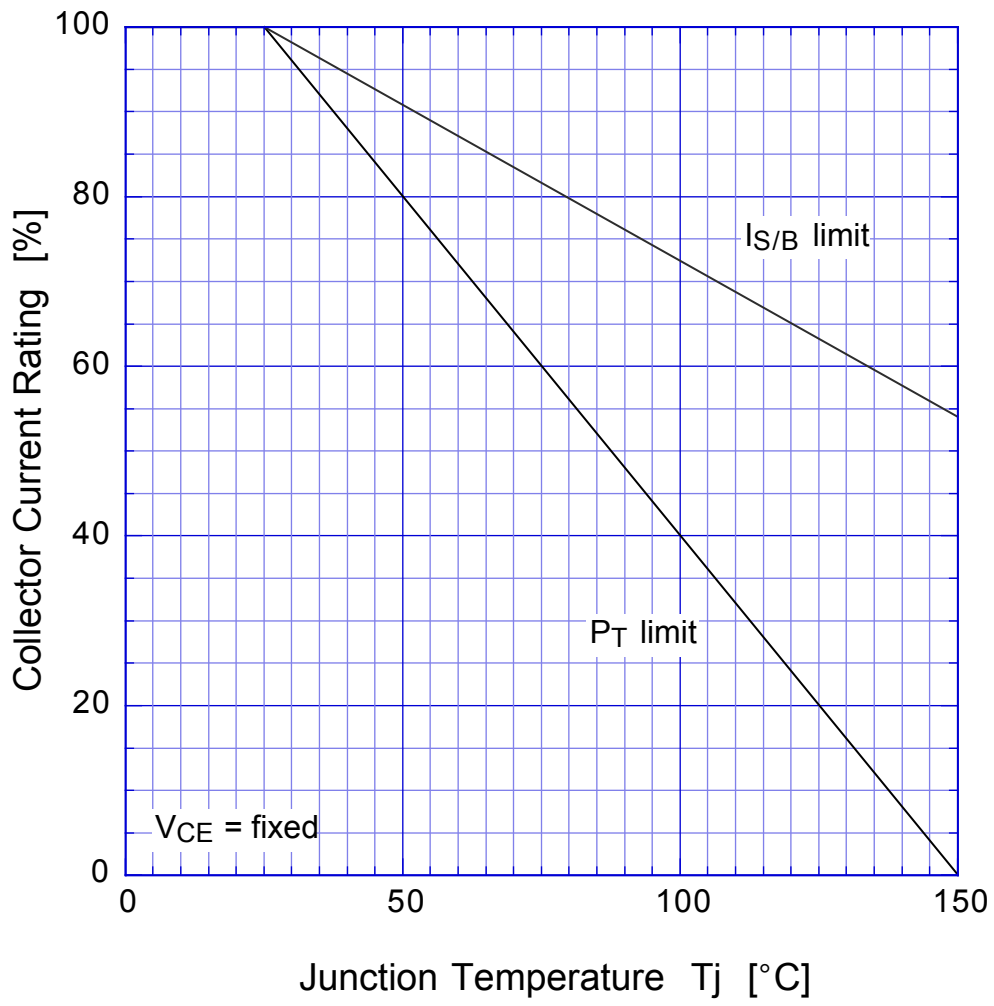

MA2820

Reverse Bias SOA

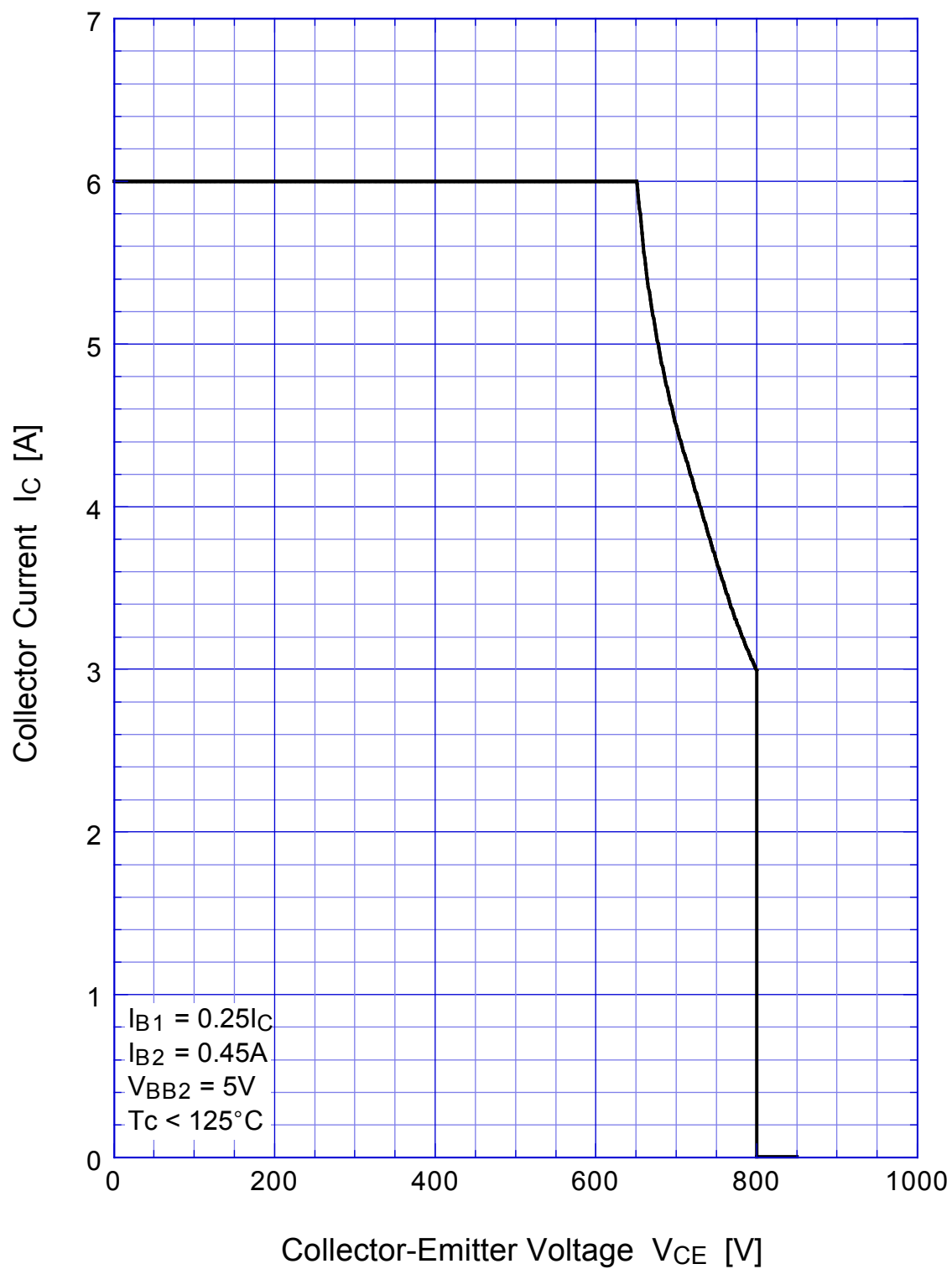

MA2820

$h_{FE} - I_C$

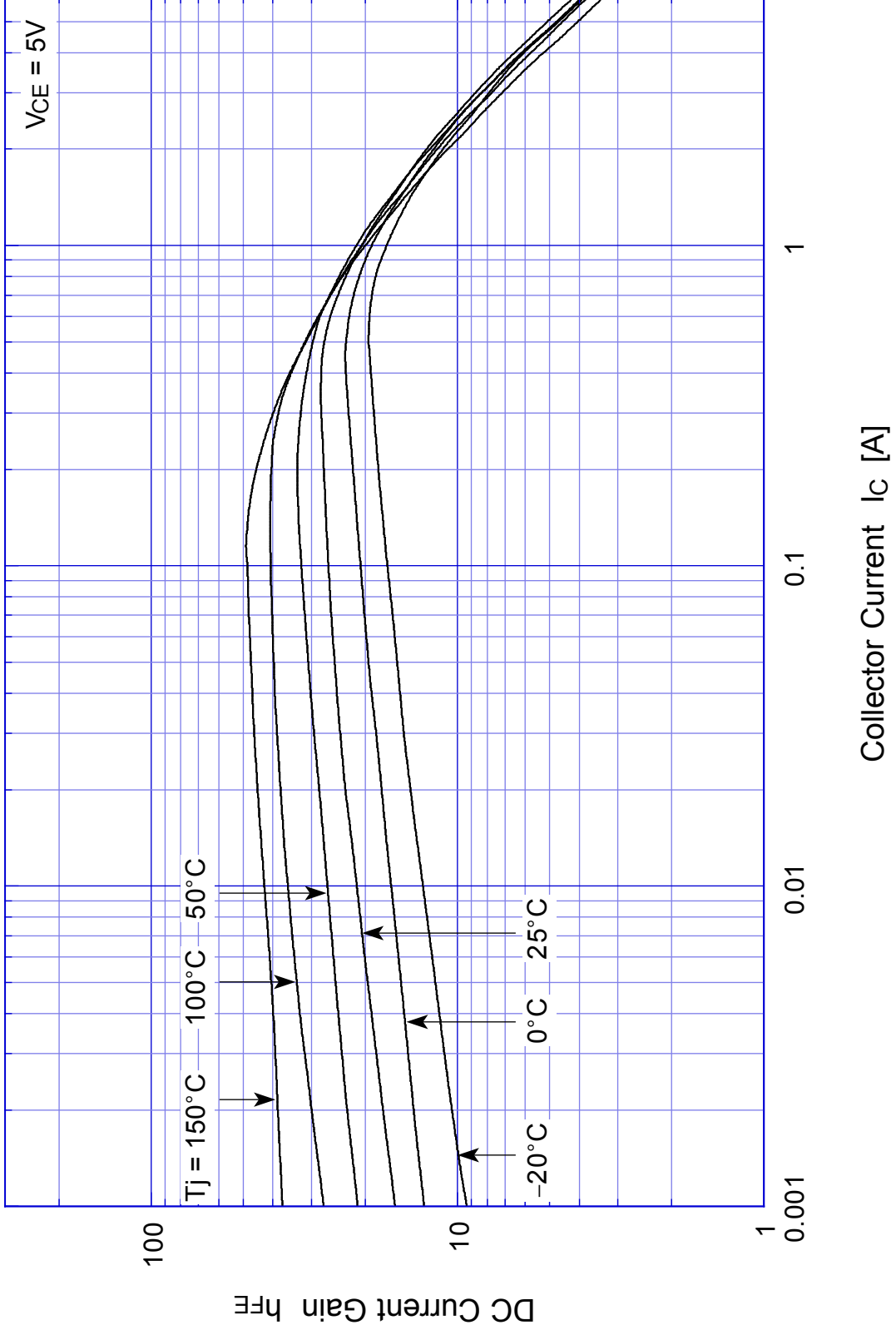

This datasheet has been download from:

www.datasheetcatalog.com

Datasheets for electronics components.