

PIC12F683 Worksheet

Toxic

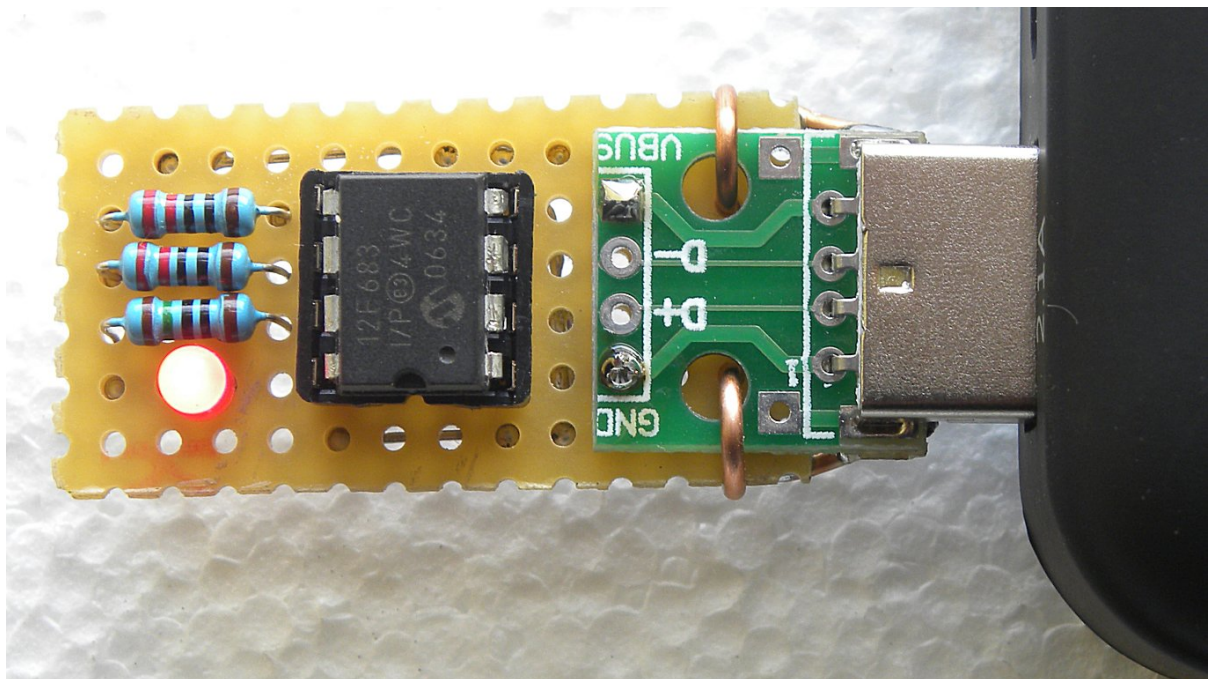

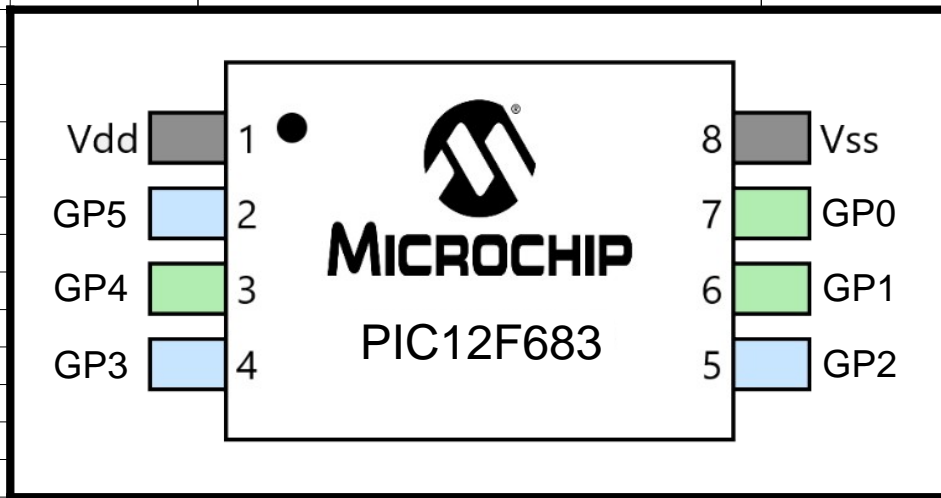
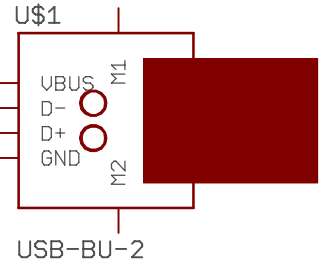
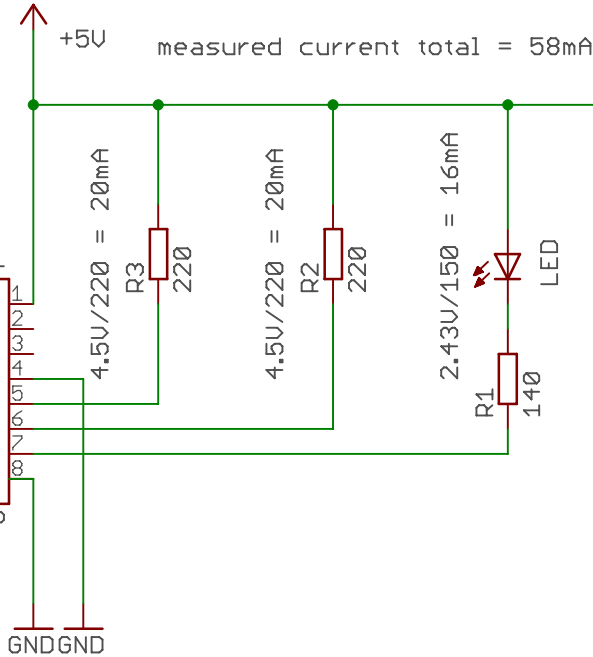
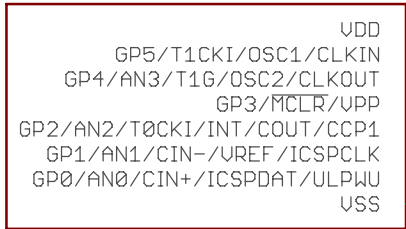

Powerbank

15/08/2020 16:52

Sheet: 1/1

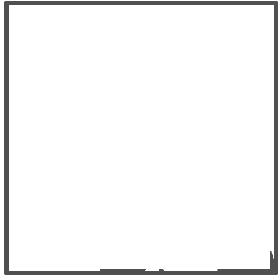
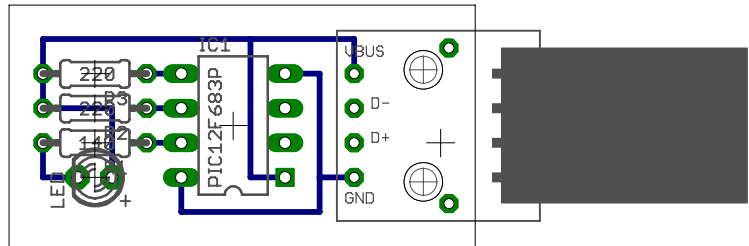

Powerbank

15/08/2020 16:52

Powerbank

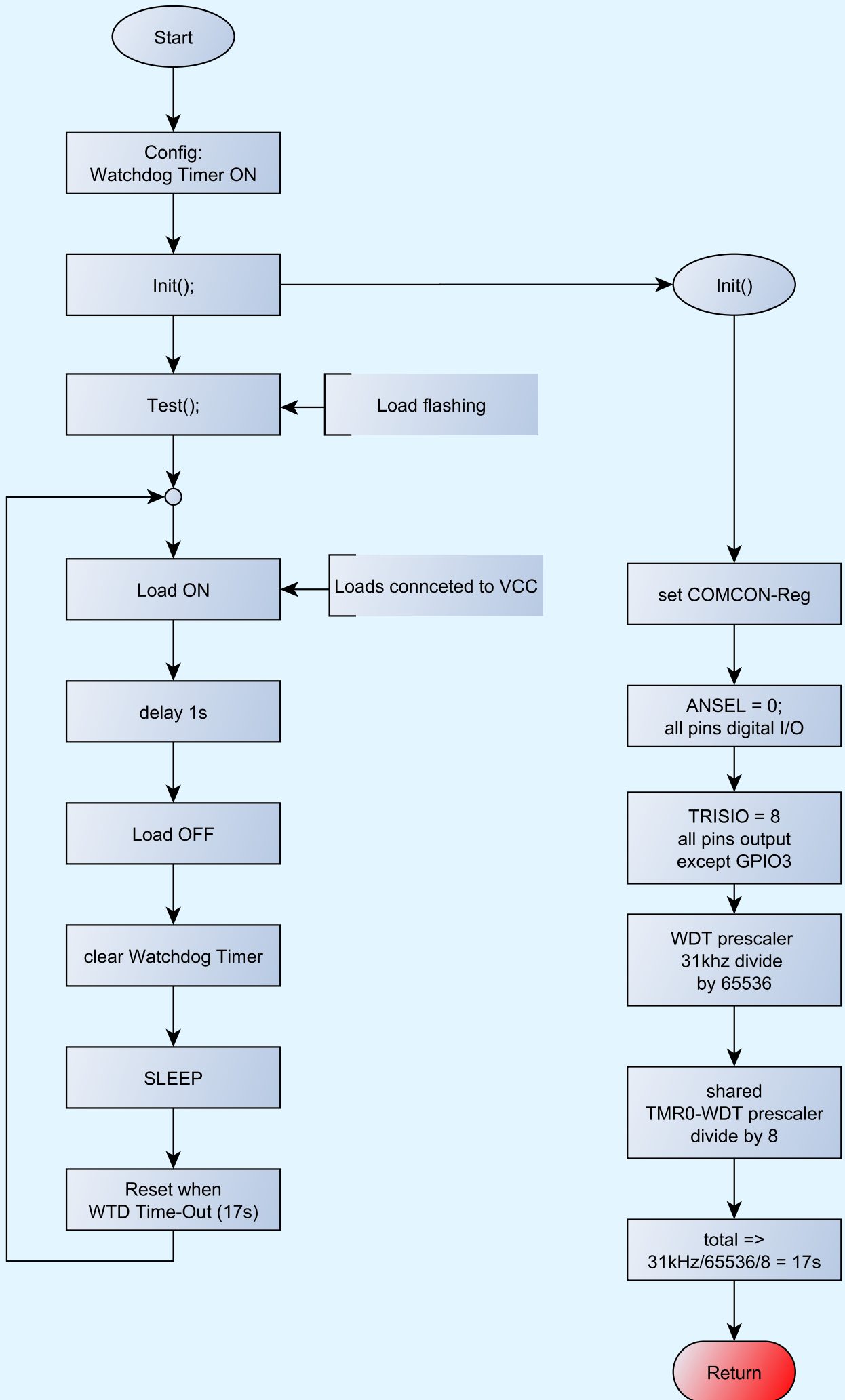

PIC12(L)F1840

FIGURE 31-41: V_{OH} vs. I_{OH} OVER TEMPERATURE, $V_{DD} = 5.5V$, PIC12F1840 ONLY

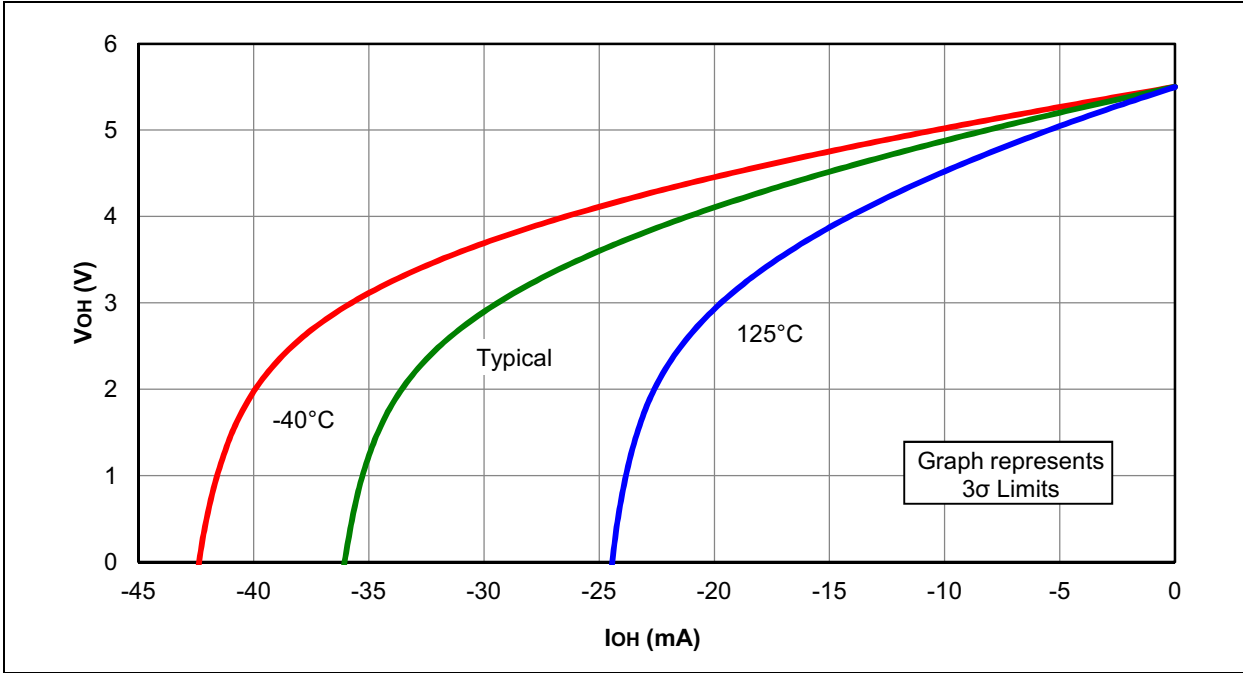

FIGURE 31-42: V_{OL} vs. I_{OL} OVER TEMPERATURE, $V_{DD} = 5.5V$, PIC12F1840 ONLY

