

"Schutzvermerk nach DIN ISO 16016 beachten." "Please pay attention to copyright note DIN ISO 16016"

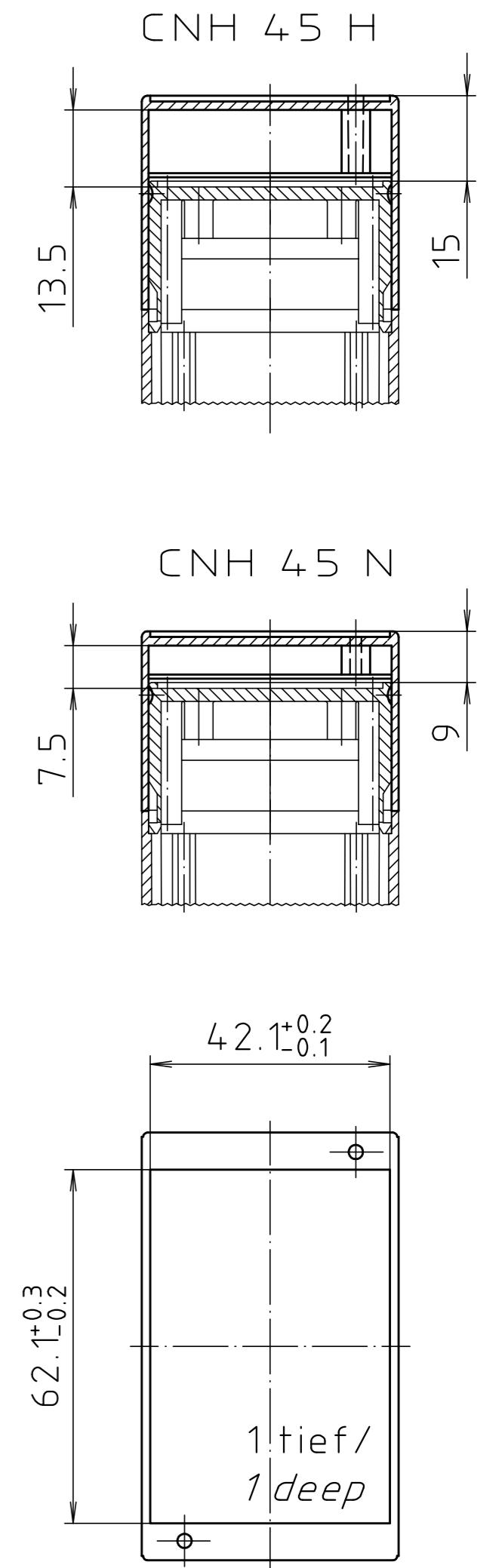

Maßstab/ Scale:	1:1	
Zeichnungs-Nr. / Drawing-No.:	2K 5180.044.04	
Artikel / Article:	CombiNorm CN(S) 45 AK Katalogzeichnung / Catalogue drawing	
A.Nr./ Alt-No.:	Datum/ Date:	
3626	20.08.02	
3137	08.02.95	
3056	26.09.94	
DISK: 2 601 169		
Datum/Date: 16.03.94 HR		

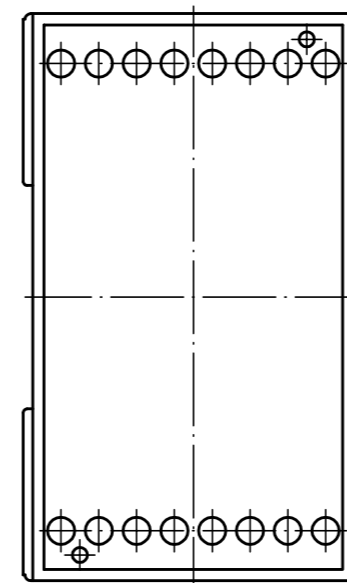
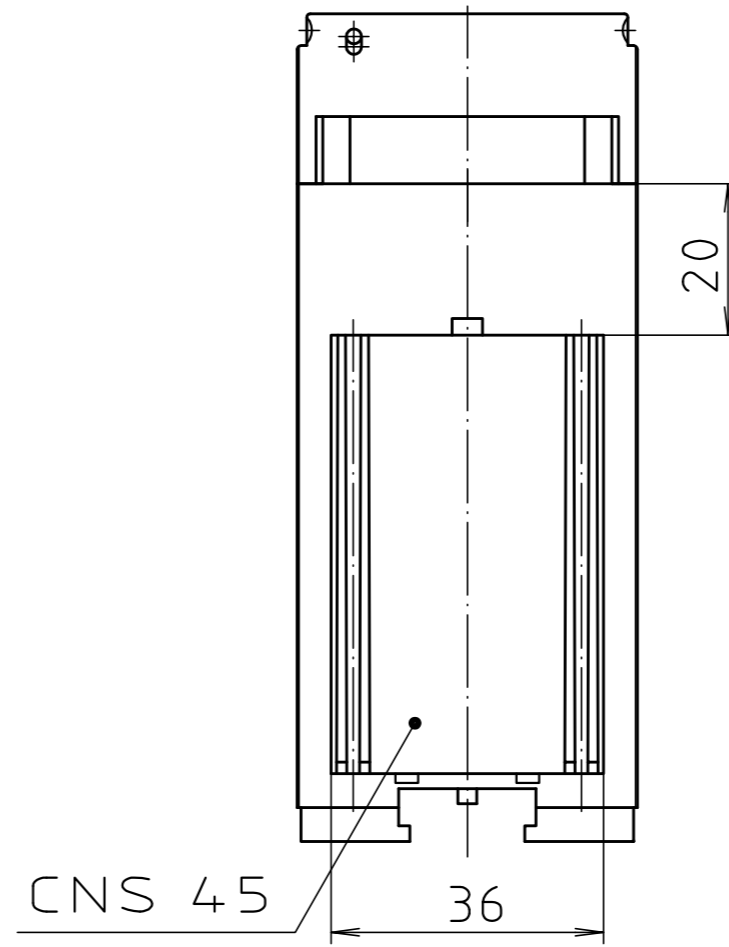
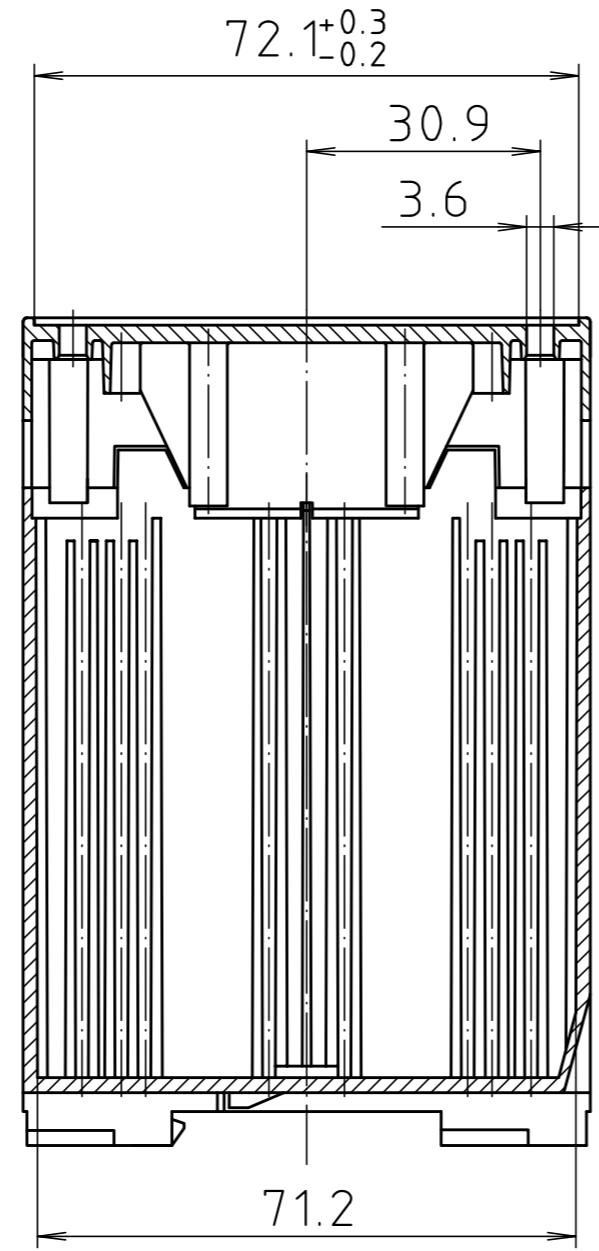
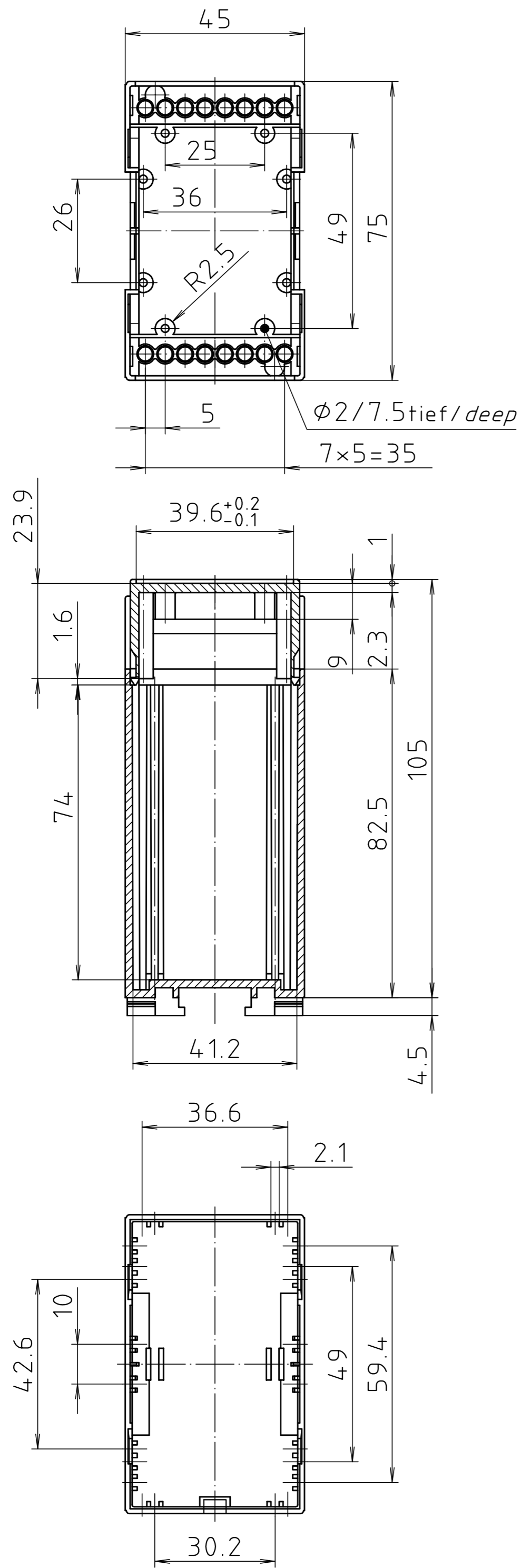