

Cubic, Single-pole 10A Power Relay

- L 19.6 x W 15.6 x H 15.2 (mm)
- Subminiature 'Sugar Cube' relays.
- Standard 360mW – Lower Coil power consumption.
- Standard Class B insulation, (Class F available).
- Standard CTI 175, (CTI 250 available).
- Withstands impulse of up to 4,500V.
- Environmentally friendly product – Cd, Pb and Chromium free.

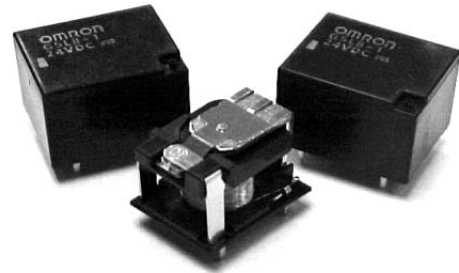

Ordering Information

Sealing	Contact Form	Contact Material
		AgSnO ₂
Unsealed (vent hole)	SPDT	G5LB-1
	SPST-NO	G5LB-1A
Plastic-sealed	SPDT	G5LB-14
	SPST-NO	G5LB-1A4

Note: When ordering, add the rated coil voltage to the number.

Examples : G5LB-1 12 VDC
└──────────┘ Rated Coil Voltage

Model Number Legend

G5LB **VDC**
1 2 3 4 5 6 7 8

1. Number of Poles

1: 1 pole

2. Contact Form/Contact Construction

None: SPDT
 A: SPST-NO

3. Sealing/Protective Construction

None: Unsealed (vent hole)
 4: Sealed

4. Contact Type

None: Standard (Silver Tin Oxide)

5. Coil Power Consumption

None: 360mW
 40: 400mW
 60: 600mW (UL and CSA only)

6. Tracking Index and Insulation

None: CTI >175 – Class B Insulation (colour: black)
 25: CTI >250 – Class F Insulation (colour: white)

7. Optional Suffix(es)

None: Standards
 May include additional numbers(s) and / or letter(s) for sales purposes

8. Rated Coil Value

■ Coil Ratings

Rated voltage	3 VDC	5 VDC	6 VDC	9 VDC	12 VDC	24 VDC	36 VDC	48 VDC
Rated current	123.3 mA	72.0 mA	60.8 mA	40.8 mA	30.7 mA	15.2 mA	10.2 mA	7.6 mA
Coil resistance	24.3 Ω	69.4 Ω	98.7 Ω	220.4 Ω	390.6 Ω	1575.4 Ω	3533.7 Ω	6287.4 Ω
Must operate voltage	75% of rated voltage (max.)							
Must release voltage	10% of rated voltage (min.)							
Max. voltage	130% of rated voltage at 85°C, 170% of rated voltage at 23°C							
Power consumption	Approx. 360 mW							

Note: The rated current and coil resistance are measured at a coil temperature of 23°C with a tolerance of ±10%.

Rated voltage	3 VDC	5 VDC	6 VDC	9 VDC	12 VDC	24 VDC	36 VDC	48 VDC
Rated current	136.4 mA	80.0 mA	67.8 mA	45.7 mA	32.8 mA	17.0 mA	11.3 mA	8.5 mA
Coil resistance	22.0 Ω	62.5 Ω	88.5 Ω	196.9 Ω	366.0 Ω	1,407.7 Ω	3,196.8 Ω	5,638.0 Ω
Must operate voltage	75% of rated voltage (max.)							
Must release voltage	10% of rated voltage (min.)							
Max. voltage	130% of rated voltage at 85°C, 170% of rated voltage at 23°C							
Power consumption	Approx. 400 mW							

Note: The rated current and coil resistance are measured at a coil temperature of 23°C with a tolerance of ±10%.

■ Contact Ratings

Load	Resistive load (cos Ø=1)
Rated load	10A at 120 VAC, 8A at 30 VDC & 10A at 250 VAC
Rated carry current	10A
Max. switching voltage	250 VAC, 125 VDC (30 VDC when UL/CSA standard is applied)
Max. switching current	AC: 10A; DC: 8A
Max. switching capacity	1,200 VA, 240 W & 2,500 VA
Min. permissible load	100 mA at 5 VDC

■ Characteristics

Contact resistance	100 mΩ max.
Operate time	10 ms max.
Release time	5 ms max.
Max. switching frequency	Mechanical: 18,000 operations/hr Electrical: 1,800 operations/hr (under rated load)
Insulation resistance	100MΩ min. (at 500 VDC)
Dielectric strength	750 VAC, 50/60 Hz for 1 min. between contacts of same polarity 2,000 VAC, 50/60 Hz for 1 min. between coil and contacts
Impulse withstand voltage	4,500V between coil and contacts, 1.2 x 5 μsec
Vibration resistance	Destruction: 10 to 55Hz, 1.5mm double amplitude Malfunction: 10 to 55Hz, 1.5mm double amplitude
Shock resistance	Destruction: 1,000 m/s ² (approx. 100G) Malfunction: 100 m/s ² (approx. 10G)
Life expectancy	Mechanical: 10,000,000 operations min. (at 18,000 operations/hr) Electrical: *100,000 operations min. (at 1,800 operations/hr, 10A 120VAC)
Ambient temperature	Operating: -40°C to 85°C
Ambient humidity	Operating: 35% to 85°C
Weight	Approx. 10g

*G5LB-1

Engineering Data

Max. Switching Capacity G5LB-1

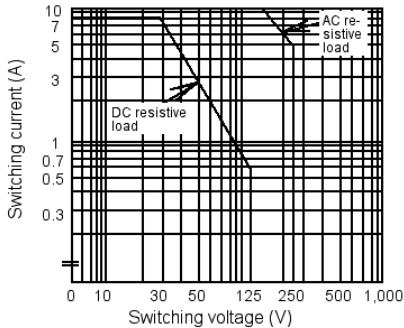

Life Expectancy G5LB-1

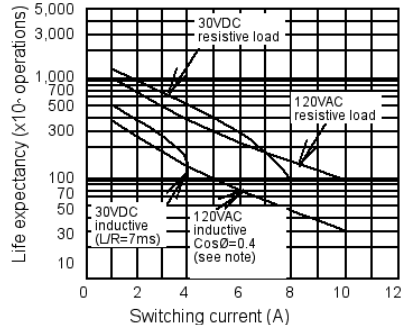

Note: Curve 120VAC inductive Cosφ=0.4 is same for 250VAC resistive load.

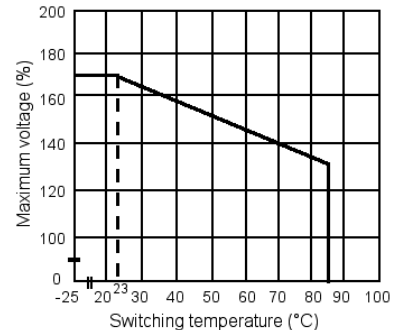

Ambient Temp. Vs Max. Voltage



Note: The maximum coil voltage refers to the maximum value in a varying range of operating power voltage, not a continuous voltage.

Dimensions

Note: 1. All units are millimeters unless otherwise indicated

2. Orientation marks are indicated as follow:  

■ SPDT Types

G5LB-1

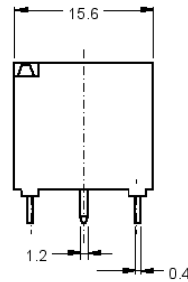
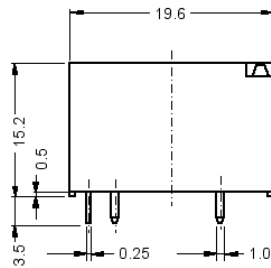

Terminal Arrangement/
Internal Connections
(Bottom View)

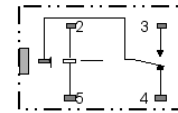

Mounting Holes
(Bottom View)
Tolerance: $\pm 0.1\text{mm}$

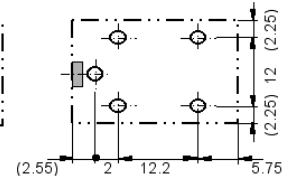

G5LB-14

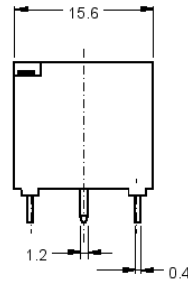
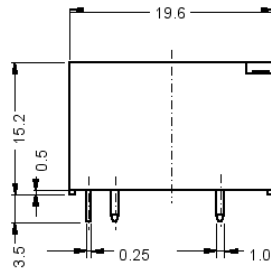

Terminal Arrangement/
Internal Connections
(Bottom View)

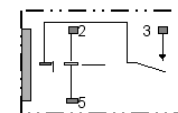

Mounting Holes
(Bottom View)
Tolerance: $\pm 0.1\text{mm}$

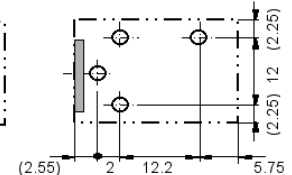

■ SPST Types

G5LB-1A

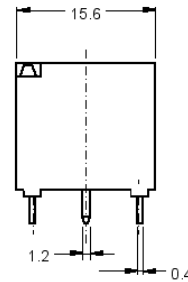
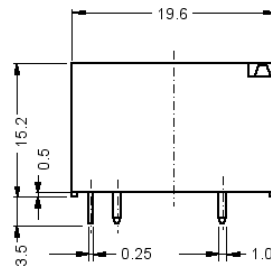

Terminal Arrangement/
Internal Connections
(Bottom View)

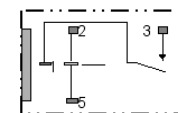

Mounting Holes
(Bottom View)
Tolerance: $\pm 0.1\text{mm}$

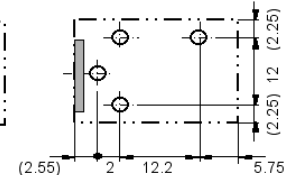

G5LB-1A4

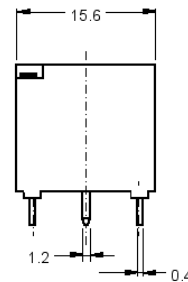
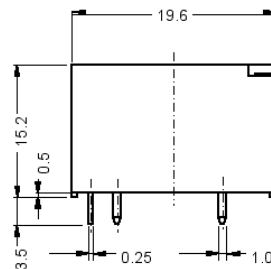

ALL DIMENSIONS SHOWN ARE IN MILLIMETERS.

To convert millimeters into inches, multiply by 0.03937. To convert grams into ounces, multiply by 0.03527.