

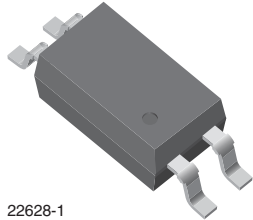

Optocoupler, Phototransistor Output, Single Channel, Half Pitch Mini-Flat Package

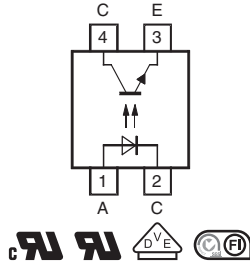

22628-1



FEATURES

- Low profile package (half pitch)
- AC isolation test voltage 3750 V_{RMS}
- Low coupling capacitance of typical 0.3 pF
- Current transfer ratio (CTR) selected into groups
- Low temperature coefficient of CTR
- Wide ambient temperature range
- Material categorization: for definitions of compliance please see www.vishay.com/doc?99912



RoHS
COMPLIANT

DESCRIPTION

The TCMT110. series consist of a phototransistor optically coupled to a gallium arsenide infrared-emitting diode in a 4 pin package.

The elements are mounted on one leadframe providing a fixed distance between input and output for highest safety requirements.

APPLICATIONS

- Programmable logic controllers
- Modems
- Answering machines
- General applications

AGENCY APPROVALS

- UL1577, file no. E76222, double protection
- cUL component acceptance service no. 5A, double protection
- DIN EN 60747-5-5 (VDE 0884-5)
- FIMKO: FI EN 60950-1:2006
- BSI: BS EN60065:2002
BS EN60950-1:2006
- CQC GB 8898-2011, GB 4943.1-2011 (suitable for installation altitude below 2000 m)

| ORDERING INFORMATION | | | | | | | | | | |
|---|-----------|----------|-----------|------------|------------|-----------|------------|--|------------|------------|
| <div style="display: flex; justify-content: space-around; align-items: center;"> <div style="border: 1px solid black; padding: 5px; margin: 2px;">T</div> <div style="border: 1px solid black; padding: 5px; margin: 2px;">C</div> <div style="border: 1px solid black; padding: 5px; margin: 2px;">M</div> <div style="border: 1px solid black; padding: 5px; margin: 2px;">T</div> <div style="border: 1px solid black; padding: 5px; margin: 2px;">1</div> <div style="border: 1px solid black; padding: 5px; margin: 2px;">1</div> <div style="border: 1px solid black; padding: 5px; margin: 2px;">0</div> <div style="border: 1px solid black; padding: 5px; margin: 2px;">#</div> </div> <p style="text-align: center; margin-top: 5px;">PART NUMBER</p> | | | | | | | | | | |
| AGENCY CERTIFIED/ PACKAGE | CTR (%) | | | | | | | | | |
| | 5 mA | 10 mA | | | | 5 mA | | | | |
| UL, cUL, FIMKO, BSI, VDE | 50 to 600 | 40 to 80 | 63 to 125 | 100 to 200 | 160 to 320 | 50 to 150 | 100 to 300 | 80 to 160 | 130 to 260 | 200 to 400 |
| SSOP-4 | TCMT1100 | TCMT1101 | TCMT1102 | TCMT1103 | TCMT1104 | TCMT1105 | TCMT1106 | TCMT1107, TCMT1107T3 ⁽¹⁾ | TCMT1108 | TCMT1109 |

Notes

- Available only on tape and reel
- ⁽¹⁾ Product is rotated 180° in tape and reel cavity



| ABSOLUTE MAXIMUM RATINGS (T _{amb} = 25 °C, unless otherwise specified) | | | | |
|---|---|-------------------|-------------|------------------|
| PARAMETER | TEST CONDITION | SYMBOL | VALUE | UNIT |
| INPUT | | | | |
| Reverse voltage | | V _R | 6 | V |
| Forward current | | I _F | 60 | mA |
| Forward surge current | t _p ≤ 10 μs | I _{FSM} | 1.5 | A |
| Power dissipation | | P _{diss} | 100 | mW |
| Junction temperature | | T _j | 125 | °C |
| OUTPUT | | | | |
| Collector emitter voltage | | V _{CEO} | 70 | V |
| Emitter collector voltage | | V _{ECO} | 7 | V |
| Collector current | | I _C | 50 | mA |
| Collector peak current | t _p /T = 0.5, t _p ≤ 10 ms | I _{CM} | 100 | mA |
| Power dissipation | | P _{diss} | 150 | mW |
| Junction temperature | | T _j | 125 | °C |
| COUPLER | | | | |
| AC isolation test voltage (RMS) | Related to standard climate 23/50 DIN 50014 | V _{ISO} | 3750 | V _{RMS} |
| Total power dissipation | | P _{tot} | 250 | mW |
| Operating ambient temperature range | | T _{amb} | -40 to +100 | °C |
| Storage temperature range | | T _{stg} | -40 to +125 | °C |
| Soldering temperature ⁽¹⁾ | | T _{slid} | 260 | °C |

Notes

- Stresses in excess of the absolute maximum ratings can cause permanent damage to the device. Functional operation of the device is not implied at these or any other conditions in excess of those given in the operational sections of this document. Exposure to absolute maximum ratings for extended periods of the time can adversely affect reliability
- ⁽¹⁾ Refer to reflow profile for soldering conditions for surface mounted devices. Also refer to “Assembly Instructions” (www.vishay.com/doc?80054)

| ELECTRICAL CHARACTERISTICS (T _{amb} = 25 °C, unless otherwise specified) | | | | | | |
|---|--|--------------------|------|------|------|------|
| PARAMETER | TEST CONDITION | SYMBOL | MIN. | TYP. | MAX. | UNIT |
| INPUT | | | | | | |
| Forward voltage | I _F = 50 mA | V _F | - | 1.35 | 1.6 | V |
| Junction capacitance | V _R = 0, f = 1 MHz | C _j | - | 8 | | pF |
| OUTPUT | | | | | | |
| Collector emitter voltage | I _C = 100 μA | V _{CEO} | 70 | - | - | V |
| Emitter collector voltage | I _E = 100 μA | V _{ECO} | 7 | - | - | V |
| Collector dark current | V _{CE} = 20 V, I _F = 0 A | I _{CEO} | - | - | 100 | nA |
| COUPLER | | | | | | |
| Collector emitter saturation voltage | I _F = 10 mA, I _C = 1 mA | V _{CEsat} | - | - | 0.3 | V |
| Cut-off frequency | V _{CE} = 5 V, I _F = 10 mA, R _L = 100 Ω | f _c | - | 100 | - | kHz |
| Coupling capacitance | f = 1 MHz | C _k | - | 0.3 | - | pF |

Note

- Minimum and maximum values are testing requirements. Typical values are characteristics of the device and are the result of engineering evaluation. Typical values are for information only and are not part of the testing requirements

| CURRENT TRANSFER RATIO ($T_{amb} = 25^\circ C$, unless otherwise specified) | | | | | | | |
|---|-----------------------------|----------|--------|------|------|------|------|
| PARAMETER | TEST CONDITION | PART | SYMBOL | MIN. | TYP. | MAX. | UNIT |
| I_C/I_F | $V_{CE} = 5 V, I_F = 5 mA$ | TCMT1100 | CTR | 50 | - | 600 | % |
| | $V_{CE} = 5 V, I_F = 10 mA$ | TCMT1101 | CTR | 40 | - | 80 | % |
| | | TCMT1102 | CTR | 63 | - | 125 | % |
| | | TCMT1103 | CTR | 100 | - | 200 | % |
| | | TCMT1104 | CTR | 160 | - | 320 | % |
| | $V_{CE} = 5 V, I_F = 5 mA$ | TCMT1105 | CTR | 50 | - | 150 | % |
| | | TCMT1106 | CTR | 100 | - | 300 | % |
| | | TCMT1107 | CTR | 80 | - | 160 | % |
| | | TCMT1108 | CTR | 130 | - | 260 | % |
| TCMT1109 | | CTR | 200 | - | 400 | % | |

| SWITCHING CHARACTERISTICS ($T_{amb} = 25^\circ C$, unless otherwise specified) | | | | | | | |
|--|--|-----------|------|------|------|---------|--|
| PARAMETER | TEST CONDITION | SYMBOL | MIN. | TYP. | MAX. | UNIT | |
| Delay time | $V_S = 5 V, I_C = 2 mA, R_L = 100 \Omega$, (see figure 1) | t_d | - | 4.0 | - | μs | |
| Rise time | $V_S = 5 V, I_C = 2 mA, R_L = 100 \Omega$, (see figure 1) | t_r | - | 5.5 | - | μs | |
| Fall time | $V_S = 5 V, I_C = 2 mA, R_L = 100 \Omega$, (see figure 1) | t_f | - | 7.0 | - | μs | |
| Storage time | $V_S = 5 V, I_C = 2 mA, R_L = 100 \Omega$, (see figure 1) | t_s | - | 1.5 | - | μs | |
| Turn-on time | $V_S = 5 V, I_C = 2 mA, R_L = 100 \Omega$, (see figure 1) | t_{on} | - | 9.5 | - | μs | |
| Turn-off time | $V_S = 5 V, I_C = 2 mA, R_L = 100 \Omega$, (see figure 1) | t_{off} | - | 8.5 | - | μs | |
| Turn-on time | $V_S = 5 V, I_F = 10 mA, R_L = 1 k\Omega$, (see figure 2) | t_{on} | - | 3.0 | - | μs | |
| Turn-off time | $V_S = 5 V, I_F = 10 mA, R_L = 1 k\Omega$, (see figure 2) | t_{off} | - | 20.0 | - | μs | |

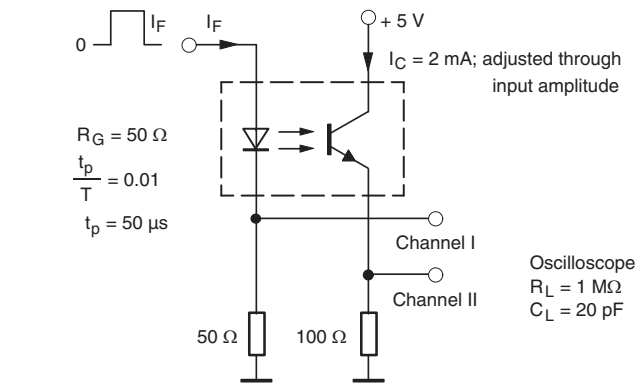

95 10804

Fig. 1 - Test Circuit, Non-Saturated Operation

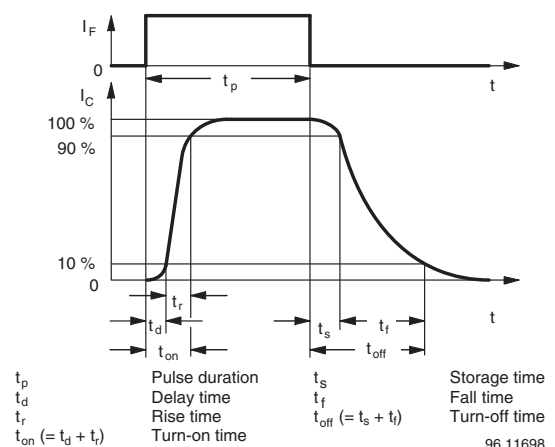
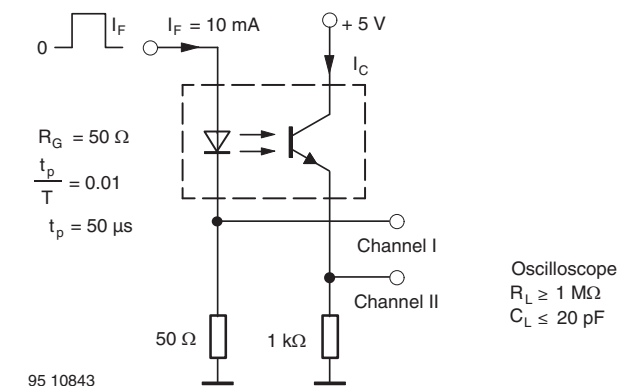

Fig. 3 - Switching Times



95 10843

Fig. 2 - Test Circuit, Saturated Operation

| SAFETY AND INSULATION RATINGS | | | | |
|--|---|-------------------|--------------------|-------------------|
| PARAMETER | TEST CONDITION | SYMBOL | VALUE | UNIT |
| Climatic classification | According to IEC 68 part 1 | | 40 / 110 / 21 | |
| Pollution degree | According to DIN VDE 0109 | | 2 | |
| Comparative tracking index | Insulation group IIIa | CTI | 175 | |
| Maximum rated withstanding isolation voltage | According to UL1577, t = 1 min | V _{ISO} | 3750 | V _{RMS} |
| Maximum transient isolation voltage | According to DIN EN 60747-5-5 | V _{IOTM} | 6000 | V _{peak} |
| Maximum repetitive peak isolation voltage | According to DIN EN 60747-5-5 | V _{IORM} | 707 | V _{peak} |
| Isolation resistance | T _{amb} = 25 °C, V _{IO} = 500 V | R _{IO} | ≥ 10 ¹² | Ω |
| | T _{amb} = 100 °C, V _{IO} = 500 V | | ≥ 10 ¹¹ | |
| | T _{amb} = T _S , V _{IO} = 500 V | | ≥ 10 ⁹ | |
| Output safety power | | P _{SO} | 350 | mW |
| Input safety current | | I _{SI} | 150 | mA |
| Input safety temperature | | T _S | 175 | °C |
| Creepage distance | | | ≥ 5 | mm |
| Clearance distance | | | ≥ 5 | mm |
| Insulation thickness | | DTI | ≥ 0.4 | mm |
| Input to output test voltage, method B | V _{IORM} × 1.875 = V _{PR} , 100 % production test with t _M = 1 s, partial discharge < 5 pC | V _{PR} | 1326 | V _{peak} |
| Input to output test voltage, method A | V _{IORM} × 1.6 = V _{PR} , 100 % sample test with t _M = 10 s, partial discharge < 5 pC | V _{PR} | 1132 | V _{peak} |

TYPICAL CHARACTERISTICS (T_{amb} = 25 °C, unless otherwise specified)

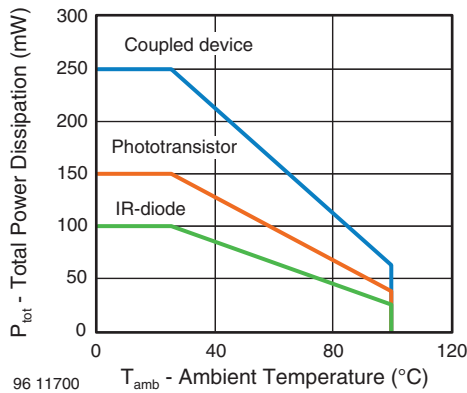

Fig. 4 - Total Power Dissipation vs. Ambient Temperature

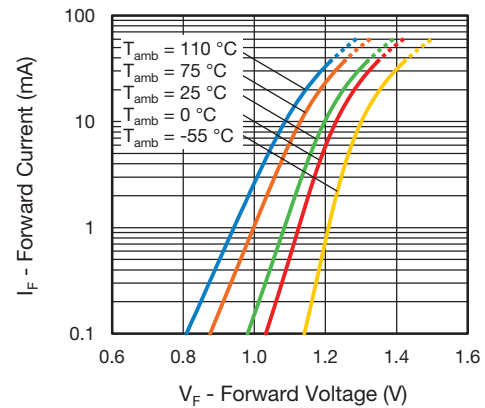

Fig. 5 - Forward Voltage vs. Forward Current

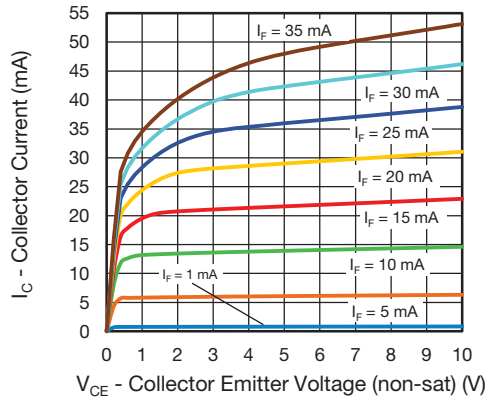

Fig. 6 - Collector Current vs. Collector Emitter Voltage

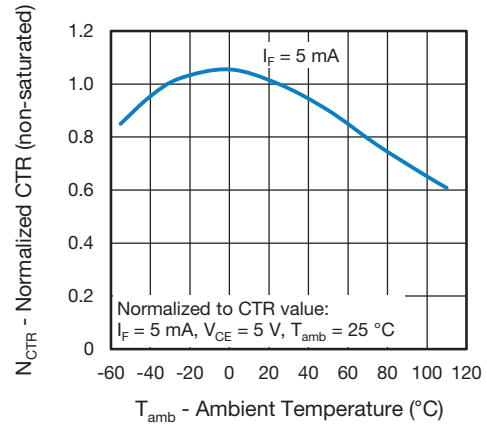

Fig. 9 - Normalized Current Transfer Ratio (non-saturated) vs. Ambient Temperature

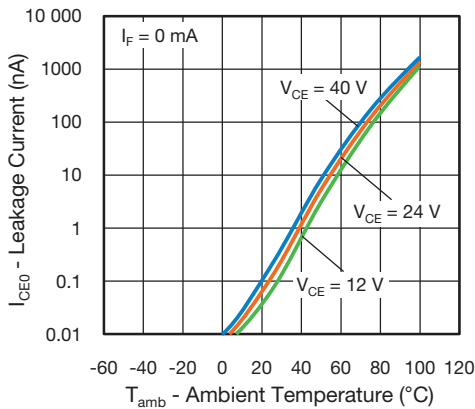

Fig. 7 - Leakage Current vs. Ambient Temperature

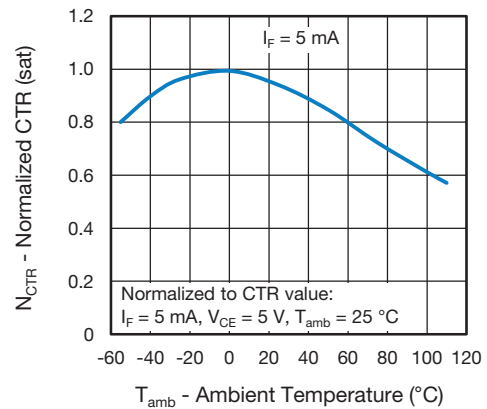

Fig. 10 - Normalized Current Transfer Ratio (saturated) vs. Ambient Temperature

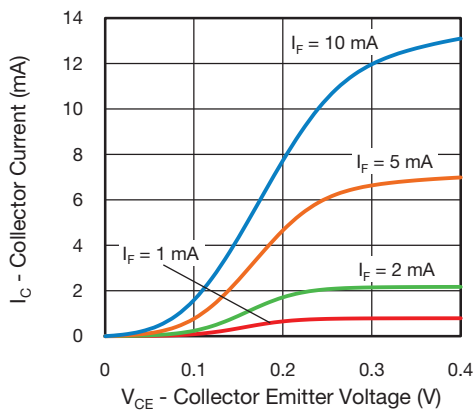

Fig. 8 - Collector Current vs. Collector Emitter Voltage

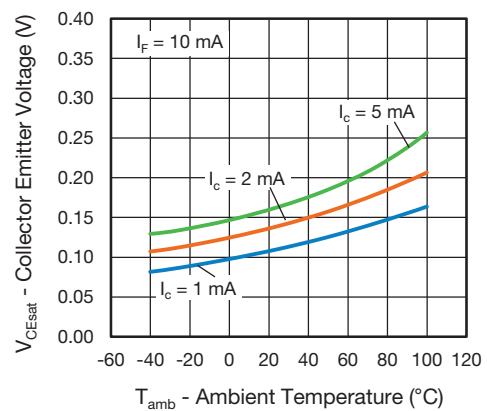

Fig. 11 - Collector Emitter Voltage vs. Ambient Temperature

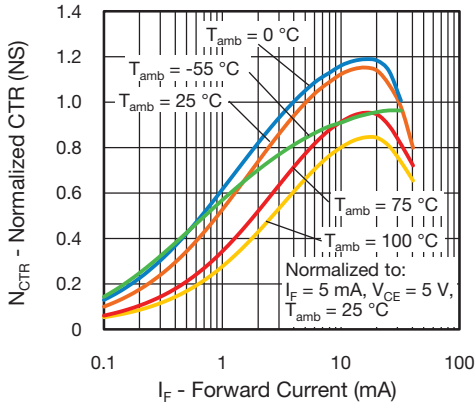

Fig. 12 - Normalized CTR (non-saturated) vs. Forward Current

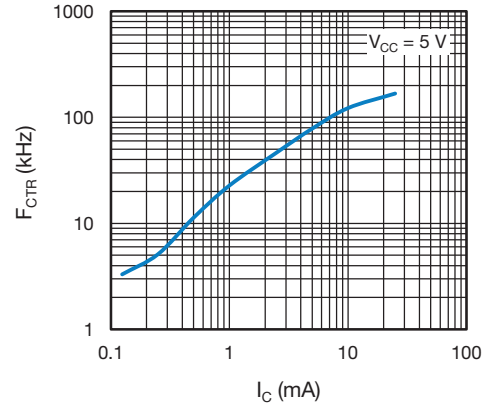

Fig. 15 - F_{CTR} vs. Collector Current

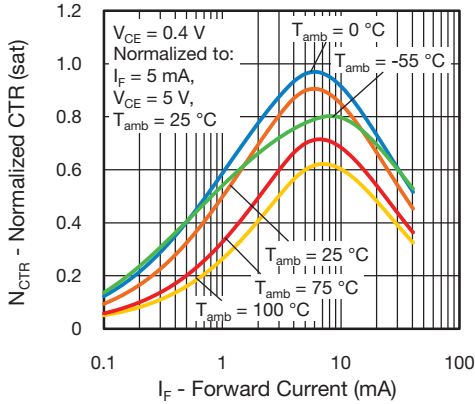

Fig. 13 - Normalized CTR (saturated) vs. Forward Current

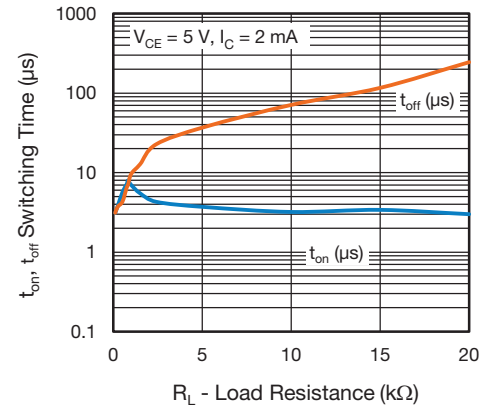

Fig. 16 - Switching Time vs. Load Resistance

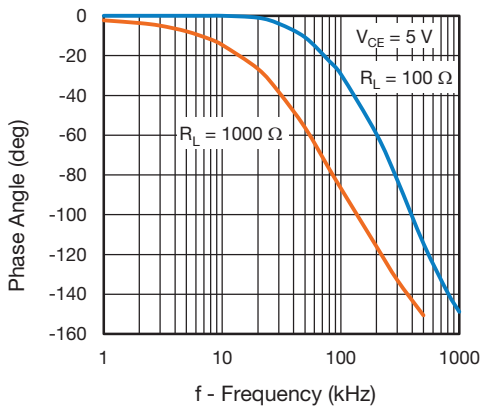
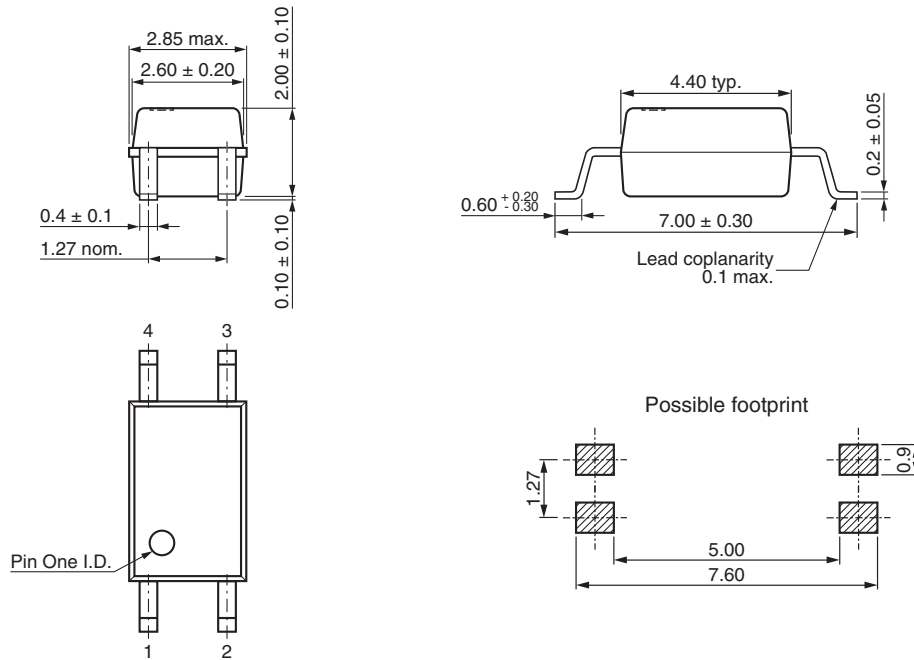

Fig. 14 - F_{CTR} vs. Phase Angle



PACKAGE DIMENSIONS in millimeters



PACKAGE MARKING (example)

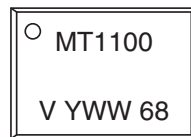

TAPE AND REEL PACKAGING in millimeters

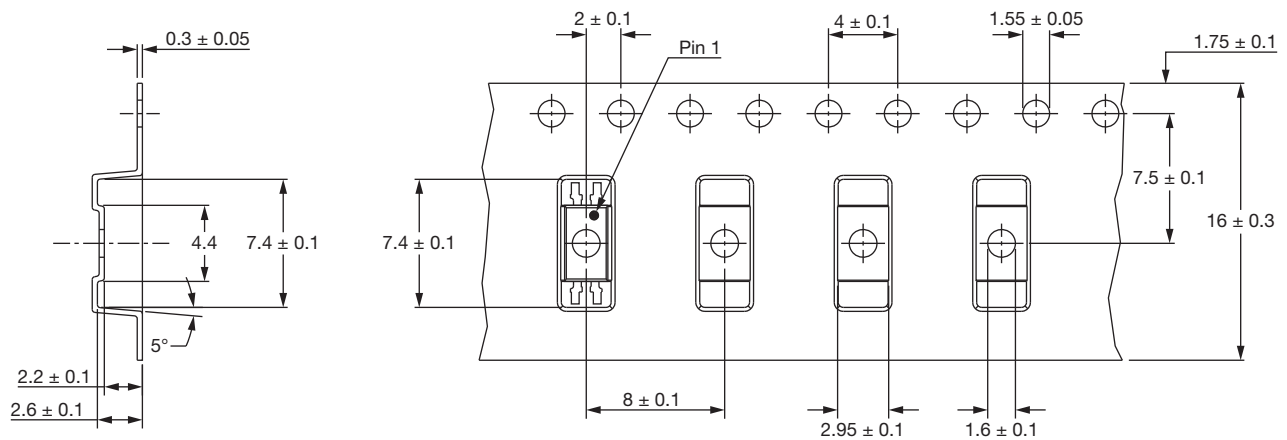
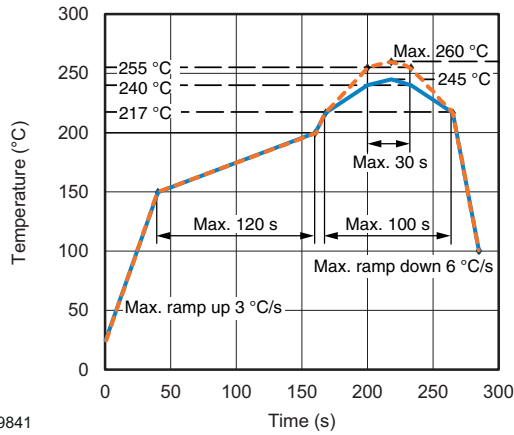

Fig. 17



SOLDER PROFILES



19841

Fig. 18 - Lead (Pb)-free Reflow Solder Profile According to J-STD-020 for SMD Devices

HANDLING AND STORAGE CONDITIONS

ESD level: HBM class 2

Floor life: unlimited

Conditions: $T_{amb} < 30\text{ °C}$, RH < 85 %

Moisture sensitivity level 1, according to J-STD-020



Disclaimer

ALL PRODUCT, PRODUCT SPECIFICATIONS AND DATA ARE SUBJECT TO CHANGE WITHOUT NOTICE TO IMPROVE RELIABILITY, FUNCTION OR DESIGN OR OTHERWISE.

Vishay Intertechnology, Inc., its affiliates, agents, and employees, and all persons acting on its or their behalf (collectively, "Vishay"), disclaim any and all liability for any errors, inaccuracies or incompleteness contained in any datasheet or in any other disclosure relating to any product.

Vishay makes no warranty, representation or guarantee regarding the suitability of the products for any particular purpose or the continuing production of any product. To the maximum extent permitted by applicable law, Vishay disclaims (i) any and all liability arising out of the application or use of any product, (ii) any and all liability, including without limitation special, consequential or incidental damages, and (iii) any and all implied warranties, including warranties of fitness for particular purpose, non-infringement and merchantability.

Statements regarding the suitability of products for certain types of applications are based on Vishay's knowledge of typical requirements that are often placed on Vishay products in generic applications. Such statements are not binding statements about the suitability of products for a particular application. It is the customer's responsibility to validate that a particular product with the properties described in the product specification is suitable for use in a particular application. Parameters provided in datasheets and / or specifications may vary in different applications and performance may vary over time. All operating parameters, including typical parameters, must be validated for each customer application by the customer's technical experts. Product specifications do not expand or otherwise modify Vishay's terms and conditions of purchase, including but not limited to the warranty expressed therein.

Hyperlinks included in this datasheet may direct users to third-party websites. These links are provided as a convenience and for informational purposes only. Inclusion of these hyperlinks does not constitute an endorsement or an approval by Vishay of any of the products, services or opinions of the corporation, organization or individual associated with the third-party website. Vishay disclaims any and all liability and bears no responsibility for the accuracy, legality or content of the third-party website or for that of subsequent links.

Except as expressly indicated in writing, Vishay products are not designed for use in medical, life-saving, or life-sustaining applications or for any other application in which the failure of the Vishay product could result in personal injury or death. Customers using or selling Vishay products not expressly indicated for use in such applications do so at their own risk. Please contact authorized Vishay personnel to obtain written terms and conditions regarding products designed for such applications.

No license, express or implied, by estoppel or otherwise, to any intellectual property rights is granted by this document or by any conduct of Vishay. Product names and markings noted herein may be trademarks of their respective owners.