

Klemmen

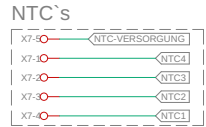

I2C Display

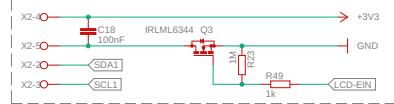

Wassermelder und Bedienung



Akkupack



Programmierport

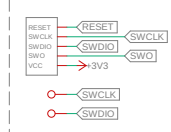

Anzeige Ladezustand

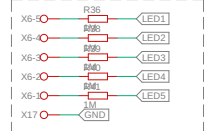

Entlade/Heizdraht

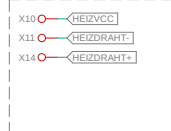

Spannung Linearregler

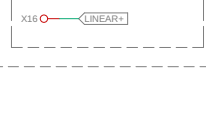

Akku Schutzschaltung

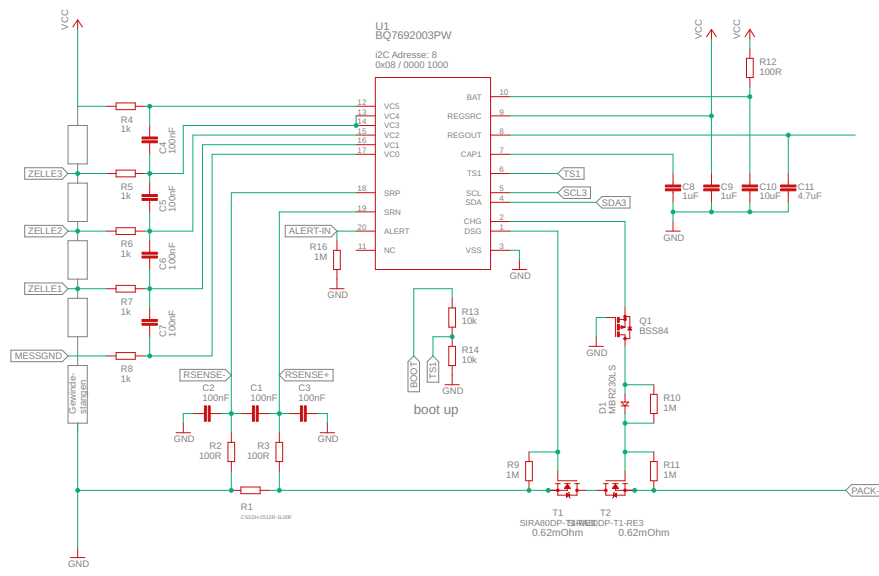

3,3V Versorgung

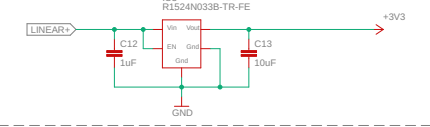

Temperaturmessungen

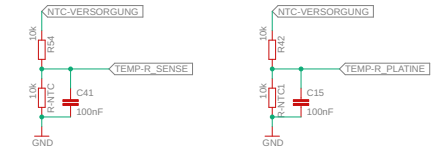
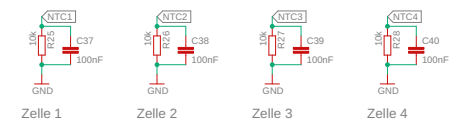

STM32WB5MM

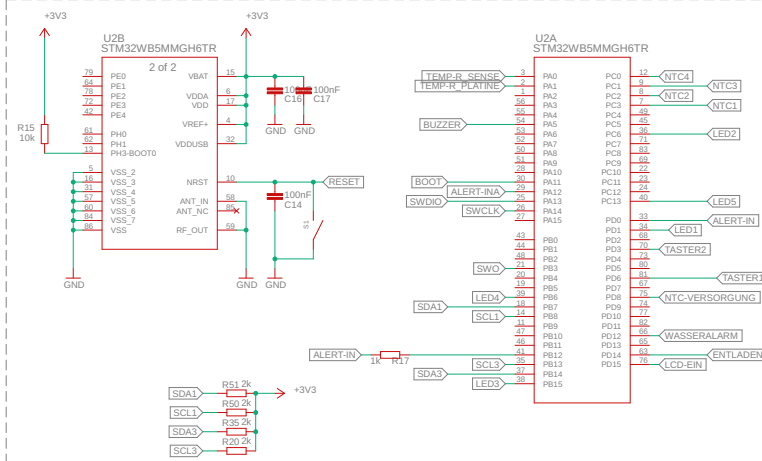

Wassermelder und Bedienung

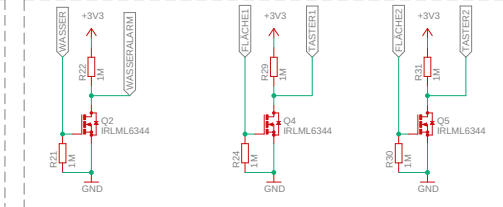

Buzzer

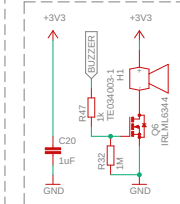

Entladewiderstand

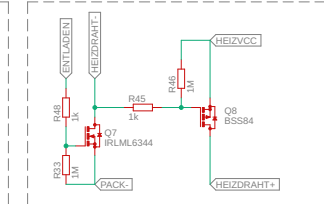

PWM -> DC (Glättung und Messung mit INA226)

