

T-Kreuzung mit 2 Fußgängerüberwegen

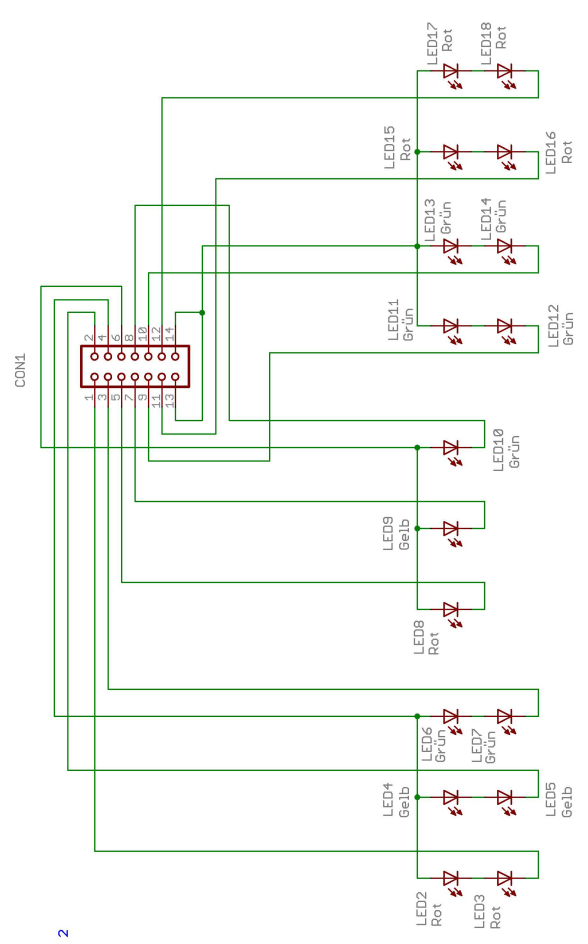

Dieser Teil ist bereits fertig aufgebaut!

Zählweise Pins am IC

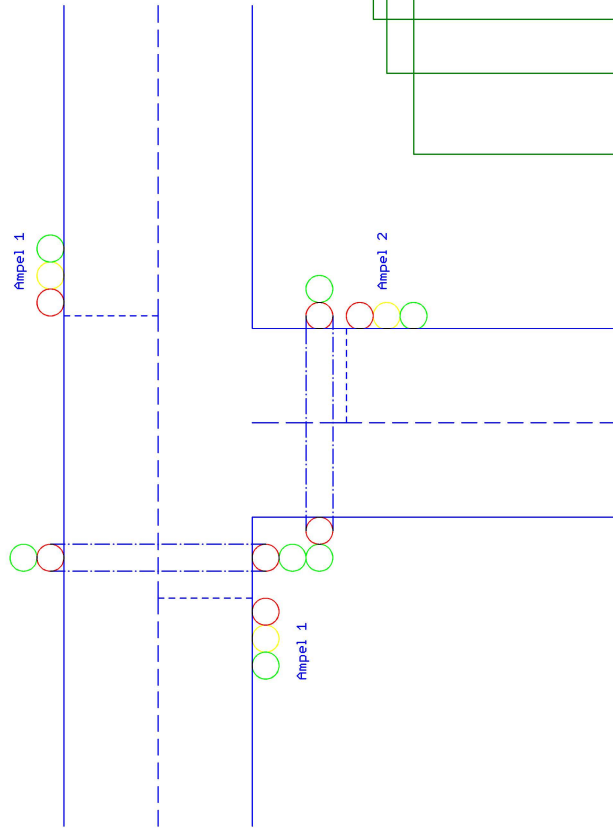
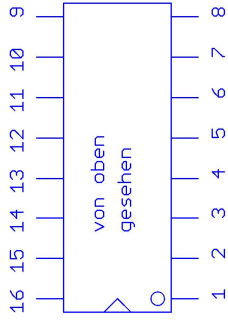

Diode

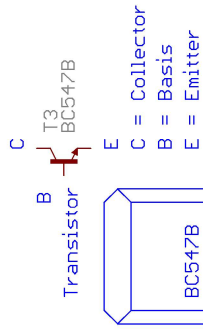
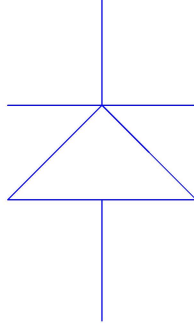
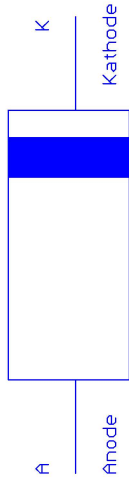

Transistor
T3
BC547B
C = Collector
B = Basis
E = Emitter

Leuchtdiode
LED1
Rot

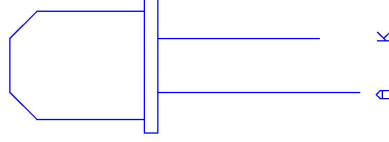

A = Anode
K = Kathode
Merksatz: "Kurz - Kathode"