



General

■ Applications

-Dual function time relay can be used for industrial equipment, lighting control, heating element control, motor and fan control, with two delay modes, and the delay range covers 0.1 seconds to 10days.

■ Function Features

- Two delay modes can be set.
- Supports AC230V ,AC/DC24V two kinds of working voltage.
- Ultra wide delay range, 0.1 seconds - 10 days can be set..
- The working state of the relay is indicated by the LED indicator.
- Ultra small size, only 18mm width, 35mm rail installation.

■ Model and connotation

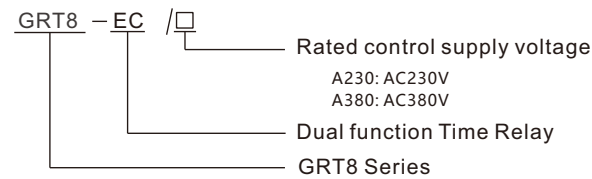

Technical parameters

	GRT8-EC
Function	ON delay, Delay off
Supply terminals	A1-A2(AC230V,AC380V),A1-A3(AC/DC24V)
Voltage range	AC230V(50-60Hz) or AC/DC24V, AC380V(50-60Hz)
Power input	AC max.6VA/1.3W
Supply voltage tolerance	-15%;+10%
Supply indication	green LED
Time ranges	0.1s-10day
Time setting	potentionmeter
Time deviation	≤10%
Repeat accuracy	0.2%-set value stability
Temperature coefficient	0.05%/°C,at=20°C(0.05%/°F, at=68°F)
Output	1×SPDT
Current rating	1×10A(AC1)
Switching voltage	250VAC/24VDC
Min.breaking capacity DC	500mW
Output indication	red LED
Mechanical life	1×10 ⁷
Electrical life(AC1)	1×10 ⁵
Reset time	max.200ms
Operating temperature	-20°C to +55°C (-4°F to 131°F)
Storage temperature	-35°C to +75°C (-22°F to 158°F)
Mounting/DIN rail	Din rail EN/IEC 60715
Protection degree	IP40 for front panel/IP20 terminals
Operating position	any
Overvoltage cathegory	III.
Pollution degree	2
Max.cable size(mm ²)	solid wire max.1×2. 5or 2×1. 5/with sleeve max.1×2. 5(AWG 12)
Dimensions	90×18×64mm
Weight	52g
Standards	EN 61812-1,IEC60947-5-1

Panel Diagram

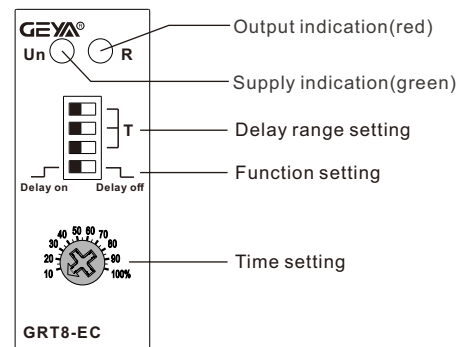

Wiring diagram

GRT8-EC/A220

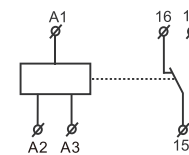

GRT8-EC/A380

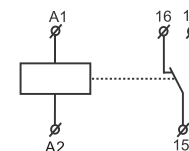

Function

Delay on

When the relay Un is powered on, the relay starts to delay, and the output contact closes after delay. When Un is powered off, the output contact is disconnected.



Delay off

When the relay Un is powered on, the output contact of the relay will close immediately and start to delay, and output after delay. The contact is open. If the delay time t is not up to the power loss of relay Un, the output contact is open.



Delay range setting

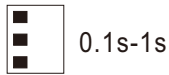

0.1s-1s

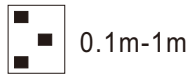

0.1m-1m



0.1h-1h



0.1d-1d



1s-10s

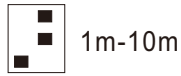

1m-10m



1h-10h



1d-10d

Delay setting

- 1、 Set the delay range and function mode through the switch on the panel.
- 2、 Set potentiometer to set time.

Example 1: Set the working mode as delay on mode, set it for 5 seconds, and set it as follows

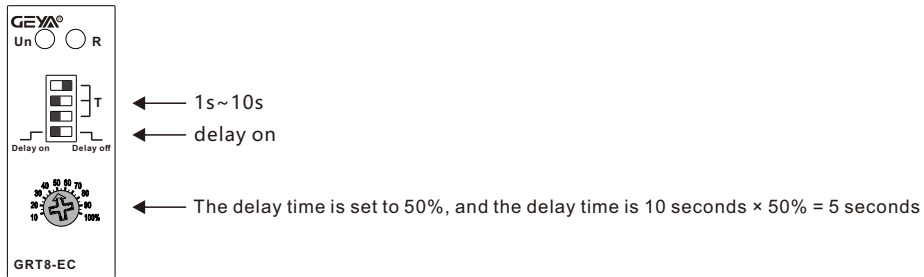

Example 2: Set the working mode as delay off mode, set it for 10 minutes, and set it as follows

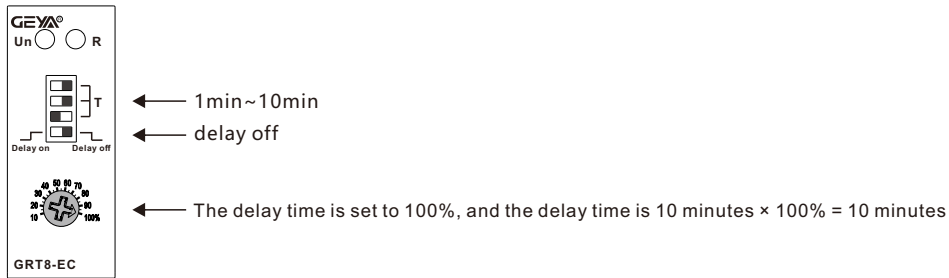

Dimensions(mm)

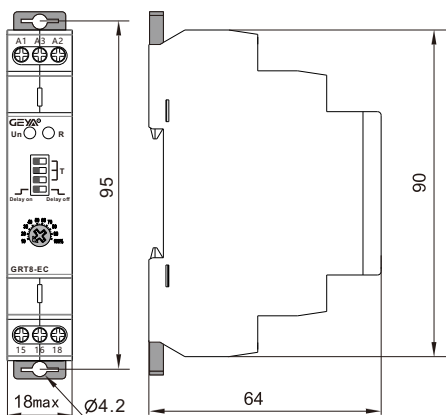

Disposal of Electrical Waste
All electrical waste should be disposed of in compliance with current WEEE regulations.



Caution
The products must be installed by qualified electricians. All and any electrical connections of the time relay shall comply with the appropriate safety standards.