

**PNP Silicon AF Transistor**

- High breakdown voltage
- Low collector-emitter saturation voltage
- Complementary type: SMBTA 06 (NPN)

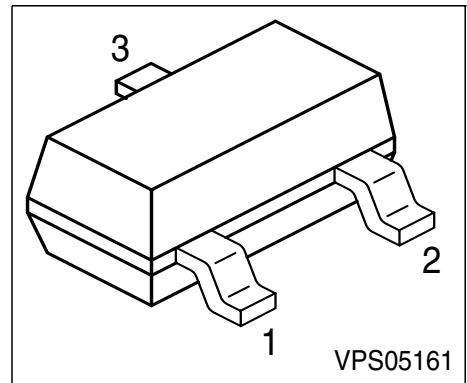

Type	Marking	Pin Configuration			Package
SMBTA 56	s2G	1=B	2=E	3=C	SOT-23

**Maximum Ratings**

Parameter	Symbol	Value	Unit
Collector-emitter voltage	$V_{CEO}$	80	V
Collector-base voltage	$V_{CBO}$	80	
Emitter-base voltage	$V_{EBO}$	4	
DC collector current	$I_C$	500	mA
Peak collector current	$I_{CM}$	1	A
Base current	$I_B$	100	mA
Peak base current	$I_{BM}$	200	
Total power dissipation, $T_S = 79\text{ °C}$	$P_{tot}$	330	mW
Junction temperature	$T_j$	150	°C
Storage temperature	$T_{stg}$	-65 ... 150	

**Thermal Resistance**

Junction ambient <sup>1)</sup>	$R_{thJA}$	≤285	K/W
Junction - soldering point	$R_{thJS}$	≤215	

1) Package mounted on pcb 40mm x 40mm x 1.5mm / 6cm<sup>2</sup> Cu

**Electrical Characteristics at  $T_A = 25^\circ\text{C}$ , unless otherwise specified**

Parameter	Symbol	Values			Unit
		min.	typ.	max.	
<b>DC Characteristics</b>					
Collector-emitter breakdown voltage $I_C = 1 \text{ mA}, I_B = 0$	$V_{(BR)CEO}$	80	-	-	V
Collector-base breakdown voltage $I_C = 100 \mu\text{A}, I_B = 0$	$V_{(BR)CBO}$	80	-	-	
Emitter-base breakdown voltage $I_E = 10 \mu\text{A}, I_C = 0$	$V_{(BR)EBO}$	4	-	-	
Collector cutoff current $V_{CB} = 80 \text{ V}, I_E = 0$	$I_{CBO}$	-	-	100	nA
Collector cutoff current $V_{CB} = 80 \text{ V}, I_E = 0, T_A = 150^\circ\text{C}$	$I_{CBO}$	-	-	20	$\mu\text{A}$
Collector cutoff current $V_{CE} = 60 \text{ V}, I_B = 0$	$I_{CEO}$	-	-	100	nA
DC current gain 1) $I_C = 10 \text{ mA}, V_{CE} = 1 \text{ V}$ $I_C = 100 \text{ mA}, V_{CE} = 1 \text{ V}$	$h_{FE}$	100 100	- -	- -	-
Collector-emitter saturation voltage 1) $I_C = 100 \text{ mA}, I_B = 10 \text{ mA}$	$V_{CEsat}$	-	-	0.25	V
Base-emitter voltage 1) $I_C = 100 \text{ mA}, V_{CE} = 1 \text{ V}$	$V_{BE(ON)}$	-	-	1.2	
<b>AC Characteristics</b>					
Transition frequency $I_C = 20 \text{ mA}, V_{CE} = 5 \text{ V}, f = 20 \text{ MHz}$	$f_T$	-	100	-	MHz
Collector-base capacitance $V_{CB} = 10 \text{ V}, f = 1 \text{ MHz}$	$C_{cb}$	-	12	-	pF

 1) Pulse test:  $t \leq 300\mu\text{s}$ ,  $D = 2\%$

**Total power dissipation  $P_{tot} = f(T_A^*; T_S)$**

\* Package mounted on epoxy

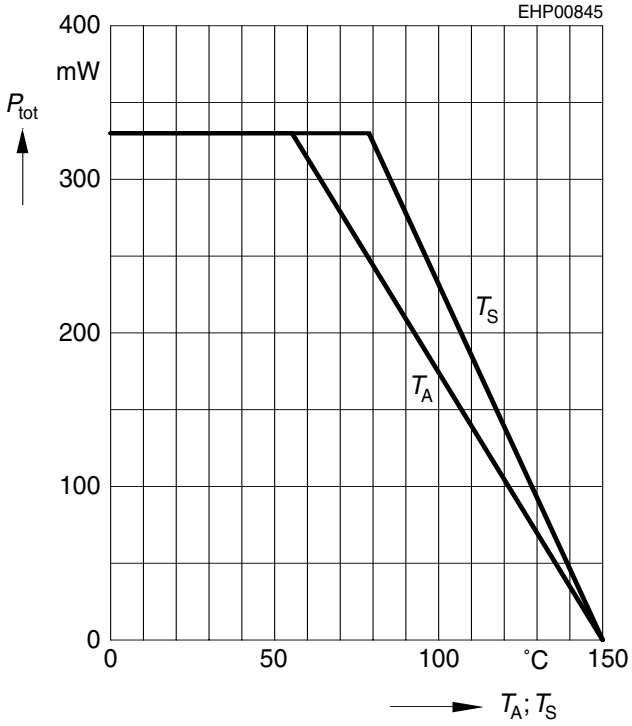

**Collector current  $I_C = f(V_{BE})$**

$V_{CE} = 1V$

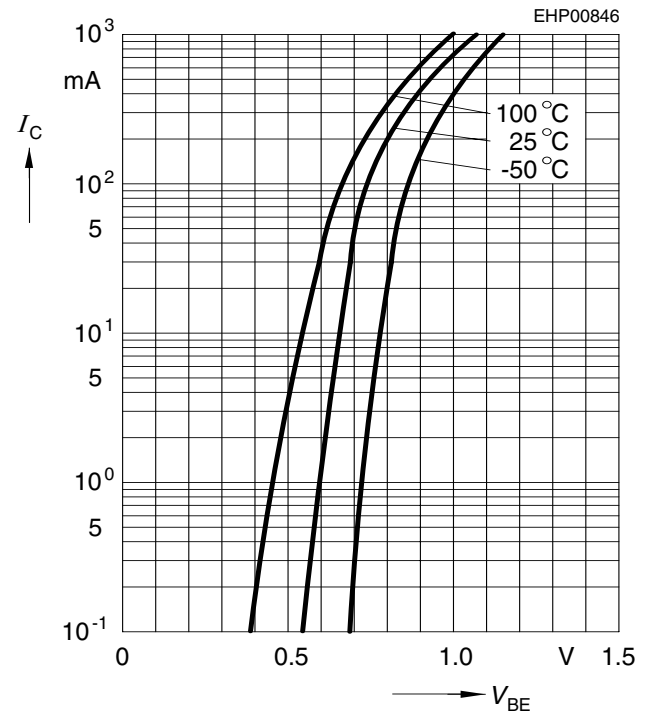

**Permissible pulse load**

$P_{totmax} / P_{totDC} = f(t_p)$

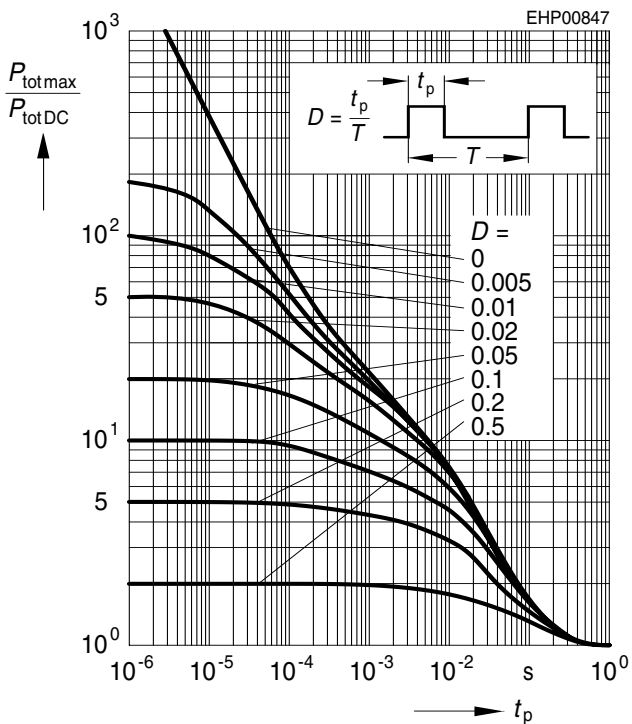

**Transition frequency  $f_T = f(I_C)$**

$V_{CE} = 5V$

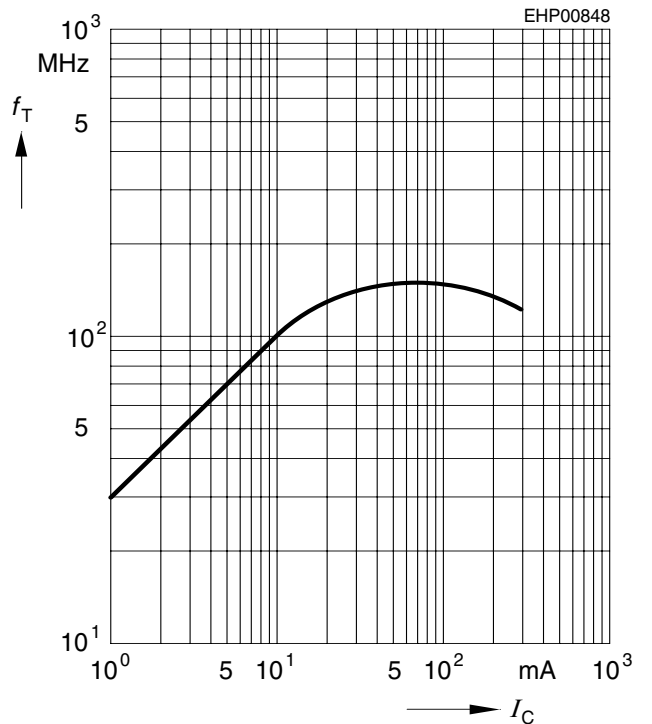

**Base-emitter saturation voltage**

$I_C = f(V_{BEsat}), h_{FE} = 10$

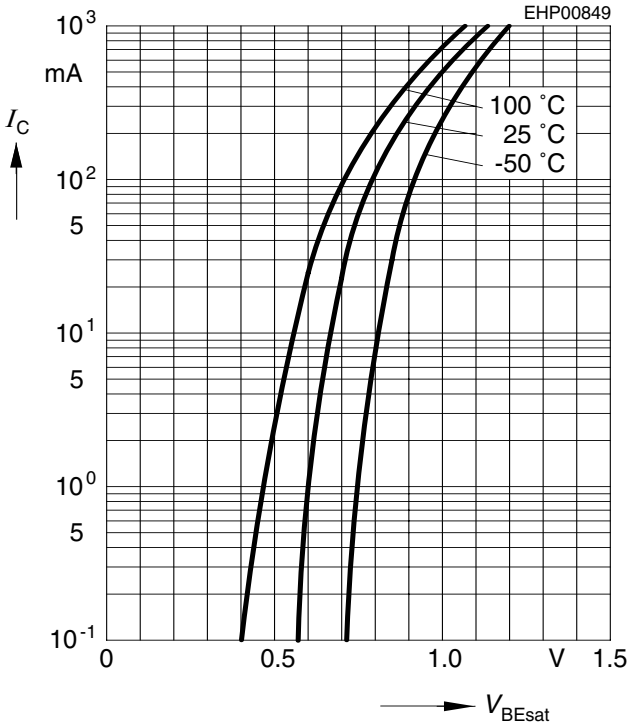

**Collector-emitter saturation voltage**

$I_C = f(V_{CEsat}), h_{FE} = 10$

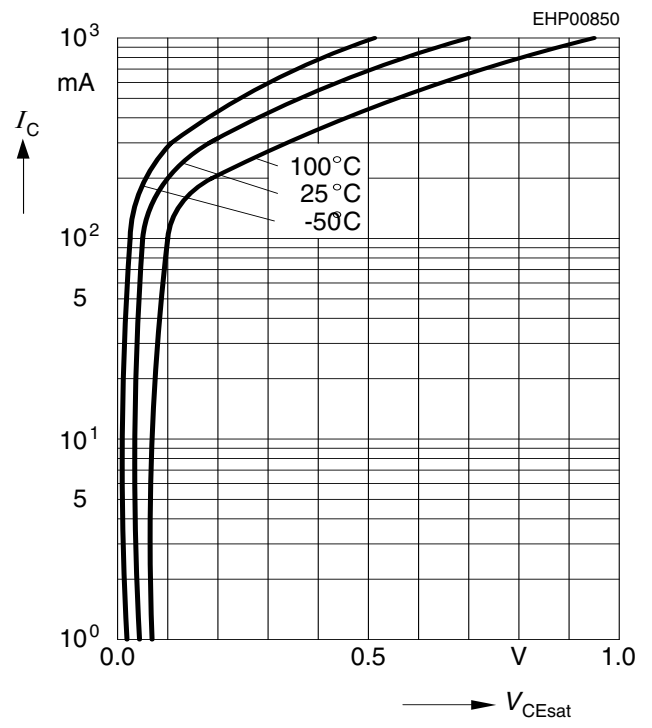

**Collector cutoff current  $I_{CBO} = f(T_A)$**

$V_{CB} = 80V$

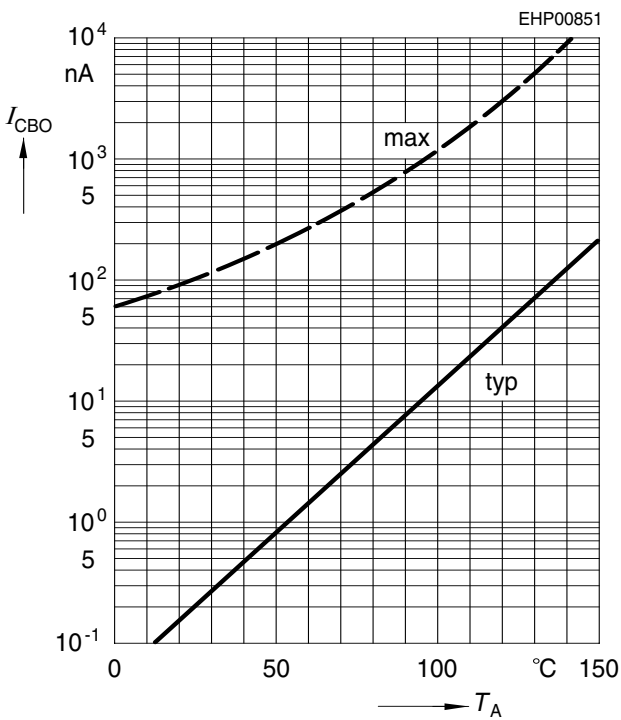

**DC current gain  $h_{FE} = f(I_C)$**

$V_{CE} = 1V$

