

**SIPMOS<sup>®</sup> Power Transistor**

- N channel
- Enhancement mode
- Avalanche-rated

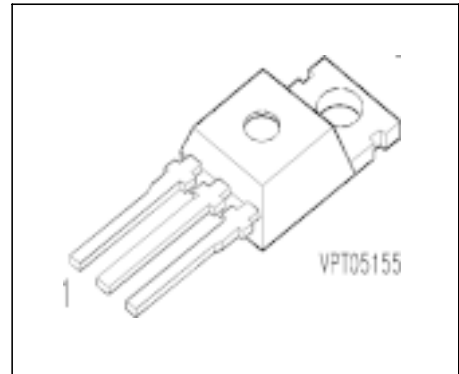

Pin 1	Pin 2	Pin 3
G	D	S

Type	V <sub>DS</sub>	I <sub>D</sub>	R <sub>DS(on)</sub>	Package	Ordering Code
BUZ 30A	200 V	21 A	0.13 Ω	TO-220 AB	C67078-S1303-A3

**Maximum Ratings**

Parameter	Symbol	Values	Unit
Continuous drain current $T_C = 26\text{ °C}$	$I_D$	21	A
Pulsed drain current $T_C = 25\text{ °C}$	$I_{Dpuls}$	84	
Avalanche current, limited by $T_{jmax}$	$I_{AR}$	21	
Avalanche energy, periodic limited by $T_{jmax}$	$E_{AR}$	12	mJ
Avalanche energy, single pulse $I_D = 21\text{ A}$ , $V_{DD} = 50\text{ V}$ , $R_{GS} = 25\text{ Ω}$ $L = 1.53\text{ mH}$ , $T_j = 25\text{ °C}$	$E_{AS}$	450	
Gate source voltage	$V_{GS}$	± 20	V
Power dissipation $T_C = 25\text{ °C}$	$P_{tot}$	125	W
Operating temperature	$T_j$	-55 ... + 150	°C
Storage temperature	$T_{stg}$	-55 ... + 150	
Thermal resistance, chip case	$R_{thJC}$	≤ 1	K/W
Thermal resistance, chip to ambient	$R_{thJA}$	75	
DIN humidity category, DIN 40 040		E	
IEC climatic category, DIN IEC 68-1		55 / 150 / 56	

**Electrical Characteristics, at  $T_j = 25^\circ\text{C}$ , unless otherwise specified**

Parameter	Symbol	Values			Unit
		min.	typ.	max.	
<b>Static Characteristics</b>					
Drain- source breakdown voltage $V_{GS} = 0\text{ V}, I_D = 0.25\text{ mA}, T_j = 25^\circ\text{C}$	$V_{(BR)DSS}$	200	-	-	V
Gate threshold voltage $V_{GS}=V_{DS}, I_D = 1\text{ mA}$	$V_{GS(th)}$	2.1	3	4	
Zero gate voltage drain current $V_{DS} = 200\text{ V}, V_{GS} = 0\text{ V}, T_j = 25^\circ\text{C}$ $V_{DS} = 200\text{ V}, V_{GS} = 0\text{ V}, T_j = 125^\circ\text{C}$	$I_{DSS}$	-	0.1 10	1 100	$\mu\text{A}$
Gate-source leakage current $V_{GS} = 20\text{ V}, V_{DS} = 0\text{ V}$	$I_{GSS}$	-	10	100	nA
Drain-Source on-resistance $V_{GS} = 10\text{ V}, I_D = 13.5\text{ A}$	$R_{DS(on)}$	-	0.1	0.13	$\Omega$

**Electrical Characteristics**, at  $T_j = 25^\circ\text{C}$ , unless otherwise specified

Parameter	Symbol	Values			Unit
		min.	typ.	max.	
<b>Dynamic Characteristics</b>					
Transconductance $V_{DS} \geq 2 \cdot I_D \cdot R_{DS(on)max}$ , $I_D = 13.5\text{ A}$	$g_{fs}$	6	15	-	S
Input capacitance $V_{GS} = 0\text{ V}$ , $V_{DS} = 25\text{ V}$ , $f = 1\text{ MHz}$	$C_{iss}$	-	1400	1900	pF
Output capacitance $V_{GS} = 0\text{ V}$ , $V_{DS} = 25\text{ V}$ , $f = 1\text{ MHz}$	$C_{oss}$	-	280	400	
Reverse transfer capacitance $V_{GS} = 0\text{ V}$ , $V_{DS} = 25\text{ V}$ , $f = 1\text{ MHz}$	$C_{rss}$	-	130	200	
Turn-on delay time $V_{DD} = 30\text{ V}$ , $V_{GS} = 10\text{ V}$ , $I_D = 3\text{ A}$ $R_{GS} = 50\ \Omega$	$t_{d(on)}$	-	30	45	ns
Rise time $V_{DD} = 30\text{ V}$ , $V_{GS} = 10\text{ V}$ , $I_D = 3\text{ A}$ $R_{GS} = 50\ \Omega$	$t_r$	-	70	110	
Turn-off delay time $V_{DD} = 30\text{ V}$ , $V_{GS} = 10\text{ V}$ , $I_D = 3\text{ A}$ $R_{GS} = 50\ \Omega$	$t_{d(off)}$	-	250	320	
Fall time $V_{DD} = 30\text{ V}$ , $V_{GS} = 10\text{ V}$ , $I_D = 3\text{ A}$ $R_{GS} = 50\ \Omega$	$t_f$	-	90	120	

**Electrical Characteristics, at  $T_j = 25^\circ\text{C}$ , unless otherwise specified**

Parameter	Symbol	Values			Unit
		min.	typ.	max.	
<b>Reverse Diode</b>					
Inverse diode continuous forward current $T_C = 25^\circ\text{C}$	$I_S$	-	-	21	A
Inverse diode direct current, pulsed $T_C = 25^\circ\text{C}$	$I_{SM}$	-	-	84	
Inverse diode forward voltage $V_{GS} = 0\text{ V}, I_F = 42\text{ A}$	$V_{SD}$	-	1.2	1.6	V
Reverse recovery time $V_R = 100\text{ V}, I_F = I_S, di_F/dt = 100\text{ A}/\mu\text{s}$	$t_{rr}$	-	180	-	ns
Reverse recovery charge $V_R = 100\text{ V}, I_F = I_S, di_F/dt = 100\text{ A}/\mu\text{s}$	$Q_{rr}$	-	1.2	-	$\mu\text{C}$

**Power dissipation**

$P_{tot} = f(T_C)$

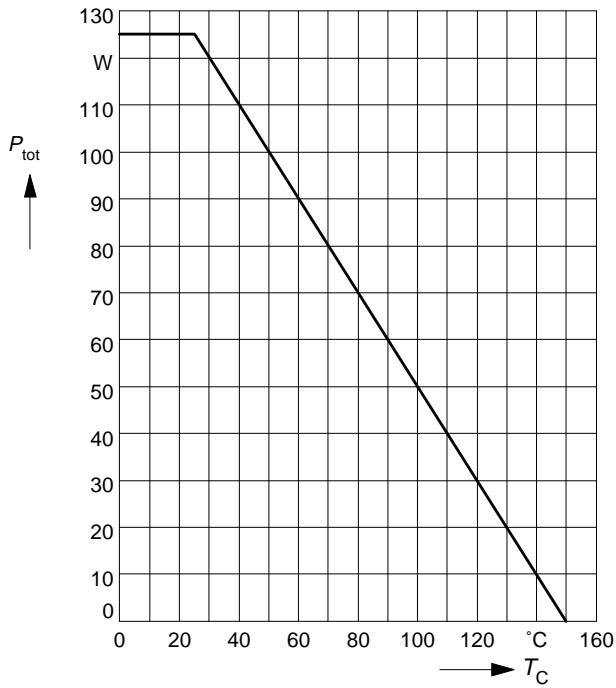

**Drain current**

$I_D = f(T_C)$

parameter:  $V_{GS} \geq 10\text{ V}$

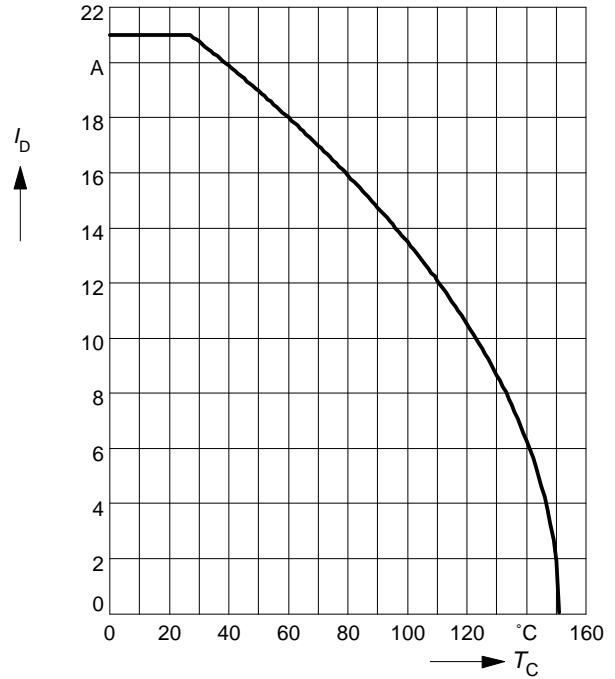

**Safe operating area**

$I_D = f(V_{DS})$

parameter:  $D = 0.01, T_C = 25^\circ\text{C}$

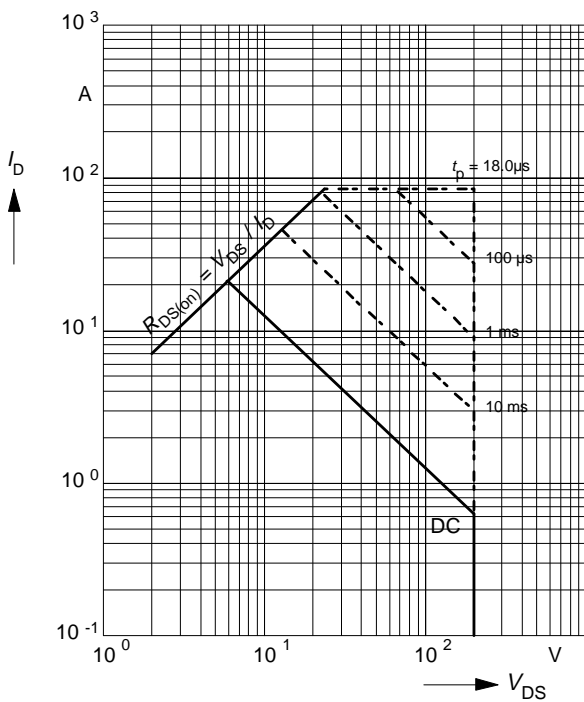

**Transient thermal impedance**

$Z_{thJC} = f(t_p)$

parameter:  $D = t_p / T$

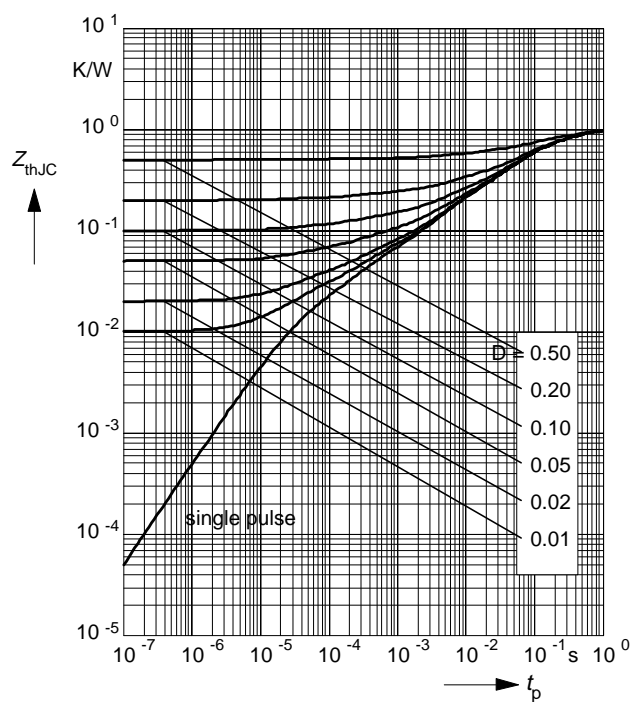

**Typ. output characteristics**

$I_D = f(V_{DS})$

parameter:  $t_p = 80 \mu s$

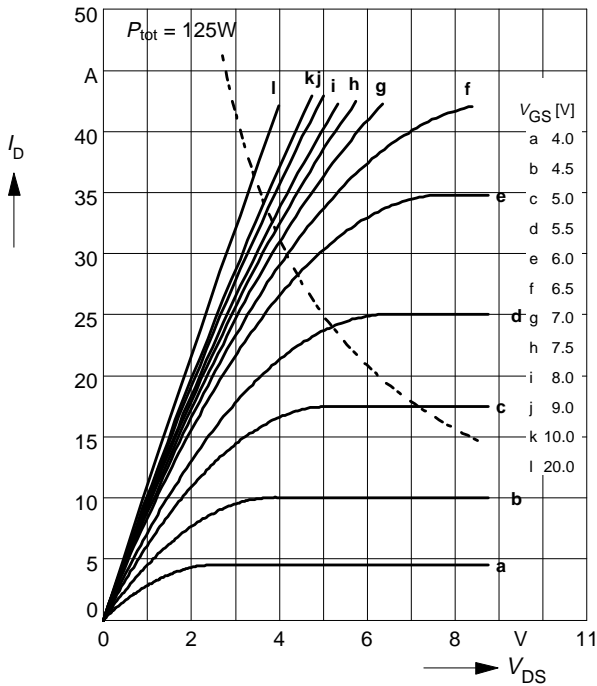

**Typ. drain-source on-resistance**

$R_{DS(on)} = f(I_D)$

parameter:  $V_{GS}$

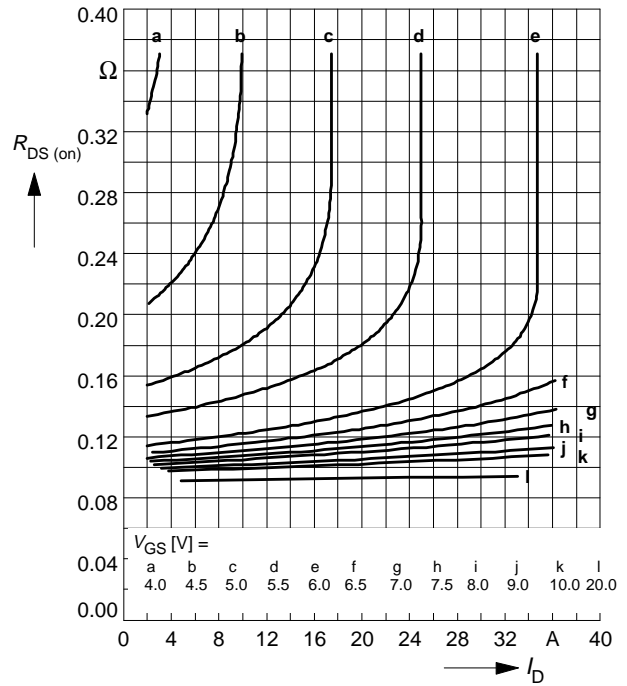

**Typ. transfer characteristics**  $I_D = f(V_{GS})$

parameter:  $t_p = 80 \mu s$

$V_{DS} \geq 2 \times I_D \times R_{DS(on)max}$

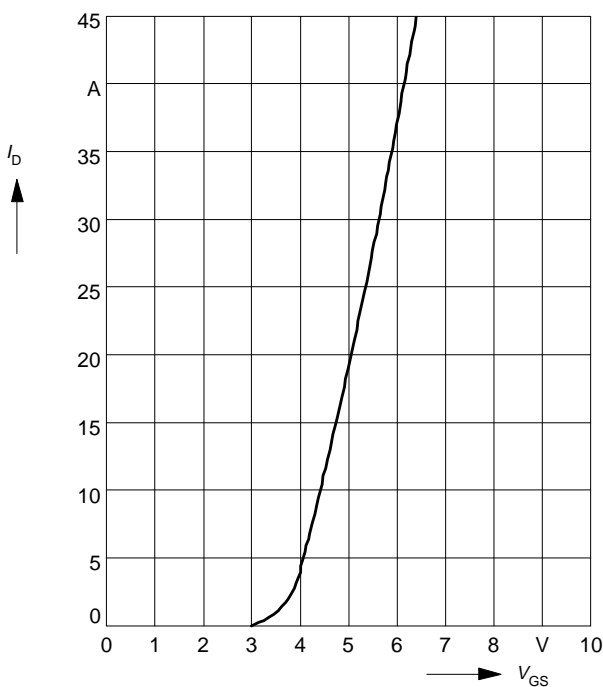

**Typ. forward transconductance**  $g_{fs} = f(I_D)$

parameter:  $t_p = 80 \mu s$ ,

$V_{DS} \geq 2 \times I_D \times R_{DS(on)max}$

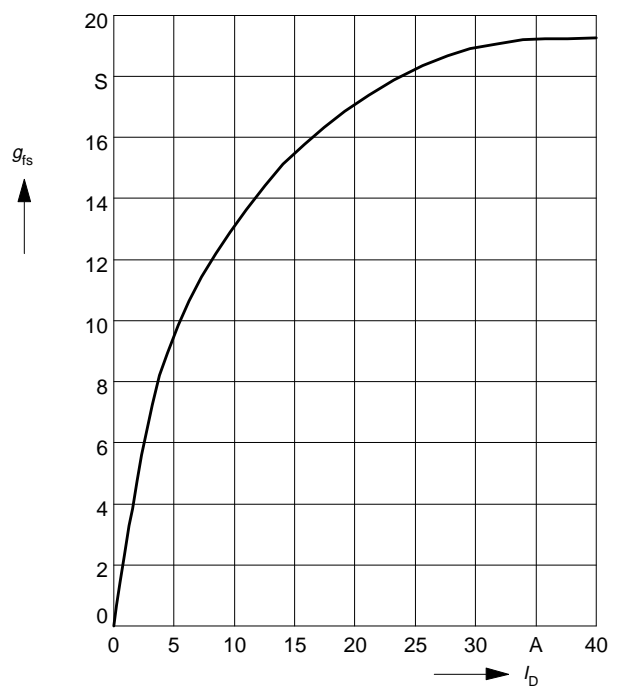

**Drain-source on-resistance**

$$R_{DS(on)} = f(T_j)$$

parameter:  $I_D = 13.5\text{ A}$ ,  $V_{GS} = 10\text{ V}$

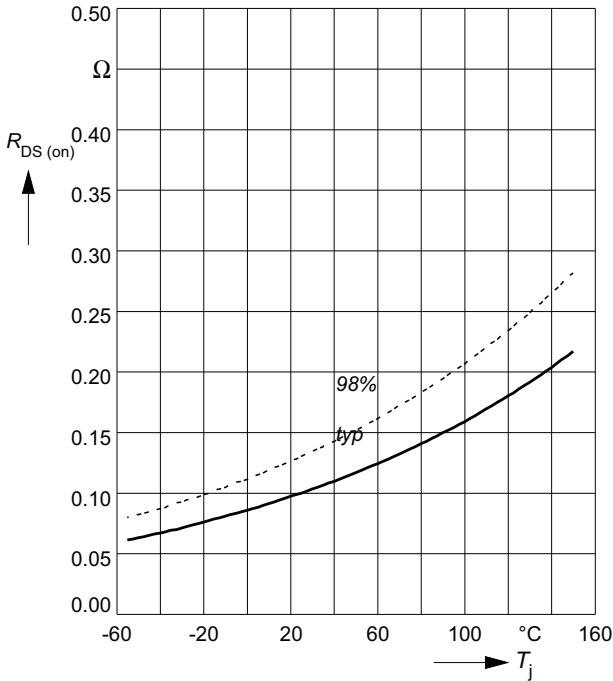

**Gate threshold voltage**

$$V_{GS(th)} = f(T_j)$$

parameter:  $V_{GS} = V_{DS}$ ,  $I_D = 1\text{ mA}$

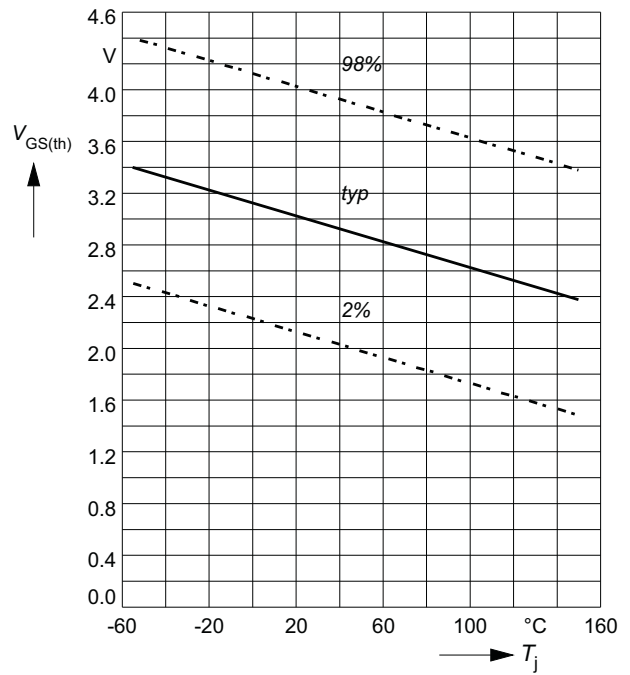

**Typ. capacitances**

$$C = f(V_{DS})$$

parameter:  $V_{GS} = 0\text{ V}$ ,  $f = 1\text{ MHz}$

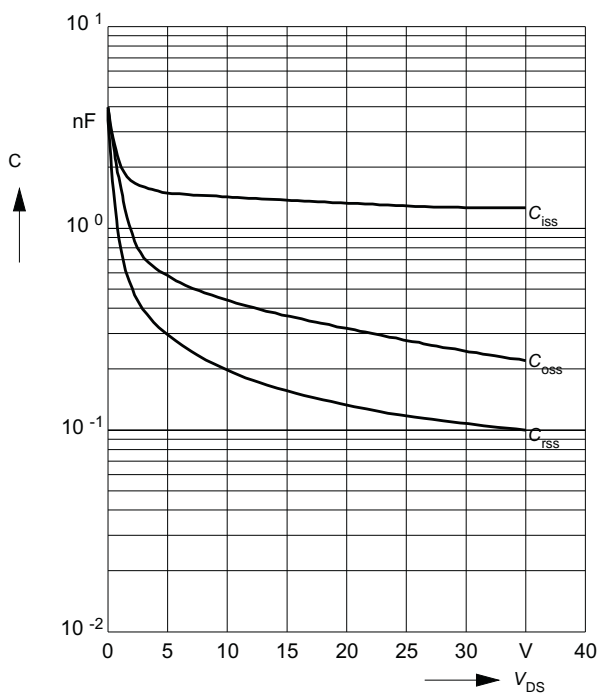

**Forward characteristics of reverse diode**

$$I_F = f(V_{SD})$$

parameter:  $T_j$ ,  $t_p = 80\text{ }\mu\text{s}$

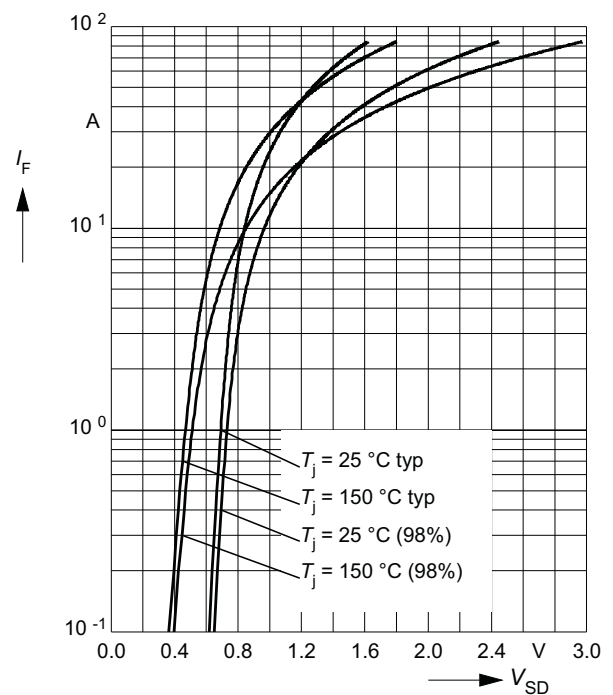

**Avalanche energy  $E_{AS} = f(T_j)$**

parameter:  $I_D = 21\text{ A}$ ,  $V_{DD} = 50\text{ V}$

$R_{GS} = 25\ \Omega$ ,  $L = 1.53\text{ mH}$

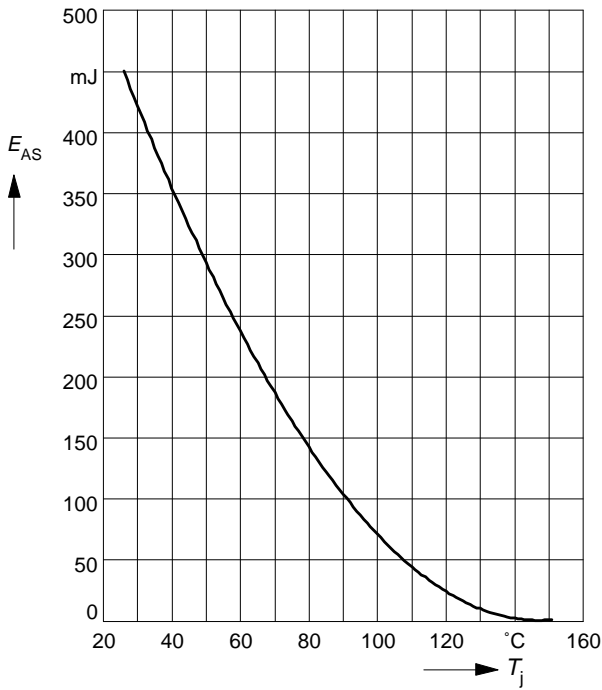

**Typ. gate charge  $V_{GS} = f(Q_{Gate})$**

parameter:  $I_{D\text{ puls}} = 32\text{ A}$

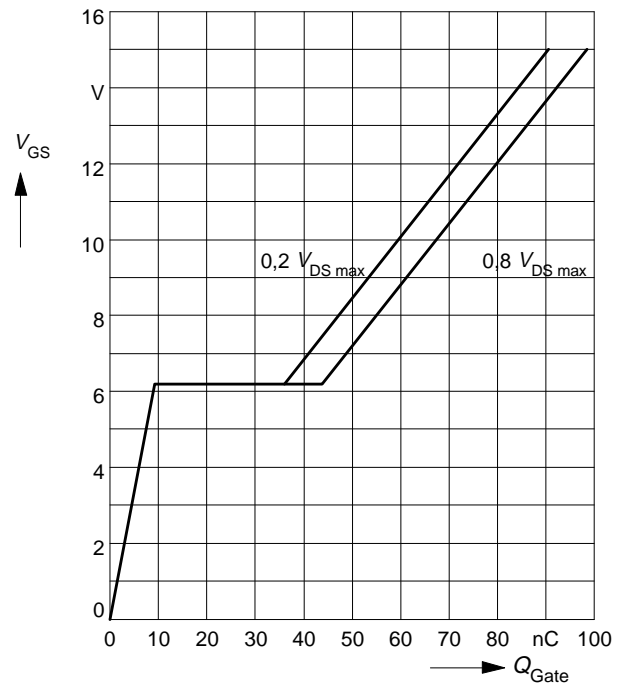

**Drain-source breakdown voltage  $V_{(BR)DSS} = f(T_j)$**

