

TINSHARP

TG12864B-03

Specification For Approval

Customer Approval: _____ Date: _____

Prepared: _____ Check: _____ Approval: _____

Date: _____ Date: _____ Date: _____

Description

REV.	DESCREPTION	DATE
V00	First issue	Dec-16-2005
V01	Update Mechanical Specifications	Apr-27-2007
V02	Update Mechanical Specifications	Sep-01-2007
V03	Add data	Nov-01-2007

CONTENTS

1. SPECIFICATIONS

- 1.1 Features
- 1.2 Block Diagram
- 1.3 Mechanical Specifications
- 1.4 Absolute Maximum Ratings
- 1.5 DC Electrical Characteristics
- 1.6 AC Characteristics
- 1.7 Electro-Optical Characteristics
- 1.8 Backlight Characteristics

2. MODULE STRUCTURE

- 2.1 Interface Pin Description
- 2.2 Operating Principles And Methods
- 2.3 Display Data RAM
- 2.4 Display Control Instruction
- 2.5 Command Detail Explain
- 2.6 MPU And Module Connection

3. RELIABILITY

- 3.1 Reliability test condition:
- 3.2 Quality Guarantee
- 3.3 Inspection method
- 3.4 Inspection Standard for Solder
- 3.5 Screen Cosmetic Criteria (Appearance)
- 3.6 Precautions for using LCM Modules
- 3.7 Installing LCM Modules
- 3.8 Precaution for Handling LCM Modules
- 3.9 Electro-Static Discharge Control
- 3.10 Precaution for soldering to the LCM
- 3.11 Precautions for operation
- 3.12 Storage
- 3.13 Safety
- 3.14 . Limited Warranty
- 3.15. Return LCM under warranty

4 . DATE CODE RULES

- 4.1 Date code for sample
- 4.2 Date code for production

1 . SPECIFICATIONS

1.1 FEATURES

Item	Contents	Unit
LCD TYPE	STN/Transmissive/Negative/Blue	--
LCD duty	1/64	--
LCD bias	1/9	--
Viewing direction	6	o'clock
Module size(W x H x T)	93.0 X 70.0 X 13.5	mm
Viewing area(W x H)	70.7 X 38.8	mm
Number of dots	128 X 64	dots
Dots size(W x H)	0.48 X 0.48	mm
Dots pitch(W x H)	0.52 X 0.52	mm

1.2. BLOCK DIAGRAM

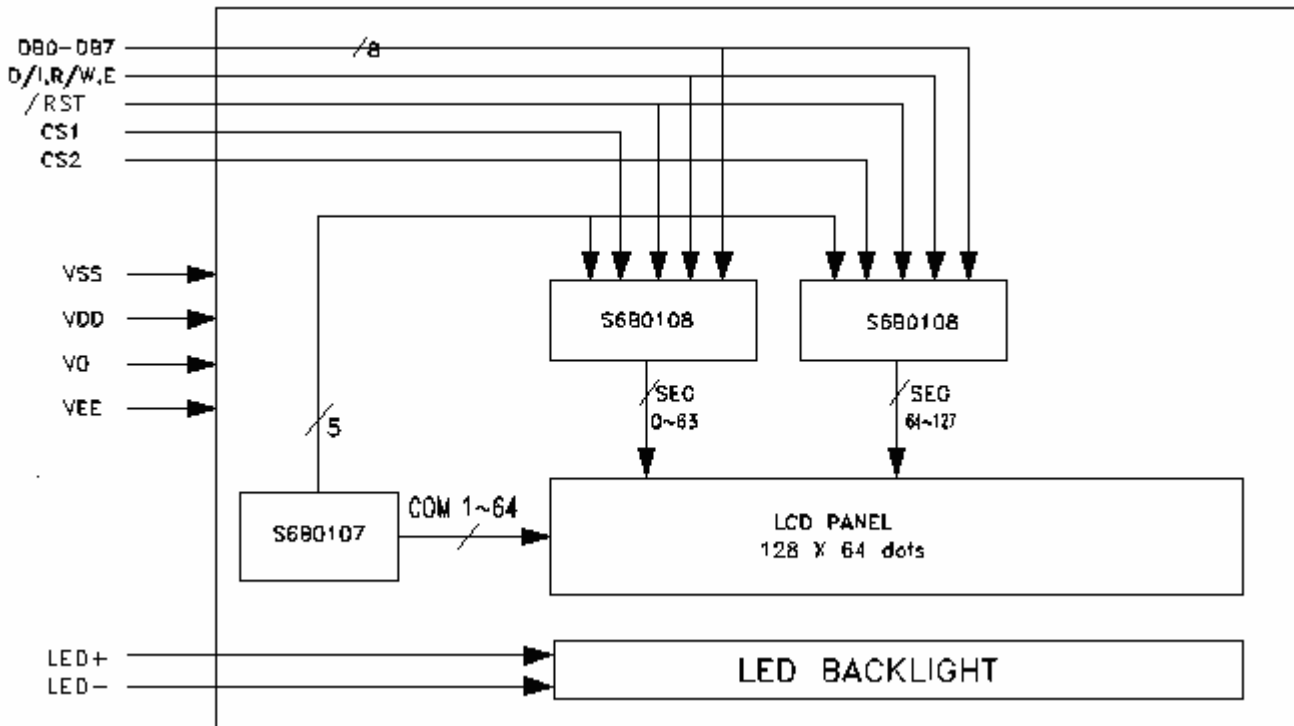

1.3 MECHANICAL SPECIFICATION

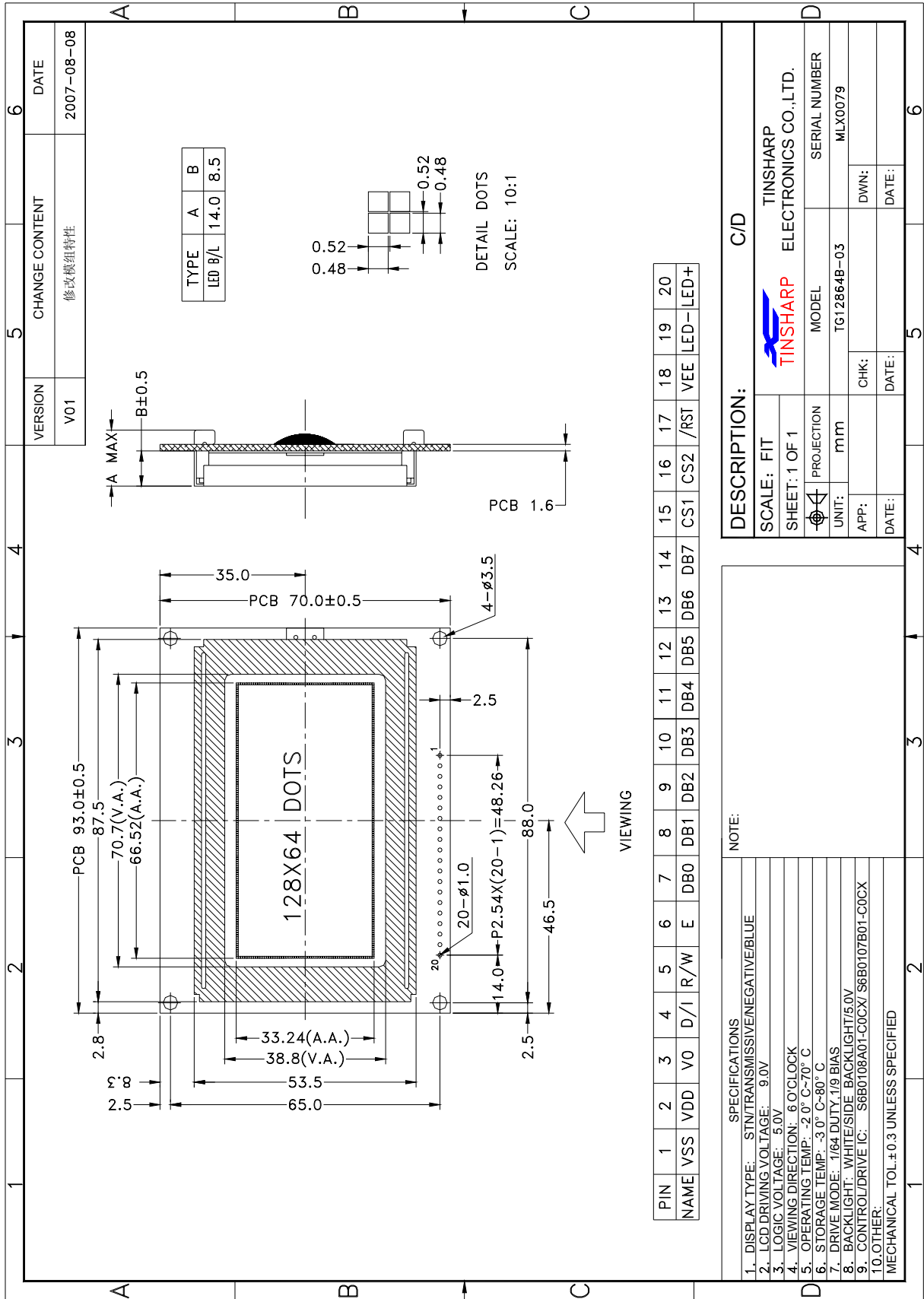

1.4 ABSOLUTE MAXIMUM RATINGS (Ta = 25°C)

Parameter	Symbol	Min	Max	Unit
Supply voltage for logic	V _{DD}	-0.3	7.0	V
Supply voltage for LCD	V _o	V _{DD} -19	V _{DD} +0.3	V
Input voltage	V _I	-0.3	V _{DD} +0.3	V
Normal Operating temperature	T _{OP}	-20	+70	°C
Normal Storage temperature	T _{ST}	-30	+80	°C

1.5 DC ELECTRICAL CHARACTERISTICS

Parameter	Symbol	Condition	Min	Typ	Max	Unit
Supply voltage for logic	V _{DD}	--	4.8	5.0	5.2	V
Supply current for logic	I _{DD}	--	--	3.5	6.0	mA
Operating voltage for LCD	V _{lcd}	25°C	8.5	9.0	9.5	V
Input voltage "H" level	V _{IH}	--	0.7 V _{DD}	--	V _{DD}	V
Input voltage "L" level	V _{IL}	--	0	--	0.3V _{DD}	V

1.6 AC CHARACTERISTICS
MPU Interface Timing

Characteristic	Symbol	Min.	Typ.	Max.	Unit
E cycle	t _{cy}	1000	---	---	ns
E high level width	t _{whE}	450	---	---	ns
E low level width	t _{wlE}	450	---	---	ns
E rise time	T _r	--	---	25	ns
E fall time	t _f	---	---	25	ns
Address set-up temp	t _{as}	140	---	---	ns
Address hold time	t _{ah}	10	---	---	ns
Data set-up time	t _{dsw}	200	---	---	ns
Data delay time	t _{ddr}	---	---	320	ns
Data hold time (write)	t _{dhw}	10	---	---	ns
Data hold time(read)	t _{dhr}	20	---	---	ns

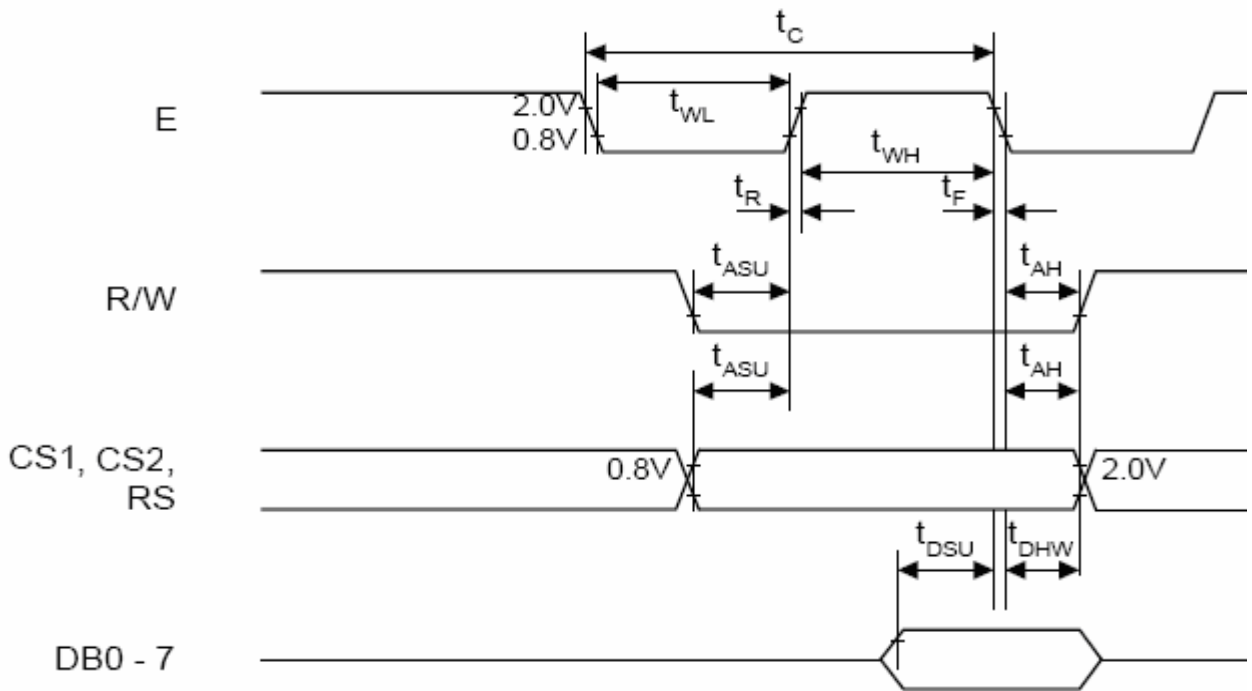

. MPU Write Timing

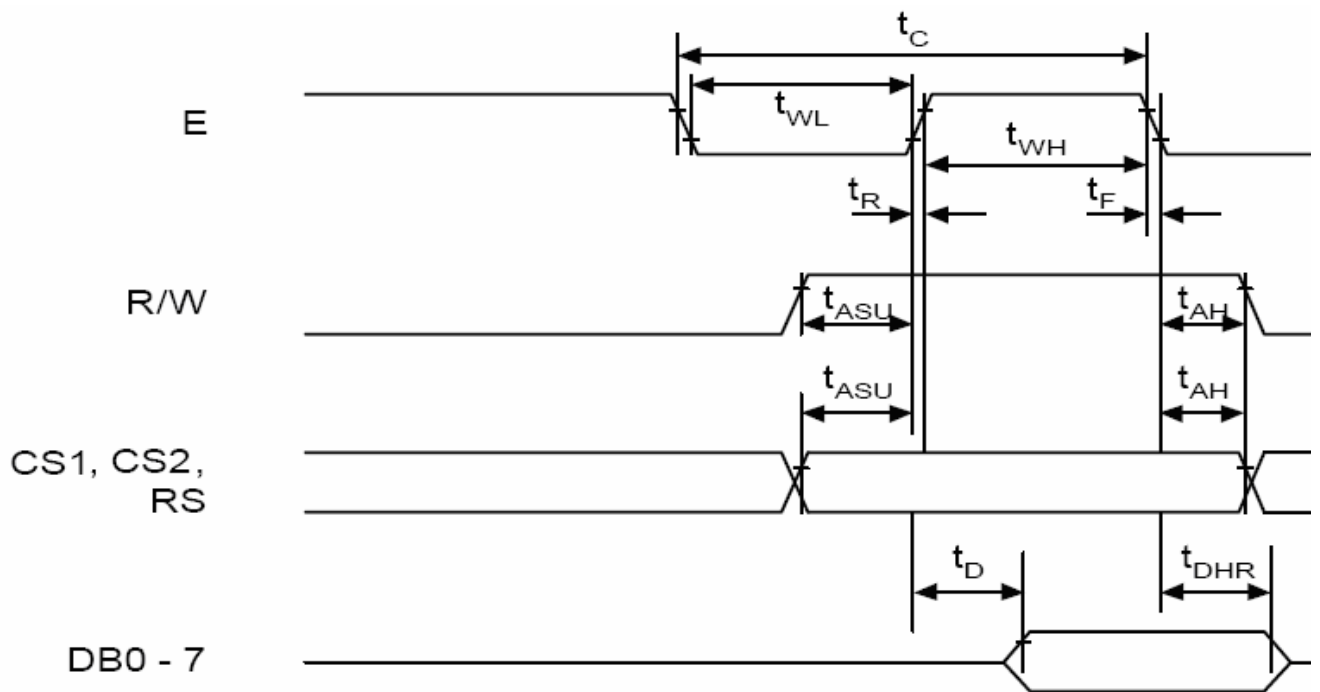

MPU Read Timing

1.7 ELECTRO-OPTICAL CHARACTERISTICS

ITEM	SYMBOL	CONDITION	MIN	TYP	MAX	UNIT	NOTE
Contrast ratio	K	$\theta=0, \Phi=0$	-	2	-		2
Response time(rise)	Tr	25°C		-	-	ms	1
Response time(fall)	Tf			-	-		1
Viewing angle	Φ	25°C		-		deg.	3
	θ			-			3

Note1: Definition of response time.

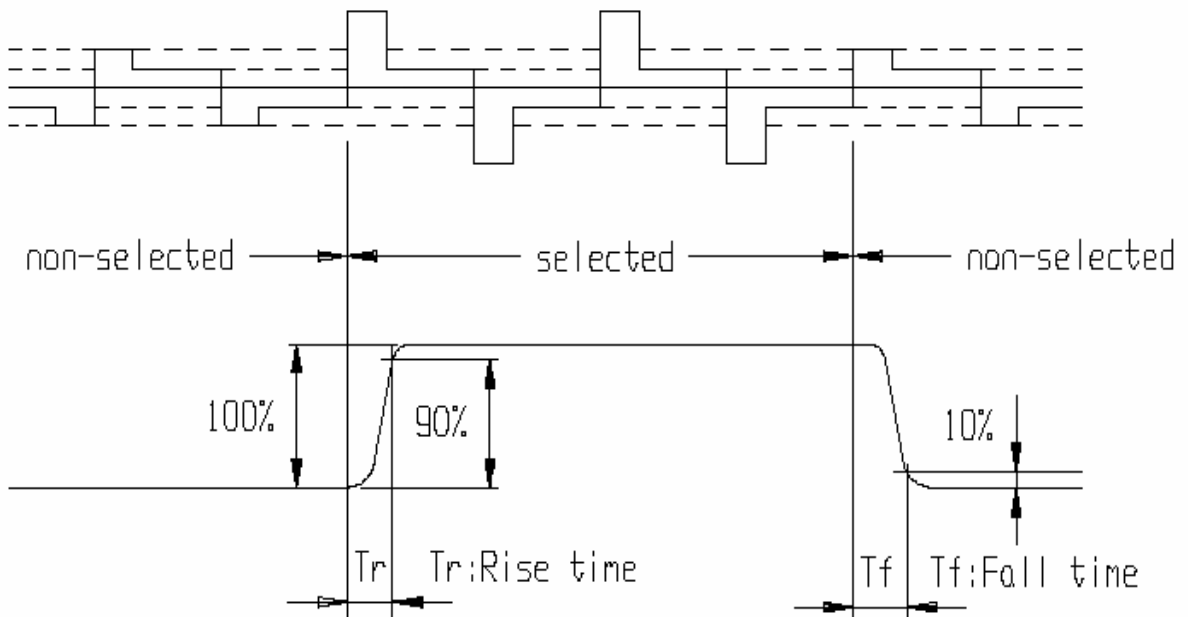

Note2: Definition of contrast ratio 'Cr' .

$$Cr = \frac{\text{Brightness of non-selected segment}(B2)}{\text{Brightness of selected segment}(B1)}$$

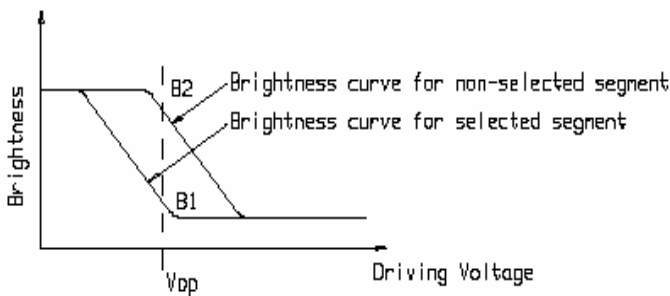

Note3: Definition of viewing angle range 'θ'.

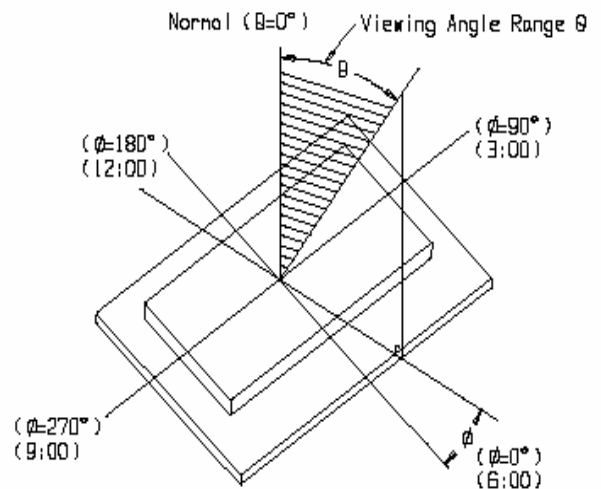

1.8 BACKLIGHT CHARACTERISTICS

1.8.1 ABSOLUTE MAXIMUM RATINGS(Ta=25°C)

Item	Symbol	Conditions	Rating	Unit
Absolute maximum forward current	Ifm		120	mA
Peak forward current	Ifp	I macc 脉冲, 1/10 占空比 I msec plus 10% Duty Cycle	360	mA
Reverse voltage	V _r		5	V
Power dissipation	P _d		612	mW
Operating Temperature Range	T _{OPr}		-20~+70°C	°C
Storage Temperature Range	T _{stg}		-30~+80°C	°C

1.8.2 ELECTRICAL –OPTICAL CHARACTERISTICS(Ta=25°C)

Item	Symbol	Min.	Typ.	Max.	Unit	Conditions
Forward Voltage	v _r	4.7	4.9	5.1	V	If = 90 mA
Reverse Current	I _r			60	uA	V _r = 5 V
Peak wave length	λ _p		white		nm	If = 90 mA

2. MODULE STRUCTURE

2.1 INTERFACE PIN DESCRIPTION

Pin No.	Symbol	Level	Description
1	VSS	0V	Ground
2	VDD	+5.0V	Supply voltage for logic operating.
3	V0	-4.8V	Adjusting LCD contrast.
4	D/I	H/L	H : Data signal, L : Instruction signal
5	R/W	H/L	H : Read mode, L : Write mode
6	E	H/L	H : Output data, L : Latches data
7	DB0	H/L	This is an 8-bit bi-directional data bus.
8	DB1	H/L	
9	DB2	H/L	
10	DB3	H/L	
11	DB4	H/L	
12	DB5	H/L	
13	DB6	H/L	
14	DB7	H/L	
15	CS1	H/L	Chip select signal for (SEG 0 - 63)
16	CS2	H/L	Chip select signal for (SEG 64-127)
17	/RST	H/L	Reset signal
18	VEE	-14.5V	Internal negative voltage output for LCD operating.
19	LED-	0	The backlight ground.
20	LED+	+5.0V	Power supply for backlight.

2.2. OPERATING PRINCIPLES AND METHODS

- **Interface Control**

1. I/O Buffer

Data is transferred through 8 data bus lines (DB0 - DB7) .

DB7 : MSB (Most significant bit)

DB0 : LSB (least significant bit)when

Data can neither be input nor output unless CS1 and CS2 are in the active mode. Therefore, When CS1 and CS2 are not in active mode it is useless to switch the signals of input Terminals except RST and ADC: that is namely, the internal state is maintained and no Instruction executes. Besides, pay attention to RST and ADC which operate irrespectively of CS1 and CS2.

2. Register

Both input register and output register are provided to interface to an MPU whose speed is Different from that of internal operation. The selection of these registers depend on the combination of R/W and D/I signals (table 1).

Table 1 Register Selection

D/I	R/W	Operation
1	1	Reads data out of output register as internal operation (display data RAM → output register)
1	0	Writes data into input register as internal operation (input register → display data RAM)
0	1	Busy check. Read of status data.
0	0	Instruction

a. Input register

The input register is used to store data temporarily before writing it into display data RAM. The data from MPU is written into the input register, then into display data RAM automatically by internal operation. When CS1 and CS2 are in the active mode and D/I and R/W select the input register as shown in table 1, data is latched at the fall of the E signal.

b. Output register

The output register is used to store data temporarily that is read from display data RAM. To read out the data from output register, CS1 and CS2 should be in the active mode and both D/I and R/W should be 1. With the read display data instruction, data stored in the output register is output while E is high level. Then, at the fall of E, the display data at the indicated address is latched into the output register and the address is increased by 1. The contents in the output register are rewritten by the read display data instruction. but read held by address set instruction, etc. Therefore, the data of the specified address cannot be output with the read display data instruction right after the address is set, but can be output at the second read of data. That is to say, one dummy read is necessary.

Figure 5 shows the CPU read timing.

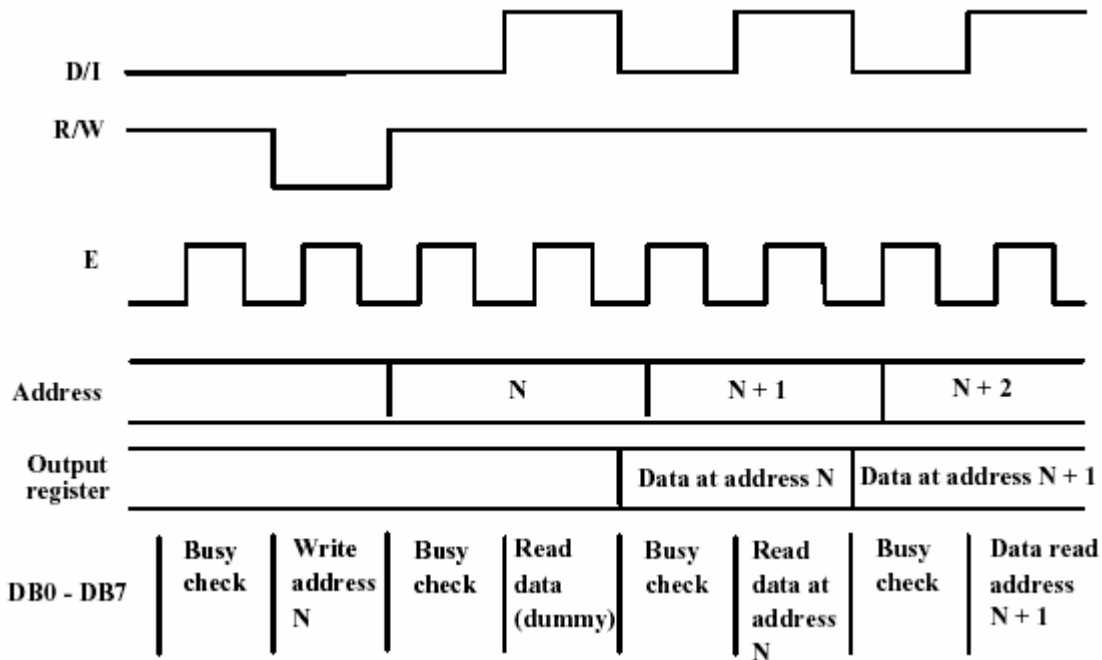
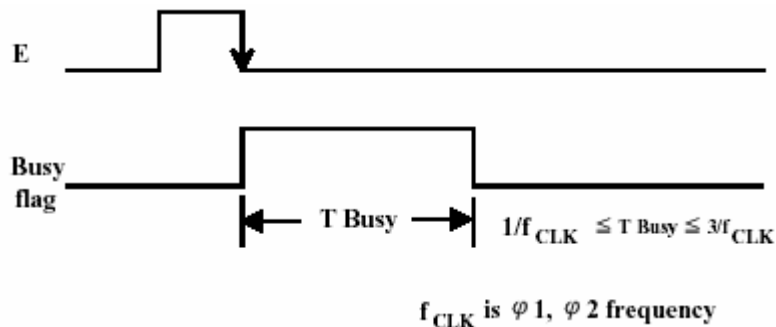

Figure 5 CPU Read Timing

• **Busy Flay**

Busy flag = 1 indicates that S6B0108 is operating and no instructions except status read instruction can be accepted. The value of the busy flag is read out on DB7 by the status read instruction. Make sure that the busy flag is reset ("0") before issuing instructions.



• **Display On/Off Flip Flop**

The display on/off flip flop selects one of two states, on state and off state of segments Y1 to Y64. In on state, the display data corresponding to that in RAM is output to the segments. On the other hand, the display data at all segments disappear in off state independent of the data in RAM. It is controlled by display on/off instruction. RST signal = 0 sets the segments in off state. The status of the flip/flop is output to DB5 by status read instruction. Display on/off instruction does not influence data in RAM. To control display data latch by this flip/flop, CL signal (display synchronous signal) should be input correctly.

2.3. DISPLAY DATA RAM

- **Display Start Line Register**

The display start line register specifies the line in RAM, which corresponds to the top line of LCD Panel, when displaying contents in display data RAM on the LCD panel. It is used for scrolling of the Screen. 6-bit display start line information is written into this register by the display start line set instruction. When high level of the FRM signal starts the display, the information in this register is transferred to the Z address counter, which controls the display address, presetting the Z address counter.

- **X, Y Address Counter**

A 9-bit counter, which designates addresses of the internal display data RAM. X address counter (upper 3 bits) and Y address counter (lower 6 bits) should be set to each address by the respective Instructions.

- (1) X address counter Ordinary register with no counts functions. An address is set by instruction.
- (2) Y address counter An address is set by instruction and is increased by 1 automatically by R/W operations of display Data The Y address counter loops the values of 0 to 63 to count.

- **Display Data RAM**

Stores dot data for display. 1-bit data of this RAM corresponds to light on (data = 1) and light off (data = 0) of 1 dot in the display panel. The correspondence between Y addresses of RAM and segment pins can be reversed by ADC signal. As the ADC signal controls the Y address counter, reversing of the signal during the operation causes malfunction and destruction of the contents of register and data of RAM. Therefore, never fail to connect ADC pin to Vcc or GND when using. Figure 6 shows the relations between Y address of RAM and segment pins in the cases of ADC = 1 and ADC = 0 (display start line = 0, 1/64 duty cycle).

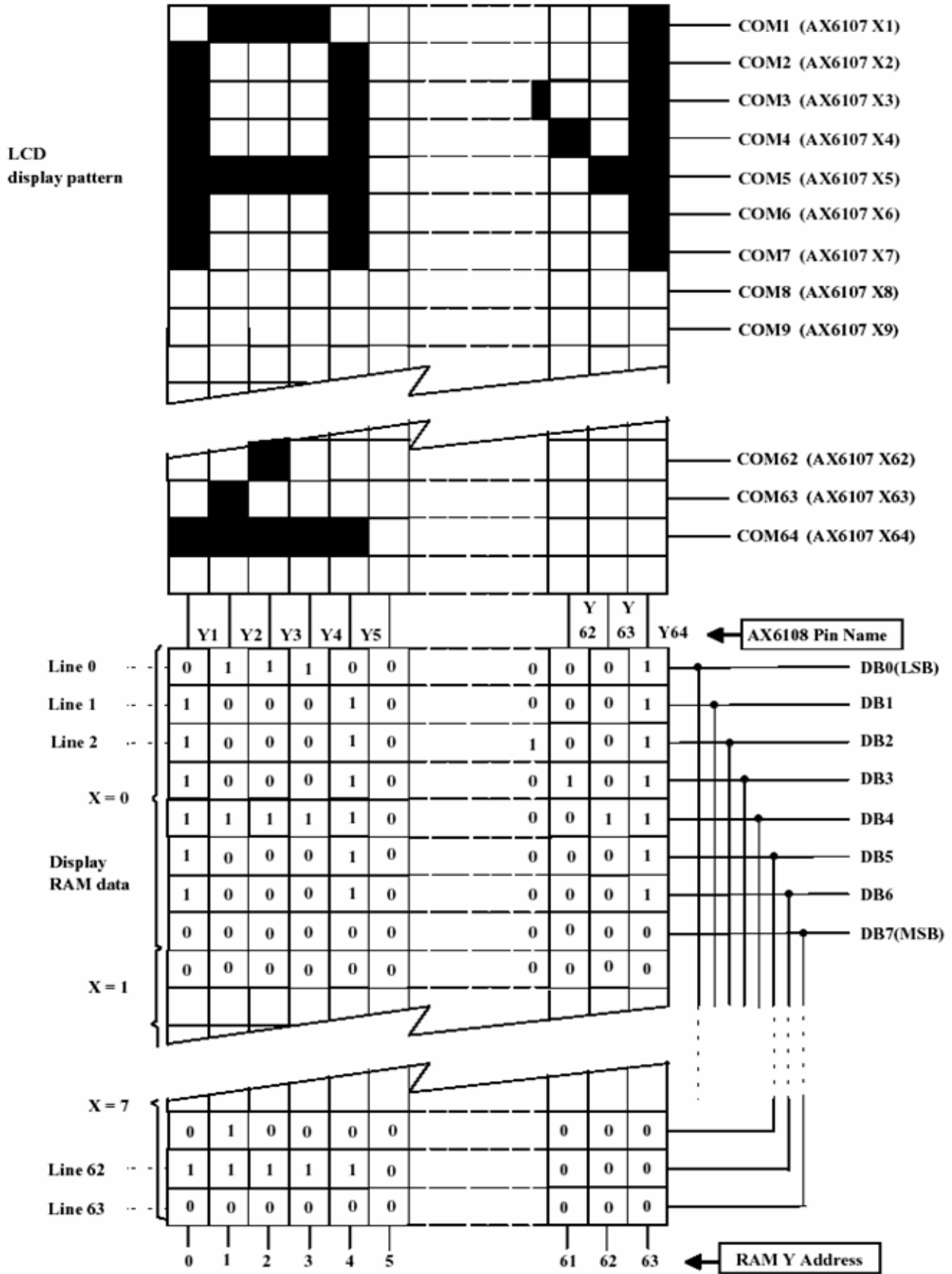

(a) ADC = 1 (Connected to Vcc)

Fig 6 Relation between RAM Data and Display

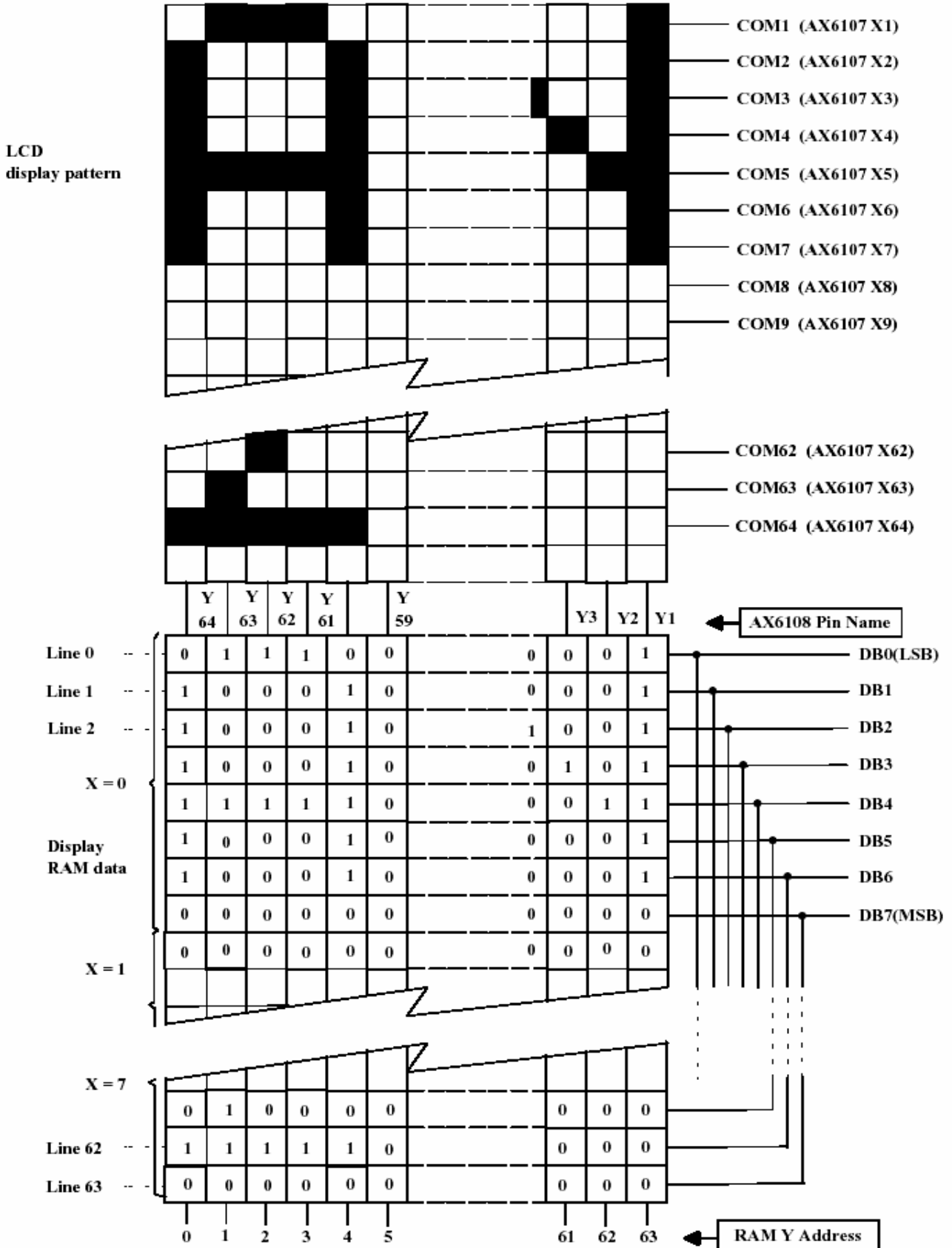

(b) ADC = 0 (Connected to GND)

Fig 6 Relation between RAM Data and Display

Z Address Counter

The Z address counter generates addresses for outputting the display data synchronized with the common signal. This counter consists of 6 bits and counts up at the fall of the CL signal. At the high level of FRM, the contents of the display start line register is preset at the Z counter.

- **Display Data Latch**

The display data latch stores the display data temporarily that is output from display data RAM to the liquid crystal driving circuit. Data is latched at the rise of the CL signal. The display on/off instruction controls the data in this latch and does not influence data in display data RAM.

- **Liquid Crystal Display Driver Circuit**

The combination of latched display data and M signal causes one of the 4 liquid crystal driver levels, V1, V2, V3 and V4 to be output.

- **Reset**

The system can be initialized by setting RST terminal at low level when turning power on.

1. Display off
2. Set display start line register line 0. While RST is low level, no instruction except status read can be accepted. Therefore, execute other instructions after making sure that DB4 = 0 (clear RESET) and DB7 = 0 (Ready) by status read instruction. The conditions of power supply at initial power up are shown in table 1.

Item	Symbol	Min	Typ	Max	Unit
Reset time	t_{RST}	1	--	--	μs
Rise time	tr	--	--	200	ns

Table 1 Power Supply Initial Conditions

Do not forget to set the system again because RESET during operation may destroy the data in all the registers except on/off register and in RAM.

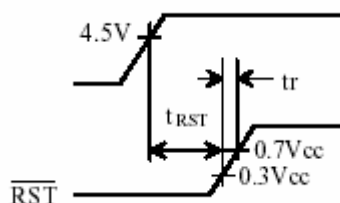

2.4. DISPLAY CONTROL INSTRUCTIONS TABLE

Table 2 shows the instructions. Read/write (R/W) signal, data/instruction (D/I) signal, and data bus signals (DB0 to DB7) are also called instructions because the internal operation depends on the signals from the MPU. These explanations are detailed in the following pages. Generally, there are following three kinds of instructions :

1. Instruction to set addresses in the internal RAM.
2. Instruction to transfer data from/to the internal RAM.
3. Other instructions. In general use, the second type of instruction is used most frequently. Since Y address of the internal RAM is increased by 1 automatically after writing (reading) data, the program can be shortened. During the execution of an instruction, the system cannot accept instructions other than status read instruction. Send instructions from MPU after making sure that the busy flag is 0, which is proof that an instruction is not being executed.

Instruction	Code										Functions	
	R/W	D/I	DB7	DB6	DB5	DB4	DB3	DB2	DB1	DB0		
Display on/off	0	0	0	0	1	1	1	1	1	1	L/O	Controls display on/off. RAM data and internal status are not affected. 1: on, 0: off.
Display start line	0	0	1	1	Display start line(0-63)							Specifies the RAM line displayed at the top of the screen.
Set page(X address)	0	0	1	0	1	1	1	Page(0~7)				Sets the page(X address) of RAM at the page(X address) register.
Set address	0	0	0	1	Y address(0-63)							Sets the Y address in the Y address counter.
Status read	1	0	B u s y	0	on / off	R e s e t	0	0	0	0		Reads the status. RESET 1: Reset 0: Normal ON/OFF 1: Display off 0: Display on Busy 1: Internal operation 0: Ready
Write display data	0	1	Write data						Writes data DB0 (LSB) to DB7 (MSB) on the data bus into display RAM.		Has access to the address of the display RAM specified in advance. After the access, Y address is increased by 1.	
Read display data	1	1	Read data						Reads DB0 (LSB) to DB7 (MSB) from the display RAM to the data bus.			
Note : 1. Busy time varies with the frequency (f CLK) of $\phi 1$ and $\phi 2$. $(1/f\text{CLK} \leq T\text{BUSY} \leq 3/f\text{CLK})$												

2.5. INSTRUCTION DETAILED EXPLAIN

(1) Display on/off

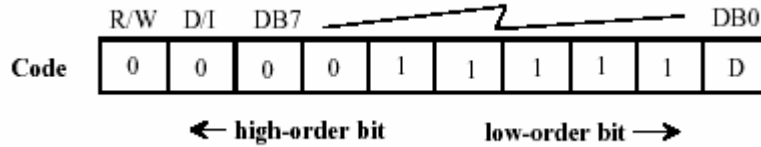

The display data appears when D is 1 and disappears when D is 0. Though the data is not on the screen with D = 0, it remains in the display data RAM. Therefore, you can make it appear by changing D = 0 into D = 1.

(2) Display start line

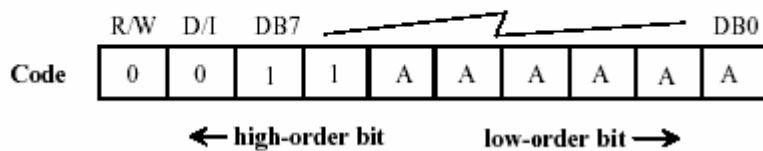

Z address AAAAAA (binary) of the display data RAM is set in the display start line register and displayed at the top of the screen. Figure 7 shows examples of display (1/64 duty cycle) when the start line = 0 - 3. When the display duty cycle is 1/64 or more (ex. 1/32, 1/24 etc.), the data of total line number of LCD screen, from the line specified by display start line instruction, is displayed.

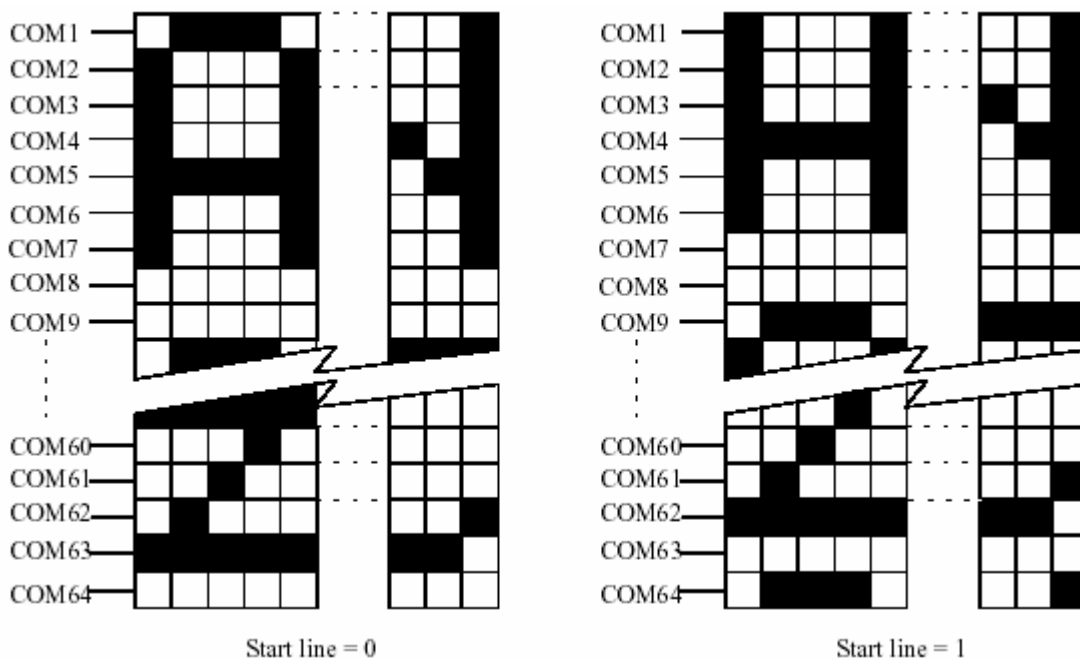

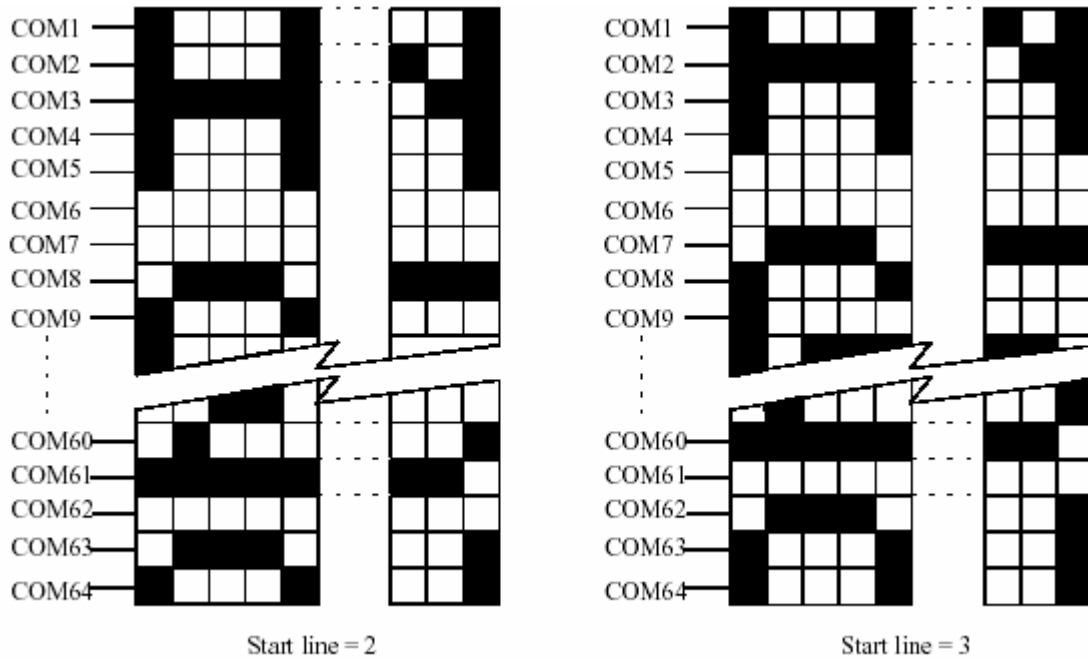

(3) Set page (X address)

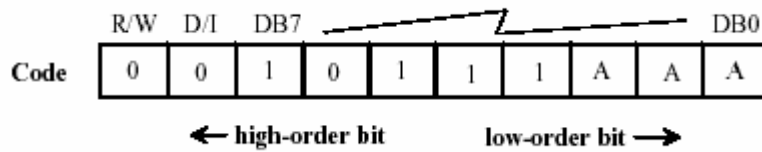

X address AAA (binary) of the display data RAM is set in the X address register. After that, writing or reading to or from MPU is executed in this specified page until the next page is set. See figure 9.

(4) Set Y address

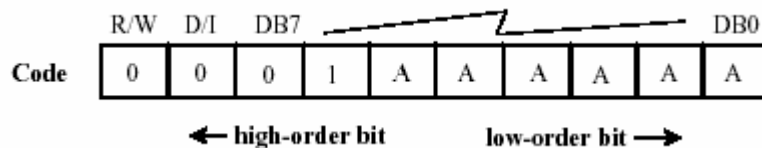

Y address AAAAAA (binary) of the display data RAM is set in the Y address counter. After that, Y address counter is increased by 1 every time the data is written or read to or from MPU.

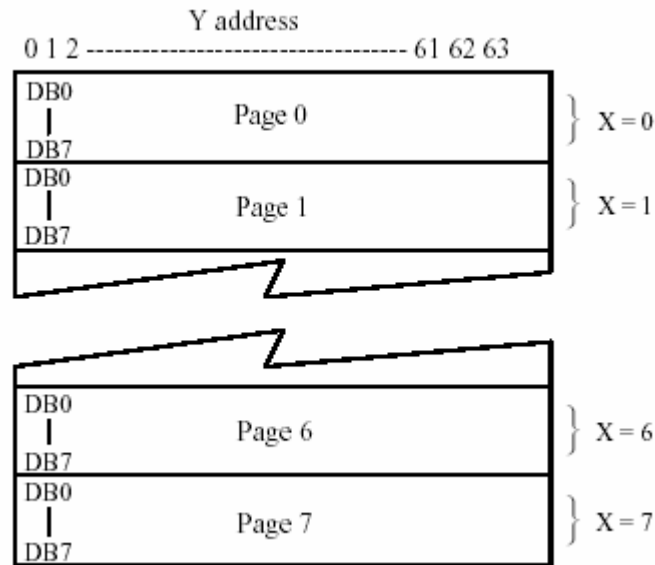
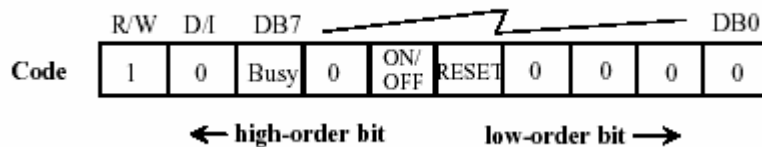

Figure 8 Address Configuration of Display Data RAM

5) Status Read



Busy : When Busy is 1, the LSI is executing internal operations. No instructions are accepted while Busy is 1, so you should make sure that Busy is 0 before writing the next instruction.

ON/OFF : Shows the liquid crystal display conditions: on condition or off condition.

When ON/OFF is 1, the display is in off condition.

When ON/OFF is 0, the display is in on condition.

RESET : RESET = 1 shows that the system is being initialized. In this condition, no instructions except status read can be accepted. RESET = 0 shows that initializing has finished and the system is in the usual operation.

(6) Write Display Data

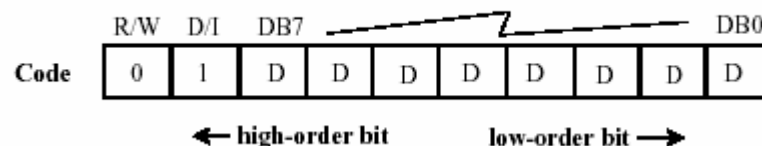

Writes 8-bit data DDDDDDDD (binary) into the display data RAM. Then Y address is increased by 1 automatically.

(7) Read Display Data

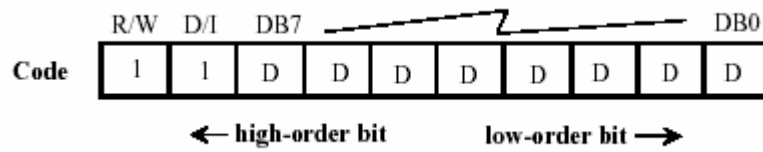

Reads out 8-bit data DDDDDDDD (binary) from the display data RAM. Then Y address is increased by 1 automatically. One dummy read is necessary soon after the address setting. For details, refer to the explanation of output register in "FUNCTION OF EACH BLOCK".

2.6. MPU AND MODULE CONNECTION

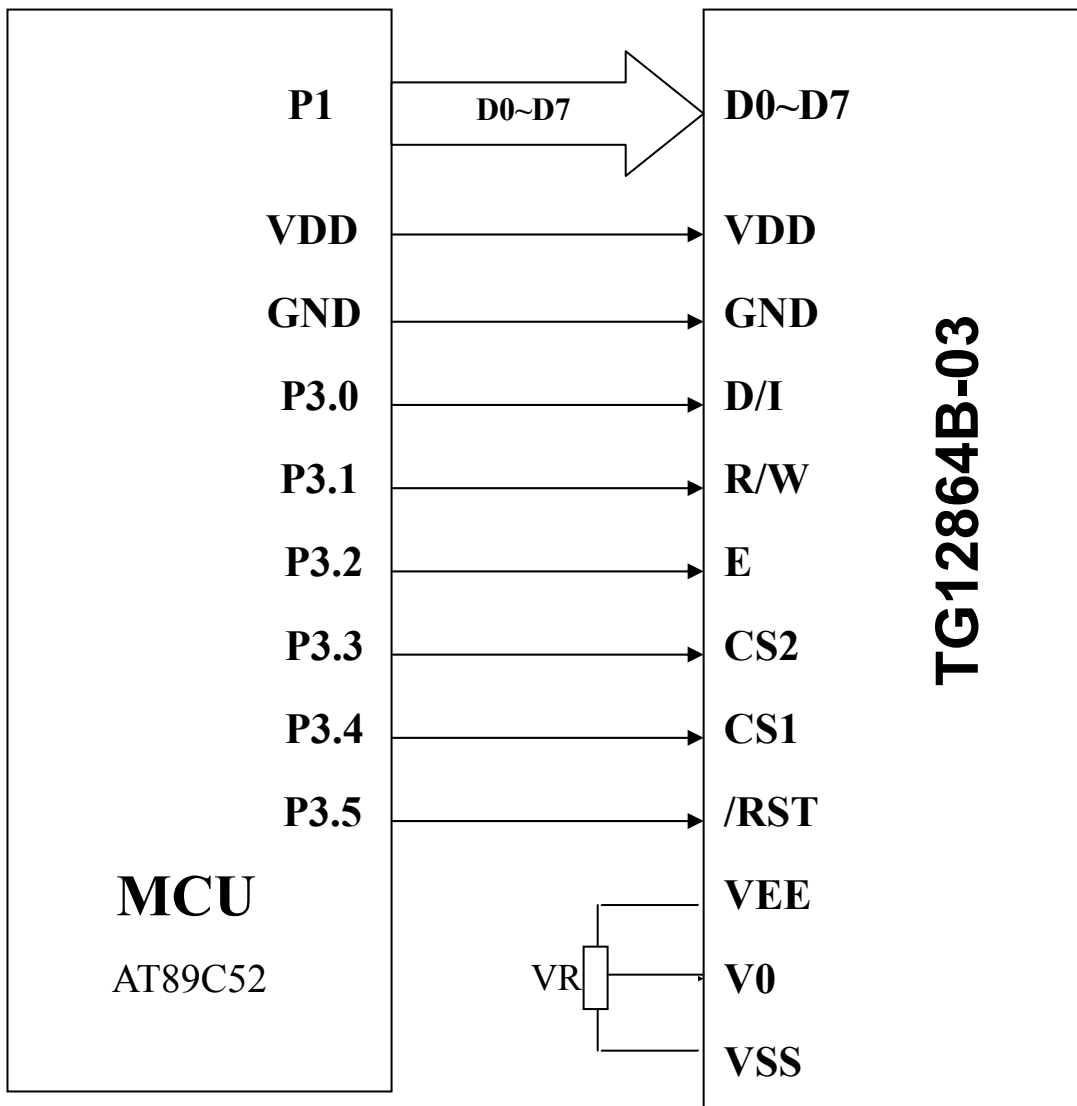

VR:20K~50K

3. RELIABILITY TEST AND QUALITY

3.1. RELIABILITY TEST CONDITION

No.	Test Item	Content of Test	Test Condition	Applicable Standard
1	High temperature storage	Endurance test applying the high storage temperature for a long time.	70°C 200 hrs	-----
2	Low temperature storage	Endurance test applying the low storage temperature for a long time.	-20°C 200 hrs	-----
3	High temperature operation	Endurance test applying the electric stress (Voltage & Current) and the thermal stress to the element for a long time.	50 °C 200 hrs	-----
4	Low temperature operation	Endurance test applying the electric stress under low temperature for a long time.	0 °C 200 hrs	-----
5	High temperature / Humidity storage	Endurance test applying the high temperature and high humidity storage for a long time.	70°C , 90 %RH 96 hrs	-----
6	High temperature / Humidity operation	Endurance test applying the electric stress (Voltage & Current) and temperature / humidity stress to the element for a long time.	40 °C , 90 %RH 96 hrs	-----
7	Temperature cycle	Endurance test applying the low and high temperature cycle. $\begin{array}{ccccc} -20^{\circ}\text{C} & \xrightarrow{30\text{min}} & 25^{\circ}\text{C} & \xrightarrow{5\text{min}} & 70^{\circ}\text{C} \\ & \xleftarrow{30\text{min}} & & \xleftarrow{5\text{min}} & \\ \leftarrow & & \text{1 cycle} & & \rightarrow \end{array}$	-20°C / 70°C 10 cycles -----	

Supply voltage for logic system = 5V. Supply voltage for LCD system = Operating voltage at 25 °C.

Mechanical Test

Vibration test	Endurance test applying the vibration during transportation and using	10~22Hz→1.5mmp-p 22~500Hz→1.5G Total 0.5hour	
Shock test	Constructional and mechanical endurance test applying the shock during transportation.	50G half sign wave 11 msede 3 times of each direction	
Atmospheric pressure test	Endurance test applying the atmospheric pressure during transportation by air	115mbar 40hrs	
Static electricity test	Endurance test applying the electric stress to the terminal	VS=800V,RS-1.5K Ω CS=100pF, 1 time	

Failure Judgment criterion

Criterion Item	Test Item No.											Failure Judgment Criterion	
	1	2	3	4	5	6	7	8	9	10	11		
Basic specification													Out of the Basic specification
Electrical characteristic													Out of the DC and AC characteristic
Mechanical characteristic													Out of the Mechanical specification Color change: out of Limit Appearance Specification
Optical characteristic													Out of the Appearance Standard

3.2. QUALITY GUARANTEE

Acceptable Quality Level, Each lot should satisfy the quality level defined as follows.

-Inspection method: MIL-STD-105E LEVEL II Normal one time sampling

AQL

Partition	AQL	Description
A: Major	0.4%	Functional defective product
B: Minor	1.5%	Satisfy all functions as product but not satisfy cosmetic standard

Definition of 'LOT'

One lot means the delivery quality to customer at once time.

Conditions of Cosmetic Inspection

. Environmental condition

The inspection should be performed at the 1 metre height from the LCD module under 2 pieces of 40W white fluorescent lamps (Normal temperature 20~25°C and normal humidity 60±15%RH).

Driving voltage

The Vo value which the most optimal contrast can be obtained near the specified Vo in the specification (Within of the typical value at 25°C.).

3.3. INSPECTION METHOD

The visual check should be performed vertically at more than 30cm distance from the LCD panel

Viewing direction for inspection is 45° from vertical against LCM.

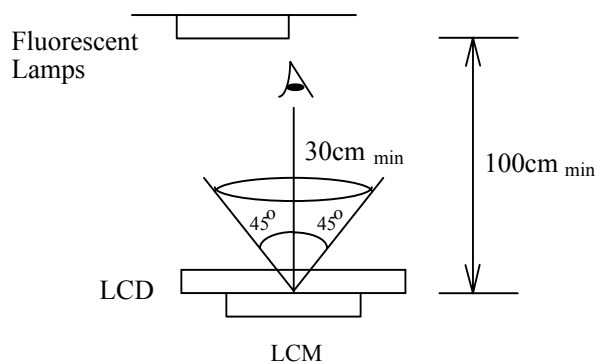

Definition of zone:

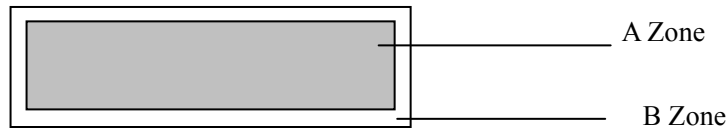

A Zone: Active display area (minimum viewing area).

B Zone: Non-active display area (outside viewing area).

3.4. INSPECTION STANDARD FOR SOLDER

Module Cosmetic Criteria

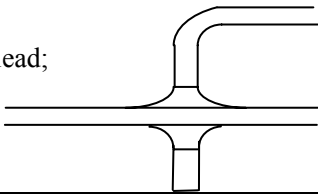
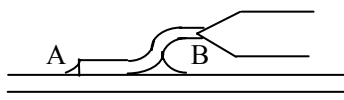
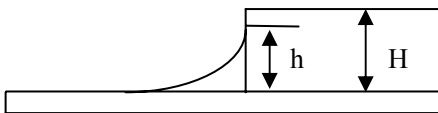
No.	Item	Judgment Criterion	Partition	
1	Difference in Spec.	None allowed	Major	
2	Pattern Peeling	No substrate pattern peeling and floating	Major	
3	Soldering defects	No soldering missing No soldering bridge No cold soldering	Major Major Minor	
4	Resist flaw on substrate	Invisible copper foil ($\Phi 0.5\text{mm}$ or more) on substrate pattern	Minor	
5	Accretion of metallic Foreign matter	No soldering dust No accretion of metallic foreign matters (Not exceed $\Phi 0.2\text{mm}$)	Minor Minor	
6	Stain	No stain to spoil cosmetic badly	Minor	
7	Plate discoloring	No plate fading, rusting and discoloring	Minor	
8	Plate discoloring	a. Soldering side of PCB	Minor	
	1. Lead parts	Solder to form a 'Filet' all around the lead; Solder should not hide the lead form perfectly too much		
	2. Flat packages	Either "toe"(A) or "heel" (B) of The lead to be covered by 'Filet' Lead form to be assume over Solder.		
3. Chips	$(3/2) H \geq h \geq (1/2) H$		Minor	

3.5. SCREEN COSMETIC CRITERIA(APPEARANCE)

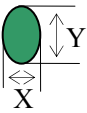
No.	Item	Criterion										
1	Short or open circuit	No allow										
	LC leakage											
	Flickering											
	No display											
	Wrong viewing direction											
	Wrong Back-light											
	Wrong or missing component											
2	Contrast defect (dim, ghost)	Refer to the approval sample										
	Background color deviation											
3	Point defect, Black spot, dust (including Polarizer) $\Phi=(X+Y)/2$	 <table border="1" data-bbox="917 862 1348 1108"> <thead> <tr> <th>Point Size</th> <th>Acceptable Qty.</th> </tr> </thead> <tbody> <tr> <td>$\phi \leq 0.10$</td> <td>Disregard</td> </tr> <tr> <td>$0.10 < \phi \leq 0.20$</td> <td>6</td> </tr> <tr> <td>$0.20 < \phi \leq 0.3$</td> <td>2</td> </tr> <tr> <td>$\phi > 0.30$</td> <td>0</td> </tr> </tbody> </table>	Point Size	Acceptable Qty.	$\phi \leq 0.10$	Disregard	$0.10 < \phi \leq 0.20$	6	$0.20 < \phi \leq 0.3$	2	$\phi > 0.30$	0
			Point Size	Acceptable Qty.								
			$\phi \leq 0.10$	Disregard								
			$0.10 < \phi \leq 0.20$	6								
			$0.20 < \phi \leq 0.3$	2								
$\phi > 0.30$	0											

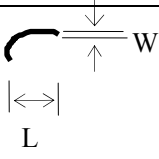
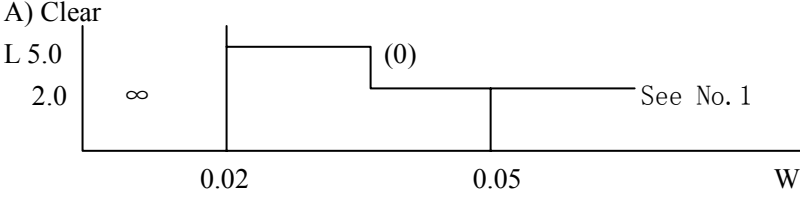
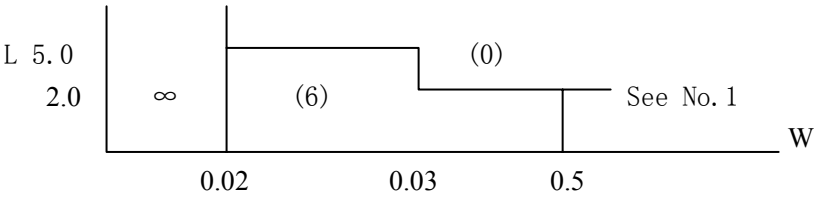
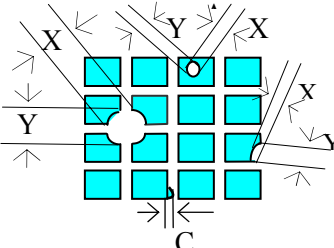
No.	Item	Criterion																			
4	<p>Line defect,</p> <p>Scratch: In accordance with spots and lines operating cosmetic criteria. When the light reflective on the panel surface, the scratches are not to be remarkable.</p>	 <table border="1" data-bbox="906 338 1458 595"> <thead> <tr> <th colspan="2">Line</th> <th rowspan="2">Acceptable Qty.</th> </tr> <tr> <th>L</th> <th>W</th> </tr> </thead> <tbody> <tr> <td>---</td> <td>$0.015 \geq W$</td> <td>Disregard</td> </tr> <tr> <td>$3.0 \geq L$</td> <td>$0.03 \geq W$</td> <td rowspan="2">2</td> </tr> <tr> <td>$2.0 \geq L$</td> <td>$0.05 \geq W$</td> </tr> <tr> <td>$1.0 \geq L$</td> <td>$0.1 > W$</td> <td>1</td> </tr> <tr> <td>---</td> <td>$0.05 < W$</td> <td>Applied as point defect</td> </tr> </tbody> </table> <p>Unit: mm</p> <p>A) Clear</p>  <p>Note: () –Acceptable Qty in active area L –Length (mm) W –Width (mm) ∞ –Disregard</p> <p>B) Unclear</p> 	Line		Acceptable Qty.	L	W	---	$0.015 \geq W$	Disregard	$3.0 \geq L$	$0.03 \geq W$	2	$2.0 \geq L$	$0.05 \geq W$	$1.0 \geq L$	$0.1 > W$	1	---	$0.05 < W$	Applied as point defect
Line		Acceptable Qty.																			
L	W																				
---	$0.015 \geq W$	Disregard																			
$3.0 \geq L$	$0.03 \geq W$	2																			
$2.0 \geq L$	$0.05 \geq W$																				
$1.0 \geq L$	$0.1 > W$	1																			
---	$0.05 < W$	Applied as point defect																			
5	Rainbow	Not more than two colors change across the viewing area																			
6	<p>Dot-matrix pattern</p> <p>$\phi = (X+Y)/2$</p>	<p>Pin hole:</p>  <table border="1" data-bbox="1007 1608 1412 1783"> <thead> <tr> <th>Size</th> <th>Acceptable Qty.</th> </tr> </thead> <tbody> <tr> <td>$\phi < 0.1$</td> <td>Disregard</td> </tr> <tr> <td>$0.10 \leq \phi \leq 0.20$</td> <td>1</td> </tr> <tr> <td>$\phi > 0.20$</td> <td>0</td> </tr> </tbody> </table> <p>C: Shall not touch other dot(s).</p>	Size	Acceptable Qty.	$\phi < 0.1$	Disregard	$0.10 \leq \phi \leq 0.20$	1	$\phi > 0.20$	0											
Size	Acceptable Qty.																				
$\phi < 0.1$	Disregard																				
$0.10 \leq \phi \leq 0.20$	1																				
$\phi > 0.20$	0																				

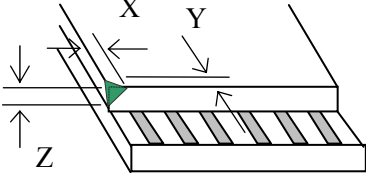
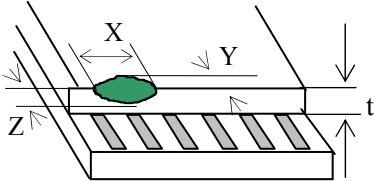
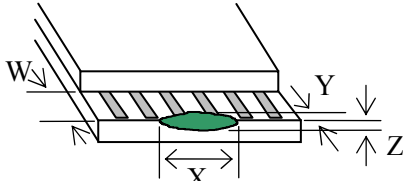
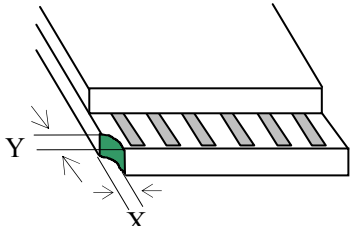
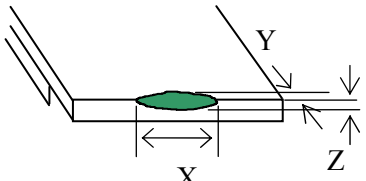
No.	Item	Criterion																																	
7	<p>Chip</p> <p>Remark:</p> <p>X: Length direction</p> <p>Y: Short direction</p> <p>Z: Thickness direction</p> <p>t: Glass thickness</p> <p>W: Terminal Width</p>	 <p>Acceptable criterion</p> <table border="1" data-bbox="932 427 1337 517"> <thead> <tr> <th>X</th> <th>Y</th> <th>Z</th> </tr> </thead> <tbody> <tr> <td>≤ 2</td> <td>0.5mm</td> <td>$\leq t$</td> </tr> </tbody> </table>  <p>Acceptable criterion</p> <table border="1" data-bbox="932 707 1326 797"> <thead> <tr> <th>X</th> <th>Y</th> <th>Z</th> </tr> </thead> <tbody> <tr> <td>≤ 2</td> <td>0.5mm</td> <td>$\leq t/2$</td> </tr> </tbody> </table>  <p>Acceptable criterion</p> <table border="1" data-bbox="948 1077 1353 1167"> <thead> <tr> <th>X</th> <th>Y</th> <th>Z</th> </tr> </thead> <tbody> <tr> <td>Disregard</td> <td>≤ 0.2</td> <td>$\leq t$</td> </tr> </tbody> </table>  <p>Acceptable criterion</p> <table border="1" data-bbox="940 1335 1331 1469"> <thead> <tr> <th>X</th> <th>Y</th> <th>Z</th> </tr> </thead> <tbody> <tr> <td>≤ 3</td> <td>≤ 2</td> <td>$\leq t$</td> </tr> <tr> <td colspan="2">shall not reach to ITO</td> <td></td> </tr> </tbody> </table>  <p>Acceptable criterion</p> <table border="1" data-bbox="943 1671 1315 1760"> <thead> <tr> <th>X</th> <th>Y</th> <th>Z</th> </tr> </thead> <tbody> <tr> <td>≤ 5</td> <td>≤ 2</td> <td>$\leq t/3$</td> </tr> </tbody> </table>	X	Y	Z	≤ 2	0.5mm	$\leq t$	X	Y	Z	≤ 2	0.5mm	$\leq t/2$	X	Y	Z	Disregard	≤ 0.2	$\leq t$	X	Y	Z	≤ 3	≤ 2	$\leq t$	shall not reach to ITO			X	Y	Z	≤ 5	≤ 2	$\leq t/3$
X	Y	Z																																	
≤ 2	0.5mm	$\leq t$																																	
X	Y	Z																																	
≤ 2	0.5mm	$\leq t/2$																																	
X	Y	Z																																	
Disregard	≤ 0.2	$\leq t$																																	
X	Y	Z																																	
≤ 3	≤ 2	$\leq t$																																	
shall not reach to ITO																																			
X	Y	Z																																	
≤ 5	≤ 2	$\leq t/3$																																	

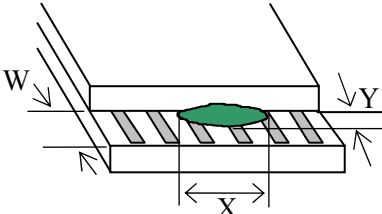
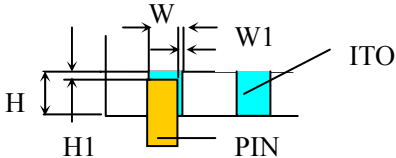
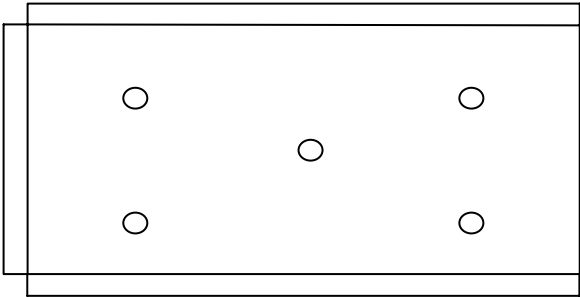
No.	Item	Criterion
8	Total no. of acceptable Defect	<p>A. Zone</p> <p>Maximum 2 minor non-conformities per one unit. Defect distance: each point to be separated over 10mm</p> <p>B. Zone</p> <p>It is acceptable when it is no trouble for quality and assembly in customer's end product.</p>
9	Protruded W: Terminal Width	 <p>Acceptable criteria: $Y \leq 0.4$</p>
10	PIN	<p>Position</p>  <div style="border: 1px solid black; padding: 5px; width: fit-content;"> $W1 \leq 1/3W$ $H1 \leq 1/3H$ </div>
11	Uneven brightness (only back-lit type module)	<p>Uneven brightness must be $B_{MAX}/B_{MIN} \leq 2$</p> <p>-B_{MAX} : Max. value by measure in 5 points -B_{MIN} : Min. value by measure in 5 points</p> <p>Divide active area into 4 vertically and horizontally. Measure 5 points shown in the following figure</p> 
12	Allowable density	Above defects should be separated more than 10mm each other.
13	Rubbing line	Not to be noticeable.
14	Dot size	<p>To be 95% ~ 105% of the dot size (typ.) in drawing, Partial defects of each dot (ex. Pin-hole) should be treated as 'spot'.(see Screen Cosmetic Criteria (operating) No.)</p>

No.	Item	Criterion	
15	Bubbles in polarizer	Size : d mm	Acceptable Qty in active area
		$d \leq 0.3$	Disregard
		$0.3 < d \leq 1.0$	3
		$1.0 < d \leq 1.5$	1
		$1.5 < d$	0
16	Allowable density	Above defects should be sea rated more than 30mm each other	
17	Coloration	Not to be noticeable coloration in the viewing area of the LCD panels. Backlit type should be judged with back-lit on state only.	
18	Contamination	Not to be noticeable.	

Note:

‘Clear’= the shade and size are not changed by Vo.

‘Unclear’= the shade and size are changed by V0.

Size: $d = (\text{long length} + \text{short length}) / 2$

The limit samples for each item have priority

Completed defects are defined item by item, but if the number of defects is defined in above table, the total number should not exceed 10.

In case of ‘concentration’, even the spots or the lines of ‘disregarded size should not allowed. Following three situations Should be treated as ‘concentration’.

-7 or over defects in circle of $\Phi 2\text{mm}$

-10 or over defects in circle of $\Phi 10\text{mm}$

-20 or over defects in circle of $\Phi 20\text{mm}$

3.6. PRECAUTIONS FOR USING LCM MODULES

1. Liquid Crystal Display Modules

LCD is composed of glass and polarizer. Pay attention to the following items when handing.

- (1) Please keep the temperature within specified range for use and storage. Polarization degradation, bubble generation or Polarizer peel-off may occur with high humidity.
- (2) Do not touch, push or rub the exposed polarizer with anything harder than an HB Pencil lead (Glass, tweezers, etc.).
- (3) N-hexane is recommended for cleaning the adhesives used to attach front/rear polarizers and reflectors made of organic, substances which will be damaged by chemicals such as acetone, toluene, ethanol and isopropyl alcohol.
- (4) When the display surface becomes dusty, wipe gently with absorbent cotton or other soft material like chamois soaked in petroleum Benin. Do not scrub hard to avoid damaging the display surface.
- (5) Wipe off saliva or water drops immediately, contact with water over a long period of time may cause deformation or color fading.
- (6) Avoid contacting oil and fats.
- (7) Condensation on the surface and contact with terminals due to cold will damage, stain or dirty the polarizers. After products are tested at low temperature the must be warmed up in a container before coming is contacting temperature air.

- (8) Do not put or attach anything on the display area to avoid leaving marks on.
- (9) Do not touch the display with bare hands. This will stain the display and degrade insulation between terminals (some cosmetics are determinate to the polarizer).
- (10) As glass is fragile. It tends to become or chipped during handling especially on the edges. Please avoid dropping or jarring.

3.7. INSTALLING LCM MODULES

The hole in the printed circuit board is used to fit LCM as shown in the picture below. Attend to the following items when installing the LCM

- (1) Cover the surface with a transparent protective plate to protect the polarizer and LC cell.

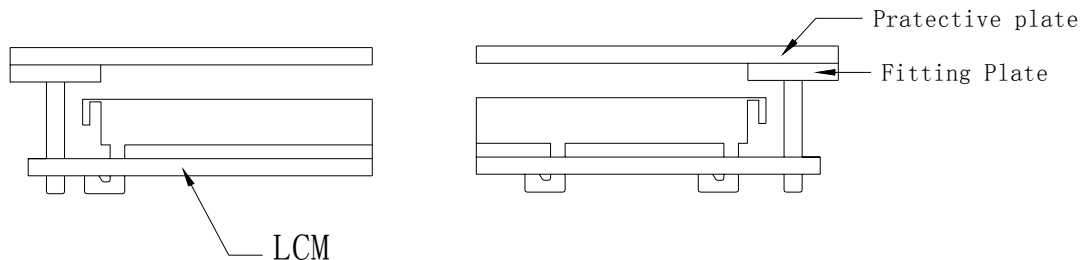

- (2) When assembling the LCM into other equipment, the spacer to the bit between the LCM and the fitting plate should have enough height to avoid causing stress to the module surface, refer to the individual specifications for measurements. The measurement tolerance should be $\pm 0.1\text{mm}$

3.8. PRECAUTION FOR HANDING LCM MODULE

Since LCM has been assembled and adjusted with a high degree of precision, avoid applying excessive shocks to the module or making any alterations or modifications to it.

- (1) Do not alter, modify or change shape of the tab on the metal frame
- (2) Do not make extra holes on the printed circuit board, modify its shape or change the positions of components to be attached.
- (3) Do not damage or modify the pattern writing on the printed circuit board.
- (4) Absolutely do not modify the zebra rubber strip (conductive rubber) or heat seal connector.
- (5) Except for soldering the interface, do not make any alterations or modifications with a soldering iron.
- (6) Do not drop, bend or twist LCM

3.9. ELECTRO-STATIC DISCHARGE CONTROL

Since this module uses a CMOS LSI, the same attention should be paid to electrostatic discharge as for an ordinary CMOS IC.

- (1) Make certain that you are grounded when handing LCM.
- (2) Before remove LCM from its packing case or incorporating it into a set, be sure the module and your body have the same electric potential.
- (3) When soldering the terminal of LCM, make certain the AC power source for the soldering iron does not leak.
- (4) When using an electric screwdriver to attach LCM, the screwdriver should be of ground potentiality to minimize as much as possible any transmission of electromagnetic waves produced sparks coming from the commutation of the motor.
- (5) As far as possible make the electric potential of your work clothes and that of the workbench the ground potential.
- (6) To reduce the generation of static electricity be careful that the air in the work is not too dried. A relative humidity of 50%-60% is recommended.

3.10. PRECAUTION FOR SOLDERING TO THE LCM

- (1) Observe the following when soldering lead wire , connector cable and etc. to the LCM
 - Soldering iron temperature: 280°C±10°C
 - Soldering time: 3-4 seconds
 - Solder: eutectic solder.

If soldering flux is used, be sure to remove any remaining flux after finishing to soldering operation.(This does not apply in the case of non-halogen type of flux.) It is recommended that you protect the LCD surface with a cover during soldering to prevent any damage due to flux spatters.

- (2) When soldering the electro-luminescent panel and PC board, the panel and board should not be detached more than three times, This maximum number is determined by the temperature and time conditions mentioned above, though there may be some variance depending on the temperature of the soldering iron.
- (3) When remove the electro-luminescent panel from the PC board, be sure the solder has completely melted, the soldered pad on the PX board could be damaged.

3.11. PRECAUTIONS FOR OPERATION

- (1) Viewing angle varies with the change of liquid crystal driving voltage (V₀). Adjust V₀ to show the best contrast.
- (2) Driving the LCD in the voltage above the limit shortens its life.
- (3) Response time is greatly delayed at temperature below the operating temperature range. However, this does not mean the LCD cell be out of the order. It will recover when it returns to the specified temperature range.
- (4) If the display area is pushed hard during operation, the display will become abnormal, however, it will return to normal. If it is turned off and then back on. Used under the relative condition of 40°C, 50%RH.
- (5) When turning the power on input each signal after the positive/negative voltage becomes stable.

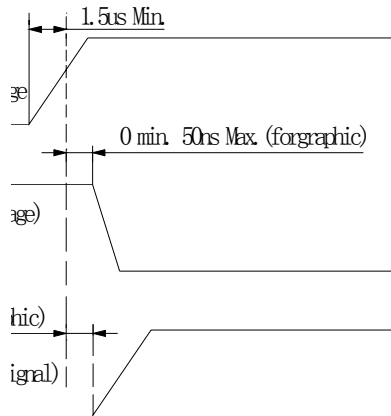

3.12. STORAGE

When storing LCD as spares for some years, the following precautions are necessary.

- (1) Store them in a sealed polyethylene bag. If properly sealed, there is no need for dessicant.
- (2) Store them in a dark place. Do not expose to sunlight or fluorescent light, keep the temperature between 0°C and 35°C
- (3) The polarizer surface should not come in contact with any other object.(we advise you to store them in the container in which they were shipped.)
- (4) Environmental conditions:
 - Don not leave them for more than 168hrs. at 70°C
 - Should not be left for more than 48hrs. at -20°C.

3.13. SAFETY

- (1) It is recommended to crush damaged or unnecessary LCD into pieces and wash them off with solvents such as acetone and ethanol, which should later be burned.
- (2)If any liquid leaks out of a damaged glass cell and comes in contact with the hands, wash off thoroughly with soap and water.

3.14. LIMITED WARRANTY

Unless agreed between TINSHARP and customer, TINSHARP will replace or repair any of its LCD modules which are found to be functionally defective when inspected in accordance with TINSHARP LCD acceptance standards (copies available upon request) for a period of one year from date of shipments. Cosmetic/visual defects must be returned to TINSHARP within 90 days of shipment. Confirmation of such date shall be based on freight documents. The warranty liability of TINSHARP limited to repair and/ or replacement on the terms set forth above. TINSHARP will not be responsible for any subsequent or consequential events.

3.15. RETURN LCM UNDER WARRANTY

No warranty can be granted if the precautions stated above have been disregarded. The typical examples of violations are:

- Broken LCD glass.
- PCB eyelet's damaged or modified.
- PCB conductors damaged.
- Circuit modified in any way, including addition of components.
- PCB tampered with by grinding, engraving or painting varnish.
- Soldering to or modifying the bezel in lay manner.

Module repairs will be invoiced to the customer upon mutual agreement. Modules must be returned with sufficient description of the failures or defects. Any connectors or cable installed by the customer must be removed completely without damaging the PCB eyelets, conductors and terminals.

4. DATE CODE RULES

4-1. DATE CODE FOR SAMPLE

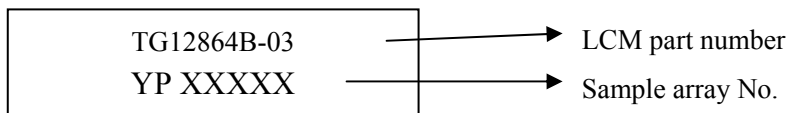

YP: meaning sample

4-2. DATE CODE FOR PRODUCTION

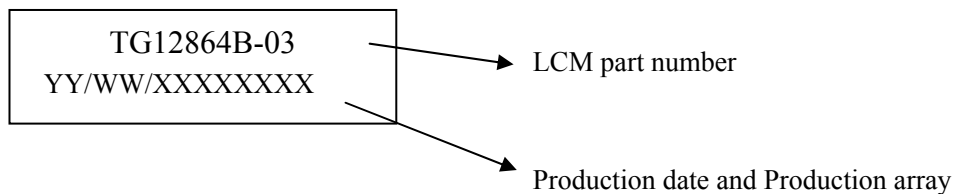

A. TG12864B-03 represents LCM part number

C. YY/WW represents Year, Week

YY—Year WW—Week

XXXXXXXX—Production array No.

END